

ALLEN&HEATH



Reference Guide

Firmware V1.4.0

1. Important information	5
2. Introduction	6
3. Updating firmware	7
4. Operational Overview.....	8
4.1 Physical control of the SQ.....	8
4.2 Channel types	9
4.3 On-screen parameters, menus and pop-ups.....	9
4.4 On-screen title bar.....	10
4.5 Home screen.....	11
4.6 Diagnostics.....	11
4.7 Basic workflow concepts	12
4.8 Screens Reference	13
5. Connections	15
5.1 Local inputs.....	15
5.2 Local outputs.....	15
5.3 SLink	16
5.4 USB.....	16
5.5 Network.....	16
5.6 I/O Port.....	16
5.7 Footswitch.....	16
6. I/O Patching	17
6.1 Local	18
6.2 SLink.....	18
6.3 ME systems.....	19
6.4 USB.....	19
6.5 I/O Port.....	19
6.6 Tie Lines.....	20
6.7 Socket Control.....	20
7. Processing	21
7.1 Preamp (input channels)	22
7.2 Preamp (mix channels)	25
7.3 Gate (input channels).....	26
7.4 Insert	28

7.5 GEQ (mix channels).....	29
7.6 HPF and PEQ	31
7.7 Compressor.....	32
8. Routing.....	35
8.1 Direct out.....	36
8.2 Mix send and balance settings	37
8.3 DCA/Mute Groups.....	38
8.4 Send levels and mix assignments	39
8.4 Matrices	40
9. Metering	41
9.1 PAFL LED Meter.....	41
9.2 Input/FX/Output Meters	41
9.3 RTA.....	42
9.4 Other Metering	42
9.5 Chromatic Channel Metering.....	43
10. FX Engines.....	44
10.1 Using FX buses and returns.....	44
10.2 Loading units and presets	45
10.3 Adjusting parameters	45
10.4 Sending to FX from other sources.....	46
10.5 FX Levels and PEQ.....	47
10.6 RackExtra FX Types	48
11. Saving and Recalling Shows/Scenes/Libraries	50
11.1 Scene manager.....	51
11.2 Global Filters	53
11.3 Safes.....	56
11.4 Libraries	56
11.5 Data transfer (USB/MixPad).....	58
12. Setup.....	62
12.1 Strip assign	62
12.2 Input/Mix stereo assign	63
12.3 Mix bus configuration	64
12.4 SoftKeys/SoftRotaries	65

12.5 Footswitch	68
12.6 Surface Preferences	69
12.7 PAFL	70
12.8 Talkback settings	72
12.9 Signal Generator	73
12.10 Audio Sync and AES sample rate	74
12.11 I/O Port.....	75
12.12 Mixer Role and Master Fader Mode.....	76
12.13 Input Ganging.....	77
12.14 Network Setup.....	78
12.15 User Permissions	79
13. SQ-Drive and USB-B	82
13.1 SQ-Drive stereo recording and playback	83
13.2 SQ-Drive multitrack recording and playback	85
13.3 Connecting to a computer	87
14. MIDI and DAW Control	88
14.1 MIDI channel and MMC	88
14.2 MIDI fader strips.....	89
14.3 DAW Control	89
14.4 MIDI from Soft Controls.....	89
15. Automatic Microphone Mixing (AMM)	90
15.1 AMM Input Assign	90
15.2 AMM Overview.....	91
15.3 AMM Setup	92
16. Add-ons.....	93
17. Mix/System Reset	94
17.1 Reset Mix Settings	94
17.2 System reset	97
17.3 Fader Calibration.....	97
18. Block Diagrams	98
19. Specifications	100
20. Warranty Information.....	105

1. Important information

Safety

Before powering on the SQ, read the safety instructions sheet (AP9240/CL1-1) supplied with the unit. For your own safety and that of the operator, technical crew and performers, follow all instructions and heed all warnings included in these documents and printed directly on the equipment.

Ventilation

Do not obstruct the sides of the SQ, or any of the air vents when in use. Adequate ventilation is required for the cooling fans especially.

Support

For further support with SQ, please visit support.allen-heath.com, or contact your local distributor.

Registration

To be kept informed of updates, the latest firmware and new releases for the SQ range, register your SQ at www.allen-heath.com/registerSQ

Firmware updates and apps

Visit www.allen-heath.com to obtain the latest version of firmware, release notes and reference guide.

Firmware releases contain important updates and performance enhancements and are also required for access to the latest DEEP Processing units.

The firmware on the SQ and all app versions must have the same major release number. This is the first two digits of each release number.

i.e. 1.1.3 and 1.1.5 = compatible

1.1.3 and 1.2.3 = not compatible

2. Introduction

Welcome to the SQ Reference Guide.

Designed for applications where high-quality audio mixing and processing is required in a compact and reliable unit, and built on an Allen & Heath XCVI core, the SQ series of digital mixers feature 96kHz variable bit-depth processing and ultra-low latency.

All SQ models can be used standalone or expanded with a range of remote audio units and option cards. They can also be customised with additional processing options.

Having the same processing core means all models have the same mixing capabilities, and so this guide is generalised. Where necessary, it will be noted which model is being discussed. The differences are as follows:

Model	Faders	Preamps	XLR Outputs	SoftKeys	SoftRotaries
SQ-5	16+master	16+talkback	12	8	0
SQ-6	24+master	24+talkback	14	16	4
SQ-7	32+master	32+talkback	16	16	8

3. Updating firmware

- 1) Insert a new or formatted USB drive into the SQ-Drive port on the front of the SQ.
- 2) Press the **'Utility'** screen key and select **'USB Utility'**.
- 3) In the **'Status/Format'** tab, both windows should say 'Ready'. If they do not, you will need to ensure you are in the correct USB mode.
[To switch between USB B and SQ-Drive modes, press the **'I/O'** screen key, then touch the **'USB'** tab above the routing matrix. The USB Source button is displayed at the top left of the grid and touching this will switch between the modes. To update the firmware, the button should read 'SQ-Drive'.]
- 4) Press the **'Format'** button and follow the on-screen instructions to format the drive, this will clear all data and set up the SQ-Drive folder structure.
- 5) Once formatted remove the drive and connect to a Windows or Mac computer.
- 6) Download the latest version of firmware from www.allen-heath.com, ensuring you choose the correct version for the SQ model you wish to update.
- 7) Unzip/expand the downloaded ZIP file and copy the firmware file (which has a .bin suffix) to the root of the USB drive, do not place it in any of the folders. Ensure there is only one firmware file on the USB drive at any one time.
- 8) Safely eject the drive and re-insert into the SQ.
- 9) Now press the **'Utility'** screen key, select **'USB Utility'** and touch the **'Firmware Update'** tab.
- 10) This screen will display the firmware version found on the USB drive. Touch the **'Update'** button to begin the update process.
- 11) Follow the on-screen instructions and touch the **'Reset'** button when prompted to reboot the SQ and complete the firmware update.
- 12) Check the displayed firmware version on the home screen or press the **'Utility'** screen key and select **'General'**. The firmware version is displayed in the **'Diagnostics'** tab.

4. Operational Overview

4.1 Physical control of the SQ

Keys – All keys are labelled, and most illuminate to show when they are active. All perform specific functions, aside from the 'SoftKeys' which are user assignable.

Faders – There are 6 layers of assignable fader strips. For all inputs and FX returns the fader controls the send level of this channel to the selected mix. FX Send, Mix (Aux/Group) and Matrix faders control master levels. DCA faders control the level of the DCA groups, and MIDI faders send MIDI level messages. All fader strips are also used by the GEQ 'Fader Flip' function.

Rotary Encoders (Rotaries) – These illuminate when active and are used to adjust various parameters. Most are dedicated to parameters for the currently selected channel or mix, though one is for use with the touchscreen. The SQ-6 and SQ-7 feature additional 'Soft Rotaries' which are user assignable.

Touchscreen – The touchscreen allows simple user interaction through on-screen buttons and menus. Parameters can also be selected on-screen and adjusted using the touchscreen rotary. When a parameter is selected, it will turn yellow on the screen, and the touchscreen rotary will illuminate to indicate it can be used.

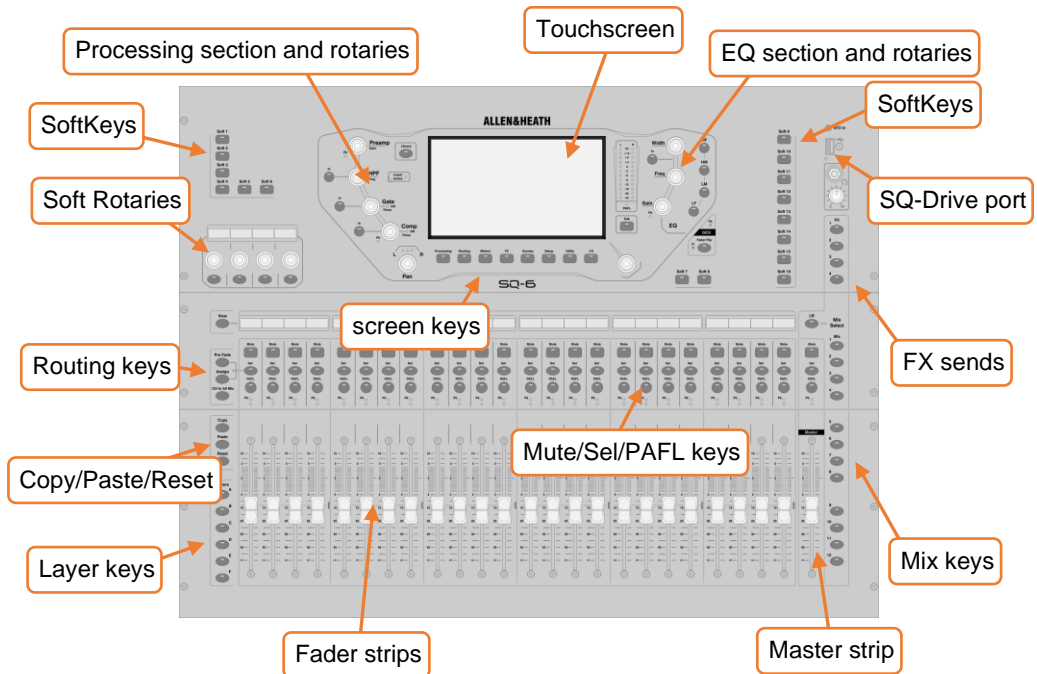

4.2 Channel types

Input channels – 48 input channels with processing. These can be sourced from local, remote or digital connections, and mixed to any output.

Main LR – This is the main mix. All post-fader modes and options follow this mix.

Mix channels – 12 stereo mix channels with processing that can be used as either auxiliaries or groups.

FX sends – 4 FX send buses are included for use with the FX engines.

FX Returns – 8 stereo dedicated return channels for the FX engines.

Matrix – 3 stereo matrix buses that can be made up of a combination of other buses.

DCA – 8 ‘Digitally Controlled Amplifier’ channels for adjusting the level and mutes of multiple channels with one set of controls.

MIDI – 32 channels which send MIDI control data using MIDI over USB and MIDI over TCP/IP.

4.3 On-screen parameters, menus and pop-ups

Adjustable parameters and selections – These are displayed as white text on a black background. Values are displayed as text as well as in a bar.

Libraries – Where available, pressing the ‘**Library**’ key displays a library window, allowing you to store or recall settings for things such as FX units, channel processing or input patches. Presets are stored in the Factory library, and a User library is provided to store your own settings. Libraries are also used to load FX units, through the loading of a preset.

 Where a library is available, it is noted with the following symbol –



 See the full list of library types in the [Libraries](#) section.

Menu lists – With short lists, touch an option to select it. Longer lists can be navigated by highlighting an option and using the touchscreen rotary to scroll through all available options. Where it is not possible to select a list item (as in user permissions lists for example) you may touch and drag on screen.

An ‘X’ is displayed to the top right of most pop-up menus, touch this to close the pop-up.

Keyboard – An on-screen keyboard is displayed when entering names or numbers. Touch and hold ‘A’ (shift) to enable caps lock. Touch ‘Apply’ or ‘OK’ to set the name or number. Touch the ‘X’ at the top right of the keyboard to close it. The standard keyboard has a separate numerical keyboard, and when entering hex, a hex-only keyboard is shown. When entering a Channel Name, touch the colour button to choose a channel colour.

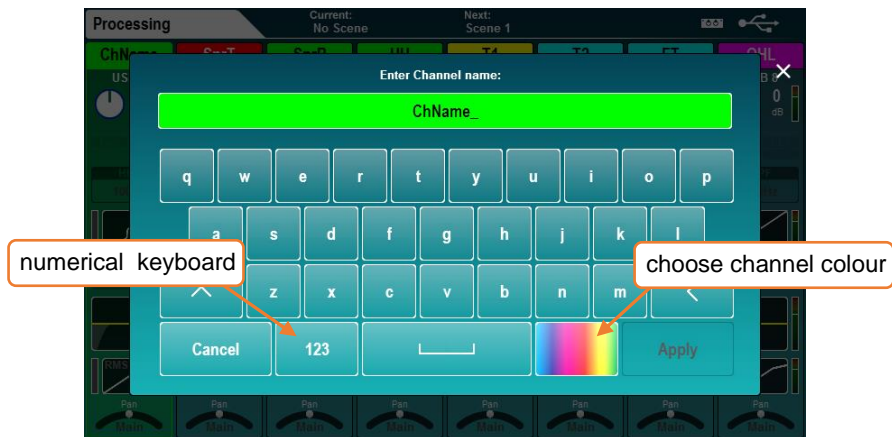

Confirmation – Certain actions require confirmation. Where there is an option to apply or cancel changes, buttons will show as active on-screen. In some cases, a pop-up with more information and choices will be displayed.

4.4 On-screen title bar

The title bar is always visible at the top of the screen, from left to right it displays the following information:

- The title of the currently selected window.
- The currently loaded scene.
- The next scene to be recalled.
- An SLink port symbol (when an SLink connection is available).
- A red cross when an error is detected (tap on this to see a pop-up window with the detected error).
- An I/O Port symbol (when an option card is fitted).
- A USB symbol when a USB device is connected to the SQ-Drive port. This is replaced with transport symbols when using SQ-Drive for audio recording or playback.

4.5 Home screen

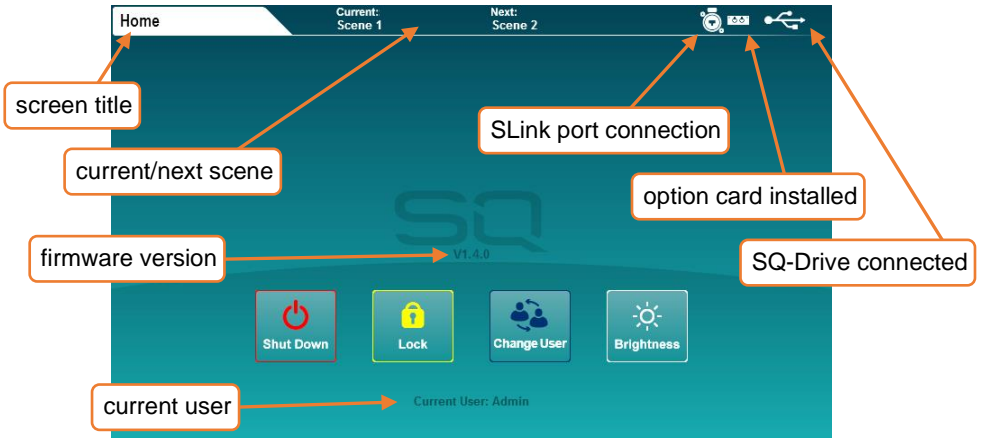

This is the first screen shown when powering on the SQ. It is also shown when no channels are selected, and **'Processing'** or **'Routing'** screen keys are active.

- ⓘ Pressing the **'Processing'** or **'Routing'** screen keys in bank view will deselect the currently selected channel and return directly to the home screen.

'Shut Down' – Touch to shut down the SQ.

'Lock' – Touch to lock the SQ surface and prevent adjustments.

'Change User' – Touch to change to another active user.

'Brightness' – Touch to go directly to the SQ brightness settings.

4.6 Diagnostics

To get to the diagnostics, press the **'Utilities'** screen key and touch the **'General'** tab. This displays important information about the SQ, including the current IP address for connecting via TCP/IP, and the unique DNA code for registration and add-ons.

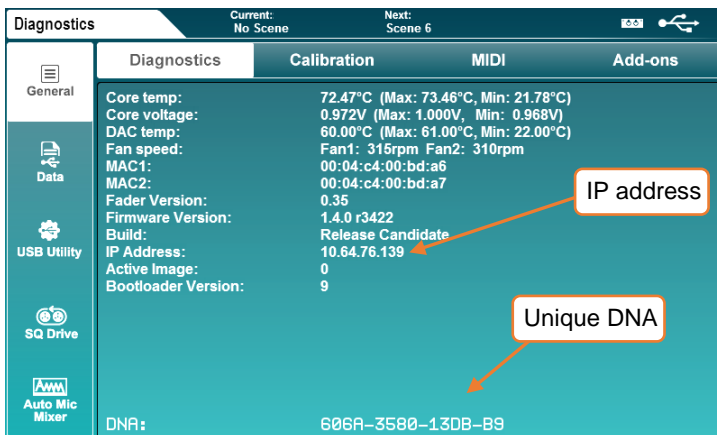

- Press **'LR'**, **'Mix'** or **'FX'** key to present send levels for the selected Mix on the Fader Strips.
Use the layer keys to move through the 6 layers of faders and adjust individual levels.
The Master strip controls the master send level of the selected Mix/FX.
 - Select a strip by pressing a **'Sel'** key. The physical controls can now be used to adjust parameters for the selected strip.
 - Go to the **'Processing'** screen to see an overview of the processing for the selected strip.
Touch on any part of the processing to see a detailed view, then touch a parameter on-screen and use the touchscreen rotary to adjust.
 - Mute keys are illuminated when a strip is muted.
By default, **'PAFL'** (**Pre/After Fade Listen**) keys allow you to route one channel at a time to the PAFL bus/Headphone output.
 - Mix sends set to 'Post-Fade' follow the LR send levels. To toggle channels between 'Pre-Fade' and 'Post-Fade' for the selected Mix, hold the **'Pre Fade'** key and use **'Sel'** keys.
To assign or un-assign a strip from the currently selected mix, hold the **'Assign'** key and use **'Sel'** keys.
 - Pressing and holding the **'CH to All Mix'** key will display the send levels for the currently selected strip across the main fader strips.
 - Press the **'FX'** screen key to view and adjust the FX engines.
Use the **'Library'** key to recall FX types and presets - change parameters by selecting them on-screen and using the touchscreen rotary.
FX buses 1 to 4 send to FX engines 1 to 4 by default.
FX Return channels can be routed to Mixes in the same way as stereo input channels.
 - Hold the **'Copy'** key and press an **'In'** key, a **'Sel'** key or a **'Mix'** key to copy parameters or sends.
Hold the **'Paste'** key and press a **'Sel'** key or Mix key to paste the processing or send assignments to another channel.
Hold the **'Reset'** key and press an **'In'** key, a **'Sel'** key or a **'Mix'** key to reset parameters.
 - Press the **'View'** key to momentarily show alternative information on the channel strip and Soft Rotary LCD's. Press multiple times to see different information and press and hold to display the information until the key is released.
-  Information on the initial state of the SQ can be found in the [Reset Mix Settings](#) section of this guide.

4.8 Screens Reference

Screen Key	Option 1/Left Tabs	Option 2/Top Tabs
Processing	Name, Preamp (input), Ext In (mix), Gate (input), Insert, GEQ (mix), PEQ, Compressor	Bank/Processing View
Routing	Name, Direct Out/Group/Aux Snd/FX Snd, DCA/Mute Assign, Mix Sends, FX Sends (input)/Matrix Sends (mix)	Bank/Assign and Level View
Meters	Input Meters	N/A
	FX Meters	
	Mix Meters	
	RTA	
	Channel Meters	
FX	FX Engines 1-8	Front/Back Panel
Scenes	Scene Manager	N/A
	Global Filter	Input/FX
		Mix
		Other
	Safes	Inputs
		FX
Mix		
Setup	Audio	PAFL
		Talkback
		SigGen
		Audio Sync
		I/O Port
	Surface	Strip Assign
		Soft Controls
		Footswitch
		Surface Prefs
	Mixer Config	Input Stereo
		Mix Stereo
		Bus Config
		Role
	Ganging	Gangs 1-8
	Network Setup	N/A
	Users	User Settings
		Setup
Parameters		
Control		

Utility	General	Diagnostics
		Calibration
		MIDI
		Add-ons
	Data	Shows
		Scenes
		Libraries
		Sync
	USB Utility	Status/Format
		Firmware Update
	SQ-Drive	Stereo
		Multitrack
	Auto Mic Mixer	Overview
		Input Assign
Setup		
I/O	Inputs/Input channel	Input sources
	Inputs/Mix Ext In	
	Outputs/IP Direct Out	Output destinations
	Outputs/Mix Out	
	Outputs/Rack FX	
	Outputs/Monitor Out	
	Tie Lines/All Input Sources	All Output Destinations

5. Connections

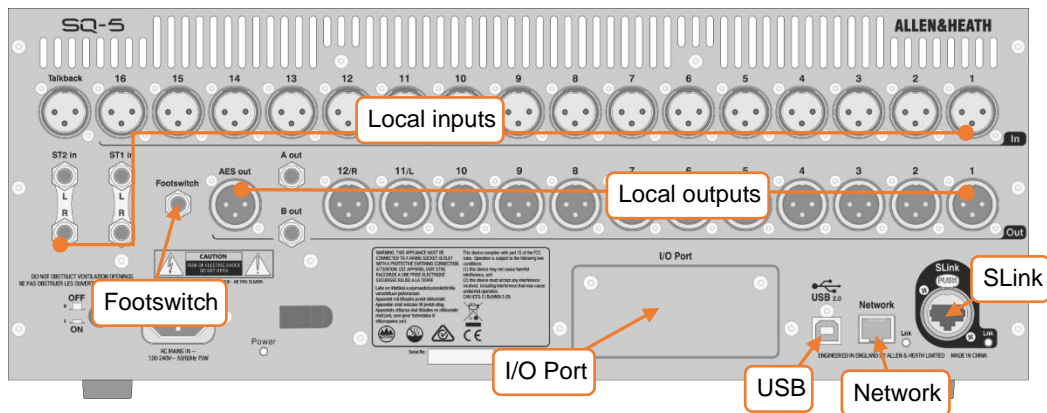

5.1 Local inputs

Mono mic/line (XLR female) – These are numbered and accept balanced mic or line level signal. Gain, Pad and 48v Phantom Power are controlled digitally.

Talkback (XLR female) – Identical to mono mic/line inputs. Intended for communication from the desk position, but can also be used as an additional input.

ST1, ST2 (1/4" TRS jack) – Labelled as stereo pairs, these can also be used as mono line level balanced inputs.

ST3 (TRS Mini jack) – Located on the surface of the SQ, this can be used with a line level source, such as a portable media player, laptop, tablet or smartphone, using a standard stereo mini jack cable.

5.2 Local outputs

Mono line (XLR male) – Line level outputs for sending mixes or direct outputs. These are numbered, and fully assignable. With default settings, the LR mix is sent to 11&12, as labelled.

A/B mono line (1/4" TRS jack) – Two assignable line level outputs, presented on balanced jack sockets for convenience.

AES digital (XLR male) – Stereo digital output clocked to SQ. For connection to equipment with a digital input.

Headphone (1/4" TRS jack) – Located on the surface of the SQ, with dedicated level control. Fed from the PAFL bus.

5.3 SLink

Digital multichannel (Neutrik etherCON) – For expanding the SQ using Allen & Heath Remote Audio Units. Mode switchable between dSnake, DX and gigaACE/GX protocols.

Protocol	Sample Rate	Max Inputs	Max Outputs
dSnake	48kHz	40	20 (+40 ME)
DX	96kHz	32	32
gigaACE/GX	96kHz	128	128

❗ SLink does not support multiple protocols on a single connection.

❗ Check www.allen-heath.com for the full list of supported configurations.

5.4 USB

SQ-Drive – Located on the surface of the SQ. Can be used to connect USB ‘pen/stick’ drives, or portable HDD’s or SSD’s. Used for storing and recalling data, firmware updates and stereo or multitrack audio recording and playback.

USB-B – For connection to a Windows or Mac computer, in order to use the built-in 32x32 audio and MIDI interface.

❗ See the [SQ-Drive and USB-B](#) section for more information.

5.5 Network

This is used to connect the SQ to a wireless router, access point or local area network, allowing the SQ to transmit and receive control data. For use with Allen & Heath SQ apps, and for MIDI over TCP/IP.

5.6 I/O Port

For the connection of SQ option cards, allowing expansion and connectivity using Allen & Heath (SLink) or third-party protocols (including Dante and Waves).

❗ See www.allen-heath.com for all available option cards.

5.7 Footswitch

Connect a single or dual, momentary or latching footswitch, and use to control functions such as mutes, tap tempo or scene changes.

❗ See the [Footswitch Setup](#) section for more information.

- Available patching blocks are grey and are filled light grey when patched.
- Currently unavailable patching blocks are dark grey and striped light grey when patched.

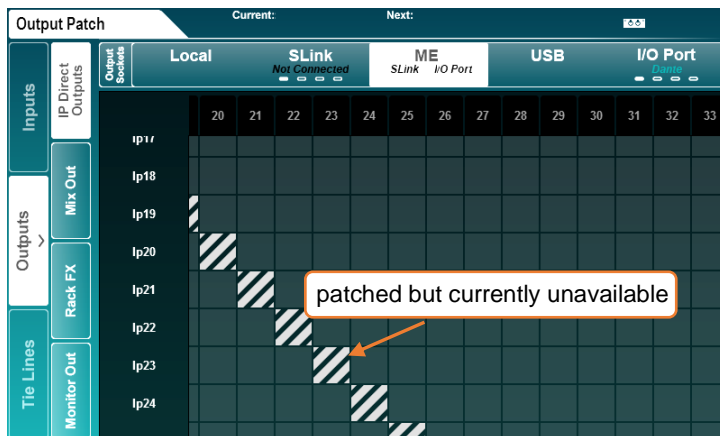

- ❗ All patching to a currently disconnected device will become active once the device is connected.

Input Libraries –

Pressing the 'Library' key on the surface when the 'Inputs' tab is active will display the input libraries.

These can be used to store input patches for different setups and provide a quick way to switch patching for virtual soundcheck.

Factory presets for one-to-one patching are provided for quick setup.

- ❗ Input libraries store and recall **all** input patching, not just the currently selected source.

6.1 Local

The local input and output options in the I/O screen match the analogue input and output socket labels on the SQ.

6.2 SLink

The SLink port is compatible with dSnake, DX and gigaACE/GX. It switches between these modes, so multiple protocols over a single connection are not supported.

The current mode is shown on the tab in blue text unless nothing is connected, in which case **'Not Connected'** is displayed.

Check www.allen-heath.com for the full list of supported configurations.

Touch the tab multiple times to display channels 1-32, 33-64, 65-96 or 97-128. There are four marks on each tab to show which screen is currently displayed.

6.3 ME systems

ME-U, ME-1 and ME-500 units use the dSnake protocol, so can either be connected directly, or connected to monitor or expander ports of an AR2412 or AB168.

The ME patching is applied to either the SLink port, an SLink option card, or both. The **'SLink'** and/or **'I/O Port'** text on the **'ME'** tab are displayed in white when patching is active on either port.

- ❗ ME-1 units accept 40 total channels, ME-500 units accept 16 mono or stereo channels, stereo channels are set on the SQ in [Mixer Config](#) settings.

6.4 USB

The screenshot shows the 'Output Patch' interface with the 'USB' tab selected. The patching matrix is as follows:

Inputs	Local	SLink	ME	USB	I/O Port
IP Direct Outputs		Not Connected			
Outputs					
Tie Lines					

Matrix Rows: SQ-Drive, Aux7 R, Aux8 L, Aux8 R, Main L, Main R, Mtx1 L, Mtx1 R, Mtx2.

Callouts: 'USB Source' button, 'USB channel number' header, 'Main R out to SQ-Drive (USB) channel 2' cell, 'source type/channel' header.

USB patching is for SQ-Drive or USB-B streaming connections.

SQ-Drive uses input and output USB channels 1 to 16 and USB-B uses input and output USB channels 1 to 32.

- ❗ SQ-Drive and USB-B Source modes are mutually exclusive. When the USB tab is active, the **'USB Source'** selection button will be displayed at the top left of the patching matrix, touch this to switch modes.

6.5 I/O Port

Used for patching to SQ option cards fitted in the I/O Port.

The current option card protocol is shown on the tab in blue text unless nothing is connected, in which case **'Not Connected'** is displayed.

- ❗ Touch the tab multiple times to display channels 1-32, 33-64, 65-96 or 97-128. There are four marks on each tab to show which screen is currently displayed.
- ❗ Note that when patching to an option card such as Dante, you are patching the SQ to the option card. Further patching between devices may then be required.

6.6 Tie Lines

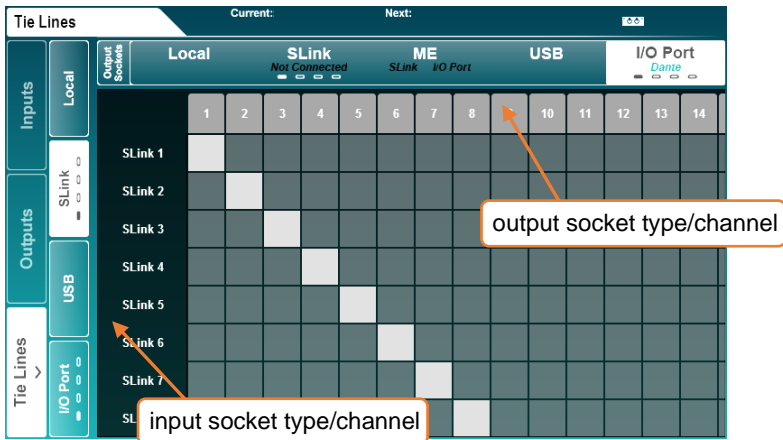

Tie lines are used to patch connections between source and destination points without using channel processing.

All possible inputs/sources are displayed on the left and all possible outputs/destinations are displayed at the top.

This allows you to pass audio directly from any available input source to one or multiple outputs and has many applications including:

- Sending unprocessed ('Post Preamp') audio whilst simultaneously sending processed audio from the direct out (such as when multitrack recording and using a ME personal monitoring system at the same time).
- Setting up digital splits for front of house and monitor, or broadcast setups.
- Sending an ambient microphone which is not required in the main mix to USB or option card for recording without using up a channel.

6.7 Socket Control

Touching a socket number at the top of the patching matrix opens the socket control pop-up with the following options for connected local or expander sockets.

Analogue input = 48V, Pad and Gain
AES input = SRC Bypass option
AES output = Output Sample Rate

- ⓘ To protect preamp settings for sockets not assigned to input channels on scene changes, block 'Tie Line Only Preamps' in Global or Scene [recall filters](#).

7. Processing

Press any **'Sel'** key to select a channel. The physical controls and keys around the touchscreen will illuminate to show they are active and can be used to adjust parameters for the selected channel.

Press the **'Processing'** screen key to display the processing 'bank view'.

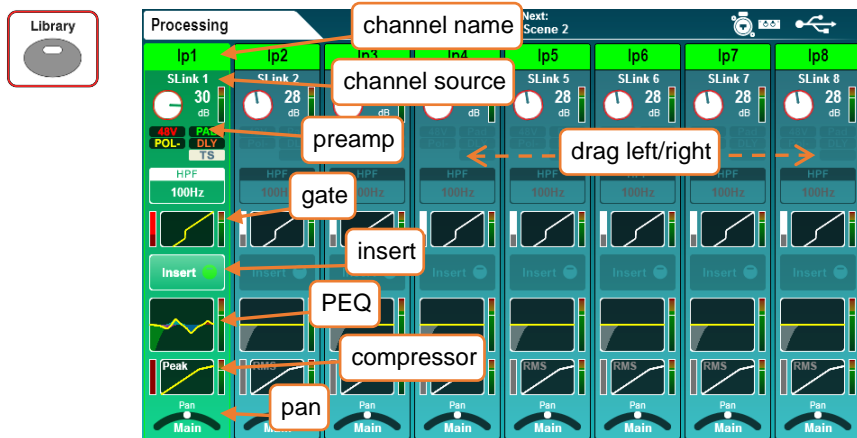

This gives the processing overview for 8 channels at once, with the selected channel highlighted. The view will automatically change if a channel is selected which is out of view, though you can also touch and drag to see all channels for the current layer. The selected mix channel is displayed to the far right.

- Touch a channel name to rename or change channel colour.
 - Touch **'Apply'** to set the name and colour (it will now be displayed on the channel LCD display). The keyboard will remain on screen when other **'Sel'** keys are pressed, to speed up the naming of multiple channels.
 - Touch any processing 'block' to view and adjust it in detail. The channel overview will continue to be shown at the left of the screen. Selecting another channel will allow you to adjust the same parameters on the newly selected channel.
 - Touch the active block or press the **'Processing'** key to return to the bank view.
 - The order of audio processing is displayed from top to bottom.
- ❗ HPF is displayed in bank view in the correct order of processing (post-preamp), though it is viewed and controlled on the PEQ processing page for convenience.
- ❗ DCA channels display a list of up to 28 'members'. If there are more members than this, then '...' will appear at the bottom of the list.

7.1 Preamp (input channels)

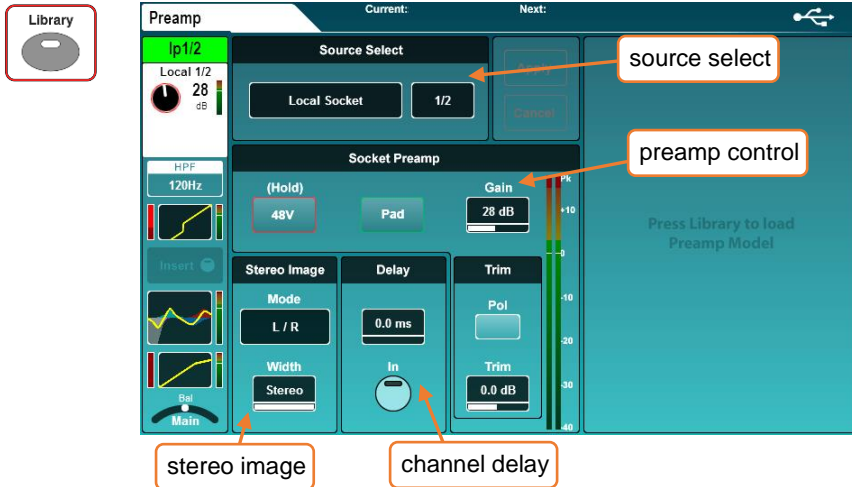

Source Select –

- Touch the source type to select from a list of sources.

Unassigned = Channel has no source.

Local Socket = A socket on the rear of the SQ.

SLink Socket = A device connected to the SLink port (AR, AB and DX units or another console).

USB Port = Either SQ-Drive or USB-B (depending on [mode](#)).

IO Port = SQ Option card.

Signal Generator = The built-in [signal generator](#).

- Touch the source channel and use the touchscreen rotary to scroll through channels.

Socket Preamp –

- Touch and hold the '48V' button to switch phantom power on or off (channel will be automatically muted when switching this).
- Touch the 'Pad' button to switch the -20dB pad in or out.
- Select 'Gain' or 'Trim' parameters to adjust using the touchscreen rotary. Gain can also be adjusted using the dedicated physical control.

Gain = 0dB to +60dB

Trim = -24dB to +24dB

- **i** Gain is for digitally controlled analogue inputs, such as local microphone inputs or those on a Remote Audio Unit. Trim is a purely digital adjustment, for digital or line signal.

- Touch the 'Pol' button to invert the polarity of the input channel.

Delay – In order of processing, the millisecond channel delay is actually located after the compressor. It is presented in the preamp screen as it is usually set at the same time as other 'setup' parameters such as gain, which are not adjusted during mixing.

- Select the value to adjust using the touchscreen rotary.

Input channel delay = 0ms to 341.3ms

- Touch the 'In' button to switch the delay in or out.

Stereo Image – This section is visible only when a stereo input channel is selected. Touch the mode to select from the following options:

L/R = standard left/right.

R/L = switched left/right.

L-Pol/R = standard left/right with switched polarity on left.

R-Pol/L = switched left/right with switched polarity on right.

Mono = left and right fed to both channels.

L/L = left fed to both channels.

R/R = right fed to both channels.

M/S = for decoding a mid/side array (outputs M+S/M-S).

- ⓘ For normal M/S use, the mid signal/microphone should be patched to the odd channel and the side signal/microphone should be patched to the even channel.

The width control can be adjusted in 1% increments from Mono (0%) to Stereo (100%).

DEEP Preamp –

Preamps in the SQ itself and those in Remote Audio Units are accurate and transparent, with fast transients and low THD. However, there are some situations where alternative characteristics may be desirable. Using a DEEP preamp model allows you to add these characteristics, with complete control, and none of the associated limitations or reliability concerns of esoteric equipment.

- When in the channel '**Preamp**' screen, press the '**Library**' key to show the list of preamp models.

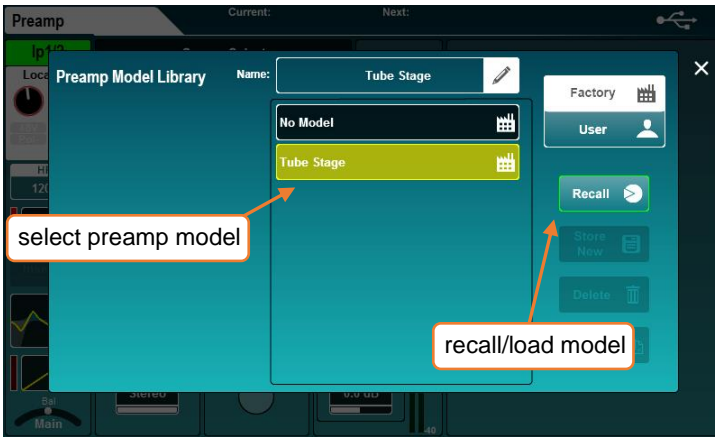

- Select a preamp, then press the '**Recall**' button to load it.



- Touch '**On/Off**' to switch the preamp model on or off.
- Touch any on-screen parameter and adjust using the touchscreen rotary.

7.2 Preamp (mix channels)

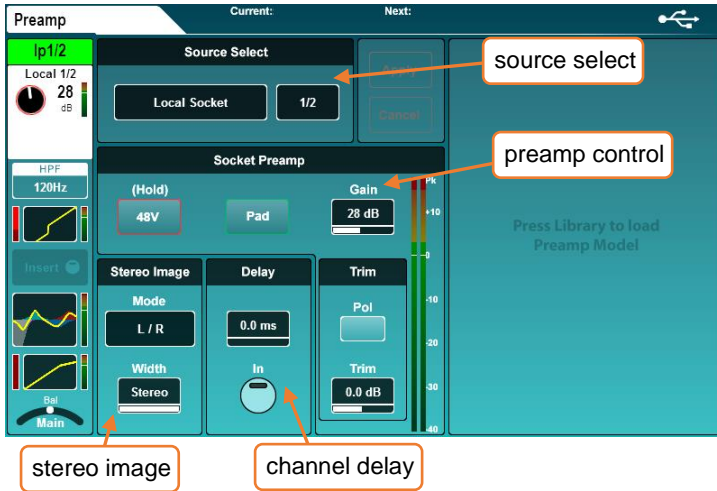

Mix External In –

A 'Mix Ext In' can be added to any mix channel. This enables signals that do not require processing to be added to an individual mix. It is useful when wanting to add a sub mix to a main mix, or for communications.

- ❗ Mono mixes allow mono external inputs and stereo mixes allow stereo external inputs.

Other than the channel delay, all parameters in the preamp section of mix processing relate to the control of the mix external input, including Source Select, Socket Preamp (available when a socket preamp is selected as the source) and Trim. Refer to [Preamp \(input channels\)](#) for more information.

- ❗ The 'Polarity' switch in the Trim section switches the polarity of the assigned 'Mix Ext In' as opposed to the polarity of the mix itself.

Delay – In order of processing, the millisecond channel delay is actually located after the compressor.

- Select the value to adjust using the touchscreen rotary.

Mix channel delay = 0ms to 682.6ms

- Touch the 'In' button to switch the delay in or out.

7.3 Gate (input channels)

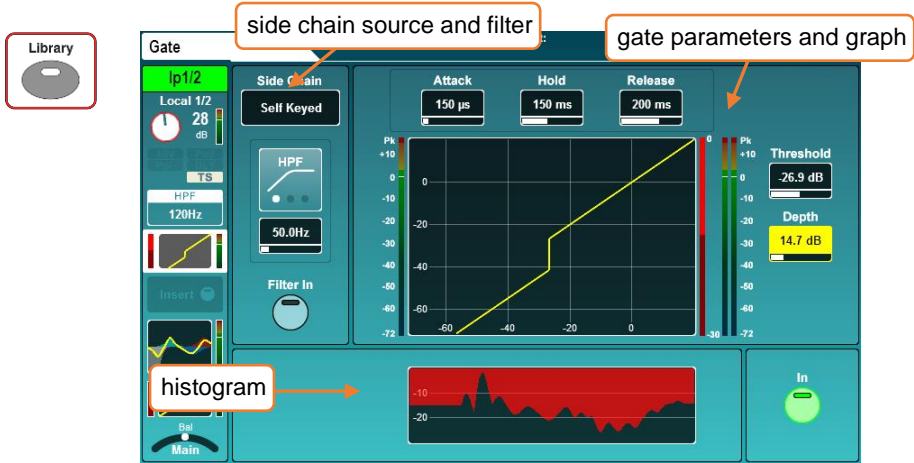

Switch the Gate in or out using either the on-screen 'In' button or the physical Gate 'In' key (to the left of the dedicated Gate threshold rotary).

Side Chain –

- Select either '**Self Keyed**' or side chain the gate from another channel.
-  When using another channel as a side chain input, the signal is sourced after all channel processing, post millisecond channel delay.
- Touch the filter type to switch between HPF/BPF/LPF modes. The '**Filter In**' button engages the filter.
- Touch the frequency value to select it, then adjust with the touchscreen rotary.

HPF Frequency = 20Hz to 5kHz
BPF Frequency = 120Hz to 10kHz
LPF Frequency = 120Hz to 20kHz

Parameters and graph –

- The graph displays input/threshold on the x-axis and output level on the y-axis to give a visual representation of gate parameter settings.
- The side chain input level is shown on the meter to the left of the graph. Gate action (signal reduction) from 0dB to -30dB is shown on the meter to the immediate right of the graph. When the gate is switched in, this is red, otherwise it is white. The post-gate level is shown to the right of this.

- Adjust parameters by touching to select and then using the touchscreen rotary. Gate threshold also has a dedicated rotary.

Attack = 50 μ s to 300ms

Hold = 10ms to 5secs

Release= 10ms to 1sec

Threshold = -72dB to +18dB

Depth = 0dB to 60dB

Histogram – The histogram shows the previous 12 seconds of gate activity, moving from right to left. As with the reduction meter, when the gate is in, the level reduction (depth) is shown in red, and when out is shown in white/grey.

7.4 Insert

The insert points on SQ can be used to route audio to and from any available I/O sockets, allowing external analogue or digital processing to be inserted into the channel.

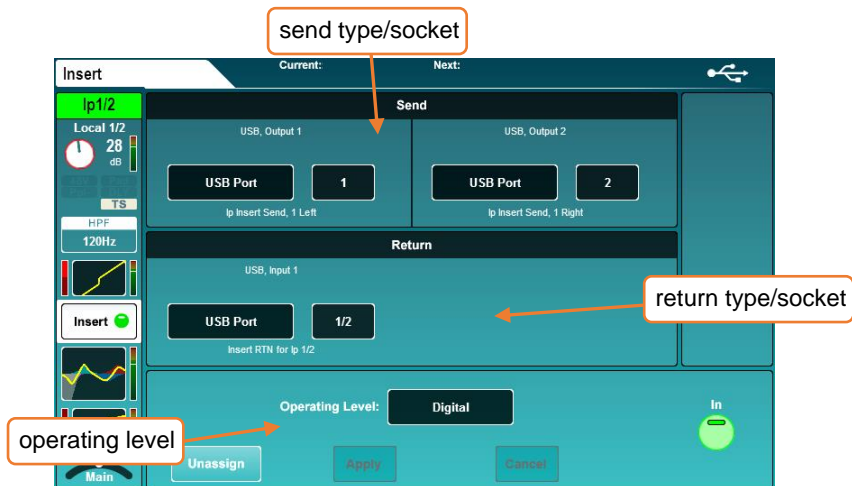

They can also be used with the internal FX engines. See the [FX engines](#) section for more details.

Send – Select destination type and channel for the insert send.

Return – Select source type and channel for the insert return.

Send/Return types = Local Socket, SLink Socket, USB Port, IO Port, FX Unit

Operating level – Select from line level options to match insert type.

Digital = Uncompensated, for use with digital I/O.

Analogue = For use with +4dBu outboard equipment.

-10 dBV = For use with -10dBV outboard equipment.

When a selected channel's insert is assigned and switched 'In', the 'Insert Active' LED will illuminate on the SQ surface.

i Note that insert send and return is not latency compensated.

7.5 GEQ (mix channels)



All mix channels feature a 28-band stereo graphic EQ. With a mix channel selected, and GEQ active, the green 'In' LED in the GEQ section (below the PEQ rotaries) will illuminate.

To make adjustments, touch the on-screen fader for each band and use the touchscreen rotary.

Frequencies (Hz) = 31, 40, 50, 63, 80, 100, 125, 160, 200, 250, 315, 400, 500, 630, 800, 1k, 1.25k, 1.6k, 2k, 2.5k, 3.15k, 4k, 5k, 6.3k, 8k, 10k, 12.5k, 16k
Gain = -12dB to +12dB
Bandwidth = 1/3rd oct (constant)

'Fader Flip' mode - The SQ can also display the GEQ on faders, to allow for quick and accurate adjustment.

- Pressing the GEQ **'Fader Flip'** key shows the graphic EQ on faders, with a frequency band on each fader strip. Pressing the **'Fader Flip'** key a second time on the SQ-5 or SQ-6 displays another set of frequency bands, and a third press will exit the mode.
- Due to having 32 fader strips, the SQ-7 is able to display all 28 frequency bands at once.
- Frequencies are displayed on the channel LCD displays.
- The RTA levels (fed from the PAFL bus) are displayed for each frequency using the Chromatic Channel Metering.

DEEP GEQ – Along with the standard ‘Constant-Q’ GEQ, other DEEP GEQ’s can be added to the SQ. These have unique behavioural characteristics.

Once DEEP GEQ models have been added to the SQ, they can be used in place of the ‘Constant-Q’ GEQ on any mix channel.

i Information on how to add models can be found in the [Add-ons](#) section of this guide.

- Press the ‘**Library**’ key to see the GEQ Library.
- Different GEQ models are recalled from the ‘**Factory**’ library.
- Store and Recall DEEP GEQ user presets using the ‘**User**’ library.

Proportional-Q –

Smooth wide Q which progressively narrows toward maximum cut or boost values.

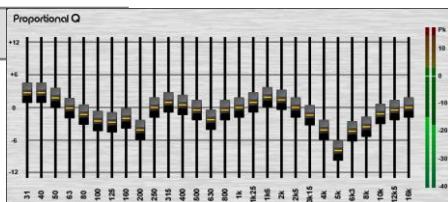

Hybrid GEQ –

A combination of the Proportional-Q and Constant-Q units providing smooth boosts and clinical cuts.

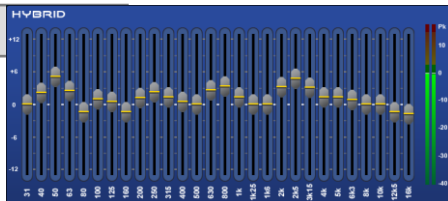

Digi GEQ –

Optimised gain and width to minimise frequency band interaction.

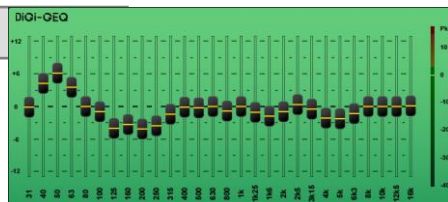

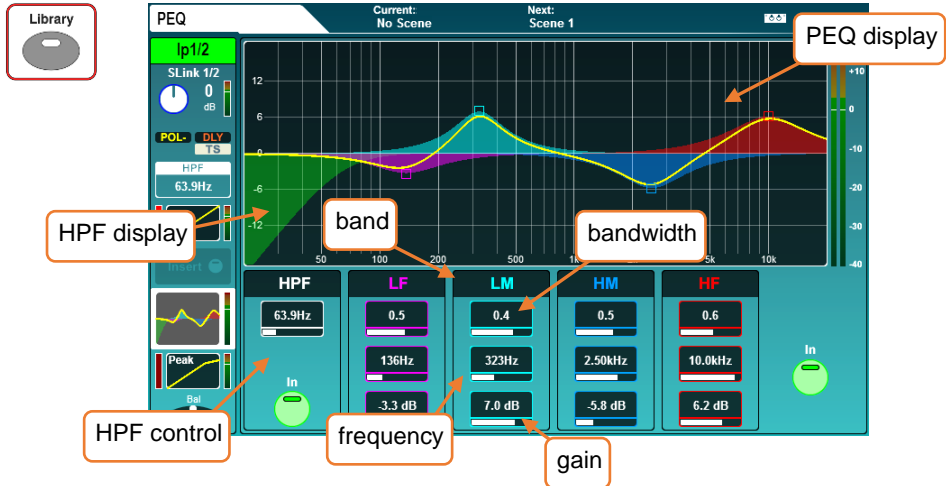

HPF - In order of processing, the High Pass Filter (HPF) is located post-preamp (as in the channel overview). It is displayed in the EQ screen for convenience.

- Switch in or out using the on-screen button, or dedicated HPF 'In' key.
- Touch the HPF value to select it, then adjust it using the touchscreen rotary, or use the dedicated HPF rotary.

HPF Frequency = 20Hz to 2KHz

PEQ -

- The 4-bands of the parametric EQ are labelled to match the physical EQ section on the surface.
- When the PEQ is active, the graphical display is brightly coloured, when inactive, it is greyed out.
- To use the dedicated physical EQ controls, select a band, and use the gain, bandwidth and frequency rotaries to adjust. To adjust on-screen, touch the parameter and use the touchscreen rotary, or touch and drag points on the graph.

Frequency (all bands) = 20Hz to 20kHz

Width (LF, HF) = Shelf, 1.5 oct to 1/9th oct

Width (LM, HM) = 1.5 oct to 1/9th oct

Gain (all bands) = -15dB to +15dB

- ⓘ To avoid accidental switching, the 'Shelf' modes of the LF and HF bands can only be accessed by adjusting the bandwidth/Q control past '1.5' on-screen. It is not possible to set this using the dedicated physical 'Width' rotary.
- ⓘ The frequency band selected on the surface can be set to follow the on-screen selection in [Surface Preferences](#).

7.7 Compressor

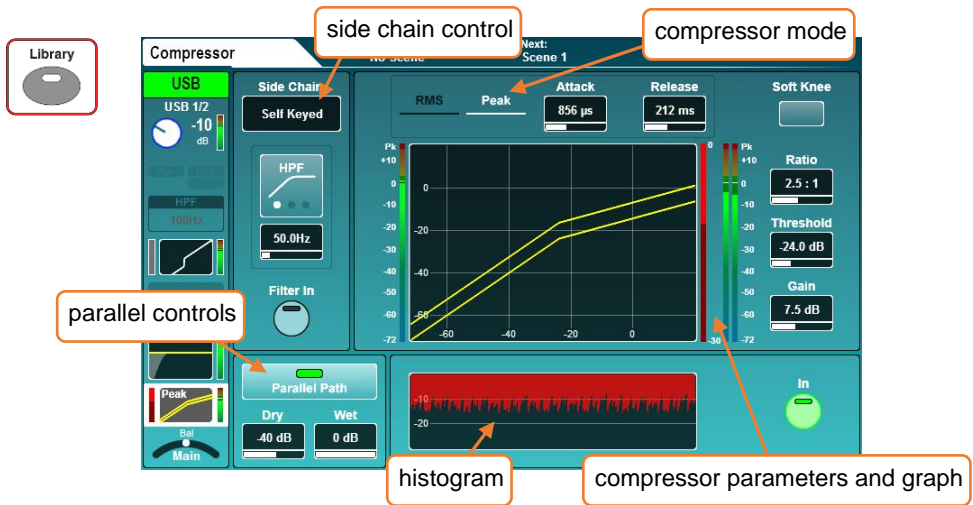

Switch the Compressor in or out using either the on-screen 'In' button or the physical Compressor 'In' key (to the left of the dedicated Compressor threshold rotary).

Side Chain –

- Select either '**Self Keyed**' or side chain the compressor from another channel.
- ❗ When using another channel as a side chain input, the signal is sourced after all channel processing, post millisecond channel delay.
- Touch the filter type to switch between HPF/BPF/LPF modes.
- Touch the frequency to select, then adjust using the touchscreen rotary.

HPF Frequency = 20Hz to 5kHz
BPF Frequency = 120Hz to 10kHz
LPF Frequency = 120Hz to 20kHz

Compressor mode -

There are two detection modes in the standard compressor, RMS (average) and Peak. Touch either mode to toggle between them. The active mode is displayed in white.

Ducker Mode -

Load '**Ducker Mode**' from the Compressor Library. This is a special compressor mode that reduces channel level based on signal from another channel (using the side chain input). Often used on background music with the side chain fed from an announcement microphone.

Soft Knee –

Touch this button to switch on the soft knee setting. This enables a variable ratio which smooths the behaviour of compression around the threshold (this is also displayed on the graph).

Parameters –

- Adjust parameters by touching to select and then using the touchscreen rotary.

Attack = 30 μ s to 300ms

Release = 50ms to 2secs

Ratio = 1:1 (no compression) to Infinity (limiting)

Threshold = -46dB to +18dB

Gain (make-up gain) = 0dB to +18dB

Graph –

- The graph displays input/threshold on the x-axis and output level on the y-axis to give a visual representation of compressor parameter settings.
- The side chain input level is shown on the meter to the left of the graph. Compression (signal reduction) from 0dB to -30dB is shown on the meter to the immediate right of the graph. When the compressor is switched in, this is red, otherwise it is white.
The post-compressor level is shown to the right of this.

Histogram –

The histogram shows the previous 12 seconds of compressor activity, moving from right to left. As with the level reduction meter, when the compressor is in, the level reduction (depth) is shown in red, and when out is shown in white/grey.

Parallel compression –

This allows you to blend (in-line) the compressed signal with the uncompressed signal.

- Touch the '**Parallel Path**' button to switch in or out.
- Touch the Dry/Wet values and adjust using the touchscreen rotary.

Dry/Wet individual level = -infinity to 0dB

DEEP compressors – These are modelled on classic hardware units and have unique tonal and behavioural characteristics.

Once DEEP compressor models have been added to an SQ, they can be used in place of the RMS/Peak compressor on any channel.

i Information on how to add models can be found in the [Add-ons](#) section of this guide.

- Press the **'Library'** key to see the Compressor Library.
- Different compressor models can be recalled from the **'Factory'** library.
- Store and Recall DEEP compressor presets using the **'User'** library.

Opto –

The best characteristics from a range of optical compressors combined into one smooth sounding unit.



16T –

Tight and punchy VCA-based RMS compressor, with natural sounding gain reduction.



16VU –

The classic VCA-based RMS compressor. Musically enhances low-mid frequencies when driven.



Peak Limiter 76 –

Two versions of the renowned FET levelling amplifier. One vintage, one more modern, both with all-button mode.



Mighty –

Transistor array compressor that features a unique attack sound. Capable of massive gain reduction with low distortion.



8.1 Direct out

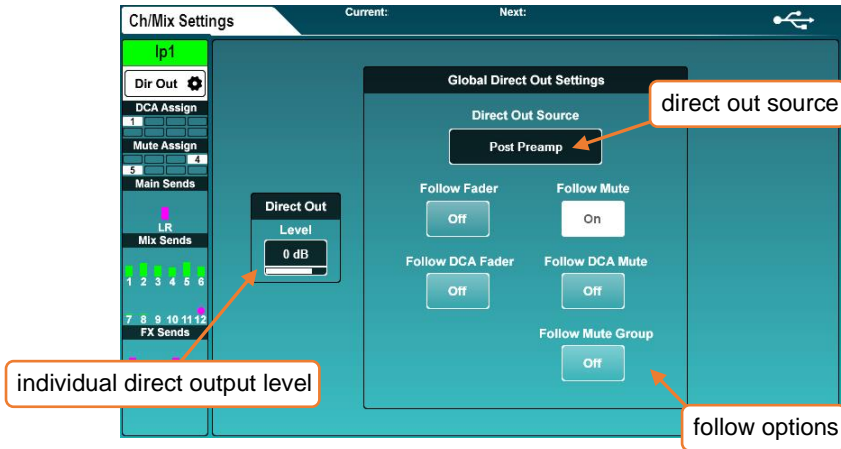

Touch the 'Dir Out' button on any input channel.

This screen shows the direct output level for the selected channel, as well as the global direct out settings which affect all channels. The currently selected channel is displayed on the left.

- Touch the level value and adjust using the touchscreen rotary, this is adjusted individually on each channel.

Direct out level = -inf to +10dB

- Choose whether direct out signals are affected by faders or mutes by touching the on-screen buttons.
- Select the channel 'tap off' point by touching the Direct Out Source value. Each source point is presented in order, and is affected by all preceding processing that is switched in.

Post Preamp = signal is affected only by the preamp gain.

Post HPF = signal is also affected by the high pass filter.

Post Gate = signal is also affected by the gate.

Post Insert Return = signal is also affected by the insert.

Post PEQ = signal is also affected by PEQ.

Post Comp = signal is also affected by compressor.

Post Delay = signal is affected by all channel processing including ms delay.

8.2 Mix send and balance settings

Mix channels have different buttons in place of the **'Dir Out'** button found on the input channels, touch this to see the following options.

Main – (**'Main Snd'**)

- Touch the **'Output Bal'** value and adjust using the touchscreen rotary to adjust the output balance.

Group – (**'Group'**)

- Touch the **'Output Bal'** value and adjust using the touchscreen rotary to adjust the output balance.
- Touch **'All On'** or **'All Off'** button to assign or unassign all channels to the group.

Aux – (**'Aux Snd'**)

- Touch the **'Channel Source'** value to choose the where the aux takes channel signal from. Each source point is presented in order, and is affected by all preceding processing that is switched in.

Post Preamp = signal is affected only by the preamp gain.

Post Insert Return = signal is also affected by HPF, gate and insert.

Post EQ = signal is also affected by PEQ.

Post Delay = signal is affected by all channel processing including ms delay.

- Touch **'All On'** or **'All Off'** button to assign or unassign all channels to the aux.
- Touch **'All Pre'** or **'All Post'** button to set all channel sends to pre-fade or post-fade.

FX – (**'FX Snd'**)

- Touch the **'Channel Source'** value to choose the where the FX send bus takes channel signal from. Each source point is presented in order, and is affected by all preceding processing that is switched in.

Post Preamp = signal is affected only by the preamp gain.

Post Insert Return = signal is also affected by HPF, gate and insert.

Post EQ = signal is also affected by PEQ.

Post Delay = signal is affected by all channel processing including ms delay.

- Touch **'All On'** or **'All Off'** button to assign or unassign all channels to the FX bus.
- Touch **'All Pre'** or **'All Post'** button to set all channel sends to pre-fade or post-fade.

8.3 DCA/Mute Groups

Touch the DCA/Mute Assign block to show assignments for the selected channel.

- Digitally Controlled Amplifiers control the send levels and mutes of multiple channels with a single fader and mute key. DCA's are not buses so they do not carry signal or have processing or metering functionality.
- Mute groups are used to mute multiple channels with a single **SoftKey**.

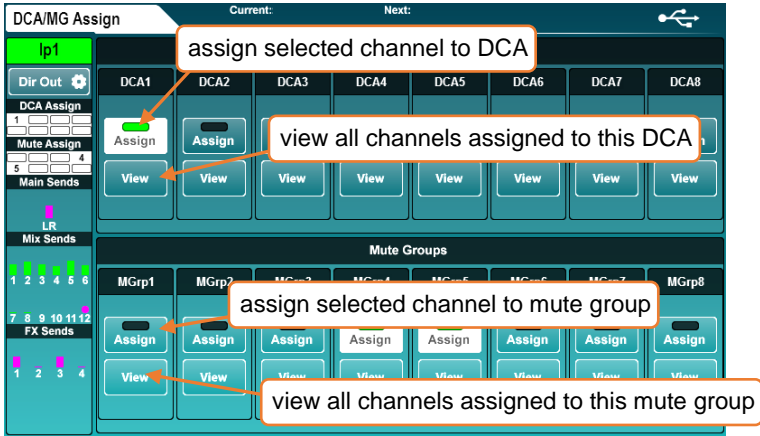

- Touch '**Assign**' buttons to assign or unassign the selected channel to DCA's or Mute Groups.
- Touch the '**View**' buttons to see all channels currently assigned to the DCA or Mute Group.
- Touch and drag up and down in the view window to see all channels.
- Channels can be assigned or unassigned by touching assignment buttons.
- Touch the DCA/Mute Assign 'blacks' to return to the selected channel assignments view.

In both the '**Processing**' and '**Routing**' screens, DCA channels display a list of up to 28 channel 'Members' (channels assigned to that DCA). If there are more members than this, then '...' will appear at the bottom of the list.

- Touch anywhere on a DCA member list to view and assign or unassign channels.
- Pressing the PAFL key on a DCA fader strip is the equivalent of using additive PAFL on every member of the DCA. When engaged, PAFL keys of the DCA members will flash.
- When muting DCA's or Mute Groups, the mute keys of the assigned channels will flash. If a channel is also independently muted, the duration of illumination will change to indicate this.

8.4 Send levels and mix assignments

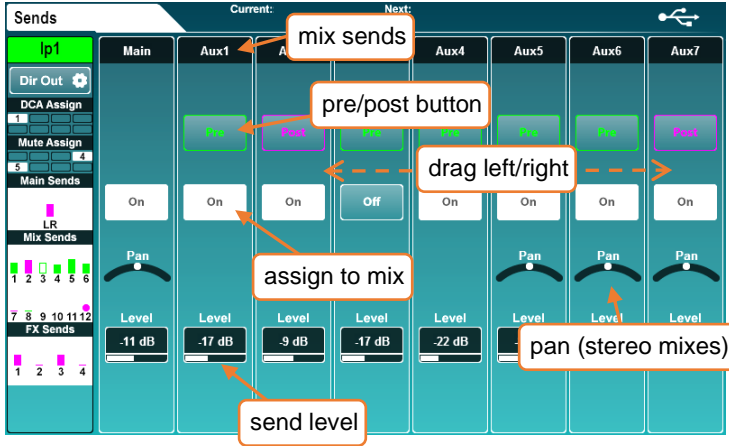

This screen displays all sends and mix assignments for the selected channel.

- Touch and drag left or right to view all mixes and sends.
 - Touch the '**On/Off**' button to assign or unassign the channel to a mix/send or matrix.
 - Touch the '**Pre/Post**' button to set send to either Pre-fade or Post-fade.
 - Touch the '**Pan/Bal**' control and use the touchscreen rotary to set the pan or balance for a send.
 - Touch the '**Level**' value and adjust using the touchscreen rotary, or adjust on faders.
- i** Pressing the momentary '**CH to All Mix**' key displays all send levels for the currently selected channel on the fader strips. You can also hold this key then use the assign or pre-fade keys to change routing for the selected channel.
- i** Holding the '**Assign**' key and pressing the '**Sel**' key of a mix assigns or unassigns all channels.

8.4 Matrices

The SQ features 3 stereo or mono matrix buses. These can be fed by any combination of SQ mixes and routed to all available outputs.

Combining mixes can be useful for several applications including:

- Recording – a single mix or combination of mixes can be recorded with additional mix processing and level control.
- Extra speakers – a matrix can be used to send a duplicate of single mix (often the LR mix) with extra processing and/or added delay. This is useful for 'fill' speakers or to time align ancillary speakers.
- Feeding subwoofers – by routing the main LR mix (Post-Fade) to a matrix and using this to feed subwoofers, the entire system level can be controlled by the LR master send, but the subwoofers have additional processing and level control.

There are three methods for sending a mix to a matrix.

- 1) The matrix sends are shown in the send levels and assignments screen when a mix is selected.
- 2) The matrix sources are shown in the send levels and assignments screen when a matrix is selected.

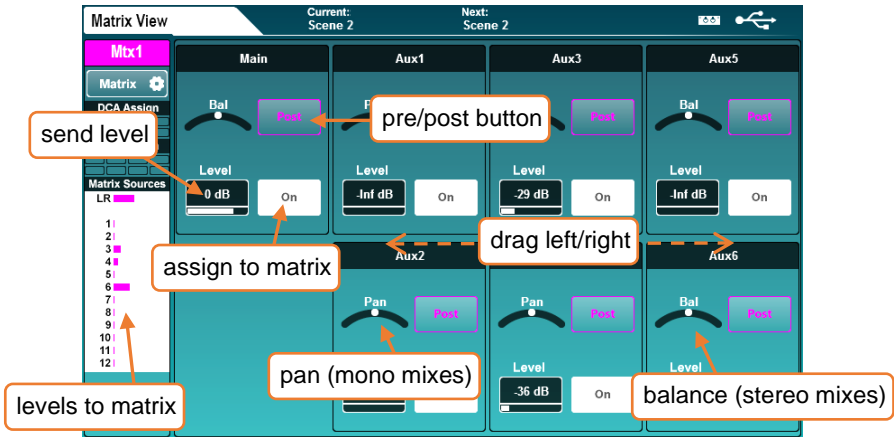

- 3) The matrix sends are shown on faders when a mix channel is selected and the momentary '**CH to All Mix**' key is pressed on the surface of the SQ.

 For information on setting any mix to mono, see [Input/Mix stereo assign](#).

9. Metering

9.1 PAFL LED Meter

The 12 segment LED metering on the surface of the SQ to the right of the touchscreen displays level metering for the PAFL bus.

By default, with no PAFL keys active, this displays the main LR mix level.

- ❗ The PAFL LED indicator below the 12 segment LED illuminates when a PAFL routing key or button is active anywhere in the mixer.

9.2 Input/FX/Output Meters

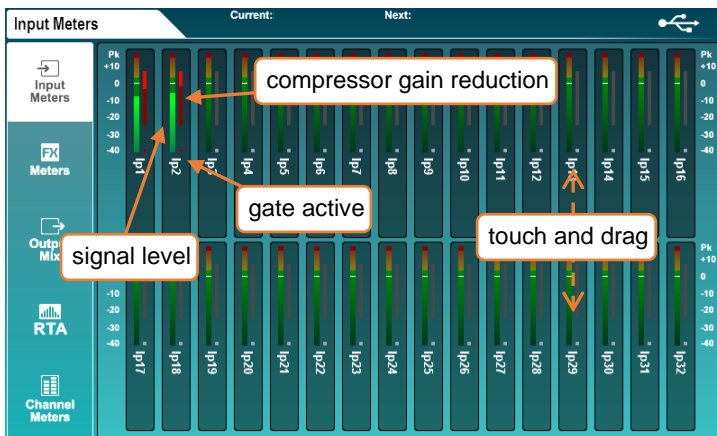

The first three tabs on the **'Meters'** screen show **'Input Meters'**, **'FX Meters'** and **'Output Meters'**.

- The main coloured meter displays levels from -40dB to +10dB.
- The gain reduction meter shows level reduction from 0dB to -30dB, this is red/bright red when the compressor is switched in and grey/white when it is switched out.
- The gate active indicator is red/bright red when the gate is switched in and grey/white when the gate is switched out.
- Touch and drag to view other channels.

- ❗ Input meters display post processing level to show contribution to the mix.

9.3 RTA

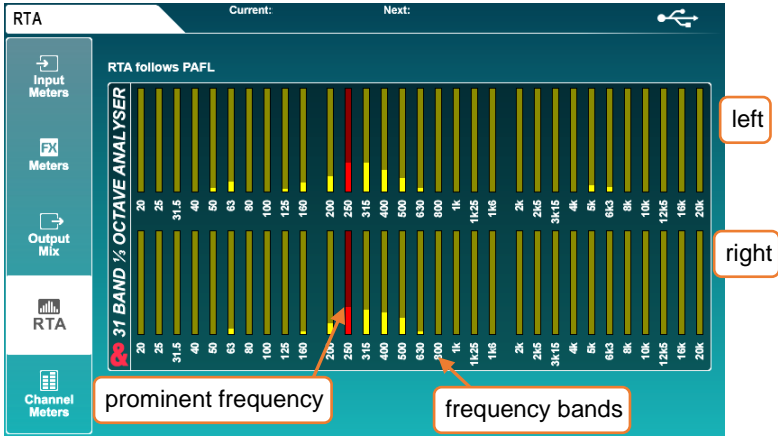

- RTA follows PAFL selection and settings.
- Displays the levels of 31 frequencies with fixed 1/3rd oct bandwidth.
- The meter for the prominent frequency of either left or right is shown in red.

System setup - By connecting a measurement microphone and 'listening' on the PAFL bus, the RTA meters can be used to analyse a room.

Ringing out a room – The RTA can be used to find problem frequencies in channels/groups/mixes. Used in conjunction with PEQ and GEQ, it is easy to reduce the level of frequencies from outputs that may be causing feedback.

i See also [GEQ 'Fader Flip' mode](#), which displays the RTA using channel metering.

9.4 Other Metering

- More detailed metering is also displayed throughout the processing screens and is particularly useful for gain staging with each processing 'block'.
- The peak (Pk) LED's on channels strips use multi-point sensing to display destructive peaking anywhere in the channel/mix processing.
- If a channel is peaking on a channel strip which is on an inactive layer, the layer selection key will illuminate in red.
- SQ-Drive metering displays either the signal being sent to, or the signal returning from the SQ-Drive, depending on its state (recording/playback).

9.5 Chromatic Channel Metering

The Chromatic Channel Metering displays the information of a high-resolution meter in the space of a single LED. It can depict a much greater range of levels than a traditional meter and behaviour is customisable in the **'Channel Meters'** tab.

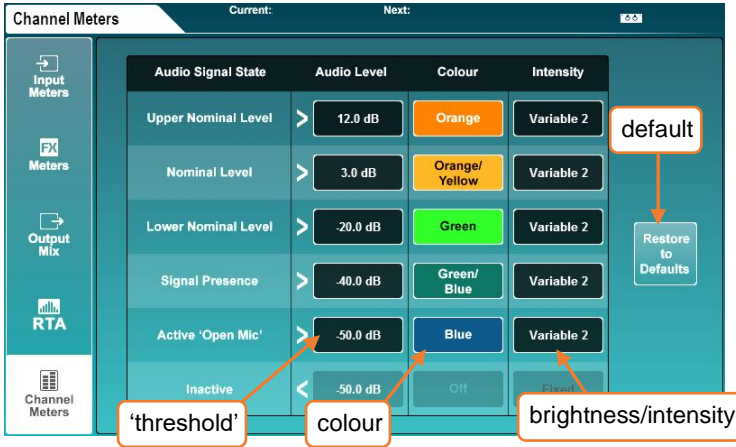

- Touch an **'Audio Level'** value and adjust using the touchscreen rotary.
- **ⓘ** **'Audio Level'** values are bound by the level setting of states above and below.
- Touch a colour for an **'Audio Signal State'** and use the touchscreen rotary to adjust the colour/s for this level range.

Colours = White, Red, Orange, Orange/Yellow, Yellow, Green, Green/Blue, Blue, Blue/Red, Off.

- Touch the **'Intensity'** value to choose the behaviour of the meters.

Fixed = meter switches instantly between states.

Variable 1 = meter changes close to the endpoints of its range.

Variable 2 = meter changes across the whole range.

- Touch the **'Restore to Defaults'** button to restore settings.

Upper Nominal	>	+12.0dB	Orange	Variable 2
Nominal	>	+3.0dB	Orange/Yellow	Variable 2
Lower Nominal	>	-20.0dB	Green	Variable 2
Signal Presence	>	-40.0dB	Green/Blue	Variable 2
Active 'Open Mic'	>	-50.0dB	Blue	Variable 2
Inactive	<	N/A	N/A	N/A

10. FX Engines

10.1 Using FX buses and returns

The SQ has four FX send buses which by default send to the first four FX engine slots (these are preloaded with useful FX presets).

These buses can be used in the same way as any of the mix buses:

- Press an FX key from 1 to 4 to show and adjust the send levels on faders for each fader strip to that FX bus. Or with a channel selected, hold the '**CH to All Mix**' key to show and adjust all FX bus sends for the selected channel (along with all other sends).
- The master FX send level is controlled with the Master channel (when in 'Mix Master' mode and displaying the FX sends on faders).

The FX output signal is returned to the matching FX return channel for each FX engine slot. (i.e. the '**FX Unit 1**' output is routed to '**Fx1Rtn**').

- All FX return channels are stereo and feature PEQ processing.
 - FX Returns can be assigned and sent to mixes in the same way as any input channel.
- ❗ FX return channels can be assigned to fader strips but will not be visible unless they are routed from the output of the FX engine (i.e. set as '**Mix -> Return**' on the back panel).

10.2 Loading units and presets

Pressing the 'FX' screen key displays the front/rear of the currently selected FX engine, with other loaded FX units and empty slots on the left of the screen.



- Select the slot you wish to use.
- Press the 'Library' key on the surface to open the FX Library.
- Select an FX type, then a 'Factory' preset. Different presets use different FX units,
- Touch the 'Recall' button to recall the preset and FX unit.

 User presets can be stored and recalled to and from the 'User' section of the FX library.

10.3 Adjusting parameters

Each FX unit has a different set of parameters, but all work in the same way.

- Touch any buttons to switch between modes or states.
- Touch parameter controls or values and use the touchscreen rotary to adjust.

The SMR unit is a special case - pressing the 'Expert' button will give access to much more in-depth control for fine tuning reverb behaviour. In this mode, cycle through all available parameter settings using the 'Page' button.

10.4 Sending to FX from other sources

Mix->Return - As well as sending using the four FX buses, you can send to the FX engines using mixes, allowing you to send to any of the 8 FX engines using 'sends on faders'. This routing type can also be used with channel direct outs.

For any adjustment to routing first press the '**Back Panel**' button at the top right of the FX screen.

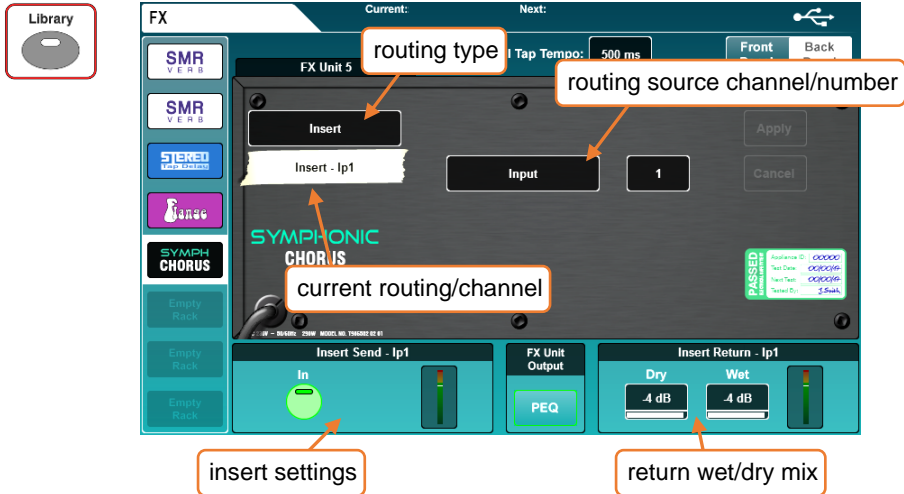

- 1) Set the routing type to '**Mix -> Return**'.
- 2) Touch the routing source value to select a source.

Sources = FX Send, Group, Aux, Main, Matrix, Direct Output

- 3) Touch the channel value and adjust using the touchscreen rotary.
- 4) Touch the '**Apply**' button to apply changes.

Inserts – You can insert FX engines on individual channels or mixes. This automatically sets up and uses the insert point of the channel.

- 1) Set the routing type to '**Insert**'.
- 2) Touch the routing source value to select a source.

Sources = Input, Group, Aux, Main, Matrix

- 3) Touch the channel value and adjust using the touchscreen rotary.
- 4) Touch the '**Apply**' button to apply changes.

ⓘ Typically, signal processors such as multiband compressors and de-essers are inserted in this way.

10.5 FX Levels and PEQ

When routed as **'Mix -> Return'**, the PAFL, Mute and Level settings for the currently selected FX engine slot are displayed at the bottom of the screen for both the FX send and FX return.

- Touch buttons to PAFL or mute channels.
- Touch values and adjust using the touchscreen rotary.

When an FX engine is being used as an insert, the insert **'In'** button and return wet/dry mix values are displayed.

- Touch the **'In'** button to switch the insert in or out.
- Touch either wet or dry values to adjust the blend of the dry (unprocessed) signal with the wet (processed) signal.

Dry/Wet individual level = -infinity to 0dB

Press the PEQ button at the bottom centre of the screen to view and adjust the PEQ which affects the output of the FX. This works in exactly the same way as any channel processing PEQ.

- ⓘ All level and PEQ settings, presented on the FX screen for convenience, duplicate control available elsewhere in the mixer. The PEQ for example, is the same PEQ that can be accessed when selecting FX return channels.

10.6 RackExtra FX Types

Spatial Modelling Reverb (SMR) –

4 fully configurable complex spatial models: Classic, Hall, Room and EMT.



Stereo Tap Delay –

Clean digital delay with link, filters, tap tempo (global or local) and BPM or ms display options.

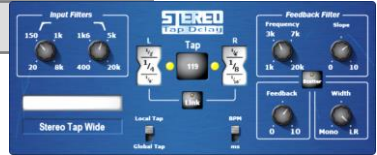

ADT Doubler –

Automatic double tracking unit with double and quad modes, separation, thickness and autopan control.



Chorus –

Versatile chorus unit with 3 stereo field options, rate, depth and LFO control, plus autopan option.



Symphonic Chorus –

A faithful emulation of the 80's classic chorus effect with 2 very simple controls.



Flanger –

3 classic flanger effects in one unit: 'Ambient', 'Vintage' and 'Wild' with multiple LFO and stereo options.



MOO 12 Stage Phaser –

Accurate emulation of a 12 stage phaser, with rich, textured phasing and plenty of control.



Gated Verb –

Emulation of the 80's classic gated reverb, with in-depth control and 2 extra variants: 'Panned' and 'Powerbox'.



RackFX Add-ons

MultiBD Compressor 4 –

Fully featured 4 band compressor for dynamic control on input or mix channels.

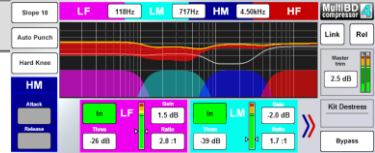

MultiBD Compressor 3 –

Fully featured 3 band compressor for dynamic control on input or mix channels.

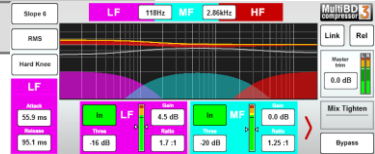

DynEQ4 –

4 band dynamic equaliser, able to carve and shape any sound source.

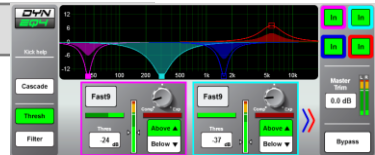

De-Esser –

Classic De-Essing with auto-threshold for natural sibilance reduction.



i Information on how to activate these can be found in the [Add-ons](#) section.

11. Saving and Recalling Shows/Scenes/Libraries

All mix settings in SQ can be stored and recalled in either 'Scenes' or 'Show' files. Scenes are intended for recall during use, whilst a Show file contains everything for an event or particular set up. Show files should also be used to backup a configuration or transfer it to another unit.

Saved in each Scene	Saved in each Show
Input and output routing	300 Scenes
Preamp settings	All Libraries
Channel processing	Stereo Input/Mix and Mix Config
Channel assignments and send levels	Audio Sync settings
Panning and balance	Signal Generator settings
Channel mutes	Talkback settings
Mute Groups and DCA assignments and levels	PAFL settings
Fader strip assignments	Global scene filter settings
FX units and parameters	Channel safes
Channel names	MIDI channel
SoftKey/SoftRotary assignments	USB source
Footswitch settings	Surface brightness preferences
Ganging	Chromatic Channel Metering
	Role/Master Fader Mode

Saved in the SQ
Network settings
Unit name
Fader Calibration
User Permissions

In summary:

- A 'Scene' is a snapshot of all mix settings.
 - There are 300 scene slots available per 'Show'.
 - In addition to all scenes, a 'Show' includes all SQ settings (such as Chromatic Channel Metering and Integrated Surface Illumination settings).
- ❗ The SQ can have one 'Show' on it at any one time. Multiple 'Show' files must be stored or recalled using SQ-Drive or SQ-MixPad.
- ❗ Mixer Config settings including Input Stereo, Mix Stereo and Bus Config require changes to the XCVI core, interrupting audio. It is therefore not possible for these to be changed per scene.

11.1 Scene manager

The scene manager allows scenes to be stored, recalled and deleted.

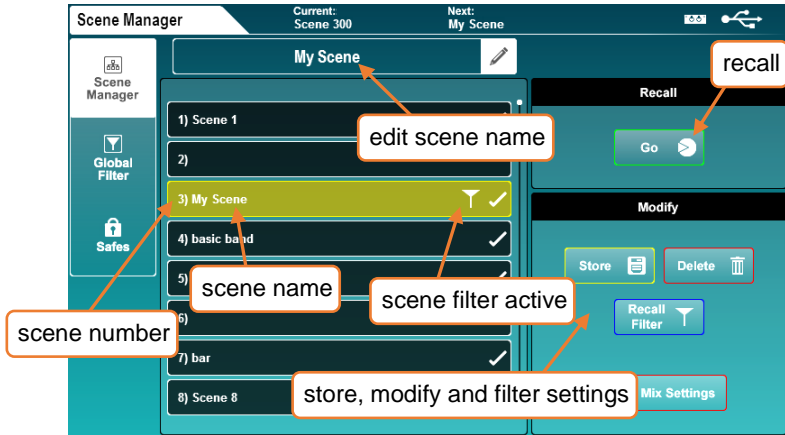

To store all current mix settings in a new slot:

- Touch any empty slot.
- Touch the '**Store**' button to save with the name 'Scene [x]'.
OR
- Touch in the empty scene name field to be prompted to name the scene at the same time as storing it.

To recall a scene:

- Touch a scene to highlight it then touch the '**Go**' button.

To rename a scene:

- Touch the scene, then touch in the edit scene name field at the top of the screen.

To overwrite a scene:

- Touch the scene to overwrite, then touch the '**Store**' button.

To delete a scene:

- Touch the scene you wish to delete then touch the '**Delete**' button.

i You can choose whether or not to confirm scene operations (and avoid accidental overwriting) by using the 'Confirm Scene Operations' button found in [Surface Preferences](#).

To quickly copy, paste or delete scenes:

- Hold the **'Copy'** key and touch the scene you wish to copy.
- Hold the **'Paste'** key and touch the scene slot in which you'd like to paste it.
- Hold the **'Reset'** key and touch a scene to delete it.

Scene Filters

When storing a scene, all mix settings are saved. However, it is possible to filter what is recalled using a combination of scene recall filters and global filters.

i See [Global Filters](#) for information on what each filter does.

To choose which filters are allowed or blocked per scene:

- Touch a scene to highlight it then touch the **'Recall Filter'** button.

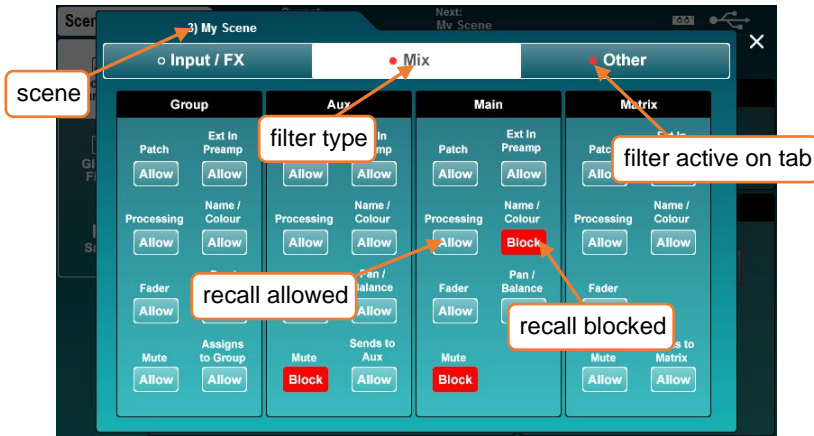

- In the pop-up, there are three tabs 'Input/FX', 'Mix' and 'Other' containing all available filters.
- Touch any filter button to switch between **'Allow'** and **'Block'**.
- Blocked parameters will not be affected when recalling the scene.

i The Copy/Paste/Reset keys can also be used with the 'Recall Filter' button.

Reset Mix Settings

If wanting to start with default mix settings, pressing the **'Reset Mix Settings'** button takes you to the Role page where it is possible to reset the mix without deleting scenes. See [Reset Mix Settings](#) for more information.

11.2 Global Filters

Global scene filters are always active, and affect which settings are changed when recalling a scene. They also override any active scene filters.

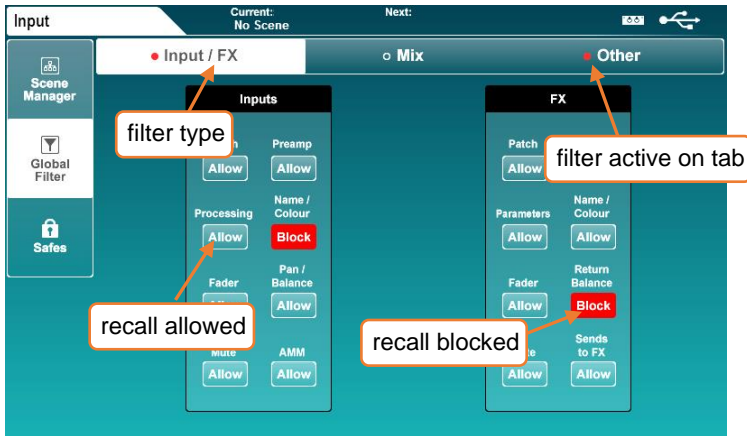

- Touch any filter button to switch between 'Allow' and 'Block'.
- Blocked parameters will not be affected when recalling scenes.

Input/FX Filters

Inputs	
Filter	Includes
Patch	Source and Direct Out patching of input channels
Preamp	Preamp settings of input channels and socket routing (excludes DEEP preamp models)
Processing	All Input channel processing and insert socket settings
Name/Colour	All input channel names and colours
Fader	All input channel fader positions and assignments to the Main LR mix
Pan/Balance	All input channel panning and balance to Main LR mix
Mute	All input channel mutes
AMM	All AMM assignments and settings

FX	
Filter	Includes
Patch	All FX input patching (Mix->Return or Insert) and output patching
Parameters	All FX parameters and wet/dry mix settings
Name/Colour	All FX Send and Return channel names and colours
Fader	All FX Send and Return channel fader positions
Return Balance	All FX Return channel balance positions
Mute	All FX Send and Return channel mutes
Sends to FX	All send levels and assignments to FX busses

Mix Filters

Group	
Filter	Includes
Patch	Mix Ext In source plus output patching of Group channels
Ext In Preamp	Preamp settings of Group Mix Ext In
Processing	All Group channel processing
Name/Colour	All Group channel names and colours
Fader	Master fader positions and output balance of Group channels
Pan/Balance	Master pan and balance positions for all Group channels
Mute	Master mute for all Group channels
Assigns to Group	All channel assignments to all groups

Aux	
Filter	Includes
Patch	Mix Ext In source plus output patching of Aux channels
Ext In Preamp	Preamp settings of Aux Mix Ext In
Processing	All Aux channel processing
Name/Colour	All Aux channel names and colours
Fader	Master fader positions and output balance of Aux channels
Mute	Master mute for all Aux channels
Sends to Aux	All send levels to Aux channels

Main	
Filter	Includes
Patch	Mix Ext In source plus output patching of the Main LR channel
Ext In Preamp	Preamp settings of Main LR Mix Ext In
Processing	Main LR channel processing
Name/Colour	Main LR channel name and colour
Fader	Master fader positions and output balance of the Main LR channel
Mute	Master mute for all Main LR channel

Matrix	
Filter	Includes
Patch	Mix Ext In source plus output patching of Matrix channels
Ext In Preamp	Preamp settings of Matrix Mix Ext In
Processing	All Matrix channel processing
Name/Colour	All Matrix channel names and colours
Fader	Master fader positions and output balance of Matrix channels
Mute	Master mute for all Matrix channels
Sends to Matrix	All send levels to Matrix channels

Other Filters

DCA/Mute Group	
Filter	Includes
Assign	All assignments to DCA and Mute Groups
Master	DCA and Mute Group state, including mutes, fader, name and colour

Input Sockets	
Filter	Includes
Tie Line Only Preamps	Preamp parameters for connected sockets not assigned to a channel

Output Sockets	
Filter	Includes
Local Patch	All patching to local output sockets (XLR, TRS and AES)
SLink Patch	All patching to the SLink port
USB Patch	All patching to USB (SQ-Drive and USB-B)
ME Patch	All patching to the ME system (SLink or I/O Port)
I/O Port Patch	All patching to the I/O Port

Control	
Filter	Includes
SoftKeys	All SoftKey assignments
Strip Assign	Channel strip layout
Soft Rotaries	All Soft Rotary assignments
Ganging	All ganging assignments and linked parameters
Footswitches	Footswitch assignments

- ❗ It is common to block **'SoftKeys'** and **'SoftRotaries'**, so they continue to function in the same way whenever scenes are recalled.
- ❗ Changes to Talkback and PAFL Ext In patching and preamp parameters are always blocked as these are show level parameters.
- ❗ All output socket filters also affect socket settings e.g. AES sample rate setting.

11.3 Safes

'Safes' block any changes to a channel when recalling a scene.

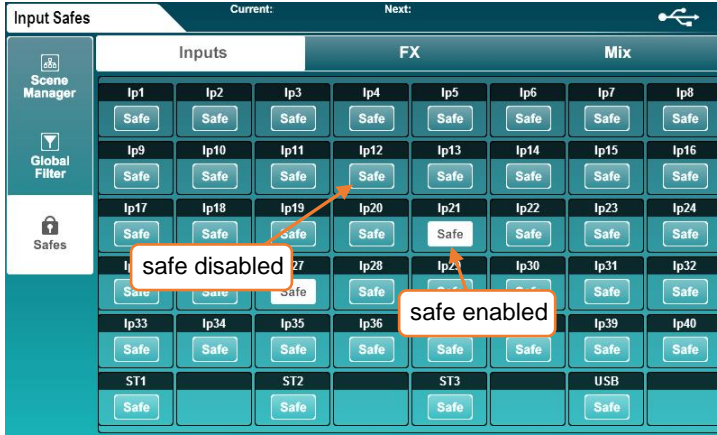

- Touch 'Input', 'FX' or 'Mix' tabs to view all channel safes.
- Touch a 'Safe' button to safe the channel (the button will turn white).

11.4 Libraries

Factory Libraries and User Libraries are available for many features and processing in SQ and can be accessed by using the dedicated Library key when in certain screens.



Throughout this document, where a library is available for use, it is noted with an image of the library key next to the screen image.

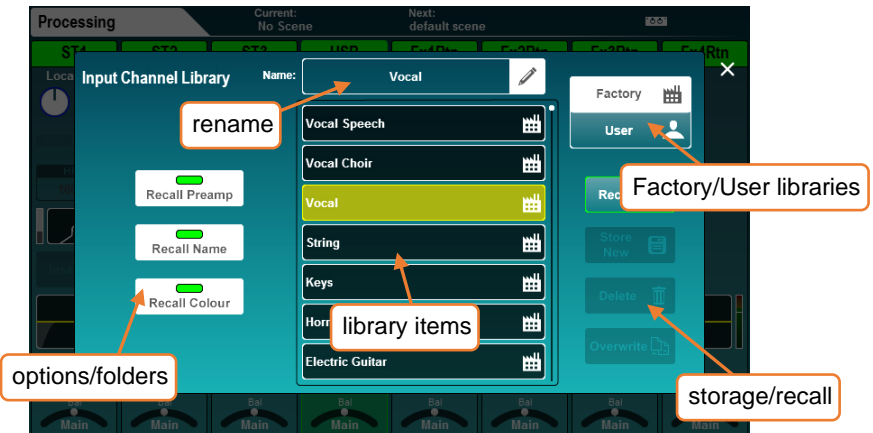

Factory libraries provide presets and are also used to recall different FX units or DEEP plug-ins. They are fixed in firmware and cannot be edited or overwritten.

To recall from the library:

- Go to the screen you wish to recall parameters for.
- Press the '**Library**' key.
- Select the Factory or User library item you wish to recall.
- Touch the '**Recall**' button.

To store or overwrite a library item:

- Go to the screen you wish to store parameters for with the settings you wish to store visible.
- Press the '**Library**' key.
- Select the User library in the top right of the screen.
- Touch the '**Store New**' button to store a new library item.

OR

- Select a library item and touch the '**Overwrite**' button.

To delete a library item:

- Select the User library in the top right of the screen.
- Select the library item you wish to delete.
- Touch the '**Delete**' button then confirm to delete the item.

Libraries are available in the following screens.

SQ Libraries		
Library	Screen	Includes
Input Channel	Processing overview (input selected)	All input channel processing - Options for Preamp, Name and Colour recall
Mix Channel	Processing overview (mix selected)	All mix channel processing - Options for Ext In Preamp, Name and Colour recall
Preamp Model	Processing > Preamp (input selected)	DEEP preamp model and parameters
Gate	Processing > Gate	Gate parameters
GEQ	Processing > GEQ	DEEP GEQ models and parameters
PEQ	Processing > PEQ	PEQ parameters - Option for HPF
Compressor	Processing > Compressor	DEEP compressor models and parameters
FX	FX (rack selected)	FX units and parameters, including Wet/Dry mix
User Permissions	Setup > Users (User 1- 10 selected)	User permission settings
Input Channel Patch	I/O > Inputs	All patching for Input Channel and Mix Ext In

11.5 Data transfer (USB/MixPad)

All data transfer options are located in the **'Utility'** screen, in the **'Data'** tab. These enable shows and individual scenes and libraries to be stored and recalled, and are used to back-up data or transfer it to another SQ.

USB Shows

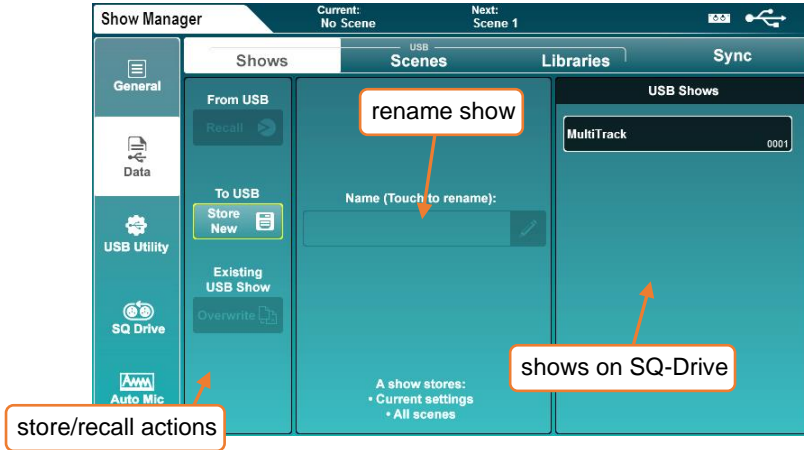

To store a show to a USB device:

- Touch the **'Store New'** button - you will be prompted to name the show.

To recall a show:

- Touch a show to highlight it (use the touchscreen rotary to change selection or scroll through all shows) then touch the **'Recall'** button.

To rename a scene:

- Touch a show, then touch in the **'Name'** field in the centre of the screen.

To overwrite a scene:

- Touch the scene to overwrite, then touch the **'Overwrite'** button.

❗ Storing or recalling shows is not possible when SQ-Drive is being used for recording or playback.

❗ Storing or recalling shows will interrupt USB-B streaming.

USB Scenes



To store a scene to a USB device:

- Touch to select the scene you wish to store in the '**SQ Scenes**' list on the left.
- Touch the '**To USB**' button.

To transfer a scene from USB to the SQ:

- Touch to select the scene to transfer in the '**USB Scenes**' list on the right.
- Touch to select an empty slot in the '**SQ Scenes**' list on the left.
- Touch the '**To SQ**' button to transfer.

To overwrite a scene:

- Touch to select the scene to transfer in the '**USB Scenes**' list on the right.
- Touch to select the scene to overwrite in the '**SQ Scenes**' list on the left.
- Touch the '**Overwrite SQ**' button to transfer and overwrite the SQ scene.

To delete a scene from USB:

- Touch to select the scene to delete in the '**USB Scenes**' list on the right.
- Touch the '**Delete**' button and confirm the action in the pop-up.

USB Libraries



To store a library item to a USB device:

- Touch to select the library item you wish to store in the '**SQ Libraries**' list on the left.
-  All user libraries in the current show are displayed.

- Touch the '**To USB**' button.

To transfer a library item from USB to the SQ:

- Touch to select the library to transfer in the '**USB Libraries**' list on the right.
- Touch the '**To SQ**' button to transfer.

To overwrite a library item:

- Touch to select the library item to transfer in the '**USB Libraries**' list on the right.
- Touch to select the library item to overwrite in the '**SQ Libraries**' list on the left.
- Touch the '**Overwrite SQ**' button to transfer and overwrite the SQ library item.

To delete a library item from USB:

- Touch to select the library item to delete in the '**USB Libraries**' list on the right.

Touch the '**Delete**' button and confirm the action in the pop-up.

Sync

To push or pull data using the SQ-MixPad app, the SQ console must be in sync mode. This avoids accidental overwriting of data on both the SQ console and SQ-MixPad.

To enter sync mode, go to the 'Utility' screen, then touch 'Data' followed by 'Sync'.

Touch the '**Sync Mode**' button then confirm you understand the implications of sync mode in the pop-up to proceed.

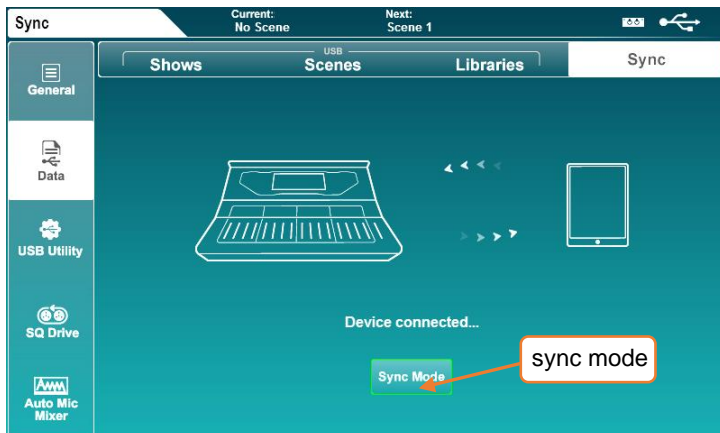

Once in sync mode, pushing and pulling of data is controlled by SQ-MixPad.

- ❗ Refer to SQ-MixPad help for more information on data transfer to and from MixPad.
- ❗ Starting sync mode will disconnect all devices aside from the one being connected to as all network bandwidth is required without interruption.

12. Setup

12.1 Strip assign

All fader strips on the SQ are freely assignable.

Press the **'Setup'** screen key, touch the **'Surface'** tab then touch the **'Strip Assign'** tab.



- SQ channels are displayed in the top half of the screen. Select channel types by touching buttons on the right, and touch and drag left or right to view all available channels.
 - Fader strips are displayed in the bottom half of the screen. Select layers by touching the buttons to the right or switching layers on the surface, then touch and drag left or right to view all available fader strip slots.
 - To assign channels to fader strips, touch and drag them from the top row to a fader strip in the bottom row.
 - To remove assignments, touch and drag them out of the fader strip at the bottom towards the top of the screen.
- ❗ FX return channels can be assigned to fader strips, but will not be visible unless they are routed from the output of the FX engine (i.e. set as **'Mix -> Return'** on the back panel).
- ❗ The 'Listen' bus is not a channel type, but the Master fader can be used to control Listen Level. See the [Mixer Role](#) section for more information.

12.2 Input/Mix stereo assign

To use channels as stereo channels throughout the mixer, they must first be switched into stereo mode.

In the 'Setup' screen, touch the 'Mixer Config' tab, then touch either 'Input Stereo' or 'Mix Stereo'.

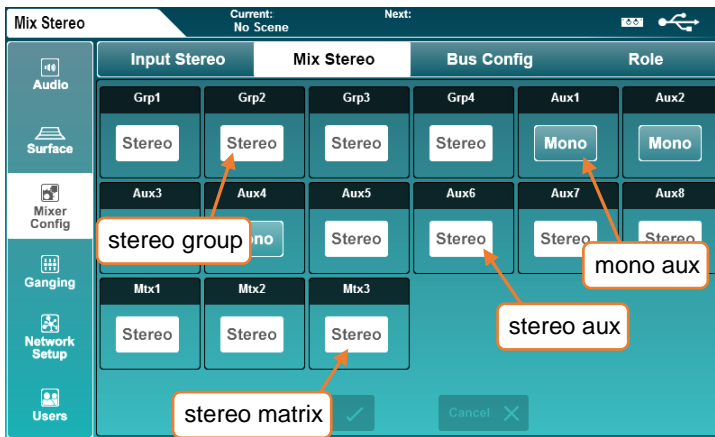
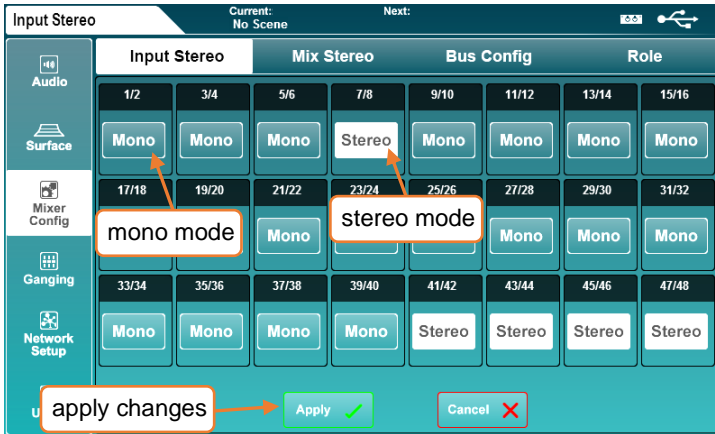

- Odd/even pairs of input channels or any mix can be switched between mono and stereo mode by touching the 'Mono/Stereo' button.
- Touch the 'Apply' button to apply any changes.
- Touch the 'Cancel' button to undo changes and display the current state.

12.3 Mix bus configuration

The 12 mixes can be switched between group and auxiliary modes under the 'Bus Config' tab.

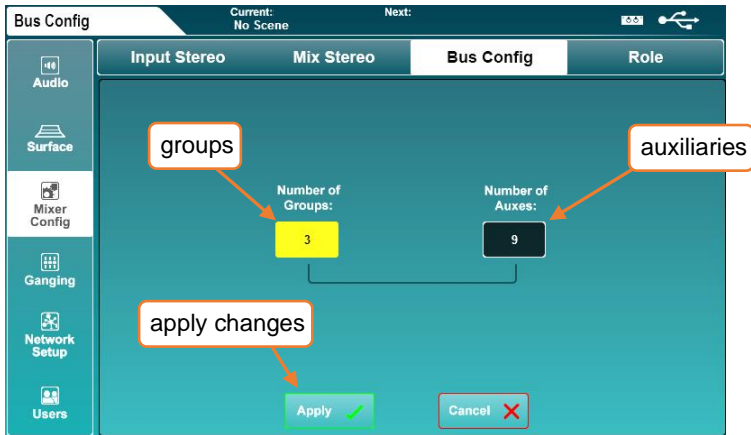

- Touch either the 'Number of Groups' value or the 'Number of Auxes' value, then adjust using the touchscreen rotary.
- Increasing the number of groups will decrease the number of auxiliaries and vice versa.
- Touch the 'Apply' button to apply any changes.

Auxiliaries will always be assigned sequentially to the first mix keys, with groups assigned afterwards. For example, if you configure the buses as 5 groups and 7 auxes, auxes 1 to 7 will be on mix keys 1 to 7 and groups 1 to 5 will be on mix keys 8 to 12.

- ❗ Mix keys assigned to auxes illuminate blue when active, and mix keys assigned to groups illuminate magenta.

12.4 SoftKeys/SoftRotaries

SoftKeys and SoftRotaries (SQ-6) allow you to customise surface controls of the SQ.

Press the **'Setup'** screen key, then touch the **'Surface'** tab followed by the **'Soft Controls'** tab to view and adjust SoftKey and SoftRotary assignments.

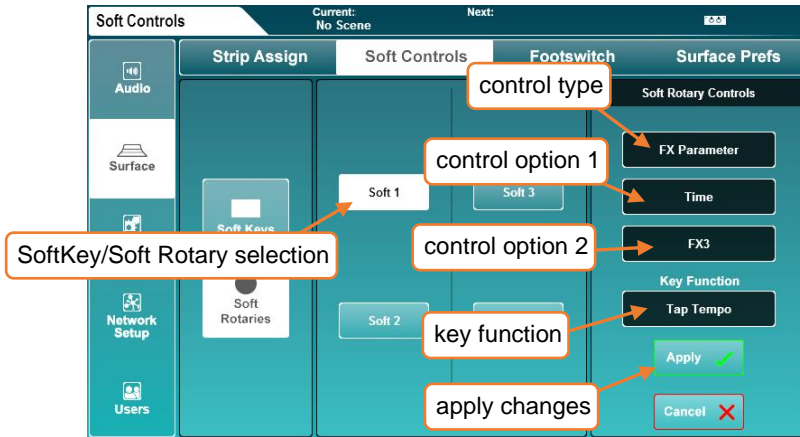

To change the function of a SoftKey or SoftRotary:

- 1) Touch either **'Soft Keys'** or **'Soft Rotaries'** (SQ-6, SQ-7).
- 2) Touch a numbered SoftKey or SoftRotary button, these match the labelling on the surface of the SQ and turn white when selected.
- 3) Touch the control type value and select a type.
- 4) Touch the control option 1 value (when available) and select an option.
- 5) Touch the control option 2 value and select an option.
- 6) For Soft Rotaries on SQ-6 and SQ-7 there is a third control option, to select the function of the associated key.
- 7) Touch the **'Apply'** or **'Cancel'** button, to apply or disregard any changes.

SoftKeys illuminate with different colours depending on function. When assigned to a Tap Tempo, they flash to display the current tempo.

Each SoftRotary has an LCD display, an assignable key and is illuminated when active, with the colour of the rotary and key relating to the assigned function.

- The SoftRotary LCD display momentarily displays parameter value when adjusted.
- Press the 'View' key multiple times to display Soft Rotary function and value.

Possible SoftKey assignments			
Control Type	Control Option 1	Control Option 2	Colour
Unassigned	N/A	N/A	N/A
Channel Mute	N/A	All audio channels	Red
Mute Group	N/A	Mute Groups 1 to 8	Red
DCA Mute	N/A	DCA's 1 to 8	Red
Tap Tempo	Left, Right, Left & Right	FX engines 1 to 8	Red
Global Tap Tempo	N/A	N/A	Red
Recall Scene	N/A	All saved scenes	Red
Scene Store Current	N/A	N/A	Red
Scene Recall Go	None, Auto Increment	N/A	Red
Scene Next	N/A	N/A	Red
Scene Previous	N/A	N/A	Red
Channel PAFL	N/A	All audio channels	Yellow
DCA PAFL	N/A	DCA's 1 to 8	Yellow
PAFL Clear	N/A	N/A	Red
SQ-Drive Stereo Play	N/A	Previous, Stop, Start/Pause, Next	N/A
SQ-Drive Stereo Record	N/A	Stop, Start/Pause, Arm	N/A
SQ-Drive Multitrack	N/A	Stop, Start/Pause, Arm	N/A
MMC	N/A	Rewind, Play, Pause, Stop, FFwd, Record	N/A
DAW Control	N/A	Bank Up, Bank Down	N/A
Talk	N/A	N/A	Green
Mix Select	N/A	All mixes	Blue/Magenta
AMM In/Out	N/A	AMM 1, AMM 2	Green
AMM Channel On/Off	N/A	All input channels	Green
MIDI note On/Off	MIDI Channel	Note	Red
MIDI Program change	MIDI Channel	Program 0 - 127	Red

Possible SoftRotary assignments			
Control Type	Control Option 1	Control Option 2	Key
Unassigned	N/A	N/A	N/A
Main Level Fader	Current Selection, all main send levels	N/A	Unassigned, Mute, PAFL
DCA Level Fader	DCA's 1 to 8	N/A	Unassigned, Mute, PAFL
Send Level Fader	Current Selection, all input and mix channels	Main LR, all aux and FX sends	Unassigned, Assign (to mix)
Pan	Current Selection, all input and mix channels	Main LR, all stereo aux	Unassigned, Centre
Gate	Threshold, Depth, Attack, Hold, Release	Current Selection, all input channels	Unassigned, In
Compressor	Threshold, Ratio, Gain, Attack, Release	Current Selection, all input and mix channels	Unassigned, In
Preamp	Gain, Trim	Current Selection, all input and mix channels	Unassigned, Pad, Polarity
HPF Frequency	Current Selection, all input channels	N/A	Unassigned, In
PEQ Band	LF, LM, HM, HF	Current Selection, all input and mix channels	Gain/Width/Freq
AMM Priority	All input channels	N/A	Unassigned, On
Preamp model	Fine Adjustment, Level	Current Selection, all input channels	Unassigned, In
MIDI absolute	MIDI Channel	CC#	Unassigned, Note
MIDI relative	MIDI Channel	CC#	Unassigned, Note
FX Parameter	Time, Amount*	Rack FX Slot (1-8)	Tap Tempo
MIDI Program Change	MIDI Channel	N/A	Sends MIDI
PAFL Listen Level	N/A	N/A	N/A

*FX Parameter 'Time' and 'Amount' functions for different FX units

FX Unit	Time	Amount
SMR Reverb	Decay Time	N/A
Gated Verb	N/A	N/A
Stereo Tap Delay	Delay Time	Feedback Amount
ADT	Delay Separation	Thickness
Blue Chorus	Rate	Depth
Symphonic Chorus	Frequency	Depth
Flanger	Speed	Depth
Phaser	Rate	Depth

12.5 Footswitch

Connecting a single or dual, momentary or latching footswitch with a TS or TRS ¼" jack plug to the **'Footswitch'** socket allows hands-free control of the SQ.

In the **'Setup'** screen, touch the **'Surface'** tab then the **'Footswitch'** tab to display and adjust the footswitch settings and assignments.

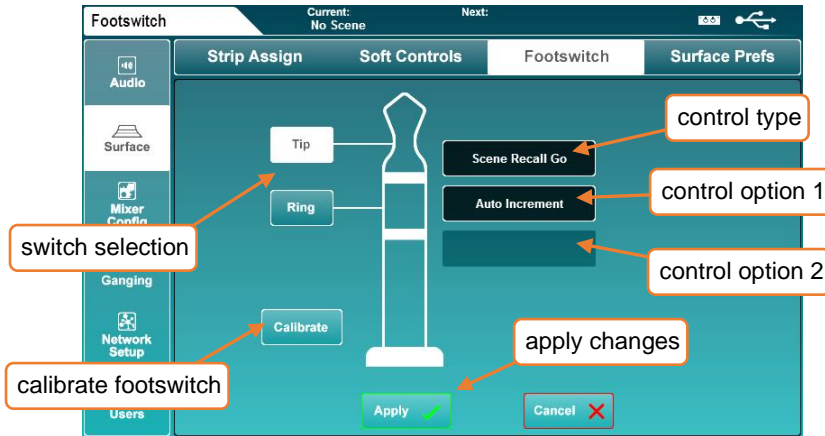

When first connecting a footswitch, touch the **'Calibrate'** button to set the type of switch being used. Follow the on-screen instructions.

- Single footswitches usually use only the **'Tip'** connection.
- You may need to experiment to find which switch is connected to tip or ring with a dual footswitch.

Options for the type of switch are as follows and must match the footswitch hardware:

Unused = Select for a switch you do not wish to use.

Latching = Press and release to switch on, press again to switch off.

Momentary = Press and hold to switch on, release to switch off.

Soft Latch = Enables a momentary switch to be used as a latching switch.

To assign a function to a footswitch:

- 1) Touch either **'Tip'** or **'Ring'** buttons to select a switch.
- 2) Touch the control type value and select a type.
- 3) Touch the control option 1 value (where available) and select an option.
- 4) Touch the control option 2 value (where available) and select an option.
- 5) Touch the **'Apply'** or **'Cancel'** button, to apply or disregard any changes.

i Available footswitch assignments match those for SoftKeys.

12.6 Surface Preferences

Press the **'Setup'** key, then touch the **'Surface'** tab followed by the **'Surface Prefs'** tab to see the surface preferences.

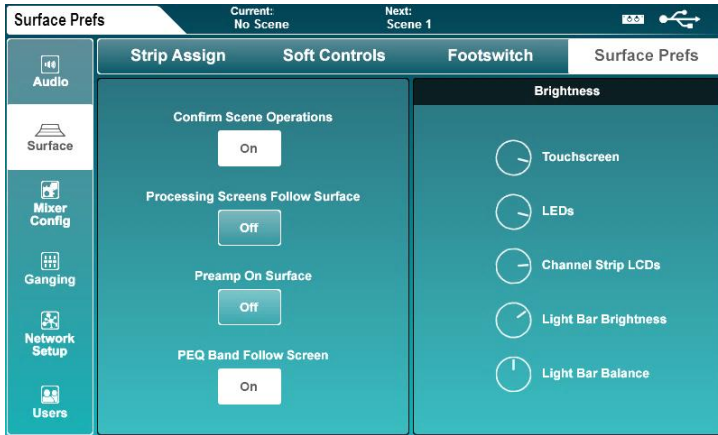

i This screen can also be accessed by pressing the **'Brightness'** button on the **'Home'** page.

- Touch the **'Confirm Scene Operations'** button to enable or disable confirmation pop-ups when performing scene overwriting/recalling/deleting operations.
- Touch the **'Processing Screens Follow Surface'** button to enable or disable the option for processing screens to change to the last adjusted parameter.
- Touch the **'Preamp On Surface'** button to choose whether the dedicated surface preamp control can adjust gain on preamps or only trim.
- Touch the **'PEQ Band Follow Screen'** button to choose whether the band selection on the surface follows the on-screen PEQ band selection.

i The 'Preamp on surface' setting is useful when there is a digital split between two consoles and gain adjustments would affect both. Instead, it allows quick adjustment of trim, which is local to the console.

Brightness

These settings individually control the brightness of illumination across the SQ.

- Touch a parameter dial and adjust using the touchscreen rotary.

Touchscreen = The touchscreen backlight

LED's = All surface LED's including keys, channel and PAFL metering

Channel Strip LCDs = Channel naming strip LCD backlights

Light Bar Brightness = Brightness of the integrated illumination

Light Bar Balance = Colour of the integrated illumination

12.7 PAFL

The Pre/After Fade Listen settings affect the behaviour of the PAFL bus which is routed to the SQ headphone output and displayed on the 12 segment LED meter as well as being routed to the SQ's [RTA](#).

Press the '**Setup**' screen key, then touch the '**Audio**' tab, followed by the '**PAFL**' tab to display and adjust settings.

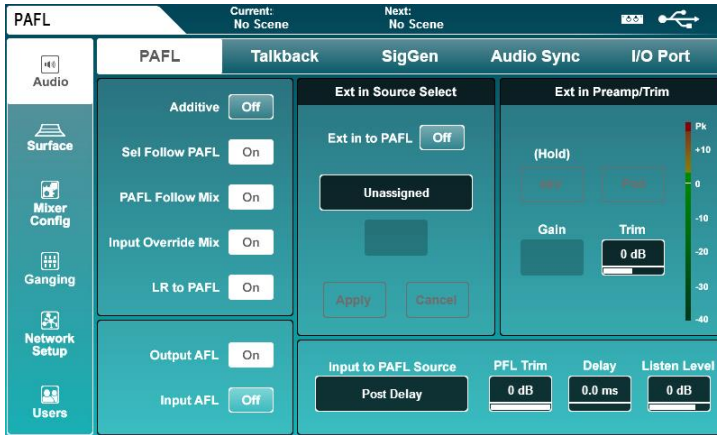

- Touch any button on the left of the screen to turn an option on or off.

Additive (On) = Allows multiple channel strips to be routed to the PAFL bus at once.

Sel Follow PAFL (On) = Pressing a PAFL key will also select ('**Sel**') a channel.
PAFL Follow Mix (On) = When PAFL is active on the master/mix channel strip, the channel being routed to PAFL will follow mix selection.

Input Override Mix (On) = When PAFL is in additive mode, pressing the PAFL key of an input channel unassigns mix channels from the PAFL bus.

Unassigning all input channels reassigns the previously assigned mixes.

LR to PAFL (On) = When no other PAFL routing is active, the main LR mix is routed to the PAFL bus.

Output AFL (Off) = Output channels routed to the PAFL bus are pre-fade.
(Pre-Fade Listen)

Output AFL (On) = Output channels routed to the PAFL bus are post-fade.
(Post/After Fade Listen)

Input AFL (Off) = Output channels routed to the PAFL bus are pre-fade.
(Pre-Fade Listen)

Input AFL (On) = Input channels routed to the PAFL bus are post-fade.
(Post/After Fade Listen)

Ext in Source Select and Ext in Preamp/Trim –

Use these settings to select an external in socket to feed directly to the PAFL bus. Preamp control will become available when a local or remote preamp has been assigned.

Use the 'Ext in to PAFL' button to switch the external in signal on or off.

- ⓘ This feature is intended for communication between two systems, so it is active even when the PAFL bus is being used to monitor channels.

Input to PAFL Source Point –

Select where in the channel the PAFL signal is sourced from.

Post Preamp = Signal is affected by preamp only
Post Insert Return = Also includes DEEP Preamp, HPF, Gate and Insert
Post PEQ = Also includes PEQ
Post Delay = Also includes Compressor and Channel Delay

- ⓘ Note that 'Post Preamp' setting does not include DEEP Preamp processing.

PFL Trim -

The PFL trim attenuates the level of PFL signal routed to the PAFL bus. It does not affect AFL.

PFL Trim = -24dB to 0dB

Delay -

The PAFL delay can be used to align the PAFL bus when, in a live sound environment, the naturally delayed sound from a sound system can be heard at the same time as the otherwise instant signal fed to headphones or monitors, causing phase issues or an audible delay.

PAFL bus delay = 0ms to 682.6ms

Listen Level -

The Listen bus is fed by the PAFL signal and can be patched to an output socket. The Listen Level affects the output level of this bus.

Listen Level = -Inf to +10dB

- ⓘ The Listen Level can also be controlled by the master fader. See the [Mixer Role](#) section of this guide for more information.

12.8 Talkback settings

Talkback is used to enable the engineer to communicate via the audio outputs.

When the **'Talk'** key is pressed, the talkback source is routed to all assigned mixes.

Press the **'Setup'** screen key, then touch the **'Audio'** tab followed by the **'Talkback'** tab to view and adjust the talkback settings.

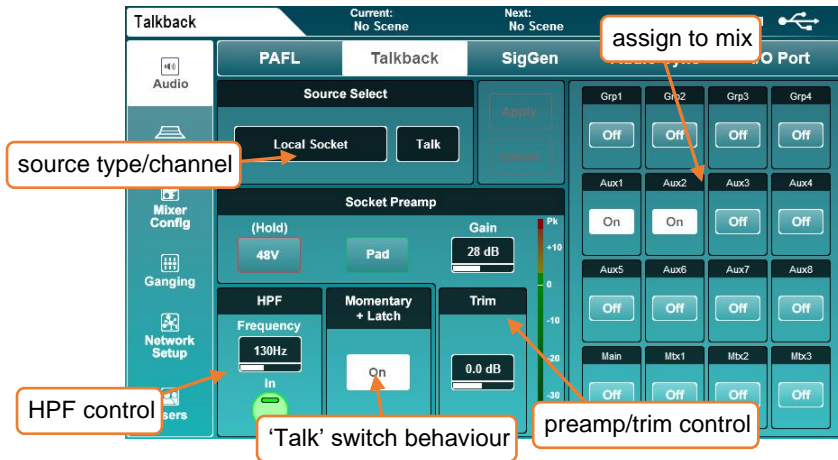

- Source, preamp and trim settings are the same as those used in the Processing/Preamp screen, and can be adjusted in exactly the same way.
- Similarly, HPF works in the same way as for any input channel in the Processing/HPF and PEQ screen.
- Touch the momentary latch **'On'** button to enable the **'Talk'** key latching mode. When this mode is on, a quick single press of the **'Talk'** key switches talkback on or off, though the key will continue to work as in momentary mode if held.
- Touch any mix assign button to switch the talkback feed on or off for that mix.

i Note that the local **'Talk'** socket can be used as an extra input channel socket. When **'Talk'** is assigned to an input channel, changing preamp settings in the Processing screen for that channel will also change settings in the Talkback setup and vice versa. The same logic applies when a source other than the local **'Talk'** socket is assigned as the Talkback source. The HPF and Trim however, are independent.

12.9 Signal Generator

The signal generator can be used to send a signal to a mix for level configuration or used in conjunction with the [RTA](#) and a measurement microphone to check the frequency response of a system.

Press the **'Setup'** screen key, then touch the **'Audio'** tab followed by the **'SigGen'** tab to view and adjust the signal generator settings.

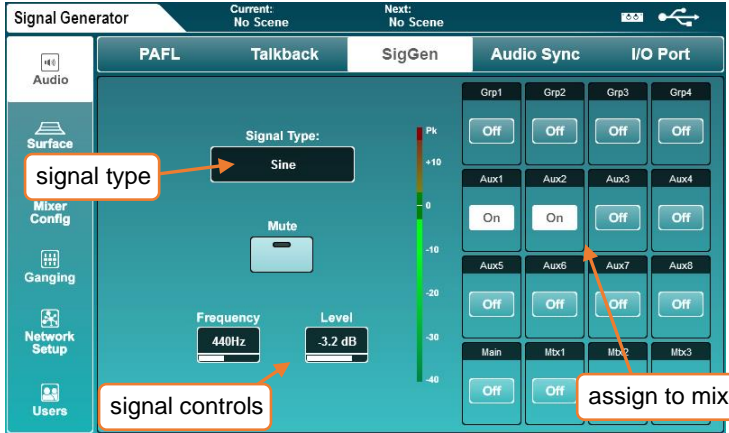

- Touch the **'Signal Type'** value to select a type of signal.

Signal Type = Sine, White noise, Pink noise, Band-pass noise

- Touch the **'Mute'** button to mute or unmute the signal.
- Touch the **'Frequency'** value (where available) and use the touchscreen rotary to adjust.

Frequency = 20Hz to 20kHz

- Touch the **'Level'** value and use the touchscreen rotary to adjust.

Level = -72dB to +18dB

- Touch any mix assign button to assign or unassign the signal generator to or from a mix.

- **i** The signal generator can also be used by any input channel. Select **'Signal Generator'** in **'Source Select'** on the Processing/[Preamp](#) screen.

12.10 Audio Sync and AES sample rate

Press the **'Setup'** screen key, then touch the **'Audio'** tab followed by the **'Audio Sync Opts'** tab to see clock source and AES digital output sample rate options.

Audio Clock Source -

- Touch the **'Audio Clock Source'** value to select a source.

Internal = Sync to the internal audio clock.

SLink = Sync to a digital clock signal being received by the SLink port.

I/O Port = Sync to a digital clock signal being received on the port of a connected option card.

- Touch the **'Apply'** button to apply changes.

When successfully synchronised, a green tick will be shown to the right of the source selection. When there is no suitable clock being received, a red cross is shown to the right of the source selection and in the SQ title bar.

- Using the SQ as a standalone system with or without expansion units, **'Internal'** should be selected as the clock source.
 - With a direct SQ to SQ connection, one console can be thought of as the master and the other a slave. The master console can clock to anything except for the port the slave is connected to, and the slave must clock to the port connected to the master.
 - If connecting directly to a Qu, the port the Qu is connected to must be used as the clock source.
 - When connecting to another system or 3rd party audio network (such as Dante or Waves), one master clock source on the network should be determined and all other units should synchronise to it.
- i** The SQ will always run at 96kHz internally, even if the clock source it is synchronised to is running at 48kHz.

- i** Issues with clocking can result in audible clicks and pops in the audio.

AES Out -

The sample rate of the digital AES output can be changed if required.

- Touch the current sample rate value, then select an option.

AES Output Sample Rate = 44.1kHz, 48kHz, 88.2kHz, 96kHz

- Touch the **'Apply'** button to apply any changes.

There are multiple option cards available for the SQ's I/O Port.

These allow the SQ to interface with 3rd party audio networking protocols, as well as providing the option to add a second SLink port.

Press the **'Setup'** screen key, then touch the **'Audio'** tab followed by the **'I/O Port'** tab.

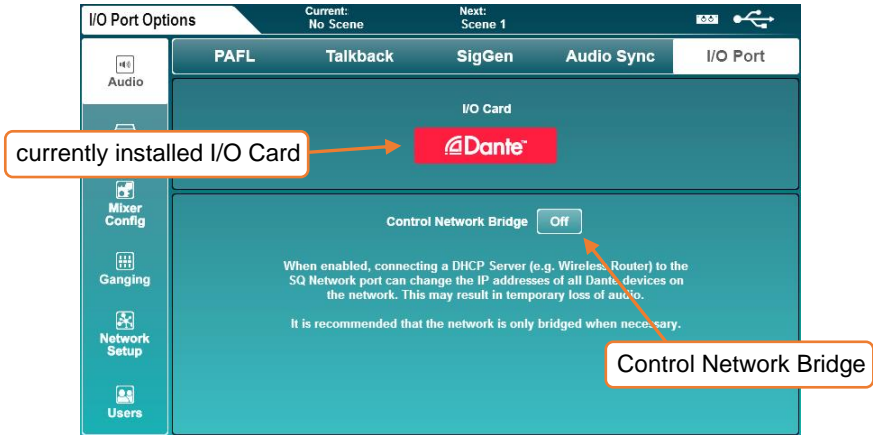

This screen shows which option card is currently connected. It also contains the **'Control Network Bridge'** switch.

When the Control Network Bridge is on, the option card is internally connected (bridged) to the SQ's Network port. This allows a computer on the same network as the SQ itself to 'see' and adjust settings for the fitted option card.

Note that having the Control Network Bridge **'On'** can cause issues with certain setups. Details of these potential issues are shown in the bottom half of the screen and should be considered before the network is bridged.

12.12 Mixer Role and Master Fader Mode

For quick setup from a known starting point you can select the 'role' of the SQ.

Press the **'Setup'** screen key, then touch the **'Mixer Config'** tab followed by the **'Role'** tab to view options for resetting mix settings and to change the master fader mode.

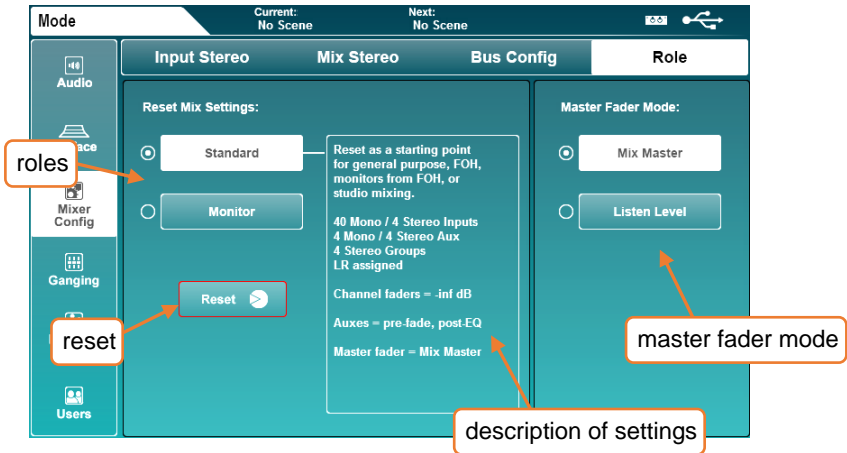

Reset Mix Settings -

Selecting a role for the SQ and touching the **'Reset'** button will reset the mix. Scenes and libraries are unaffected, though global filters and safes (used when recalling scenes) are ignored, and all safes are cleared.

i For details on default settings for different roles, see the [Mix/System Reset](#) section.

Master Fader Mode -

The master fader can either be used to control the master send level of the selected mix or the level of the listen bus. Touch either mode button to instantly switch mode.

i The listen level can be viewed and adjusted in the [PAFL](#) screen.



In **'Mix Master'** mode, the blue LR mix key on the surface is illuminated blue when the LR mix is selected.



In **'Listen Level'** mode, the blue LR mix key on the surface is illuminated red at all times.

12.13 Input Ganging

Ganging enables attributes to be linked across multiple input channels. This means changes to linked attributes on one member of the gang affect all other members of that gang at the same time.

The SQ features 8 gangs with up to 12 members in each.

To setup ganging, press the **'Setup'** screen key, then touch the **'Ganging'** tab.

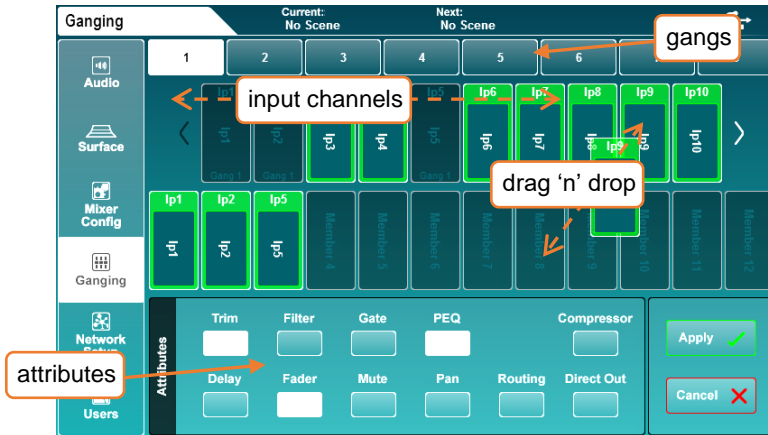

- Select a gang using the numbers at the top of the screen.
- Drag and drop input channels from the channel list to the gang. Touch and drag left and right to see all available channels.
- Touch attribute buttons to switch linked attributes for the selected gang on or off. Linked attributes are indicated with white buttons.
- Touch the apply button to create the gang.

Attributes that can be linked by a gang are as follows:

Trim = Post preamp trim
Filter = HPF in/out and frequency
Gate = All gate parameters
PEQ = All PEQ parameters
Compressor = All compressor parameters
Delay = Channel ms delay
Fader = Input fader master position (i.e. to Main LR)
Mute = Channel mute state
Pan = Channel Pan/Balance to mix
Routing = Assignments and send levels to mix
Direct Out = Direct out level

12.14 Network Setup

For use with any control over Ethernet, such as wireless control or use with MIDI over TCP/IP, the SQ must be connected as a device on a network.

With default settings, the SQ will automatically connect to any network which uses DHCP to assign IP addresses, and will be seen by any apps running on devices connected to the same network.

In some situations, it is necessary or preferable to use a static IP address. It is not recommended to use the static settings unless you fully understand the network you are connecting to.

Press the **'Setup'** screen key, then touch the **'Network Setup'** tab to view and adjust network settings.

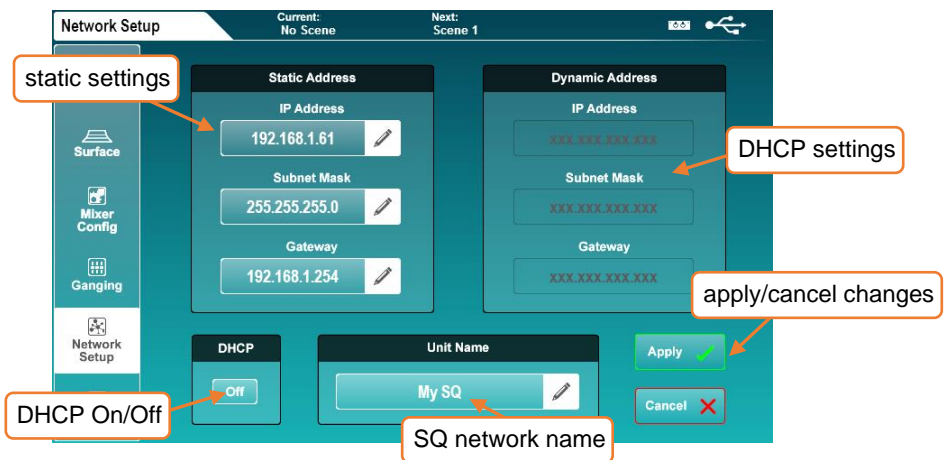

- Touch the DHCP On/Off button to switch DHCP mode on or off. Dynamic address values are displayed when DHCP is enabled and the SQ has been assigned an address. Static settings cannot be adjusted if DHCP mode is on.
- Touch any of the static network values to enter new values.
- Touch the **'Unit Name'** value to change the name of the SQ (as seen by other devices on the network including apps).
- Touch the **'Apply'** or **'Cancel'** button to apply or disregard any changes.

i When using a wireless router or access point, be sure to connect the SQ's 'Network' port to an available 'LAN' port. The network port 'Lnk' LED on the SQ will illuminate to show network activity.

12.15 User Permissions

Along with the Admin user, SQ can have 10 other users, each with individual permissions, passwords, scene access and user scenes (which are recalled on login).

These users can log in using the mixer itself as well as with any client connected to the SQ remotely, such as the SQ-MixPad and SQ4You remote apps. This means multiple users can be logged in on different devices at the same time.

Press the **'Setup'** screen key, then touch the **'Users'** tab to setup and configure users.

i User setup and permissions can only be carried out when logged in as Admin.

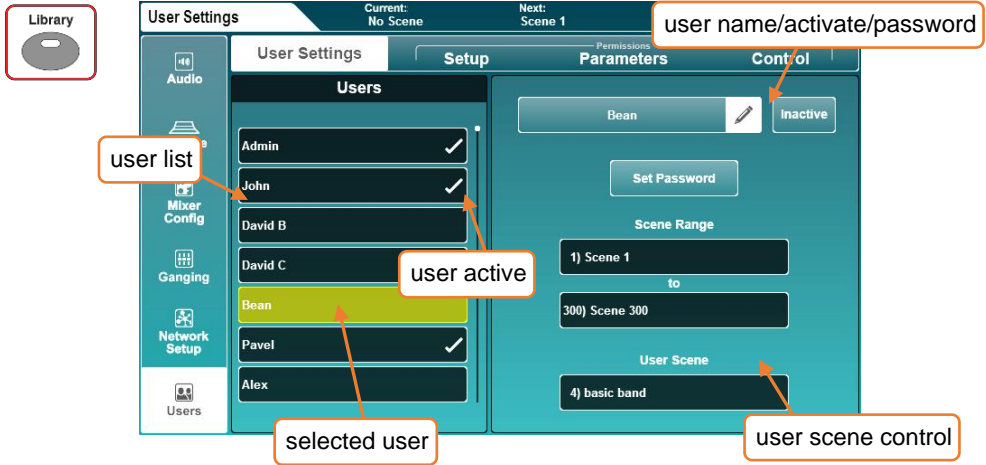

To change user settings and permissions, first select a user from the list on the left. You are now making changes for this user only, so the user list is visible in all tabs, allowing you to quickly compare users and change permissions at any point.

User Settings -

- Touch the user name value to change the name of the user.
- Touch the **'Inactive'** button to activate the user (button changes to **'Active'** and a tick appears in the list).
- Touch the **'Set Password'** button to set or change a password for the user. This password is used when logging in as well as when locking the desk.

i The Admin user is always active and has unrestricted access to all settings of the SQ.

i To remove a password, just set a blank password for the user.

- Use **'Scene Range'** to select a range of scenes that the user has access to (the default range is all 300 scenes).
 - If required, touch the **'User Scene'** value to choose a scene to load when the user logs in.
- ❗ When logging in as the same user multiple times (such as when the SQ has been powered off at the end of the day, and the same user logs in on the following day), a pop-up is presented to decide whether the SQ either recalls its previous state or the **'User Scene'** is reloaded.

User Permissions Library -

With one of the ten users selected, pressing the **'Library'** key will display the user permissions library. Factory presets are included as starting points and for quick setup, but you may also store and recall user presets.

- Select a preset and touch **'Recall'** to apply permission settings to the currently selected user.
 - Touch **'User'** to access the user library where you can manage your own presets.
- ❗ The user permissions library cannot be accessed when the Admin user is selected as the Admin cannot be blocked from using any parameters or features.

Permissions –

Touching the **'Setup'**, **'Parameters'** or **'Control'** tabs will display lists of parameters and features that can be set to **'Allow'** or **'Block'** on a per-user basis.

- Touch the **'Allow'/'Block'** button on the right to toggle access.

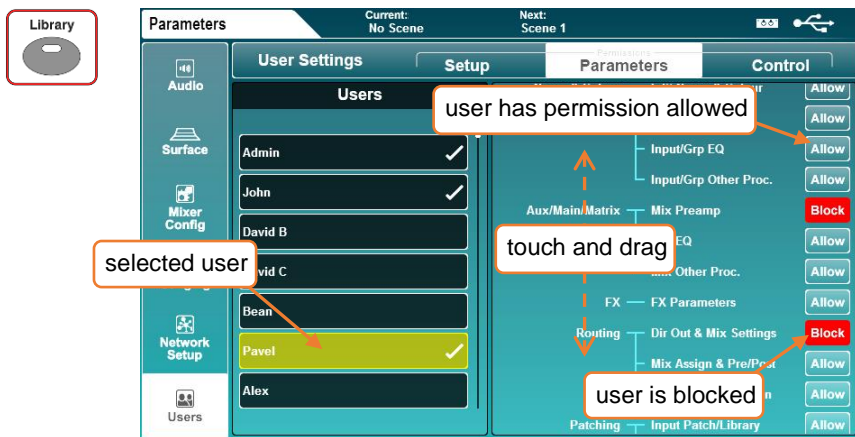

Setup
USB Data Recall
USB Data Store
USB Data Modify
Sync Push
Sync Pull
Scene Recall
Scene Store
Scene Modify
Global Filter
Channel Safes
Scene Preferences
Reset Mix Settings
Library Recall
Library Store
Library Modify
FX Library Recall
FX Library Store
FX Library Modify
Input Stereo
Mix Stereo
Bus Config
PAFL/Talkback Settings
Signal Generator
Audio Sync Options
Surface Strip Assign
Master Fader Mode
Soft Control Setup
MIDI Settings
Network Settings
I/O Port Settings
USB Format

Parameters
Name/Colour
Input/Group Preamp
Input/Group EQ
Input/Group Other Processing
Mix Preamp
Mix EQ
Mix Other Processing
FX Parameters
DirOut and Mix Settings
Mix Assign and Pre/Post
DCA/Mute Group Assign
Input Patching/Library
Output/Insert/FX Patching
USB Source
AMM Setup/Assign
AMM Parameters

Control
MixPad Access
SQ4You Access
Layers B-F*
Groups 1-12*
Auxes 1-12*
FX Sends 1-4*
Matrices 1-3*
SQ-Drive Playback
SQ-Drive Stereo Record
SQ-Drive Multitrack Record

*assignable per layer/mix

13. SQ-Drive and USB-B

SQ-Drive and USB-B make use of the same audio technology inside SQ, so they run exclusively from one another. Therefore, you must choose which mode the SQ is running in before recording or playing back any audio.

There are other bandwidth intensive tasks (such as formatting an SQ-Drive) that also require the mode to be changed.

Press the '**I/O**' screen key, then touch the USB tab to display USB input or output patching.

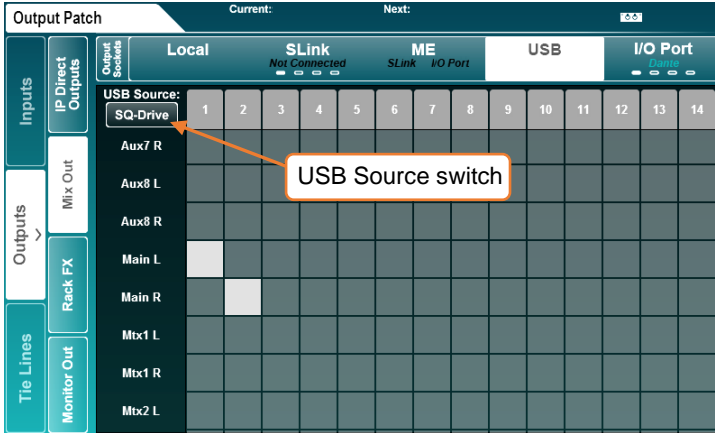

The '**USB Source**' switch displayed at the top left of the patching matrix shows the current mode.

- Touch the '**USB Source**' switch to change between '**SQ-Drive**' and '**USB-B**' mode.
- Audio patching for both the SQ-Drive and USB-B connection is the same.
- SQ-Drive utilises only the patching from channels 1 to 16 on both inputs and outputs. USB-B streaming can utilise all USB input and output channels (32 x 32).

13.1 SQ-Drive stereo recording and playback

Press the **'Utility'** screen key then touch the **'SQ-Drive'** tab followed by the **'Stereo'** tab to show the SQ-Drive Stereo record/playback screen.

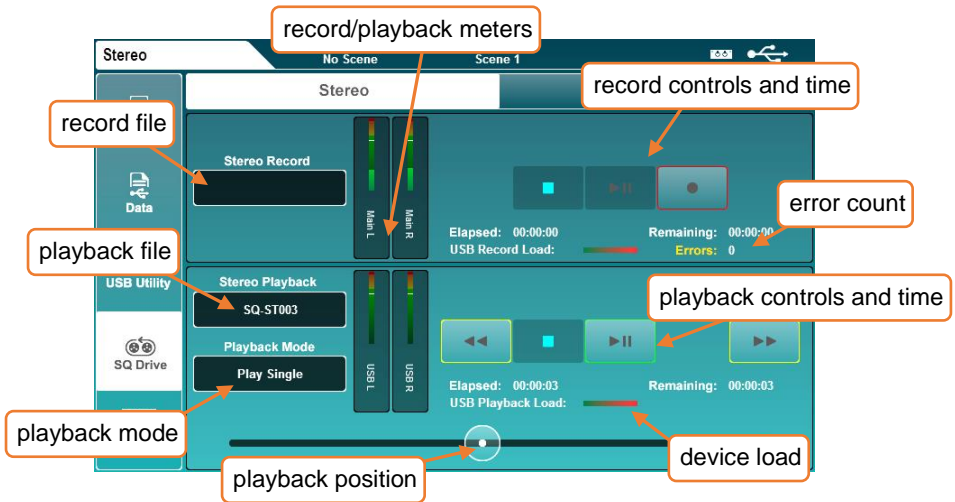

The top half of the screen is for recording and the bottom half is for playback.

Recording -

- Press the record button to arm recording, a new **'Stereo Record'** file name will appear, the **'Remaining'** time value will be displayed and the **'Errors'** counter will reset.
- Press the play/pause button to start recording, the **'Elapsed'** and **'Remaining'** time values will display progress.
- Press the stop button to stop recording.

❗ The device load meter indicates the suitability of the USB device for recording or playback of audio.

❗ The **'Errors'** counter increments with any detected writing error.

Playback –

- Touch the '**Stereo Playback**' file name value. Then touch the '**Playback**' or '**Recording**' button to view files in each folder (recordings you have made with the SQ are displayed in the '**Recordings**' folder).
- Touch a track to highlight it.
- Touch the '**Select**' button to load the highlighted track.
- Touch the '**Playback Mode**' value to select a mode.

Play All = Play all tracks in the folder consecutively.

Play Single = Play the selected track then stop.

Repeat All = Repeatedly play all tracks in the folder consecutively.

Repeat Single = Repeatedly play the selected track.

- Touch the transport buttons to go to the previous or next track, or to stop or play/pause.
- Touch and drag the circular playback position marker to jump to a different point in the track.

Formats and folders –

SQ-Drive stores stereo recordings to '<SQ-DRIVE>:\AHSQ\USBREC'.

These are 96kHz 24bit stereo *.wav files, named sequentially in the order recorded i.e. SQ-ST001.WAV, SQ-ST002.WAV...

Files for stereo playback copied from a computer should be placed in '<SQ-DRIVE>:\AHSQ\USBPLAY'.

These can be mono or stereo, uncompressed PCM *.wav files, 44.1, 48 or 96kHz and 16 or 24-bit.

They must not contain any headers (such as BWF) or data (such as markers).

Length of recording –

The maximum length of a stereo recording is approximately 2 hrs and will use around 4GB of storage.

13.2 SQ-Drive multitrack recording and playback

Press the **'Utility'** screen key then touch the **'SQ-Drive'** tab followed by the **'Multitrack'** tab to show the SQ-Drive multitrack record/playback screen.

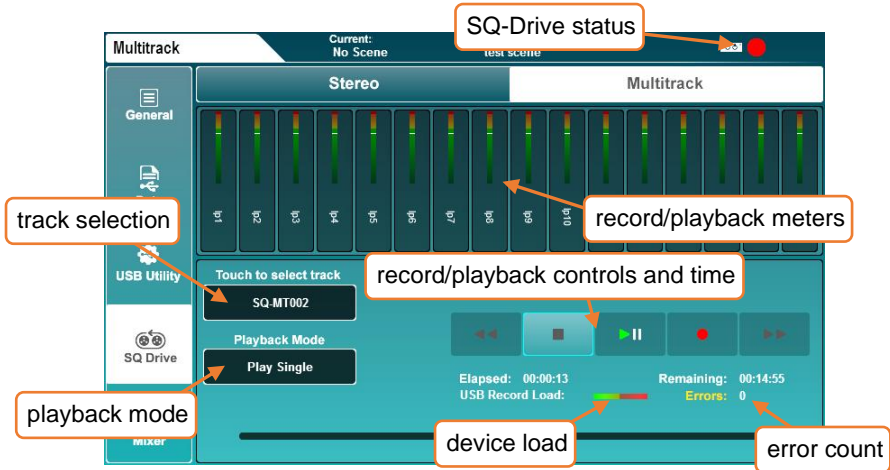

Recording -

- Press the record button to arm recording. A new multitrack file name will appear, the **'Remaining'** time value will be displayed and the **'Errors'** counter will reset.
- Press the play/pause button to start recording. The **'Elapsed'** and **'Remaining'** time values will display progress.
- Press the stop button to stop recording.

ⓘ Allow the write process to complete before recording again or removing the device.

Playback -

- Touch the multitrack file name value. Touch a track to select it, then scroll through the list of tracks using the touchscreen rotary if needed.
- Touch the **'Select'** button to load the track.
- Touch the **'Playback Mode'** value to select a mode.

Play All = Play all tracks in the folder consecutively.

Play Single = Play the selected track then stop.

Repeat All = Repeatedly play all tracks in the folder consecutively.

Repeat Single = Repeatedly play the selected track.

- Touch the transport buttons to go to the previous or next track, or to stop or play/pause.
- Touch and drag the circular playback position marker to jump to a different point in the track.

- ❗ The device load meter indicates the suitability of the USB device for recording or playback of audio.
- ❗ The '**Errors**' counter increments with any detected writing error.
- ❗ Not all USB devices are capable of the high bandwidth used by the SQ-Drive multitrack recording feature. For best results when multitrack recording direct to USB, use a high-speed external hard drive rather than a USB stick/'pen' drive.

Formats and folders –

SQ-Drive stores multitrack recordings to separate folders in the parent folder '<SQ-DRIVE>:\AHSQ\USBMTK'. Folders are named sequentially in the order recordings are made. i.e. 'SQ-MT001', 'SQ-MT002'...

Sixteen 96kHz 24bit mono uncompressed PCM *.wav files are recorded – with naming based on the USB channel i.e. 'TRK01.WAV', 'TRK02.WAV'...

They do not contain any headers (such as BWF) or data (such as markers).

Files for multitrack playback copied from a computer should follow this exact formatting, naming and folder structure. Files must also be exactly the same size/length and all sixteen files must be present, even if they contain no audio.

Length of recording –

The maximum length of a multitrack recording is approximately 4 hrs and will use around 64GB of storage.

13.3 Connecting to a computer

To stream audio to and from a computer, it needs to be connected to the SQ using a USB-A to USB-B cable.

SQ conforms to USB 2.0 standards, so it is recommended to use a high-speed USB cable. Depending on the environment the system is being used in, it may also be beneficial to use a cable which features a ferrite bead.

- i** Note that not all USB 3.0 ports are fully backward compatible with USB 2.0 – for best results, it is therefore recommended that a USB 2.0 port is used where available. Where unavailable, USB 3.0 ports utilising xHCI host controller drivers should be avoided as many are known not to support the isochronous transfer method used for streaming audio.

To connect SQ to a mac –

The SQ is Core Audio compliant so drivers are not required.

Connect the SQ via USB and it will appear as both an audio and a MIDI device.

To connect SQ to a Windows PC –

Visit the Allen & Heath website (www.allen-heath.com) to download the latest SQ Windows ASIO/WDM drivers.

Follow the instructions to install the drivers before connecting the SQ.

Routing –

- It is important to note when patching, that outputs from the computer are inputs on the SQ and outputs on the SQ are inputs on the computer.
- All USB I/O must be patched to function, though by default, SQ input channels 47 and 48 are sourced from USB channels 1 and 2, and USB output channels 1 and 2 are fed from the Main LR mix.
- When using WDM drivers to utilise the SQ for Windows system/default sound, only USB channels 1 and 2 are used on the SQ. To make use of all 32 input and 32 output channels, the ASIO driver must be used with a compatible program.
- When selecting the SQ as the default output audio device on a mac, USB channels 1 and 2 are used by default.

14. MIDI and DAW Control

When connected to a computer either via USB or TCP/IP, the SQ sends and receives MIDI control messages.

These can be broken down into two sets of bi-directional messages. Those that are used to control the SQ, and those used to control external software or equipment.

- ❗ Please refer to the separate SQ MIDI Protocol document for more information on all SQ MIDI communication.

14.1 MIDI channel and MMC

Press the **'Utility'** screen key, then touch the **'General'** tab followed by the **'MIDI'** tab to view and adjust the MIDI channel setting. This screen also displays MMC (MIDI Machine Control) buttons for control of computer sequencers and DAW's.



- Touch the **'MIDI Channel'** value and use the touchscreen rotary to adjust.
- Touch the **'Apply'** or **'Cancel'** buttons to apply or disregard changes.
- ❗ Note that the channel used by the Allen & Heath DAW Control Driver (and therefore all MIDI fader strips) is always one more than the MIDI Channel the rest of the SQ is set to. To use MIDI channel 1 for the DAW Control Channel, set the main SQ MIDI channel to 16.
- Touching any of the MMC Controls sends standard MMC transport messages to all channels. These are also translated by the DAW control driver to specific transport messages for the control surface emulation being used.

14.2 MIDI fader strips

The SQ has 32 available MIDI fader strips that can be assigned anywhere in the fader strip layers.

These transmit standard MIDI messages over USB and TCP/IP when 'Mute', 'Sel' or 'PAFL' keys are pressed, or when the fader strip fader is adjusted. They also respond to the same messages.

- Messages can be used as-is, and 'learnt' by software for control.
- By default, these messages are transmitted on MIDI Channel 2.
- Pressing a key will send a note on followed by a note off, moving a fader sends a continuous change message.

SQ MIDI Fader Strip Control	MIDI message
Mute keys 1 to 32	Note On/Off 0 (C-1) to 31 (G1)
Sel keys 1 to 32	Note On/Off 32 (G#1) to 63 (Eb4)
PAFL keys 1 to 32	Note On/Off 64 (E4) to 95 (B6)
Faders 1 to 32	CC 00 to CC 31

14.3 DAW Control

MIDI fader strips can also be used with the Allen & Heath DAW Control Driver. This translates the messages from the MIDI strip and emulates standard control surface messages for use with a DAW.

Visit www.allen-heath.com to download the latest DAW Control Driver and view instructions for installation and correct setup.

It is worth noting that **SoftKeys** can also be assigned to send MMC messages or 'Bank Up', 'Bank Down' messages.

- ❗ Only the MIDI fader strips, MMC controls and specific SoftKey assignments are intended for use with the DAW Control Driver. Other physical controls (such as EQ rotaries) continue to work with the SQ itself.
- ❗ DAW Control Driver V1.60 or above is required to select SQ in the 'Mixer' field of the preferences. On earlier versions, selecting 'Qu' will allow correct operation as both Qu and SQ send the same MIDI messages from MIDI channel strips.

14.4 MIDI from Soft Controls

Soft Rotaries and Soft Rotary keys can be used to transmit MIDI messages over USB and TCP/IP, including Continuous Controller values and MIDI Machine Code.

This allows them to be used for control external equipment or software.

- ❗ See the [SoftKeys/SoftRotaries](#) section for details.

15. Automatic Microphone Mixing (AMM)

Automatic Microphone Mixing provides automated level control of multiple microphone channels. It is designed for use in multichannel speech applications such as conferences or panel discussions.

The AMM's in SQ use the D-Classic gain sharing algorithm to increase the level of active channels whilst simultaneously decreasing the levels of any other assigned channels. Priority levels can also be set to prioritise certain AMM slots over others.

SQ has 2 AMM's with up to 24 channels each, these can also be combined for use as a single 48 channel AMM, and use DEEP processing, so no latency is added.

i AMM is not intended for use with instruments or signal sources other than speech.

15.1 AMM Input Assign

Any input channel can be assigned to an AMM. Due to AMM being embedded directly in the channel (post-delay/pre-fader), PFL can be affected by the changes in level. Therefore, we recommend that channels are set up before being added to an AMM.

To assign input channels, press the **'Utility'** screen key, then touch the **'AMM'** tab followed by the **'Input Assign'** tab.

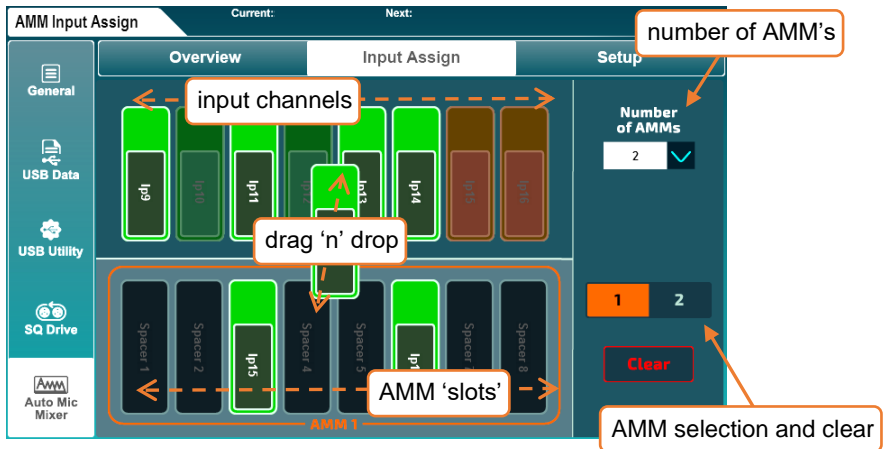

The top part of the screen shows the available input channels and at the bottom are available AMM slots.

Select either **'2'** (2 x 24 channel) or **'1'** (1 x 48 channel) AMM from the **'Number of AMMs'** dropdown.

Assigning/unassigning channels -

- If using 2 AMM's, use the AMM selection buttons to choose which AMM to display.
 - Touch and drag left or right to show all input channels and AMM slots.
 - Touch and drag input channels from the top to AMM slots at the bottom to assign a channel.
- ❗ Input channels can be freely assigned to any AMM slot, they do not need to be assigned sequentially.
- ❗ Dropping channels into a slot that already has a channel assigned, automatically unassigns the previously assigned channel.
- Touch and drag channels from assigned slots back to the top to unassign.
 - Touch the '**Clear**' button to clear all channels from the selected AMM.

15.2 AMM Overview

Press the '**Utility**' screen key, then touch the '**AMM**' tab followed by the '**Overview**' tab.

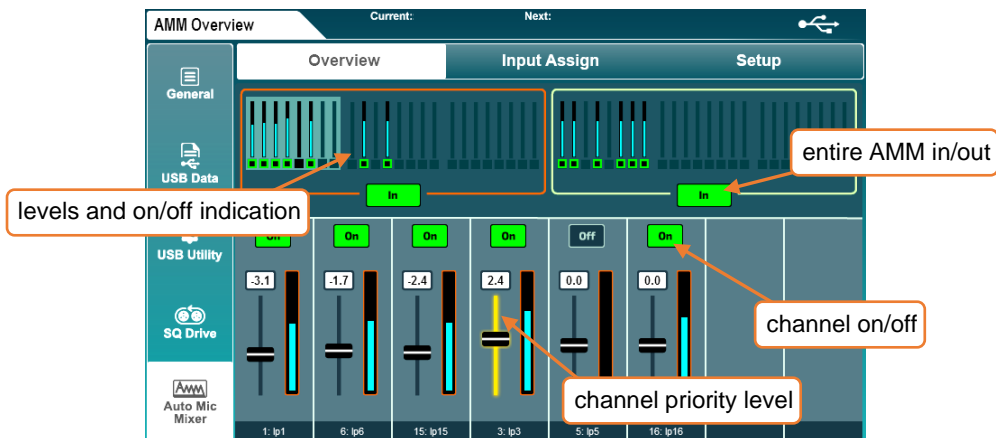

The top part of the screen displays an overview of all AMM slots, with the metering showing gain being applied to channels and indication of whether or not channels have AMM switched on.

- Touch an AMM 'In/Out' button to switch all AMM channels in or out.
- ❗ If a channel has AMM switched on and is assigned to an AMM which has all channels switched in, this is indicated in the channel overview shown in the '**Processing**' screen.

- Touch a block of 8 AMM channels at the top to display these in the bottom half of the screen.
- Touch a slot 'On/Off' button to add or remove it's channel from the AMM. Channels have AMM automatically set to 'On' when they are assigned.
- Touch a slot fader and adjust using the touchscreen rotary to increase or decrease gain, and therefore slot priority in the AMM calculation.

Priority level = -15 to +15

15.3 AMM Setup

Press the 'Utility' screen key, then touch the 'AMM' tab followed by the 'Setup' tab.

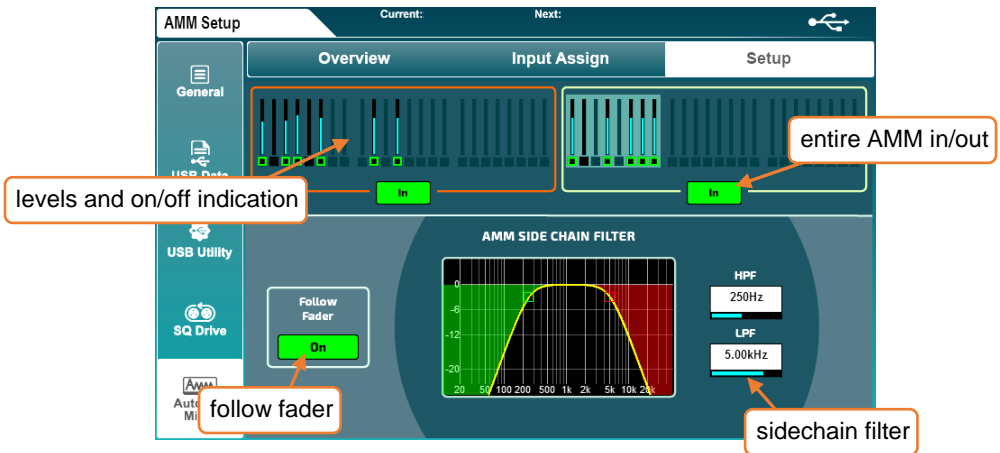

Like the 'Overview' screen, this displays an overview of all AMM slots, with gain metering and indication of whether or not channels have AMM switched on.

- Touch an AMM 'In/Out' button to switch all AMM channels in or out.
- Touch the global Follow Fader 'On' button to choose whether or not the side chain is affected by channel fader position.
- Touch High Pass Filter or Low Pass Filter frequency values and adjust using the touchscreen rotary to filter unwanted frequencies from the side chain.

HPF = 20Hz to 5kHz
 LPF = 120Hz to 20kHz

ⓘ The AMM side chain is fed from the channel at the post-HPF point, and automated gain is applied at the post-delay point.

16. Add-ons

Optional add-ons for the SQ are available to purchase, allowing customisation of each unit through the addition of special processing and DEEP models.

i To ensure the latest units and models are available, install the latest version of [firmware](#).

Press the **'Utility'** screen key, then touch the **'General'** tab followed by the **'Add-ons'** tab.

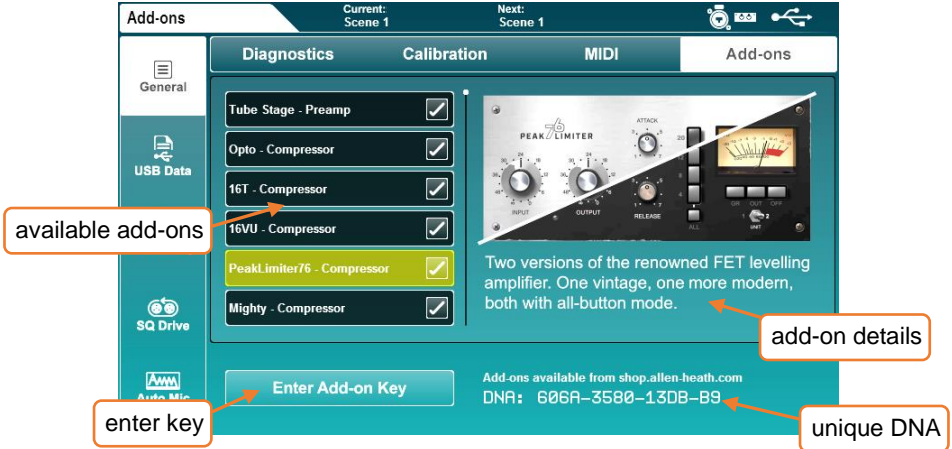

i Available add-ons for the SQ are shown to the left, touch to display more information and use the touchscreen rotary to scroll through.

i For more detailed information and audio samples of any plugin, visit shop.allen-heath.com.

Activating an add-on-

- Note the unique DNA for the SQ and visit shop.allen-heath.com to purchase add-ons and obtain a unique key.
- Touch **'Enter Key'** then enter the 16-character key and touch **'OK'** to activate.

Keys are unique to each SQ, and only ever need to be entered once. They will not need to be re-entered when updating firmware or after a system reset.

17. Mix/System Reset

17.1 Reset Mix Settings

The SQ has multiple 'Reset Mix Settings'. These are used to 'zero the desk' for different uses.

This will clear the current state of the SQ, but does not affect stored Scene or Library data, so save the current settings

Press the '**Setup**' screen key, then touch the '**Mixer Config**' tab followed by the '**Role**' tab.

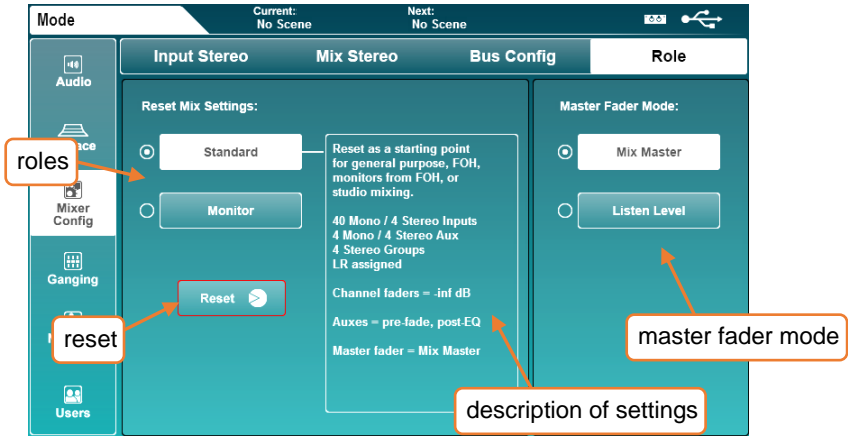

Select an operating role and information on default settings will be displayed. Touch the '**Reset**' button to reset the mix with these settings.

Global filters are ignored and safes are all switched off when mix settings are reset.

- ❗ The Master Fader Mode allows you to choose whether the master fader controls the master send level of the selected mix, or the level of the listen bus. For more information see the [Mixer Role](#) section.

Reset Mix Settings: Standard

Routing	Setting
Input Stereo	40 mono (1-40), 4 stereo (ST1, ST2, ST3, USB)
Local Input patching	1 to 1 (as labelled), then unassigned to 46
Mix Bus Configuration	Aux 1-4 (mono), Aux 5-8 (stereo), Group 9-12 (Stereo)
LR Assign	All inputs and groups assigned
Aux assign and send	Inputs to all Aux, Pre-Fade, Post-EQ
Local Output patching (Aux)	1 to 1 for mono then sequential stereo
Local Output patching (Main)	11 (Main L) & 12 (Main R)
Local Output patching (Matrix 1)	A & B
AES output	Main LR
Remote Audio Unit Inputs	Unassigned
Remote Audio Unit Outputs	Unassigned
SQ to USB	Main LR on 1 & 2, then 1 to 1 direct out
USB to SQ	USB 1 & 2 to input channels 47 & 48

Processing type	Setting
48v	All off
Preamp gains	+28dB
HPFs	Out/100Hz
Gates	Out/-30dB
Inserts	Out
PEQs	In/Flat
GEQs	In/Flat
Compressors	Out/3:1/-9dB
Pans	Centred

FX unit	Setting
1	EMT 250 reverb/FX1Snd/FX1Rtn
2	Hall 480 reverb/FX2Snd/FX2Rtn
3	Stereo Tap Vocal Delay/FX3Snd/FX3Rtn
4	ADT Classic/FX4Snd/FX4Rtn
5-8	Empty/Unpatched

Control	Setting
SoftKeys 1-6	Mute Groups 1 to 6
SoftKey 7	Unassigned
SoftKey 8	Global Tap Tempo
SoftKeys 9-16	Unassigned
SoftRotaries	Unassigned
Master Fader Mode	Mix Master

Send type	Level
Input channels	-inf
FX return channels	0dB
Main LR master	0dB
Aux master	0dB
Group master	-inf
FX master	0dB

Reset Mix Settings: Monitor

Routing	Setting
Input Stereo	48 mono (1-48)
Local Input patching	1 to 1 (as labelled), then unassigned to 48
Mix Bus Configuration	Aux 1-6 (mono), Aux 7-12 (stereo)
LR Assign	All inputs unassigned
Aux assign and send	Inputs to all Aux, Post-Fade, Post-Delay
Local Output patching (Aux)	1 to 1 for mono then sequential stereo
Local Output patching (Listen M)	12
Local Output patching (PAFL)	A & B
AES output	Main LR
Remote Audio Unit Inputs	Unassigned
Remote Audio Unit Outputs	Mixes 1 to 1, then Main LR on last 2 sockets.
SQ to USB	Unassigned
USB to SQ	Unassigned

Processing type	Setting
48v	All off
Preamp gains	+28dB
HPFs	Out/100Hz
Gates	Out/-30dB
Inserts	Out
PEQs	In/Flat
GEQs	In/Flat
Compressors	Out/3:1/-9dB
Pans	Centred

FX unit	Setting
1-4	EMT 250 reverb/FXSnd 1-4/FXRtn 1-4
5-8	Empty/Unpatched

Control	Setting
SoftKeys 1-8	Mute Groups 1 to 8
SoftKeys 9-16	Unassigned
SoftRotaries	Unassigned
Master Fader Mode	Listen Level

Send type	Level
Input channels	0dB
FX return channels	0dB
Main LR master	0dB
Aux master	0dB
Group master	-inf
FX master	0dB

17.2 System reset

To perform a full system reset, hold the EQ **'In'** and **'HF'** keys when powering on the SQ. This will clear all mix settings and all saved data, including Shows/Scenes and Libraries, and will revert the SQ to its initial state.

Before you carry out a system reset, back-up any data you wish to keep using a USB device or SQ-MixPad.

- ❗ See the [Data transfer \(USB/MixPad\)](#) section for more information on storing data.
- ❗ System resets do not remove [add-ons](#).

17.3 Fader Calibration

Occasionally faders can become misaligned or behave incorrectly, this can happen for many reasons and is usually nothing to be concerned about. However, it may necessitate a re-calibration.

- 1) Press the **'Utility'** screen key, then touch the **'General'** tab followed by the **'Calibration'** tab.
- 2) Touch the **'Calibrate'** button and follow the on-screen instructions, positioning the faders at +10dB, 0dB, -10dB, -30dB and -inf when prompted.

18. Block Diagrams

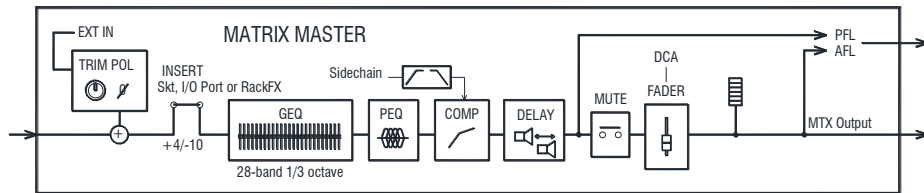
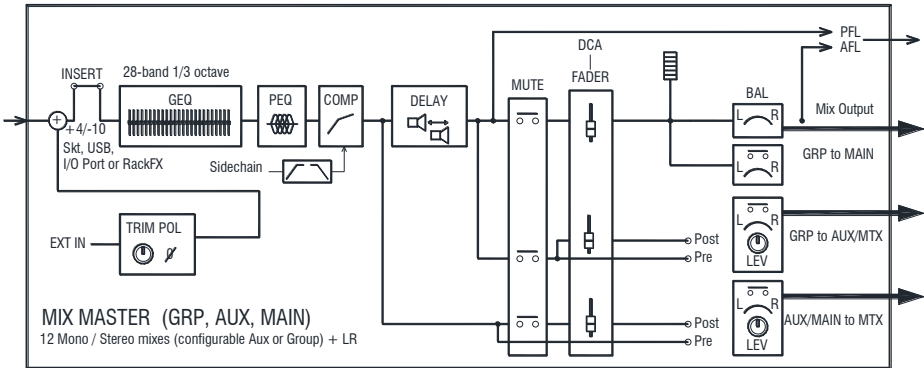
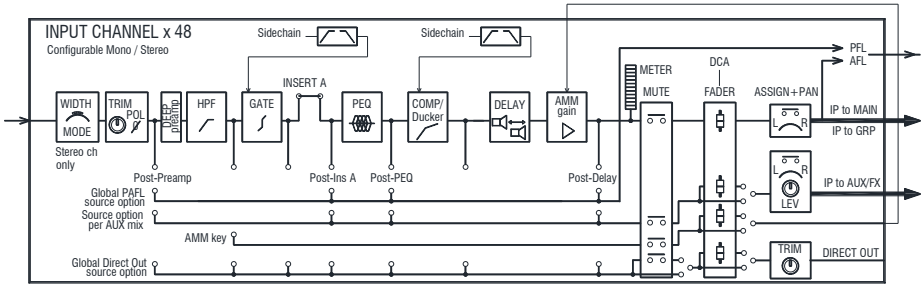

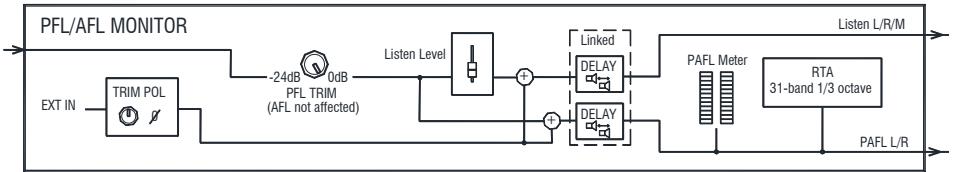
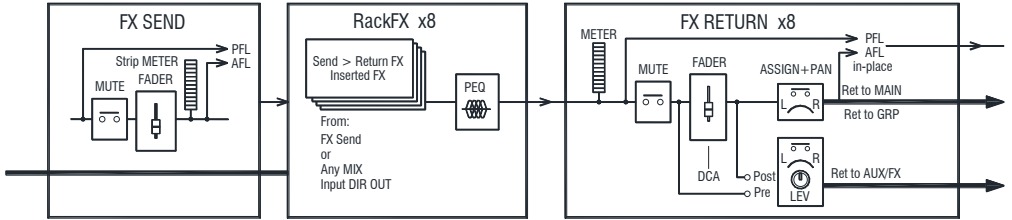
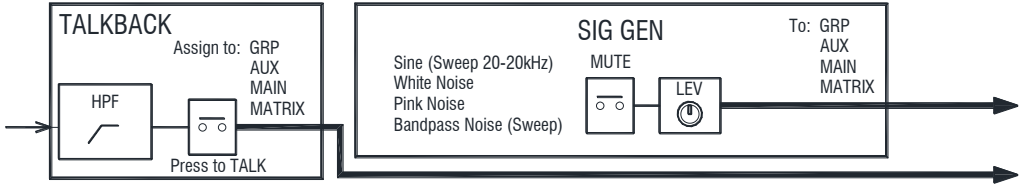

19. Specifications

Mic/Line Inputs	Balanced XLR, fully recallable
Input Sensitivity	-60 to +0dBu
Switchable Pad	-20dB
Analogue Gain	0dB to +60dB, 1dB steps
Maximum Input Level	+30dBu
Input Impedance	>5k Ω
THD+N, Unity gain 0dB	0.002% -92dBu (20Hz-20kHz, AES Direct Out, @0dBu 1kHz)
THD+N, Mid gain +30dB	0.003% -91dBu (20Hz-20kHz, AES Direct Out, @-30dBu INPUT 1kHz)
Phantom Power	+48V (+3V / -2V)
Stereo Line Inputs	
ST1, ST2 connectors	Balanced, 1/4" TRS jack
ST3 connector	Unbalanced, stereo 3.5mm Mini Jack
Input Sensitivity (ST1, ST2 / ST3)	Nominal +4dBu ST1, ST2 / 0dBu ST3
Trim	+/-24dB
Maximum Input Level (ST1, ST2 / ST3)	+22dBu / +18dBu
Input Impedance	>7k Ω
Outputs 1-12 (SQ-5) and 1-14 (SQ-6)	Balanced, XLR
Outputs A and B	Balanced 1/4" TRS Jack
Source	Patchable
Output Impedance	<75 Ω
Nominal Output	+4dBu = 0dB meter reading
Maximum Output Level	+22dBu
Residual Output Noise	-90dBu (muted, 20Hz-20kHz)
AES Digital Output	Balanced XLR 2 channel, 96kHz sampling rate (Default with SRC Bypassed) Switchable output sample rates, 44.1kHz/ 48kHz/ 88.2kHz/ (96kHz) 2.5Vpp balanced terminated 110 Ω

SLink Connection	Neutrik EtherCON (RJ45)
dSnake mode (48kHz devices)	40 input 20+40(ME) output channels
dx mode (96kHz devices)	32 input 32 output channels
gigaACE/GX mode (96kHz devices)	128 input 128 output channels
Inputs	Fully Patchable
Outputs	Fully Patchable
Sync/SRC	Assignable as master audio sync for all modes, SRC 64 channel
I/O Port	Multi-channel IO option module
Inputs	Fully Patchable
Outputs	Fully Patchable
Sync/SRC	Assignable as master audio sync
System	Measured balanced XLR in to XLR out, 0dB gain, 0dBu input
Dynamic Range	112 dB
Frequency Response	+0/-0.5dB 20Hz to 20kHz
Headroom	+18dB
Internal operating Level	0dBu
THD+N, Mic/Line routed to Main L/R Out	Unity gain faders@0dB, 0.006%, -84dBu (20 - 20kHz)
dBFS Alignment	+18dBu = 0dBFS (+22dBu at XLR output)
Meter Calibration	0dB meter = -18dBFS (+4dBu at XLR out)
Main Meter Type	2 x 12 segment, fast (peak) response
Channel Meter Type	Chromatic Channel Metering, fully programmable colour/brightness
Peak Indication	-3dBFS (+19dBu at XLR out), multi-point sensing
Sampling Rate	96kHz
Bit Depth	Uses XCVI core custom bit widths in algorithms, up to 96bits
Latency	<0.7mS, Local Mic Input routed to Main L/R. (Direct, No EQ/ Effects)
Operating Temperature Range	0 deg C to 40 deg C (32 deg F to 104 deg F)
Mains Power	100-240V AC, 50/60Hz
Max Power Consumption SQ-5/SQ-6/SQ-7	75W / 90W / 110W

Input Processing

Source

CH1-48	Fully patchable
USB Global Source	SQ-Drive or USB-B Streaming

Polarity

Normal/Invert

Trim

-24 to +24dB

High Pass Filter

12dB/octave 20Hz – 2kHz

Insert (Pre EQ/Comp)

Fully Patchable

Delay

Up to 341ms

Gate

Patchable Sidechain

Sidechain filter

Hi-pass (20-5k), Band-pass (120-10k), Lo-pass (120-20k)

Threshold / Depth

-72dBu to +18dBu / 0 to 60dB

Attack / Hold / Release

50 μ s to 300ms / 10ms to 5s / 10ms to 1s

PEQ

4-Band fully parametric, 20-20kHz, +/-15dB

Band 1, Band 4

Selectable Shelving (Baxandall), Bell

Band 2, Band 3

Bell

Bell Width

Variable Q, 1.5 to 1/9th octave

Compressor

Patchable Sidechain, DEEP options

Sidechain filter

Hi-pass (20-5k), band-pass (120-10k), Lo-pass (120-20k), Q=1

Threshold / Ratio

-46dBu to 18dBu / 1:1 to infinity

Attack / Release

30 μ s to 300ms / 50ms to 2s

Knee

Soft/Hard

Detector response

Peak/RMS switchable

Parallel Path Compression

dry/wet -inf to 0dB

Channel Direct Out

Follow Fader, Mute, Mute Group, DCA (global all ch)

Source select

Post-Preamp, Post-HPF, Post-Gate, Insert Return, Post-PEQ, Post-Comp, Post-Delay
trim -inf to 10dB per channel

Mix Processing

Insert (Pre EQ/Comp)	Fully Patchable
Delay	Up to 682ms
GEQ	28 bands 31Hz-16kHz, +/-12dB Gain, Constant 1/3 oct, DEEP options
PEQ	As Input PEQ
Compressor	As Input Compressor

FX

Internal FX	8 x RackExtra FX engine, Send>Return or Inserted (4 dedicated FX bus)
Types	SMR Reverb, Gated Reverb, Stereo Tap Delay, ADT, Blue Chorus, Symphonic Chorus, Flanger, noo Phaser
8 dedicated Stereo FX returns	Fader, Pan, Mute, Routing to Mix/LR, 4-Band PEQ

Audio Tools

PAFL	PFL or stereo in-place AFL, 0 to -24dB Trim, PAFL Delay Up to 682ms
Talkback	Dedicated input, Assignable to any mix, Gain, Pad, 48V, 12dB/oct HPF
Signal Generator	Assignable to any mix, Sine/White/Pink/Bandpass Noise
RTA	31-Bands 1/3 octave 20-20kHz, follows PAFL source

AMMs

Configuration	2x 24ch or 1x 48ch, freely assignable
Mode	Gain Sharing
Sidechain Filter HPF / LPF	12dB/octave 20Hz – 5kHz / 120Hz - 20kHz
Priority	-15dB to +15dB per channel

Add-ons

DEEP Preamps	Tube Stage
DEEP Compressors	Opto, 16T, 16VU, PeakLimiter76, Mighty
DEEP GEQ's	Proportional-Q, DiGi-GEQ, Hybrid
RackFX units	De-Esser, DynEQ4, MultiBD3, MultiBD4

USB Audio

SQ-Drive

	USB A
Stereo Record	2 channel, WAV, 96kHz, 24-bit, source fully patchable
Stereo Playback	1/2 channel, WAV, 44.1, 48, 96kHz 16, 24-bit, fully patchable
Multitrack Record	16 channel, WAV, 96kHz, 24-bit, track sources fully patchable
Multitrack Playback	16 channel, WAV, 96kHz, 24-bit fully patchable

USB Audio Streaming

	USB B, Core Audio compliant, ASIO/WDM for Windows
Send (upstream)	32 channel, 96kHz, 24-bit
Return (downstream)	32 channel, 96kHz, 24-bit

Size and Weight

SQ-5

	Width x Depth x Height
Desk mounted	440 x 514.9 x 198 mm (17.3" x 20.3" x 7.8")
Packed in shipping box	610 x 680 x 360 mm (24" x 26.8" x 14.2")
Unpacked weight	10.5 kg (23.1 lbs)
Packed weight	14 kg (30.9 lbs)

SQ-6

	Width x Depth x Height
Desk mounted	638 x 514.9 x 198 mm (25.1" x 20.3" x 7.8")
Packed in shipping box	820 x 680 x 360 mm (32.3" x 26.8" x 14.2")
Unpacked weight	14.5 kg (32 lbs)
Packed weight	17.3 kg (38.1 lbs)

SQ-7

	Width x Depth x Height
Desk mounted	804 x 514.9 x 198 mm (31.7" x 20.3" x 7.8")
Packed in shipping box	960 x 685 x 360 mm (37.8" x 27" x 14.2")
Unpacked weight	17.8 kg (39.3 lbs)
Packed weight	21.9 kg (48.3 lbs)

Limited One Year Manufacturer's Warranty

Allen & Heath warrants the Allen & Heath -branded hardware product and accessories contained in the original packaging ("Allen & Heath Product") against defects in materials and workmanship when used in accordance with Allen & Heath's user manuals, technical specifications and other Allen & Heath product published guidelines for a period of ONE (1) YEAR from the date of original purchase by the end-user purchaser ("Warranty Period").

This warranty does not apply to any non-Allen & Heath branded hardware products or any software, even if packaged or sold with Allen & Heath hardware.

Please refer to the licensing agreement accompanying the software for details of your rights with respect to the use of software/firmware ("EULA").

Details of the EULA, warranty policy and other useful information can be found on the Allen & Heath website: www.allen-heath.com/legal.

Repair or replacement under the terms of the warranty does not provide right to extension or renewal of the warranty period. Repair or direct replacement of the product under the terms of this warranty may be fulfilled with functionally equivalent service exchange units.

This warranty is not transferable. This warranty will be the purchaser's sole and exclusive remedy and neither Allen & Heath nor its approved service centres shall be liable for any incidental or consequential damages or breach of any express or implied warranty of this product.

Conditions of Warranty

The equipment has not been subject to misuse either intended or accidental, neglect, or alteration other than as described in the User Guide or Service Manual, or approved by Allen & Heath. The warranty does not cover fader wear and tear.

Any necessary adjustment, alteration or repair has been carried out by an authorised Allen & Heath distributor or agent. The defective unit is to be returned carriage prepaid to the place of purchase, an authorised Allen & Heath distributor or agent with proof of purchase. Please discuss this with the distributor or the agent before shipping. Units returned should be packed in the original carton to avoid transit damage.

DISCLAIMER: Allen & Heath shall not be liable for the loss of any saved/stored data in products that are either repaired or replaced.

Check with your Allen & Heath distributor or agent for any additional warranty information which may apply. If further assistance is required, please contact Allen & Heath Ltd.

Any changes or modifications to the equipment not approved by Allen & Heath could void the compliance of the product and therefore the user's authority to operate it.

SQ Reference Guide, Firmware V1.4.0, issue 5.

Copyright © 2019 Allen & Heath. All rights reserved.

ALLEN & HEATH

Allen & Heath Limited, Kernick Industrial Estate, Penryn, Cornwall, TR10 9LU, UK

www.allen-heath.com