

PRELIMINARY

# SYVA SEGMENT SOURCE SYSTEM



- L-Acoustics line source heritage
- 142 dB max SPL down to 35 Hz
- 35 m throw capability
- Exceptional coverage capability
- Streamlined design
- Plug-and-play package



## ELECTRO-ACOUSTICS



Syva is a segment source system (patent pending) suited to medium throw applications. It is designed for professional sound reinforcement and high-end residential applications requiring high fidelity and SPL with minimum visual impact.

The Syva enclosure features six 5" MF speakers providing usable bandwidth to 87 Hz and three 1.75" HF diaphragm compression drivers, loaded by DOSC waveguides in a J-shaped progressive curvature. This transducer arrangement, called segment source, produces an H/V 140° x 26° (+5/-21°) directivity pattern, optimized for ultra-wide horizontal coverage with extended throw capability.

The Syva Low enclosure features two K2 12" drivers and is designed to provide low frequency contour and extended bandwidth to the Syva system (9 dB contour with a low frequency limit at 40 Hz).

The Syva Sub enclosure features one high excursion 12" driver equipped with a KS28 woofer motor and is designed to further extend the bandwidth of the system in the sub frequency domain down to 27 Hz.

Both feature a bass-reflex cabinet equipped with L-Vents, reducing turbulence and port noise at high levels while increasing LF efficiency.

L-Acoustics amplified controllers ensure advanced crossover functions, time alignment, linearization and L-Drive protection of the transducers.

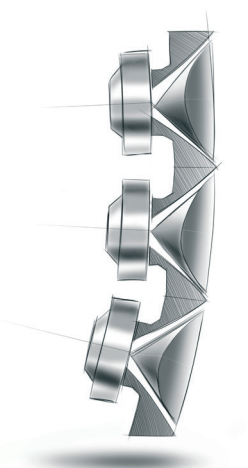

Syva combines the directivity benefits of line length and the coupling of HF DOSC waveguides to achieve a narrow vertical beam that is perfectly controlled down to 300 Hz. Syva focuses energy toward the back of the audience while providing smooth down-fill coverage to the front. Throw and SPL consistency are ensured from front, to back. The combination of extended 35 m throw and ultra-wide horizontal dispersion provides exceptional surface coverage for flat audiences.

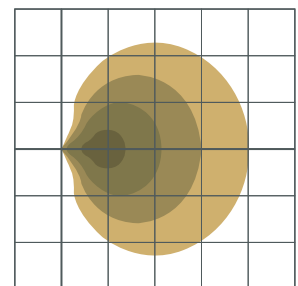
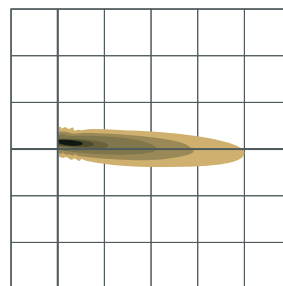

Syva vertical and horizontal SPL mappings from 1 kHz - 10 kHz. Scale: one square = 10 m (30 feet) and 3 dB per color. Design optimized for 5 to 40 m coverage, with base of Syva at 1 m above target audience zone.

# PHYSICAL



The cabinet combines the remarkable acoustic properties of birch and beech plywood. Its slim elegance makes for easy integration. RAL colors allow it to blend into any architecture. Syva Low and Syva Sub provide a stable podium base for Syva. The plug-and-play AutoConnect link provides a rapid and secure audio and physical link.

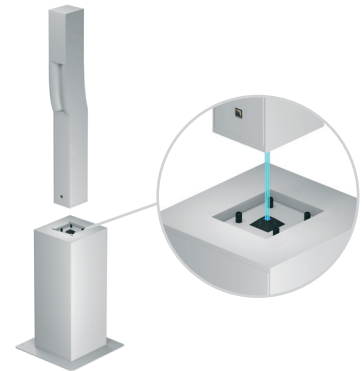

# APPLICATIONS AND BENEFITS

In fixed installations Syva is particularly suited to sound reinforcement in architectural settings and acoustically challenging environments where a combination of high intelligibility, high SPL and extended bandwidth are required. Its high fidelity sonic signature and elegant lines can satisfy high-end residential projects as well as L-ISA immersive multi-channel systems.

For rental events, Syva is fast to deploy and simple to rig. Its outstanding throw capability can satisfy production needs in large spaces and ballrooms where elegance and discretion are a must.

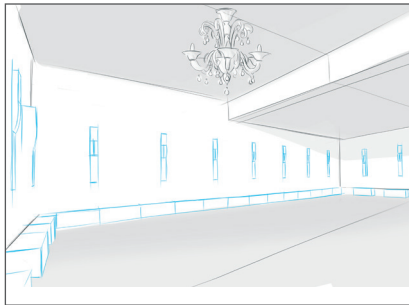

L-ISA Auditorium



Home Cinema

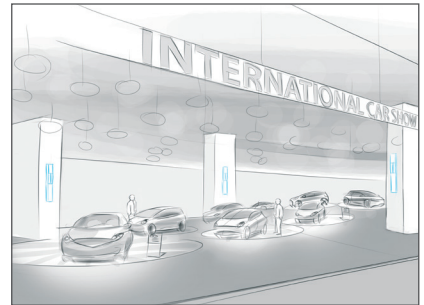

Trade Show

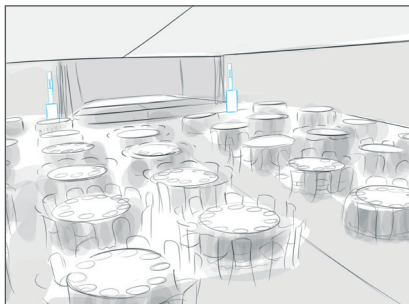

Corporate Event

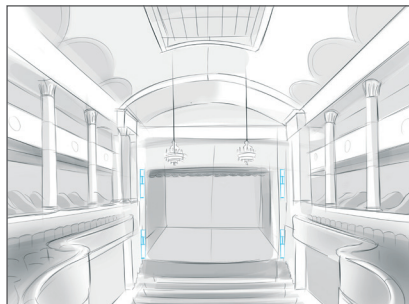

Performing Arts Center

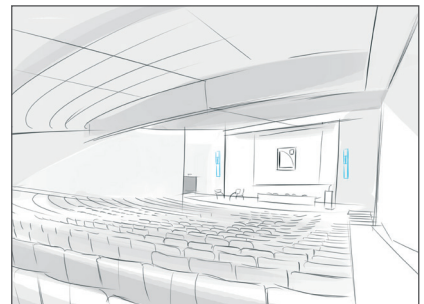

Amphitheatre

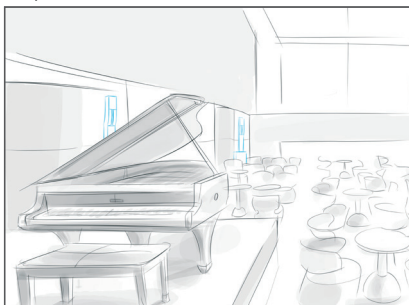

Lounge Bar

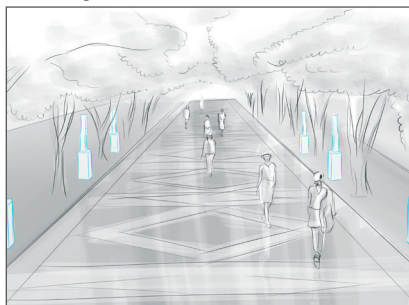

Fashion Show

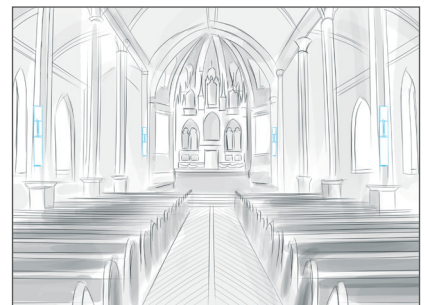

House of Worship

# RIGGING

Syva can be stacked as a standalone system or secured onto one of its LF extensions. Wall-mounting and flying are also possible.

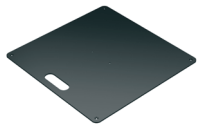

**Syva Base**  
Baseplate for  
Syva, Syva Low & Syva Sub

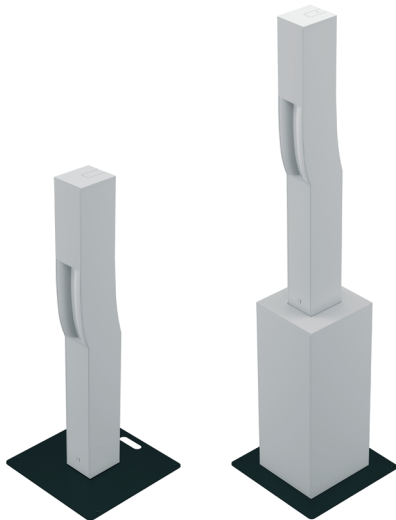

**Syva Wall**  
Wall-mount for Syva

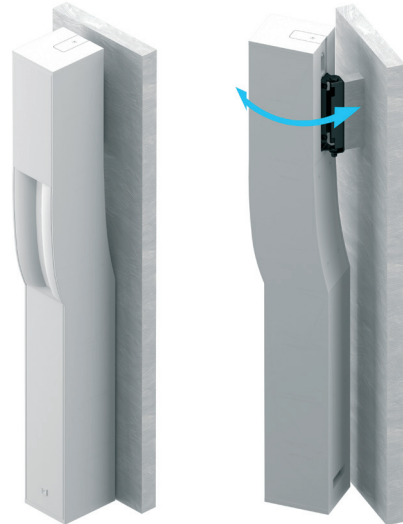

**Syva Pole**  
Pole-mount adapter for Syva

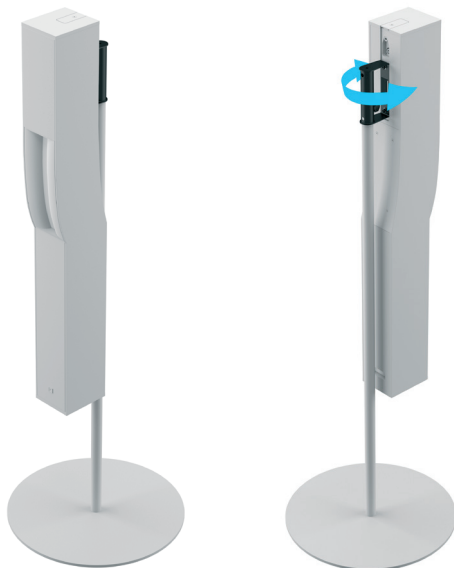

**Syva Bar**  
Rigging bar for Syva  
(combined here with Clamp250)

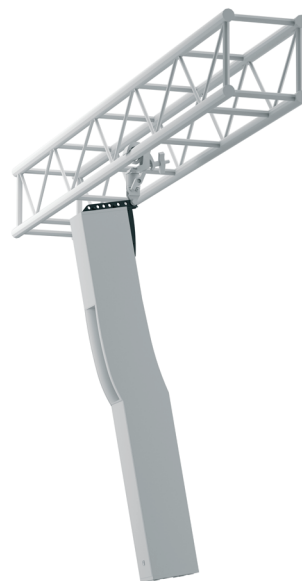

## AMPLIFIED CONTROLLERS

### LA4X: amplified controller with DSP

4 x 1000 W/8 ohms or 4 ohms  
 4 inputs x 4 outputs architecture  
 Max 4 enclosures per amplified controller



## SUBWOOFER

### Syva Low: high power subwoofer

System bandwidth: 40 Hz – 20 kHz  
 Ratio of 1 Syva Low to 1 Syva  
 Contour reinforced by 9 dB



### Syva Sub: infra subwoofer

System bandwidth: 27 Hz – 20 kHz  
 Ratio of 2 Syva Sub to 1 Syva Low and 1 Syva  
 Contour reinforced by 12 dB



## SOFTWARE

### Soundvision: simulation software



3D electro-acoustic & mechanical simulation software

### LA Network Manager: control & monitoring software



Real-time control and monitoring up to 253 units.  
 Multiple network topologies

# SPECIFICATIONS: SYVA

<b>Description</b>	2-way-passive enclosure, amplified by LA4X / LA8 / LA12X
<b>Usable bandwidth (-10 dB)</b>	87 Hz - 20 kHz ([SYVA])
<b>Maximum SPL<sup>1</sup></b>	137 dB ([SYVA])
<b>Nominal directivity</b>	Horizontal: 140° (>1 kHz) Vertical: +5/-21° in J shape (>1 kHz)
<b>Transducers</b>	MF: 6 x 5" HF: 3 x 1.75", compression driver
<b>Acoustical load</b>	MF: bass-reflex, L-Vents HF: DOSC, L-Fins
<b>Nominal impedance</b>	8 Ω
<b>Connectors</b>	IN: 2-point speakON® and screw terminal AutoConnect
<b>Rigging and handling</b>	DIN580 - compatible M8 threaded insert for secondary safety 2 integrated inserts for rigging accessory
<b>Weight (net)</b>	21 kg / 46 lb
<b>Cabinet</b>	First grade Baltic beech and birch plywood
<b>Front</b>	Steel grill with anti-corrosion coating Acoustically neutral 3D fabric
<b>Finish</b>	Fine grain dark grey brown Pantone 426C
<b>IP</b>	TBD

1- Peak level at 1 m under free field conditions using pink noise with crest factor 4 (preset specified in brackets).

## DIRECTIVITY/BEAMWIDTH

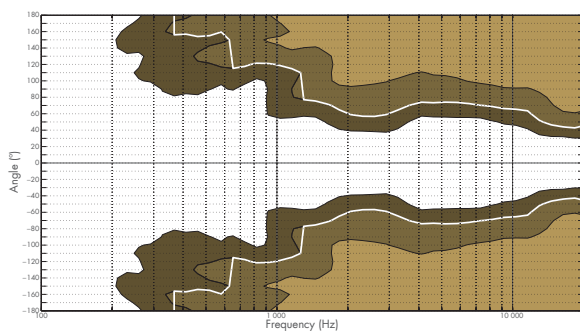

Beamwidth Syva horizontal 1/3 oct

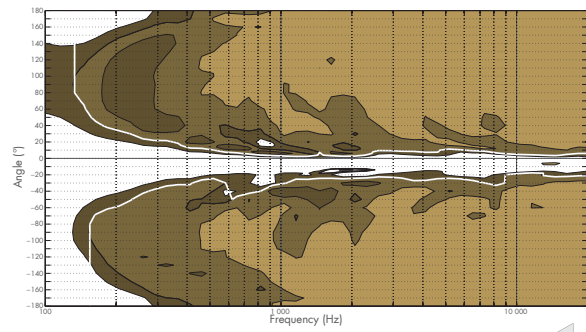

Beamwidth Syva vertical 1/3 oct



## DIMENSIONS

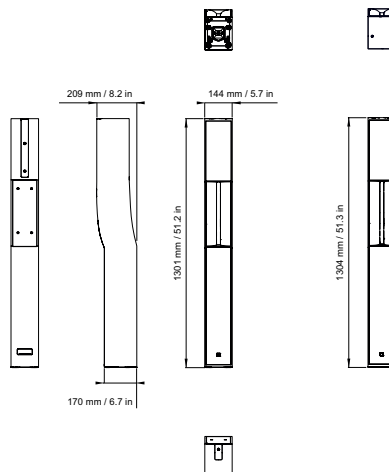

## SPECIFICATIONS: SYVA LOW

<b>Description</b>	High power subwoofer, amplified by LA4X / LA8 / LA12X
<b>Low frequency limit (-10 dB)</b>	40 Hz ([SYVA LOW_100])
<b>Maximum SPL<sup>1</sup></b>	137 dB ([SYVA LOW_100])
<b>Transducers</b>	LF: 2 × 12"
<b>Acoustical load</b>	Bass-reflex, L-Vents
<b>Nominal impedance</b>	4 Ω
<b>Connectors</b>	IN: 2-point speakON® AutoConnect
<b>Weight (net)</b>	29 kg / 64 lb
<b>Cabinet</b>	First grade Baltic beech and birch plywood
<b>Front</b>	Steel grill with anti-corrosion coating Acoustically neutral 3D fabric
<b>Finish</b>	Fine grain dark grey brown Pantone 426C
<b>IP</b>	TBD

1- Peak level at 1 m under half space conditions using pink noise with crest factor 4 (preset specified in brackets).

## SPECIFICATIONS: SYVA SUB

<b>Description</b>	Infra low frequency subwoofer, amplified by LA4X / LA8 / LA12X
<b>Low frequency limit (-10 dB)</b>	27 Hz ([SYVA SUB_100])
<b>Maximum SPL<sup>1</sup></b>	128 dB ([SYVA SUB_100])
<b>Transducers</b>	LF: 1 × 12"
<b>Acoustical load</b>	Bass-reflex, L-Vents
<b>Nominal impedance</b>	8 Ω
<b>Connectors</b>	IN: 2-point speakON® AutoConnect
<b>Weight (net)</b>	27 kg / 60 lb
<b>Cabinet</b>	First grade Baltic beech and birch plywood
<b>Front</b>	Steel grill with anti-corrosion coating Acoustically neutral 3D fabric
<b>Finish</b>	Fine grain dark grey brown Pantone 426C
<b>IP</b>	TBD

1- Peak level at 1 m under half space conditions using pink noise with crest factor 4 (preset specified in brackets).

## DIMENSIONS

