



Avid VENUE | S6L System Guide

and Avid VENUE | Software 6.1

Legal Notices

© 2019 Avid Technology, Inc., ("Avid"), all rights reserved. This guide may not be duplicated in whole or in part without the written consent of Avid.

For a current and complete list of Avid trademarks visit: <http://www.avid.com/legal/trademarks-and-other-notice>

Bonjour, the Bonjour logo, and the Bonjour symbol are trademarks of Apple Computer, Inc.

Thunderbolt and the Thunderbolt logo are trademarks of Intel Corporation in the U.S. and/or other countries.

This product may be protected by one or more U.S. and non-U.S. patents. Details are available at www.avid.com/patents.

Product features, specifications, system requirements, and availability are subject to change without notice.

Guide Part Number 9329-66014-00 REV A 02/19

Safety Compliance

Safety Statement: (M/N: S6L16, S6L24(all), S6L32, Local 16, Stage 16, Stage 32 and Stage 64)

This equipment has been tested to comply with USA and Canadian safety certification in accordance with the specifications of UL Standards: UL 60065 7th Ed., 2013-07-24, CAN/CSA C22.2 No. 60065-03, 1st Ed, +A1:2006 +A2:2012, EN 60065:2002 +A1:2006 +A11:2008 +A2:2010 +A12:2011, IEC 60065:2001 +A1:2005 +A2:2010.

Avid Technology Inc., has been authorized to apply the appropriate NRTL mark on its compliant equipment.

Safety Statement: (M/N: E6L(all))

This equipment has been tested to comply with USA and Canadian safety certification in accordance with the specifications of UL Standards: UL 60950-1 2nd edition, CAN/CSA C22.2 No. 60950-1-07; 2nd edition, EN 60950-1:2006 /A12:2011, IEC 60950-1:2005+ A1:2009 2nd edition.

Avid Technology Inc., has been authorized to apply the appropriate NRTL mark on its compliant equipment.

Power Safety Input Rating

S6L16: AC~100-240V, 50-60Hz, 4.0A per inlet
S6L24(all): AC~100-240V, 50-60Hz, 4.0A per inlet
S6L32: AC~100-240V, 50-60Hz, 5.0A per inlet
E6L(all): AC~100-240V, 50-60Hz, 5.0A per inlet
Local 16: AC~100-240V, 50-60Hz, 0.6A per inlet
Stage 16: AC~100-240V, 50-60Hz, 0.6A
Stage 32: AC~100-240V, 50-60Hz, 3.65A per inlet
Stage 64: AC~100-240V, 50-60Hz, 3.65A per inlet

Warning



Important Safety Instructions for E6L

- 1) User should make sure that all the thumb screws are secured by a tool.
- 2) The E6L system can hold the following cards:
 - (3) AVB Cards
 - (4) HDX Cards
 - (4) MADI-192 MADI Option Cards
 - (8) DIMMs of RAM.

User should not install additional cards.

Important Safety Instructions

- 1) Read these instructions.
- 2) Keep these instructions.
- 3) Heed all warnings.
- 4) Follow all instructions.
- 5) Do not use this equipment near water.
- 6) Clean only with dry cloth.
- 7) Do not block any ventilation openings. Install in accordance with the manufacturer's instructions.
- 8) Do not install near any heat sources such as radiators, heat registers, stoves, or other equipment (including amplifiers) that produce heat.
- 10) Protect power cords from being walked on or pinched particularly at plugs, convenience receptacles, and the point where they exit from the equipment.
- 11) Only use attachments/accessories specified by the manufacturer.
- 12) For products that are not rack-mountable: Use only with a cart, stand, tripod, bracket, or table specified by the manufacturer, or sold with the equipment. When a cart is used, use caution when moving the cart/equipment combination to avoid injury from tip-over.
- 13) Unplug this equipment during lightning storms or when unused for long periods of time.
- 14) Refer all servicing to qualified service personnel. Servicing is required when the equipment has been damaged in any way, such as power-supply cord or plug is damaged, liquid has been spilled or objects have fallen into the equipment, the equipment has been exposed to rain or moisture, does not operate normally, or has been dropped.
- 15) For products that are a Mains powered device:

The equipment shall not be exposed to dripping or splashing and no objects filled with liquids (such as vases) shall be placed on the equipment.



Warning! To reduce the risk of fire or electric shock, do not expose this equipment to rain or moisture.

Do not defeat the safety purpose of the polarized or grounding-type plug. A polarized plug has two blades with one wider than the other. A grounding type plug has two blades and a third grounding prong. The wide blade or the third prong are provided for your safety. If the provided plug does not fit into your outlet, consult an electrician for replacement of the obsolete outlet.

16) For products containing a lithium battery:



Warning! Danger of explosion if battery is incorrectly replaced. Replace only with the same or equivalent type.

17) For products with a power switch:

It should remain accessible after installation.

18) The equipment shall be used at a maximum ambient temperature of 40° C and maximum altitude of 2000m.

19) This unit may not ship with a power supply cord set. A qualified person must provide for use with this unit, an appropriate, approved power supply cord set which is in compliance with the end use country requirements and has a minimum cross-sectional area of 1.0mm².

20) For products with more than one power cord:

CAUTION: This unit has more than one power supply cord. Disconnect two power supply cords before servicing to avoid electrical shock.

ATTENTION: Cet appareil comporte plus d'un cordon d'alimentation. Afin de prévenir les chocs électriques, débrancher les deux cordons d'alimentation avant de faire le dépannage.

21) For products with an operator-accessible fuse:

CAUTION: For continued protection against risk of fire, replace only with same type and rating of fuse.

ATTENTION: Pour ne pas compromettre la protection contre les risques d'incendie, remplacer par un fusible de même type et de même caractéristiques nominales.

22) For products with Fiber optics:



Warning! Fiber optic equipment can emit laser or infrared light that can injure your eyes. Never look into an optical fiber or connector port. Always assume that fiber optic cables are connected to a light source.



Contents

Part I Overview

Introduction to the VENUE S6L System	1
Installation and Setup	1
S6L System Features	1
S6L Control Surface Features	2
E6L Engine Features	5
Stage 64 I/O Rack Features	6
Stage 32 I/O Rack Features	7
Stage 16 Remote IO Features	8
Local 16 I/O Features	9
What's Included	9
Expansion Options	10
Operational Requirements	11
Cabling Requirements	12
System Requirements and Compatibility	12
Resources	13
Activation	13
Conventions Used in This Guide	14
S6L Control Surface Overview	15
S6L Control Surface Top Panel Overview	15
Fader Banks	16
Channel Knob Modules (CKM)	21
Channel Touch Module (CTM)	26
Master Live Module (MLM)	28
Master Touch Screen (MTS)	37
S6L Control Surface Connections	42
E6L Engine Overview	46
E6L Cards and Features	46
E6L Front Panel	47
E6L Back Panel	48
Stage and Local I/O Rack Overview	50
Stage 64 and Stage 32 I/O Card Features and Capabilities	51
Stage 64 Front Panel	52
Making Stage I/O Unit Connections	54
Stage 64 Controller Display	54
Using MAD1 Outs on Stage 64 and Stage 32	59

Part II Using S6L

Configuring System Audio	61
Powering the System Up and Down	62
Confirming System Components	64
Pairing the E6L and S6L	65
Enabling Config Mode	67
Assigning Stage I/O Units	68
Assigning Local 16	71
Setting the System Clock	76
Configuring Mains and Mix Buses	77
Managing Connections	79
How to Proceed	83
Banking Channels on the S6L Control Surface	84
Channel Banking Overview	84
Banking a Combination of Inputs and Outputs	85
Banking Only User Layouts, VCAs, Inputs, or Outputs	88
Spill Mode for Outputs	89
User Layouts	90
Bank Safing Channels	97
Selecting and Attentioning Channels	100
Selecting Channels	100
Attentioning Channels	102
Attention on Fader	103
Selecting/Attentioning Multiple Channels (Multi-Select)	104
Adjusting Channel Parameters	106
Configuring and Patching Channels	106
Assigning Channels to Outputs	107
Assign VCAs and Mute Groups from Channel Control Encoders	109
Adjusting Input Parameters on the Control Surface	110
Adjusting EQ on the Control Surface	118
Adjusting Dynamics on the Control Surface	122
Adjusting Plug-Ins on the Control Surface	125
Using the CHANNEL Function	127
Flipping Parameters to Faders (Flip to Faders Mode)	128
Encoder Assign Mode	129
Working with Mains and VCAs	130
Working with Mains	130
Working with VCAs	134
Working with Aux Sends	137
Adjusting Aux Sends in Channel Control Mode	137
Adjusting Aux Sends in Channel Strip Mode	140
Adjusting Aux Sends on Faders (Sends on Faders Mode)	141

VCAs Trim Aux Sends in Sends on Faders Mode	144
Adjusting Aux Sends on the External Screen	145
Classifying Auxes for Snapshots	146
Matrix Mixers	147
Matrix Mixers Overview	147
Assigning Input Sources to Matrix Mixers	148
Adjusting Matrix Mixer Input Controls	149
Delay Compensation with Matrix Mixers	152
Adjusting Matrix Mixer Output Controls	152
Snapshot Data and Parameters for Matrix Mixers	153
Muting and Mute Groups	154
Muting Individual Channels	154
Mute Groups	156
Snapshot Data and Parameters for Mute	161
Soloing and the Monitor Buses	162
Configuring the Monitor Buses and Solo Options	162
Adjusting Monitor Buses	164
Soloing Channels	166
Using the Headphone Outputs	170
Part III External VENUE Software Screen	
External VENUE Software Screen Overview	172
Viewing Pages and Tabs	172
Overview of Software Pages	175
Banner Display	179
Type Text Search	180
Overview, Inputs, and Outputs Pages	181
Navigating the Overview, Inputs, Outputs Pages	181
Attentioning Channels from the External Screen	183
Adjusting Parameters on the External Screen	184
Working with EQ and Dynamics on the External Screen	186
Input Direct	190
Copying and Pasting Settings	191
Configuring Channels on the External Screen	193
Inserting Plug-Ins on Channels	197
Input Channel, EQ, and Dynamics Presets	198
Assigning Channels to Buses and VCAs on the External Screen	200
Managing Output Channel Assignments (Members)	201
Color-Coding Channels from the External Screen	202
Filing	203
Creating Shows	203
Loading a Show	205

Working with Presets	206
Transferring Settings, Shows and Presets	208
Import Snapshots and Events	210
Undoing Changes Using the History Feature	211
Snapshots	213
Snapshots Page Overview	214
Creating Snapshots	220
Hierarchical Snapshots (Parent and Child Snapshots)	221
Momentary Snapshots	224
Snapshot Groups	225
Recalling Snapshots	226
Managing Snapshots	230
Making Changes to Snapshots	233
Preview Mode	236
Adding MIDI and Plug-In Data to Snapshots	240
Snapshot Options	245
User Aux Scope	247
Recall Safe	252
Automation Safing Channels	258
Snapshot Data Types and Parameters	261
Patchbay	262
Accessing the Patchbay	262
Overview of the Patchbay	262
Patching Input Sources to Input Channels	265
Patching Output Channels to Hardware Outputs	266
Patching Direct Outputs	267
Unpatching and Clearing Assignments	268
Multiple Input and Output Patching	269
Warning When Stealing Inputs or Outputs in the Patchbay	270
Naming Channels from the Patchbay	270
Type Text Search	271
Patch List Export	271
Plug-Ins	272
Plug-Ins Quick Start	272
Installing and Authorizing Plug-Ins	273
Plug-in Version Checker	277
Plug-In Racks	278
Rack Slots	283
Routing Plug-Ins	286
Adjusting Plug-Ins on the External Screen	290
Plug-In Presets and Snapshots	291
Plug-In DSP Usage	292
Plug-In Levels	293
Plug-In Latency and Processing Delay	293
Initializing the Plug-In Racks	293

Tap Tempo for Plug-ins	294
WSG-HD Waves SoundGrid Option Card and Waves Plug-Ins	295
Events	302
The Events Tab	303
Creating Events	307
Events Presets	310
Creating Triggers	311
Creating Actions	315
Testing Events	317
Resetting Events	317
Snapshots and Events	318
Default Settings, Templates and Examples	319
Trigger Types	322
Action Types	324
Examples of Logical Operators	328
Options	329
System	329
Buses	333
Pickoffs	335
Snapshots	336
Misc	338
Interaction	342
Devices	346
Plug-Ins	349
Part IV Recording and Playback	
Pro Tools Recording and Playback	351
Pro Tools Compatibility	351
Part V Reference	
Synchronization	353
Clock Synchronization Overview	353
Time Code Overview	353
Synchronizing External Devices using Word Clock	354
Synchronizing using AES/ADAT or MADI Clock	357
Time Code	362
Connecting and Using the MADI-192 MADI Option Card	367
Making Audio Connections	367
Using MADI	368
Enabling Virtual Soundcheck Recording	369
Performing a Virtual Soundcheck using MADI-192	370
Enabling Redundant Outputs	371
Using MADI for Hardware Inserts	371

Hardware Inserts	372
Connecting External Hardware	372
Assigning Hardware Inserts to Channels	373
Activating and Bypassing Hardware Inserts	374
Setting the Hardware Insert Location	374
GPI Port Reference	375
GPI Input Specifications	375
GPI Output Specifications	376
GPI Wiring Diagrams	377
Troubleshooting	380
Problem Solving	380
Restarting Your System	384
Resetting Hardware Components	385
Resetting Channel Touch Modules (CTMs)	385
Offline or Unavailable Devices	386
Hardware Monitoring Window	387
E6L Engine Emergency Shutdown	387
Utility Mode	387
Resetting the Plug-In Racks	388
Using the System Restore Software	388
Updating HDX-192 DSP Card Firmware	389
Updating MADi Card Firmware	389
Configuring S6L Master Touch Screen (MTS) and External Monitor	390
LED Brightness	391

Part VI Specifications

Mechanical Specifications	393
S6L-16C Control Surface	393
S6L-24C Control Surface	394
S6L-24/24D Control Surface	395
S6L-32D Control Surface	396
E6L Engine	397
Stage 64	398
Stage 32	399
Stage 16	400
Local 16 I/O	401
S6L System Components LED Codes	402
Replacing S6L and E6L PSUs	403
S6L Secure USB Port	404
Making Fiber-Optic Connections	405
Audio Specifications	406
Signal Flow Diagrams	410
Input Channel Signal Flow	410

Output Channel Signal Flow 411

Part VII Appendices

Environmental Compliance 413

EMC (Electromagnetic Compliance) 413

Index 414

Part I: Overview

Introduction to the VENUE | S6L System

Welcome to the VENUE | S6L digital live mixing system from Avid®. The S6L system includes the VENUE | S6L control surface, the VENUE | E6L engine, up to six supported Stage I/O units: VENUE | Stage 64 I/O, VENUE | Stage 32 I/O, or VENUE | Stage 16 I/O, and up to two Local 16 I/O units. Together, these components provide a modular, scalable, and high-fidelity live mixing solution using ultra-reliable and low-latency Ethernet AVB audio network connections.

The S6L-32D, 24D, and 24C control surfaces feature high-resolution touch screens and channel displays, providing unmatched visual feedback and tactile control. The S6L system also uses the same intuitive and powerful VENUE software used by all other systems in the Avid live systems family, providing Show file portability between Avid live systems. Other features include direct Pro Tools® connectivity and interoperability, support for AAX DSP plug-ins from Avid and our many development partners.

Remote control is available using Avid VENUE | On-Stage app, VENUE Function Pad app, and ECx Ethernet Control software.

Avid VENUE | On-Stage app for iOS lets performing artists remotely control their personal mix with access to Aux master level, and level and pan of each member channel feeding a selected Aux monitor mix. VENUE | On-Stage can also adjust Mains level, with control of channel level, pan (for mono), or balance and width (for stereo), and mute for each channel assigned to Mains. Access to mixes can be password protected. For more information, see the *VENUE On-Stage Guide.pdf*.

Avid VENUE | Function app For iOS, lets engineers remotely access Function switch assignments defined via the Events page, such as being able to remotely control the Pro Tools transport to cue and play back material while checking on-stage monitor mixes. For more information, see the *VENUE Function Pad Guide.pdf*.

ECx Ethernet Control lets you remotely control your system over a wired or wireless Ethernet network. For more information see the *ECx Ethernet Control Guide*.

Installation and Setup

For complete hardware and software installation instructions, see the *VENUE S6L Installation Guide.pdf*, available for download from your [Avid account](#) and from the [S6L Documentation](#) article on our Knowledge Base.

After activating, updating, and setting up your system, return to this guide for S6L features, capabilities, and operating information.

S6L System Features

S6L System Processing

- Up to 192 input processing channels, each with built-in High- and Low-Pass Filters, Dynamics and 4-band fully parametric EQ processors
- Up to 123 output processing channels, each with a built-in Compressor/Limiter and 7-band fully parametric EQ
- 32 assignable 31-band Graphic EQs
- Up to 99 mix buses total (96 mix buses plus Main L-R, C/Mono), up to 24 mono stereo-linkable Matrixes, and up to 32 VCAs
- Up to 200 plug-in rack slots for VENUE-compatible 64-bit AAX DSP plug-ins

S6L System Recording and Playback Features

- 128 channels of recording and playback (64 in x 64 out) with a compatible Pro Tools system, including true Virtual Sound-check capability. Or with two compatible Pro Tools systems, one recorder (up to 128 channels) and one record/playback system.
- VENUE Link, providing Pro Tools and VENUE interoperability and interconnection, including Pro Tools Transport control from the S6L control surface
- Dual MADI splits of Stage inputs on a per Stage 64 and/or Stage 32 basis



For complete system requirements and a list of qualified computers, operating systems, and third-party devices, visit www.avid.com/S6Lsupport.

S6L Control Surface Features

The S6L control surface provides system controls, mix position audio I/O, and control and utility connections. The S6L control surface is available in three models, the S6L-32D, S6L-24D, and the S6L-24C, which provide the following features and capabilities:

	S6L-32D	S6L-24D	S6L-24C	S6L-16C
Integrated Touch Screens	1 Master Touch Screen, 3 Channel Touch Modules	1 Master Touch Screen, 2 Channel Touch Modules	1 Master Touch Screen	n/a
Faders	32 channel strips + 2	24 channel strips + 2	24 channel strips + 2	16 channel strips + 2
Channel Knob Modules (CKM)	3 CKMs, each with 32 color-coded encoders, 32 high-resolution displays, and tri-color indicators	2 CKMs, each with 32 color-coded encoders, 32 high-resolution displays, and tri-color indicators	1 CKM with 32 color-coded encoders, 32 high-resolution displays, and tri-color indicators	1 CKM with 32 color-coded encoders, 32 high-resolution displays, and tri-color indicators
Master Live Module	2 TFT displays with Soft Keys; Touch and Turn assignable encoder; 2 assignable faders; monitoring, layout and snapshot controls; transport controls and function buttons			
Metering	30-segment meters per channel, with pre- and post-fade metering options; Nominal indicator, Expander/Gate status and Compressor/Limiter gain reduction meters			
Analog inputs	8 XLR mic/line inputs with 48V and signal present LEDs			1 XLR mic/line input
Analog outputs	8 XLR outputs with mute and signal present LEDs			2 XLR outputs
Digital inputs	4 pairs of XLR stereo AES/EBU (8 channels total)			n/a
Digital outputs	4 pairs of XLR stereo AES/EBU (8 channels total)			n/a
Headphone outputs	2 independent 1/4-inch TRS stereo headphone jacks			1 1/4-inch TRS stereo headphone jack
Ancillary I/O	DVI-D video out, 4 USB 2.0 (2 rear, 1 front, 1 internal), ECx Ethernet port for wired/wireless remote control, GPIO (8 in/8 out), 2 footswitch, Linear Time Code input, MIDI I/O			
AVB Audio Network ports	4, each providing etherCON (copper) or SFP (fiber optic) connections			
Power supply	2 (1+1) redundant, internal hot-swappable PSUs		Dual redundant, internal	

S6L-32D



VENUE | S6L-32D

S6L-24D



VENUE | S6L-24D

S6L-24C



VENUE | S6L-24C

S6L-16C



VENUE | S6L-16C

Lights (S6L-24C and S6L-16C)

The S6L-24C provides 2x connectors (3-pin XLR) on the top panel for connecting goose-neck LED console lamps. Note that only LED lights are supported on the S6L-24C. S6L-32D and S6L-24D control surfaces provide a built-in Light Bar to illuminate the surface.

E6L Engine Features

The E6L engine provides the real-time processing engine for input and output channels, and Pro Tools | HDX DSP processing card(s) for AAX DSP plug-ins. The E6L engine also provides connections for synchronization, control and utility in a 5U rack-mountable enclosure. The E6L-192, E6L-144, and the E6L-112 provide the following features and capabilities in their basic configuration:

	E6L-192	E6L-144	E6L-112
Sample rates	96 kHz	96 kHz	96 kHz
Input channels	192	144	112
Input processing (per channel)	HPF, LPF, 4-band PEQ, Expander/Gate, Compressor/Limiter, Delay, 4 plug-in inserts, hardware insert		
Mix buses	96 + L-R, C/Mono	64 + L-R, C/Mono	48 + L-R, C/Mono
Output processing (per channel)	7-band PEQ, Compressor/Limiter, Delay, 4 plug-in inserts, hardware inserts		
Matrix	24 x 24	16 x 16	16 x 16
VCA's	32	24	24
Monitor buses	2 stereo, each with independent control and routing		
Graphic EQs (31-band)	32		
Plug-in support	1 x HDX-192 DSP card, expandable to up to four HDX cards	1 x HDX-192 DSP card, expandable to up to two HDX cards	1 x HDX-192 DSP card, expandable up to two HDX cards
Plug-in slots	200	125	100
Pro Tools Recording/Playback	Record/play back up to 128 audio tracks via Ethernet AVB		
AVB Audio Network Ports	2, each providing etherCON (copper) or SFP (fiber optic) connections (Some base configurations with Stage 16s include an additional AVB-192 card)		
I/O Sharing	Supports combinations of Stage 64, Stage 32s, and Stage 16 racks, up to 192 inputs total (requires two AVB-192 Ethernet AVB Network Cards to share I/O)		
Word Clock I/O	Input and Output, BNC, 75 Ohm coaxial		
USB ports	4 USB 2.0 ports (2 front, 2 back)		
Power supply	3 (2+1) redundant, internal hot-swappable PSUs		Dual redundant, internal
Rack spaces	5U		



VENUE E6L

Stage 64 I/O Rack Features

Stage 64 provides remote stage I/O for S6L systems in a 10U rack-mountable enclosure. The S6L system supports redundant audio network connections to up to three Stage 64 I/O racks. Audio network connections are made using supported copper Ethernet cables and/or fiber-optic cables (see [Audio Network Connections](#)).

I/O Rack	Stage 64
Maximum I/O	64 input channels, 32 output channels
I/O card slots	12 (8 for input cards, 4 for output cards)
Sample rates	96 kHz
AVB Audio Network Ports	2, each providing etherCON (copper) or SFP (fiber optic) connections
Maximum cable length	Copper: 100 meters (328 feet); Fiber: 500 meters (1,640.4 feet)
MADI Outs	2 BNC; digital split outputs of Stage 64 inputs at 48 or 96 kHz; supports 64 channel MADI formats
Headphone confidence monitor	1/4-inch TRS stereo headphone jack with volume control; display for channel selection
Word Clock Out	BNC, 75 Ohm coaxial
Power supply	Dual redundant internal PSUs
Rack spaces	10U



Stage 64 I/O Rack front panel (48 x 8 configuration shown)

Stage 32 I/O Rack Features

Stage 32 provides remote stage I/O for S6L systems in a 5U rack-mountable enclosure. Up to four Stage 32 units can be connected on supported systems. Audio snake connection are made using supported Ethernet cables (see [Audio Network Connections](#)).

 *Stage 32 requires 2x AVB-192 Network Cards in the E6L engine.*



Stage 32 I/O

The following table lists Stage 32 features and specifications:

I/O Rack	Stage 32
Maximum I/O	32 input/output channels @ 96 kHz with one Stage 32 rack
I/O card slots	4
Sample rates	96 kHz
AVB Audio Network Ports	2, each providing etherCON (copper) or SFP (fiber optic) connections
Maximum cable length	Copper: 100 meters (328 feet); Fiber: 500 meters (1,640.4 feet) for Multi-Mode, 10,000 meters for Single Mode Fiber
MADI Outs	Single MADI output offers direct split of up to 32 inputs
Headphone confidence monitor	n/a
Word Clock Out	n/a
Power supply	Dual redundant internal PSUs
Rack spaces	5U

Stage 16 Remote IO Features

Stage 16 provides remote stage I/O for S6L systems in a 4U rack-mountable enclosure. Up to four Stage 16 boxes can be connected on supported systems. Audio snake connection are made using supported Ethernet cables (see [Audio Network Connections](#)).

 *Stage 16 requires 2x AVB-192 Network Cards in the E6L engine.*

I/O Rack	Stage 16
Maximum I/O	16 analog input channels, 8 analog output channels, 4 AES digital output channels (on two stereo connectors)
Sample rates	96 kHz (with S6L systems), 48 kHz (with S3L-X/S3L systems)
AVB Audio Network Ports	2 Neutrik etherCON RJ-45 Ethernet Network ports
Maximum cable length	100 meters (328 feet)
Power supply	Internal universal PSU (100V to 240V nominal 50–60 Hz) accepting standard IEC AC power cables
Rack spaces	4U



Local 16 I/O Features

Local 16 lets you expand your local I/O capabilities—or add primary local I/O if mixing on the S6L-16C control surface—with this compact I/O rack. Features include:

- 8 XLR mic/line inputs, 8 XLR outputs, 4 pairs of XLR stereo AES/EBU inputs (8 channels total), 4 pairs of XLR stereo AES/EBU outputs (8 channels total)
- 3U rack
- Up to two Local 16 units can be connected on the local (console) S6L AVB Network ring when using S6L-16C. A single Local 16 can be used with other S6L systems.
- Audio network connections are made using supported copper Ethernet cables and/or fiber-optic cables
- Local 16 connects to the control surface network ring (Ring 2)

 *Local 16 requires 2x AVB-192 Network Cards in the E6L engine.*

The following table lists Local 16 features and specifications:

I/O Rack	Local 16
Maximum I/O	8 XLR mic/line inputs, 8 XLR outputs, 4 pairs of XLR stereo AES/EBU inputs (8 channels total), 4 pairs of XLR stereo AES/EBU outputs (8 channels total) @ 96 kHz with one Local 16 rack
I/O card slots	n/a
Sample rates	96 kHz
AVB Audio Network Ports	2, each providing etherCON (copper) or SFP (fiber optic) connections
Maximum cable length	Copper: 100 meters (328 feet); Fiber: 500 meters (1,640.4 feet) for Multi-Mode, 10,000 meters for Single Mode Fiber
MADI Outs	n/a
Headphone confidence monitor	n/a
Word Clock Out	n/a
Power supply	Dual redundant internal PSUs
Rack spaces	3U



Local 16 I/O

What's Included

See the *VENUE S6L Installation Guide.pdf* for a complete list of what's included with each system, additional required items (required but not included), and optional items.

Expansion Options

S6L systems can be expanded to add analog or digital IO, plug-in processing capability, and connectivity by adding any of the following options.

Stage 64 Expansion

You can expand the number of input and output channels by adding any of the following cards to a Stage 64, up to the maximum of 8 input cards and 4 output cards:

[SRI-192 Analog Input Card](#)

[SRO-192 Analog Output Card](#)

[DSI-192 Digital Input Card](#)

[DSO-192 Digital Output Card](#)

[DNT-192 Network Card](#)

Up to three Stage 64s can be connected simultaneously (requires dual AVB-192 Network Cards in the E6L Engine). For requirements and connection diagrams see the *VENUE S6L Installation Guide.pdf*.

Stage 32

Stage 32 lets you connect up to 32 analog, digital, and/or Dante inputs and outputs in a rack that offers maximum I/O flexibility in a smaller footprint for stage or remote I/O needs. Each Stage 32 supports up to a maximum 32 channels of inputs or outputs or a combination of both. You can customize Stage 32 with any of the same analog I/O, digital I/O, and Dante card options available for Stage 64, including SRI-192 Analog Input cards, SRO-192 Analog Output cards, DSI-192 Digital Input cards, DSO-192 Digital Output cards, and DNT-192 Dante Option cards.

Up to four Stage 32 units can be networked at once (requires dual AVB-192 Network Cards in the E6L engine), and you can combine Stage 32 with other VENUE S6L I/O units up to the maximum capacity of your system configuration. For requirements and connection diagrams see the *VENUE S6L Installation Guide.pdf*.

Stage 16

Stage 16s can be integrated into S6L systems (requires dual AVB-192 Network Cards in the E6L Engine). For supported configurations, requirements, and connection diagrams see the *VENUE S6L Installation Guide.pdf*.

Local 16

Local 16 can be integrated into S6L systems (requires dual AVB-192 Network Cards in the E6L Engine). Up to two Local 16s can be used with S6L-16C; other systems support one Local 16.

E6L Expansion

You can expand processing, connectivity, and IO capabilities by adding any of the following cards to an E6L engine.

- [HDX-192 DSP Expansion Cards](#)
- [AVB-192 Network Card](#)
- [MADI-192 MADI Option Card](#)
- [WSG-HD Waves SoundGridOption Cards](#)

S6L Control Surface Expansion

S6L-24 systems can be upgraded to S6L-24D by adding Channel Touch Modules. Contact your VENUE reseller for more information.

Operational Requirements

Temperature and Ventilation

S6L system devices should be operated away from heat sources and with adequate ventilation.



Hardware monitoring and automatic warnings are provided for temperature, power and other factors. For more information, see [Hardware Monitoring Window](#).

Storage

S6L system devices should be stored and transported at temperatures not lower than 0 degrees F (–18 degrees C) and not exceeding 140 degrees F (60 degrees C).

Operation

S6L system devices should be operated at temperatures not lower than 40 degrees F (4 degrees C) and not exceeding 104 degrees F (40 degrees C).

During operation, the left and right end caps on the back of the S6L control surface, the front and back of the E6L engine, and the fans on the back of the Stage 64 should be exposed to ambient air. Do not block the ventilation holes on any S6L system component.

Do not operate in direct sunlight or at extreme ambient temperatures.

Water and Moisture

S6L system devices should be operated away from sources of direct moisture and should be kept clear of liquids that might spill into the units. If condensation is present on the unit, leave the unit to dry in ambient air for at least one hour before powering the unit on.

Storage humidity range	5% to 95%, non-condensing
Operating humidity range	20% to 80%, non-condensing

Cleaning and Maintenance

- ◆ Use a dry cloth to clean the surfaces of the S6L components. Do not apply any cleaning solutions, spray cleaners, or abrasives to the surfaces of the components.
- ◆ Use a microfiber cloth (included with the S6L control surface) to clean the touch screens. Do not apply any cleaning solutions, spray cleaners, or abrasives.

Cabling Requirements

Power Connections

Power connections on all S6L system devices are auto voltage-selecting (100 to 240V nominal, 90-260V maximal, 50–60 Hz).

Make sure your power source is correctly rated for the number of units you are connecting. A surge-protected power source (not included) is highly recommended.

Audio Network Connections

This section describes the audio network cabling requirements for S6L system components. Audio network connections between S6L system components can be made using either copper or fiber-optic audio network cables. Cable types can be mixed within a system, but only one type of connection (copper or fiber) can be used per audio network connection.

 For complete information on connecting S6L system components, see the *VENUE S6L Installation Guide.pdf*.

Copper

Shielded Cat 5e (350 MHz) or better Ethernet cable with Neutrik etherCON connectors are required, supporting a distance of up to 100 meters per connection.

Fiber-Optic

S6L systems support single-mode fiber (SMF) or multi-mode fiber (MMF) cable to make audio network connections between components, as follows:

SMF Requires single-mode 9/125 OS1 or OS2 cables with duplex LC connectors and two qualified single-mode SFP transceivers per connection, supporting distances of up to 10 kilometers

MMF Requires multi-mode 50/125 OM2 or better cables with duplex LC connectors and two qualified multi-mode SFP transceiver modules per connection, supporting distances of up to 500 meters.

 Visit www.avid.com/S6Lsupport for a list of qualified SFP transceivers for use with S6L systems.

Pro Tools Connections

Shielded Cat 5e (350 MHz) or better Ethernet cable with RJ-45 connectors is required for the AVB audio connections to Pro Tools.

ECx Ethernet Control Connections

Standard Cat 5e Ethernet cable with RJ-45 connectors are supported for ECx remote control connections to a client computer or wireless/wired router.

System Requirements and Compatibility

Avid can only assure compatibility and provide support for hardware and software it has tested and approved. For complete system requirements and a list of qualified computers, operating systems, hard drives, and third-party devices, visit:

www.avid.com/S6Lsupport

Resources

The Avid website (www.avid.com) is your best online source for information to help you get the most out of your Avid system. The following are just a few of the services and features available.

Account Activation and Product Registration

Activate your product to access downloads in your Avid account (or create an account if you don't have one). Register your purchase online, download software, updates, documentation, and other resources.

<https://www.avid.com/account>

Support and Downloads

Contact Avid Customer Success (technical support); download software updates and the latest online manuals; browse the Compatibility documents for system requirements; search the online Knowledge Base or join the worldwide Avid user community on the User Conference.

<https://www.avid.com/Support/index.html>

For S6L system-specific support, visit:

www.avid.com/S6Lsupport

Get started learning the ins and outs of S6L using the many [Avid Live Sound](#) videos on YouTube.

Training and Education

Study on your own using courses available online, find out how you can learn in a classroom setting at an Avid-certified training center, or view a webinar. For example, check out the live sound webinars hosted by Robert Scovill:

<https://www.avid.com/resources/live-sound-webinar-registration>

Products and Developers

Learn about Avid products; download demo software or learn about our Development Partners and their plug-ins, applications, and hardware.

<https://www.avid.com/Products/index.html>

Activation

You must activate each S6L system component using the Activation Card included in each component's shipping package. Activating your product lets you receive the following:

- VENUE system software and plug-ins
- Technical support
- Software update and upgrade notices
- Hardware warranty information

Conventions Used in This Guide

All of our guides use the following conventions to indicate touch screen gestures and key commands:

Convention	Action
Touch	Touch an element on-screen briefly and immediately release your finger. Used to activate a function or toggle a parameter value.
Swipe	Touch an area on-screen and drag left/right/up/down. Used to scroll elements, where available.
Touch, Hold, and Drag/Slide	On the external VENUE software screen, touch and hold a parameter, then slide your finger to adjust parameters on-screen, or to drag elements.
Touch-and-Hold	On the external VENUE software screen, touching and holding an element on-screen, then releasing lets you access pop-up menu options, where available.
Double-Tap	Quickly tap an on-screen element such as a name field to edit its name
Options > System	On the external VENUE software screen, touch Options, then touch the System tab to display the System page.
Shift-touch/Ctrl-touch/Alt-touch	On the external VENUE software screen, press and hold Shift (or other keyboard modifier) on the keyboard, then touch an on-screen parameter.

The names of selectable on-screen elements that contain text are displayed in a different font.

The names of physical switches on the S6L control surface are in displayed **in bold text**.

The following symbols are used to highlight important information:

 *User Tips are helpful hints for getting the most from your system.*

 *Important Notices include information that could affect your data or the performance of your system.*

 *Shortcuts show you useful keyboard or mouse shortcuts.*

 *Cross References point to related sections in this guide and other VENUE guides.*

When Using a Mouse with S6L

For the best experience, Avid recommends you use qualified external monitors with touchscreen capabilities for accessing the external VENUE software screen. When discussing on-screen selections, “touch” is used. If you are using a mouse to control the external VENUE software screen, “touch” is synonymous with “click,” “touch-and-hold” is synonymous with “right-click,” “double-tap” is synonymous with “double-click” and “touch, hold and slide” is synonymous with “click-and-drag.”

How to Use this PDF Guide

This PDF provides the following useful features:

- The Bookmarks on the left serve as a continuously visible table of contents. Click on a subject heading to jump to that page.
- Click a + symbol to expand that heading to show subheadings. Click the – symbol to collapse a subheading.
- The Table of Contents provides active links to their pages. Select the hand cursor, allow it to hover over the heading until it turns into a finger. Then click to locate to that subject and page.
- All cross references in **blue** are active links. Click to follow the reference.
- Select Find from the Edit menu to search for a subject.
- When viewing this PDF on an iPad, it is recommended that you open the file using iBooks to take advantage of active links within the document. When viewing the PDF in Safari, touch the screen, then touch Open in “iBooks”

S6L Control Surface Overview

The section provides an overview of S6L control surface controls, and front and back panel audio, control, and power connections.

S6L Control Surface Top Panel Overview

The S6L control surface is available in four models, S6L-32D, S6L-24D, S6L-24C, and S6L-16C. Most available controls are common across all models, and only vary in quantity between models. Unlike other control surfaces, the S6L-16C does not include a Master Touch Screen (use the external screen instead).

S6L is oriented vertically. On S6L-32D and 24D, each fader bank (except the fader bank under the Master Live Module) is operationally associated with the Channel Knob Module and the Channel Touch Module (if present) above it. All three operate in unison: bank channels to a fader bank, select a banked channel, adjust that channel's parameters on the associated Channel Knob Module, and view the banked channels' parameters on the associated Channel Touch Module. On S6L-24C and S6L-16C, the single Channel Knob module provides access to the currently banked or selected channel. You can also select a channel from a Channel Touch Module (if present) and adjust its parameters on the associated Channel Knob Module.

The Master Live Module provides control over global system parameters such as channel banking, snapshots and monitoring. The Master Touch Screen, above the Master Live Module on S6L-32D and 24D and in the center on 24C, provides access to all system channels (via Universe view), to parameters for the currently Attentioned channel (via Channel view), and a local view of the channels banked to the faders below the Master Live Module (via Meters view). S6L-16C does not include a Master Touch Screen but provide connection, configuration, and Universe views on the external screen instead.

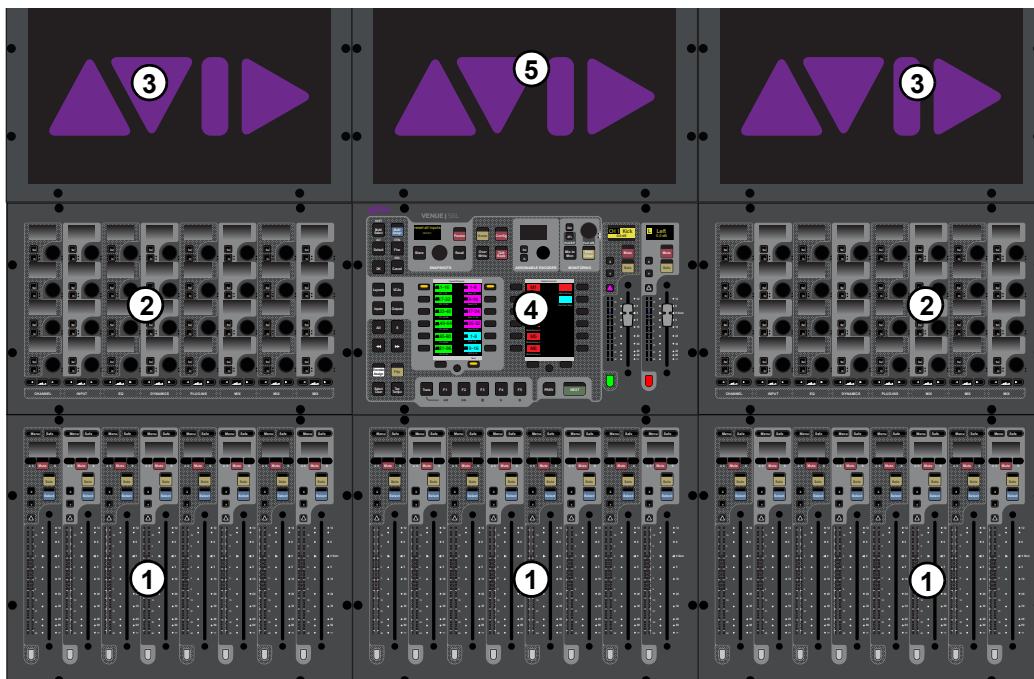

S6L top panel (S6L-24D shown)

- 1 – Fader Banks
- 2 – Channel Knob Modules (CKM)
- 3 – Channel Touch Module (CTM)
- 4 – Master Live Module (MLM)
- 5 – Master Touch Screen (MTS)

Fader Banks

Each fader bank provides eight channel strips to control input or output channels, depending on the type of channels banked to the faders. Each channel strip provides the following controls and indicators:

- 1 – Channel Menu
- 2 – Channel Safe
- 3 – Channel Display
- 4 – Mute
- 5 – Solo
- 6 – Select
- 7 – Attention
- 8 – X and Y Switches
- 9 – Channel and Gain Reduction Meters
- 10 – Fader
- 11 – Channel Color Switch

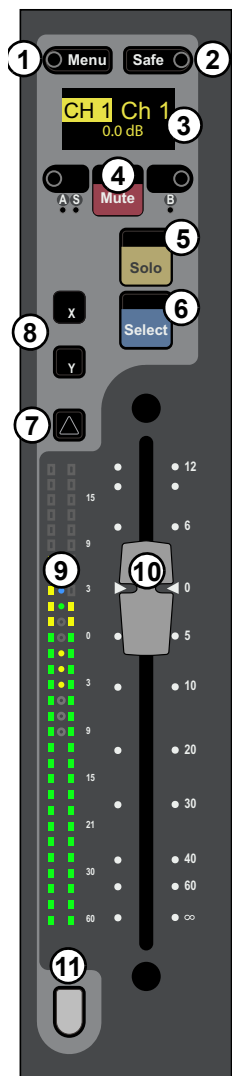

Channel Menu

The Channel Menu provides several pages of parameters that apply to the banked channel. The **Menu** switch (“1” in the figure below) enables the Channel Menu, which is shown in the channel display. The Left and Right Menu switches (2 and 3 in the figure below) toggle the currently displayed Channel Menu parameter.

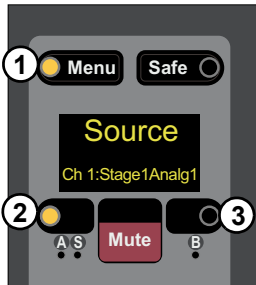

S6L Channel Menu

To use the Channel Menu:

- 1 Press **Menu** so it lights. The first page of the Channel Menu appears in the channel display.
- 2 Press **Menu** again to cycle through the available pages of Channel Menu options.
- 3 To toggle the parameter currently shown in the channel display, press the Left and Right Menu switches, as available. Each Menu switch has an LED that lights when the associated parameter is enabled.

The following table provides a description of each Channel Menu page and the function of the Left and Right Menu switches for each page:

Channel Menu Page	Parameter	Left Menu Switch	Right Menu Switch
Source/Destination	For an input channel, show and toggle channel source. For an output channel, show channel destination.	For input channels, enables the hardware input patched to the channel in the Patchbay as the source	For input channels, enables the corresponding Pro Tools Virtual Soundcheck input as the source for the channel
Monitor	Show and route channel Solo to Monitor bus A and/or B.	Routes the channel Solo to Monitor Bus A*	Routes the channel's Solo to Monitor Bus B*
Safe Mode	Engage a Safe mode not targeted as the global safe mode.	Engages Safe (automation, solo or bank)	Engages Safe (automation, solo or bank)

* By default, channel Solo is routed to Monitor bus A. When Monitor A and B are selected, the channel is assigned to both Monitor buses, both Menu switch LEDs are lit and “Mon A+B” appears in the Channel Menu Monitor page. For more information, see [Routing Channels to the Monitor Buses](#).

Channel Safe

Each channel strip provides a dedicated Channel Safe switch that lets you Automation, Solo (input channels only), or Bank Safe the currently banked channel. The Safe mode engaged by the Channel Safe switch is defined globally for input and output channels in the Channel Safe Switches section of the Options > Interaction page of the external screen, (see [Interaction](#) for more information).

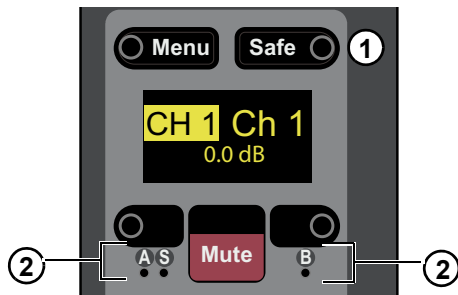

S6L Channel Menu controls

The channel strip provides the following Channel Safe controls and indicators:

1 – Safe

The **Safe** switch toggles safe on the channel.

2 – Safe LEDs

These LEDs light to indicate channel safe status, as follows:

- When **A** lights green, Automation Safe is enabled.
- When **S** lights yellow, Solo Safe is enabled.
- When **B** lights green, Bank Safe is enabled.

 You can also safe channels using the Channel Knob Modules (CKM) and the Channel Menu. For more information see [Managing Snapshots](#), [Bank Safing Channels](#) and [Solo Safing Channels](#).

Channel Display

The channel display shows information for the currently banked channel such as the channel number and/or name, the current level in dB for the banked channel, hardware assignment and current fader value, or a [Channel Menu](#) page if **Menu** is engaged.

 Channel Displays can be optimized for easier viewing of channel name using the [Use Simple OLEDs](#) setting.

Mute

Mute explicitly mutes the channel, removing the channel's audio signal from any post-mute audio path, including L-R, C/Mono buses, Groups, post-fader Direct Outs, and any post fader Aux sends, and lights solid red when engaged.

 A channel can be implicitly muted, for example, when it is muted as part of a Mute Group or VCA. See [Muting and Mute Groups](#) for more information. When a channel is implicitly muted, the Mute switch flashes red. Pressing **Mute** when a channel is implicitly muted toggles the channel into or out of mute.

Solo

Solo sends the channel's audio signal to the Monitor buses (when in AFL or PFL solo mode) or mutes all un-soloed input channels (when in SIP solo mode). The S6L system provides two discrete Monitor buses, which can be configured to feed either or both headphone outputs, and any number of system hardware outputs. See [Soloing and the Monitor Buses](#) for more information.

Select

Select selects a channel *locally*, targeting the channel for processing using the 32 encoders on the associated Channel Knob Module (CKM). From the CKM you can access channel processing functions such as EQ and dynamics via Channel Control mode (see [Channel Control Mode](#) for more information).

Select also highlights that channel on any associated Channel Touch Module (CTM)—the screen in line with the fader bank from which you selected the channel (only available on S6L-32D and 24D). You can select multiple channels for batch processing (Multi Select). You can also deselect a channel, which enables Channel Strip mode on the associated CKM (see [Channel Strip Mode](#) for more information).



Selecting a channel banked to the fader bank below the Master Live Module targets the channel to the rightmost CKM and CTM.

S6L-24C/16C and Local Select

On the S6L-24C and S6L-16C, pressing **Select** on any strip focuses that channel on the CKM. In addition:

- When any Channel is selected, the MTS enters Channel View for the selected channel.
- When no Channel is selected, the CKM is in Vertical mode for the faders directly below the CKM.
- If a Channel is selected but no parameter type was previously selected, the Channel parameters are displayed on the CKM.

Attention

Attention attentions a channel *globally*, targeting the channel to the Master Touch Screen (MTS) and by default to Flex Channel A on the Master Live Module (see [Flex Channels](#) for more information). Attention lets you focus on an important channel on the MTS and a Flex Channel, keeping it visible and accessible at all times, while still allowing you to select other channels from the fader banks (using **Select**) and adjust their parameters on their respective CKMs and CTMs, if any.

Attention also targets the respective channel on the external screen, from which you can view and adjust the attentioned channel's parameters. You can also select multiple channels using **Attention** and apply an action to all selected channels at once, such as applying a high-pass filter to multiple channels at the same time (Multi-Select).



You can also attention channels by touching a channel tile on Master Touch Screen (MTS). See [Master Touch Screen \(MTS\)](#) for more information.



For more information on selecting and attentioning channels, see [Selecting Channels](#).

X and Y Switches

The X and Y switches provide convenient single-switch controls for the associated channel's built-in dynamics processors, as follows:

X Toggles Expander/Gate on/off. Its LED lights when the Exp/Gate is on. This applies to input channels only.

Y Toggles Compressor/Limiter on/off. Its LED lights when the Comp/Lim is on.



These switches can be customized, globally, using [Events](#).

Channel and Gain Reduction Meters

Each channel strip features dual 30-segment signal level meters and a dedicated 10-segment dynamics meter.

Channel Level Meter

For mono channels, only the left meter shows level. For stereo channels, both meters show signal level. The pickoff point for the input and output channel meters is set on the Options > Interaction page. See [Metering](#) for information.

Dynamics Meter

The channel dynamics meter, located between the two channel level meters, show gate activity, gain reduction, and also provides a 0 dB indicator.

1 – 0 dB Indicator

The 0 dB indicator LED begins to light blue when the fader is near 0 dB. As the fader moves closer to 0 dB the LED gets brighter and is brightest when at 0 dB, making it easier to set the fader to 0 / unity. The 0 dB LED also lights blue when Flip to Faders is enabled and gain or a similar (dB) parameter is on the fader. VCA contribution also affects the state of the 0 dB indicator.

2 – Gate Meter

The gate meter provides indication of the corresponding channel's built-in expander/gate via three LEDs, which light to indicate gate activity as follows:

LED	LED Color	Expander Status	Gate Status
1 (Top)	Green	0 dB gain reduction	Gate Open & Hold
2	Yellow	3 dB gain reduction	Gate Released
3 (Bottom)	Red	>21 dB gain reduction	Gate Closed
No LED illuminated		Not in circuit	

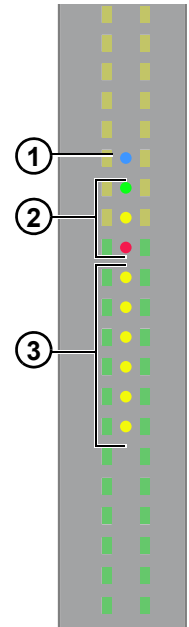

3 – Gain Reduction Meter

The gain reduction meter provides indication of gain reduction applied by the channel's built-in compressor/limiter via six LEDs, and light to indicate comp/lim activity as follows:

LED	LED Color	LED illuminates at...	LED at full brightness at...
1 (top)	Yellow	>0 dB gain reduction	1.5 dB gain reduction
2	Yellow	>1.5 dB gain reduction	3 dB gain reduction
3	Yellow	>3 dB gain reduction	6 dB gain reduction
4	Yellow	>6 dB gain reduction	9 dB gain reduction
5	Yellow	>9 dB gain reduction	15 dB gain reduction
6 (bottom)	Yellow	>15 dB gain reduction	21 dB gain reduction
No LED illuminated		Not in circuit	

Gain Reduction meters can be used to trigger [Events](#).

Fader

The fader controls the output level for the currently banked input or output channel. When Flip to Faders is active, the fader controls the send level of the parameter currently flipped to faders (see [Flip](#) for more information).

You can set a preference so that touching a fader automatically attentions that channel. See [Channel Selection](#) for more information.

Channel Color Switch

This switch lights in the color as defined in the external VENUE software (see [Color-Coding Channels from the External Screen](#)) and/or from the Master Touch Screen (see [Color-Coding Channel from the Universe View](#)).

 These switches can be customized using [Events](#).

Channel Knob Modules (CKM)

Each Channel Knob Module provides channel parameter control via 32 dual-function encoders that provide switch and rotary functions. Each CKM is associated with the bank of eight faders below it, and the Channel Touch Module above it (if present). The CKM operates in one of the following modes: Channel Strip mode or Channel Control mode.

1 – Encoder Display

The encoder display shows the parameter that is targeted to the encoder, the value of the parameter (such as dB level for gain or frequency of an EQ band), and a “virtual” encoder showing the position of the encoder relative to the parameter value. For gain parameters such as Input Gain and High--Pass Filter (HPF), the virtual encoder fills in to indicate level. For bus assign parameters, the encoder surround fills in completely when the corresponding channel is assigned, and is empty (black) when the channel is unassigned.

The display also shows the name and status of parameters that you can toggle on/off (in/out), such as Pad or HPF, and lights when that parameter is enabled. The circle in the center of the encoder ring displays the status of the encoder press function (if any), such as on/off.

2 – Sel

Sel assigns a secondary parameter to the corresponding encoder, or toggles a secondary function of the current parameter, where available.

3 – In

In toggles an individual parameter on/off, where available. For example, when EQ is assigned to the CKM, pressing the **In** switch for the knob controlling Lo band gain toggles that filter in/out. The switch lights when the parameter is enabled (in).

4 – Encoder

Rotating the encoder adjusts the currently assigned parameter, as shown in the encoder display. For certain parameters, pressing the encoder toggles the parameter on/off (such as the Hi Gain parameter when EQ is assigned). Encoders are color-coded by function. See [Encoder Color Coding](#) for more information.

5 – Channel Control Function Switch

The Channel Control Function switch assigns a group of parameters for the currently selected channel to the 32 encoders on the CKM. See [Channel Control Functions](#) for more information.

6 – Parameter Bank Switches

The Left and Right Parameter Bank switches let you assign the next or previous page of parameters to the encoders, and are available in both Channel Strip and Channel Control modes. A switch lights when there is a previous or next page of parameters to access.



Channel Strip Mode

When no channels are selected from the corresponding fader bank, the CKM operates in Channel Strip mode in which parameters are assigned to the CKM's encoders in a *vertical* orientation. Each column of four knobs corresponds to the channel currently banked to the channel strip below it, and adjusting any knob in the column applies to that channel.

Channel Strip mode provides a selection of parameters from the different channel processing functions across multiple pages. Pages are accessed using the Parameter Bank switches (< and >) below each column of knobs on the CKM. In addition, pressing and holding the < or > switches let you jump to page 1 (<) or to the last page (>). The number of pages available is determined by the number of Auxes (for Inputs) or member channels (for Outputs and VCAs), up to a maximum of eight additional pages, letting you access up to 32 Auxes, or up to 32 member channels.

To page through parameter functions in Channel Strip mode:

- To navigate a column to the next function, press > in that column.
- To navigate a column to the previous function, press < in that column.
- To return a column to the first page, press and hold <.
- To jump to the last page, press and hold >.

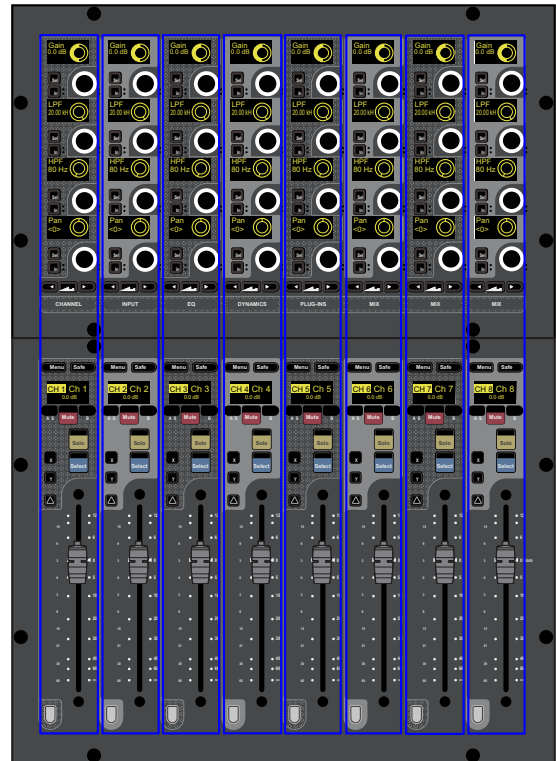

Channel Strip mode input channel parameters per page

CKM Encoder>	Page 1	Page 2	Page 3	Page 4	Page 5 (Default)	Page 6	Pages 7–N
Function	Input	EQ	Gate	Comp/Lim	Aux 1–4	Aux 5–8	Aux (next)
1 (top)	Gain	EQ Hi Gain	Gate Threshold	Comp Threshold	Aux 1	Aux 5	Aux N
2	LPF	EQ Hi Mid Gain	Gate Attack	Comp Ratio	Aux 2	Aux 6	Aux N+1
3	HPF	EQ Lo Mid Gain	Gate Release	Comp Knee	Aux 3	Aux 7	Aux N+2
4 (bottom)	Pan (Bal/Width if stereo)	EQ Lo Gain	Gate Range	Comp Gain	Aux 4	Aux 8	Aux N+3

Channel Strip mode output channel parameters per page

CKM Encoder	Page 1	Page 2	Page 3	Page 4	Page 5	Page 6	Pages 7–N
Function	Input *	EQ * Bands 1–4	EQ * Bands 5–7	Comp/Lim *	Members 1–4	Members 5–8	Members (next)
1 (top)	Polarity	EQ Lo Mid 2 Gain	n/a	Comp Threshold	1 Level	5 Level	9 Level
2	Delay	EQ Lo Mid 1 Gain	EQ Hi Gain	Comp Ratio	2 Level	6 Level	10 Level
3	Direct Out	EQ Lo 2 Gain	EQ Hi Mid 2 Gain	Comp Knee	3 Level	7 Level	11 Level
4 (bottom)	Pan (Bal/Width if stereo)	EQ Lo 1 Gain	EQ Hi Mid 1 Gain	Comp Gain	4 Level	8 Level	12 Level

* Not applicable for VCAs (column will be blank)



You can use **Encoder Assign Mode** to define one custom set of controls for each row in Channel Strip mode.

Channel Control Mode

Selecting a channel banked to a fader bank (or touching a parameter touch zone on a Channel Touch Module) enables Channel Control mode on the associated CKM. Channel Control mode provides comprehensive control over parameters such as EQ, Dynamics, plug-ins, and Aux Sends for the currently selected channel. You can also create a custom set of controls for access to 32 assignable parameters. See [Adjusting Channel Parameters](#) for more information.

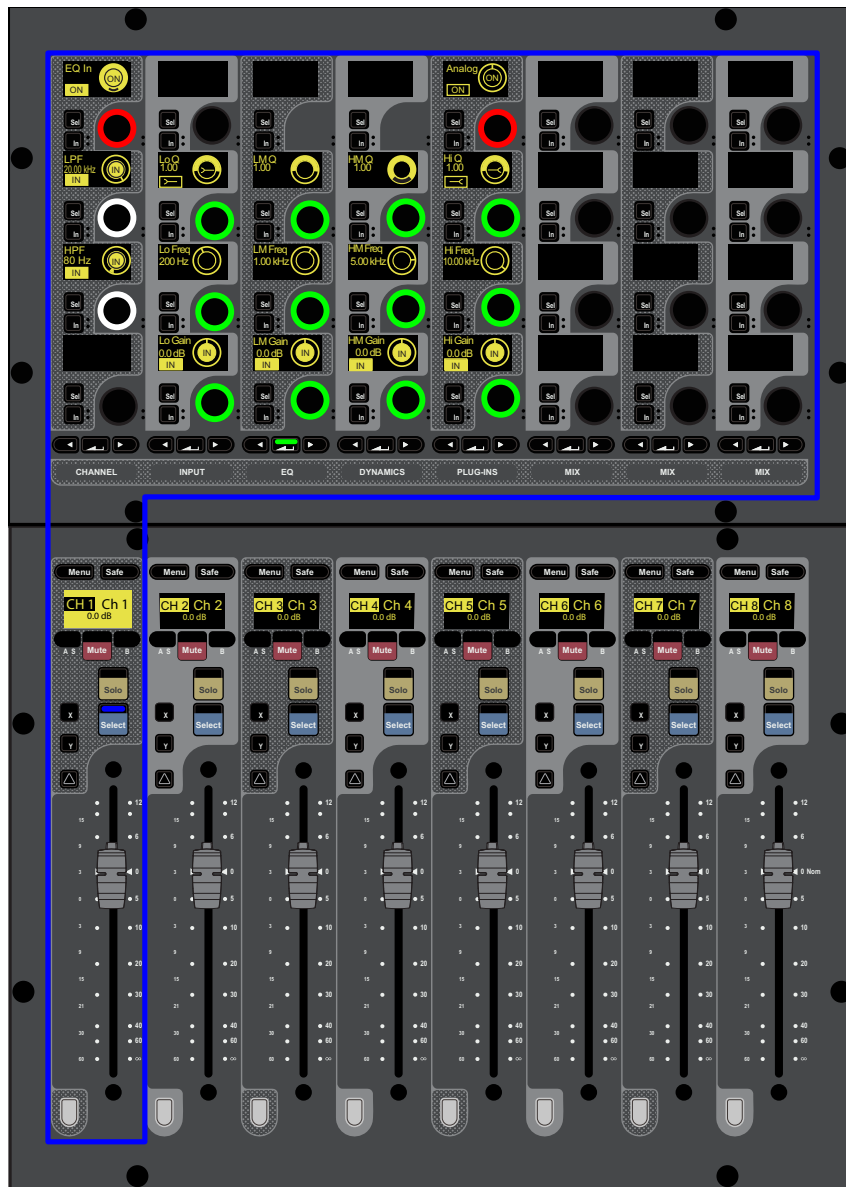

S6L in EQ Channel Control mode (input channel EQ parameters shown)

Channel Control Functions

The Channel Control Function switches assign groups of parameters for the currently selected channel to the 32 encoders on the CKM.

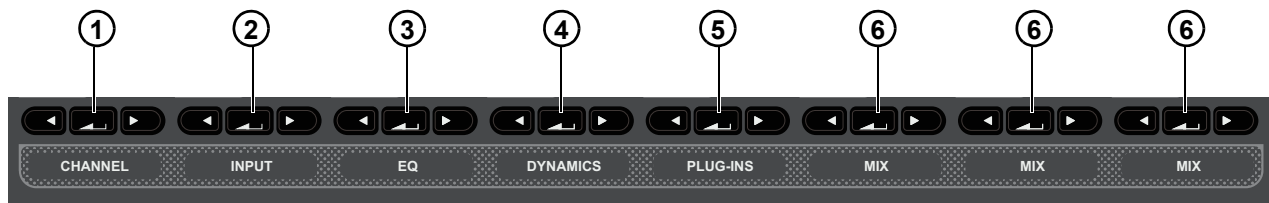

CKM Channel Control Function Switches

The labels below each switch indicate the type of parameters assigned to the CKM, as follows:

1 – CHANNEL

CHANNEL spills a variety of channel parameters such as input, EQ, and Dynamics parameters to the CKM, providing a default set of utility parameters for the selected channel. You can also customize the parameters **CHANNEL** spills to the encoders. See [Using the CHANNEL Function](#) for more information.

2 – INPUT

INPUTS spills parameters such as gain, LPF, HPF, pad, pan, phantom power (48V), polarity, channel delay, channel safes, Direct Out level, input source toggle, and Mains bus assign controls to the CKM. The available parameters depend on the type of channel selected.

3 – EQ

For input channels, **EQ** spills the built-in 4-band EQ plus high- and low-pass filters to the CKM. For output channels, **EQ** spills built-in 7-band EQ plus high- and low-pass filters to the CKM. If a graphic EQ (GEQ) is inserted on an output channel, pressing a lit Parameter Bank switch spills GEQ parameter to the encoders.

4 – DYNAMICS

DYNAMICS spills the built-in Expander/Gate (input channels only) and Compressor/Limiter to the CKM.

5 – PLUG-INS

PLUG-INS assigns four Plug-In Selectors to the leftmost column of encoders, each of which corresponds to one of the four channel Insert slots. Pressing a Plug-In Selector spills the parameters for that plug-in to the rest of the encoders on the CKM.

6 – MIX

The three **MIX** switches spill Aux, Group, or Matrix Mixer controls to the associated CKM. The type and number of Aux/Group-related parameters the **MIX** switches assign to the CKM is determined by the global Mix Bus configuration as set on the Options > System page (see [System Configuration](#) for more information).

The **MIX** switches spill the following parameters to the CKM, depending on the type of channel selected:

Aux Sends When you select an input channel, the **MIX** switches spill Aux sends and/or Group bus assignment controls to the CKM. You can assign the channel to Auxes/Groups, and adjust Aux send levels. Each **MIX** switch spills Aux Sends in sets of 32 channels, as available. Groups are always accessed via **MIX** switch three (the rightmost **MIX** switch).

Members When you select a Mains output, an Aux output, a Group output, or a VCA, the **MIX** switches spill the *member* channels (the channels assigned to that bus or VCA) to the CKM, from which you can adjust the contributing levels of the member channels to the selected bus or VCA. Each **MIX** switch spills members in sets of 32 channels, as available.

Matrix Mixers When you select a Matrix Mixer output, pressing any **MIX** switch assigns the available Matrix Mixer input controls to the CKM, letting you turn Matrix Mixer inputs on/off and adjust Matrix Mixer input levels.

Encoder Color Coding

CKM encoders light in colors according to their function or parameter in all encoder modes, as follows:

Function	Color	Parameter	Color
Channel	Parameters light in the color of the function of which each parameter is a member	Group Assign	Orange*
Input	White	Mains L-R Assign	White (Red when In)
EQ	Green	Center/Mono Assign	White (Red when In)
Comp/Lim	Blue	Processor In/Out	Red
Exp/Gate	Yellow	Plug-In Select	Red
Aux Sends/Matrix Inputs	Purple*		

** If you change the color of an Aux or Group output channel, the encoders for the sends to that output channel light in the assigned color.*

Channel Touch Module (CTM)

The S6L-32D provides three Channel Touch Modules (CTM), and the S6L-24D provides two CTMs. Each CTM is located above a CKM, and is functionally associated with that CKM and the fader bank below it. The CTM provides a local view of the channels banked to the associated fader bank. Using the CTM's touch capabilities, you can select channel functions and spill those parameters to the associated CKM. The CTM provides two views, Meters view and Channel view.

Meters View

Meters view displays parameters for each channel vertically, like a “virtual channel strip.” Each strip is composed of parameter touch zones that show the status of certain parameters for the associated channel. Parameters in each touch zone are lit when that parameter is on, and dimmed when off.

Touching a parameter touch zone simultaneously locally selects the corresponding channel *and* assigns the touch zone's parameters to the associated CKM in Channel Control mode. The active zone is indicated by an orange border. Touching an active zone de-selects the corresponding channel. Each virtual channel strip provides the following parameter touch zones:

1 – Meters and Assignments

This zone shows the associated channel's channel number and name, and level and gain reduction for the channel. Touching this zone changes the view on the CTM to a Channel view of the currently selected channel.

To the left of the meters are (from top to bottom) VCA, Mute Group, and Mains bus assignment indicators.

2 – Input

This zone shows a selection of input or output channel parameters. Touching this zone mirrors the function of the **INPUT** Channel Control Function switch.

3 – EQ

This zone shows the current EQ curve applied to the channel. Touching this zone mirrors the function of the **EQ** Channel Control Function switch.

4 – Dynamics

This zone shows a composite dynamics graph for the channel. Touching this zone mirrors the function of the **DYNAMICS** Channel Control Function switch.

5 – Plug-Ins

This zone shows the channel's Inserts slots, and any plug-ins inserted in those slots. Touching this zone mirrors the function of the **PLUG-INS** Channel Control Function switch.

6 – Aux Sends/Members/Matrix Mixer Inputs

This zone shows the following, depending on the type of channel banked to the corresponding channel strip:

Aux Sends and Groups For input channels, this zone shows the channel's Aux Sends in sets of 32, and Group bus assignments. Each send is represented by a thermometer-style meter showing individual send level and on/off status (lit is on). Touching this zone assigns the set of Aux sends indicated in the display (1–32, 33–64, 65–96, as available) to the associated CKM.

Members This zone shows Aux output, Group output, Mains output, or VCA members (channels assigned to that bus or VCA), their send levels, and on/off status in sets of 32. Touching this zone assigns the set of members indicated in the display (1–32, 33–64, 65–96, as available) to the CKM.

Matrix Mixers For Matrix Mixers, this zone shows Matrix Mixer members (channels assigned to that Matrix Mixer), their input levels, and on/off status. Touching this zone assigns the available Matrix Mixer input controls for the selected Matrix Mixer to the CKM.

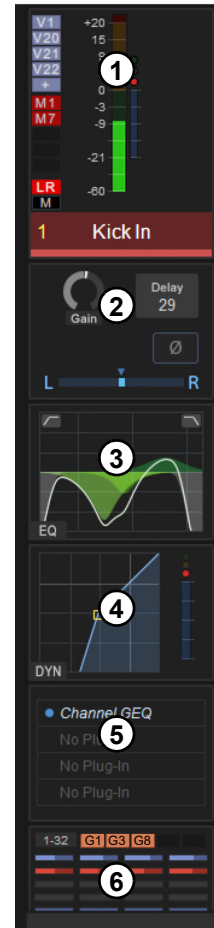

Channel View (CTM)

Touching the Meters in Meters views automatically selects that channel and replaces Meters view with Channel view. Channel view provides a complete view of the selected channel's parameters. Parameters in each touch zone are lit when that parameter is on, and dimmed when off. As in Meters view, touching a touch zone assigns its associated parameters to the associated CKM in Channel Control mode. Channel view also provides eight channel tiles, which you can touch to select, providing an uninterrupted on-screen workflow.



CTM Channel view (input channel shown)

1 – Input

This zone shows level and gain reduction meters, as well as a selection of other input parameters. Touching this zone assigns the same parameters to the CKM as the **CHANNEL** Channel Control Function switch.

2 – EQ

This zone shows the current EQ curve applied to the channel by the built-in channel EQ, and its on/off state. For output channels with a graphic EQ inserted, the current GEQ curve is also shown. Touching this zone mirrors the function of the **EQ** Channel Control Function switch.

3 – Dynamics

This zone shows a composite dynamics graph for the channel, and the dynamics processor(s) on/off state(s). Touching this zone mirrors the function of the **DYNAMICS** Channel Control Function switch.

4 – Inserts

This zone shows the channel's Inserts slots, and any plug-ins inserted in those slots, as well as the status of the channel's hardware insert. Touching this zone mirrors the function of the **PLUG-INS** Channel Control Function switch.

5 – Aux Sends/Members/Matrix Mixer

This zone provides an expanded version of the Aux Sends/Members/Matrix Mixer touch zone available in the Meters view. Three touch zones are provided, mirroring the function of the three **MIX** Channel Control Function switches.

6 – Channel Tiles

Channel view shows eight channel tiles at a time, mirroring the channels banked to the corresponding fader bank. Each channel tile shows the channel number and name. Touching a channel tile selects that channel, and targets that channel for processing, mirroring the function of the channel strip **Select** switch. When you select a channel, the channel tile is bordered in orange.

7 – Back Button

This button returns the CTM to Meters view.

Master Live Module (MLM)

The Master Live Module is the “center section” of your S6L control surface, providing system-wide controls including fader banking controls, snapshot control, transport control for playback and recording, monitoring, Mute Groups, Function switches, and more. The MLM also provides unique features such as two assignable Flex Faders, and two banks of Soft Keys, each featuring a display and associated Soft Keys and navigation switches.

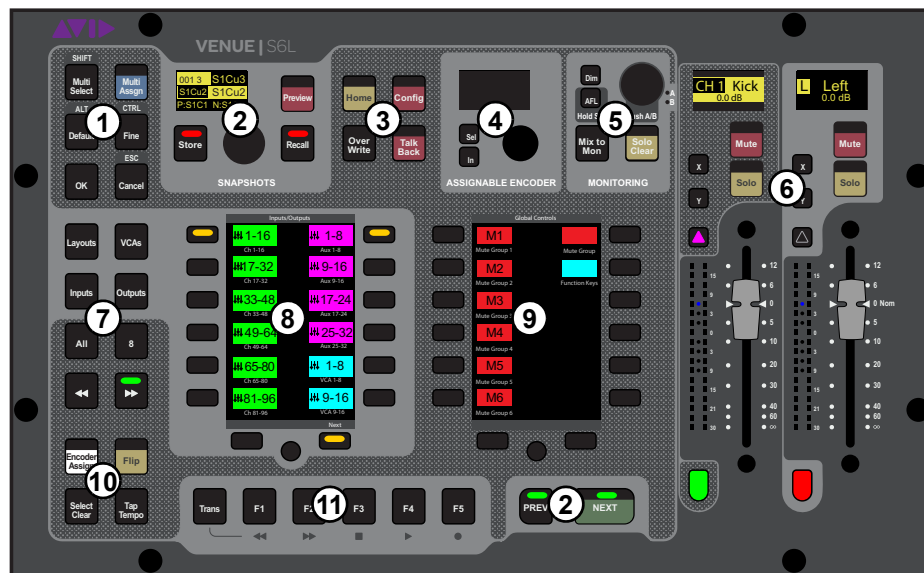

Master Live Module (MLM)

The MLM provides the following controls and indicators:

- | | |
|------------------------|----------------------------------|
| 1 – Global Modifiers | 7 – Fader Banking Controls |
| 2 – Snapshot Controls | 8 – Left Soft Keys |
| 3 – System Functions | 9 – Right Soft Keys |
| 4 – Assignable Encoder | 10 – CKM Control Switches |
| 5 – Monitoring Section | 11 – Transport/Function Switches |
| 6 – Flex Channels | |

Global Modifiers

Multi-Select (Shift)

Multi-Select lets you select or attention multiple channels, and then apply an action to all selected/attentioned channels for batch routing and assignment. For more information see [Selecting/Attentioning Multiple Channels \(Multi-Select\)](#). You can also use Multi-Select to select multiple consecutive items in the Snapshots list.

 To Multi-Select on the external screen, press the Shift key on the keyboard and select the items on-screen.



Multi-Assign

Multi-Assign Lets you quickly assign multiple input channels to a selected bus or VCA. See [Assigning Channels Using Multi-Assign](#).

Default (Alt)

Default provides a quick way to reset a control to its default setting (or “zero” the setting), such as resetting a fader to 0 dB.

To reset a fader to 0 dB:

- Hold **Default** and do any of the following on the channel strip for the channel you want to reset:
 - Touch the fader.
 - Press **Select** or **Attention**.

To reset a single parameter:

- Hold **Default** and press the encoder for the parameter you want to reset, where applicable.

To reset all parameters of a built-in channel EQ, Expander/Gate, or Compressor/Limiter processor:

- Hold **Default** and do the following:
 - Press the EQ In encoder to reset the EQ.
 - Press the E/G In encoder to reset the Expander/Gate.
 - Press the C/L In encoder to reset the built-in Compressor/Limiter.

To reset an Aux send to 0 dB and turn the send off:

- Hold **Default** and press the encoder for the Aux send you want to reset.

 To reset a parameter on the external screen, press the Alt key on the keyboard and select the parameter on-screen.

Fine (Ctrl)

Fine lets you adjust controls (except for faders) on the console or on-screen with maximum resolution. For example, if by default a control adjusts a parameter in units of 1 dB, the Fine switch allows adjustment in units of 0.1 dB.

You can also use **Fine** to select multiple non-consecutive items in the Snapshots list.

To adjust a control with fine resolution:

- Press and hold **Fine** while moving a control. The display associated with the adjusted control will show the values change at the corresponding resolution.

 To adjust a control with fine resolution on the external screen, press Ctrl on the keyboard and adjust the parameter on-screen.

Momentary and Latching Modes

Fine supports momentary and latching operation.

Momentary In momentary mode, **Fine** stays in effect for as long as you hold down that modifier switch.

Latching In latching mode, **Fine** stays in effect until you explicitly clear its active state.

To use Fine in momentary mode:

- 1 Press and hold **Fine**.
- 2 Adjust a channel, parameter, or processor.
- 3 Release **Fine**.

To use Fine in latching mode:

- 1 Double-press **Fine**. The switch LED lights.
- 2 Select or adjust one or more channels, parameters, or processors.
- 3 Press **Fine** again to exit latching mode.

OK

OK confirms the current operation, such as confirming assignments made in Multi-Select mode, or dismisses dialogs such as the Waiting for Device dialog.

Cancel (Esc)

Cancel exits the current operation, such as exiting Multi-Select mod. Holding cancel also unlocks the system if it has been locked.

Snapshot Controls

The S6L control surface provides Snapshot controls in two locations on the MLM: in the Snapshots section and the Prev/Next switches, below the right-hand MLM display. For more information on using Snapshots, see [Snapshots](#).

Snapshots Section

You can target (select), store, recall, and preview snapshots using the controls in this section.



Snapshots section

Select Encoder and Displays Turning the select encoder scrolls through and selects the targeted snapshot in the Snapshots list. The displays show the number and name of the currently targeted snapshot.

Store Saves the current state of all console parameters in the targeted snapshot. This switch mirrors the Store button on the Snapshots page.

Recall Loads the targeted snapshot. This switch mirrors the Recall button on the Snapshots page.

Preview Enables Snapshot Preview mode, and mirrors the Preview button on the Snapshots page. Preview mode lets you recall, store and edit snapshots without affecting the current mix. See [Preview Mode](#) for more information.

Prev/Next Switches

These switches instantly recall the previous or next snapshot in the Snapshots list. The switches are lit when there is a previous or next snapshot to recall.



Prev/Next Snapshot switches

System Functions

The switches in this section provide control over a variety of system-wide functions.



System Function switches

Home

Home lets you quickly return the control surface and all screens to their default states and view, but does not reset any parameters, as follows:

- Channel 1 is attentioned
- Channels are banked to the default split banking mode (where inputs are banked to outside fader banks and outputs are banked to the center fader bank, under the MLM),
- All channels are deselected and all CKMs revert to Channel Strip mode
- All CTMs show Meters view
- The MTS shows the Universe > Inputs view
- The external screen shows the Inputs page



In previous versions of VENUE software, pressing Home would also reset the Flex Channels to their default assignments (attentioned channel and Mains, as defined in Options > Interaction).

Config

Config toggles the system between Config and Show modes. Use Config mode when configuring your system (for example, when changing Bus configurations). Use Show mode during performances. For more information see [Enabling Config Mode](#). **Config** lights when Config mode is enabled.

Over Write

The **Over Write** switch on the MLM is equivalent to the Overwrite button on the Save tab of the Filing page. When pressed, a dialog is displayed asking you to confirm that you want to overwrite the currently targeted Show file.

Talkback

Talkback turns the Talkback circuit on, and operates in momentary (press-and-hold) and latching (double-press) modes.



Talkback is routed using the Options > Misc page of the external screen. See [Talkback](#) for more information.

Assignable Encoder

This encoder and associated display are reserved for future use.

Monitoring Section

The S6L system provides two discrete Monitor buses (Monitor bus A and B). The Monitoring section provide controls for the currently targeted Monitor bus.



Monitoring section

Monitoring Encoder

The monitoring encoder lets you target a Monitor bus for control and provides level control for the targeted Monitor bus, as follows:

- ◆ Push the encoder to toggle the controls in the Monitor section between Monitor bus A and B. The A or B LED lights to indicate the currently targeted Monitor bus.
- ◆ Rotate the encoder to adjust the level for the targeted Monitor bus.

Dim

This switch is reserved for future use.

AFL/Hold SIP

- ◆ **AFL** enables after-fader-listen (AFL) mode on the currently targeted Monitor bus.
- ◆ Pressing and holding **AFL** temporarily engages solo-in-place (SIP) mode.

⚠ *SIP mode interrupts audio on the Main bus. Do not engage SIP during a performance.*

Mix to Monitors

Sends the Main mix signal to the targeted Monitor bus. When enabled (lit), the Main mix is present in the headphones (or other device connected to a hardware output to which the Monitor bus is routed) whenever channels are not soloed.

Solo Clear

Solo Clear flashes when one or more channels are soloed, and does the following when pressed:

- A single press clears any solos on the currently targeted monitor bus.
- A double press clears all soloed channels.

Flex Channels

Two Flex Channels provide access to channels irrespective of the active fader layout or bank. You can configure the Flex Channels in the Fader Configuration section of the Options > Interaction page of the external screen. See [Fader Configuration](#) information on customizing the Flex Channels.

By default, enabling a channel's **Attention** switch assigns that channel to Flex Channel 1 (left), and a single fader controlling Mains Left and Right is assigned to Flex Channel 2 (right).

Each Flex Channel provides the following features:

Display Shows the channel number and name of the currently assigned channel.

Mute Mutes the currently assigned channel, and follows global Mute settings.

Solo Solos the currently assigned channel, and follows global Solo settings.

X and Y Switches Mirror the functionality of the attentioned channel's **X** and **Y** switches.

Attention Mirrors the functionality of the **Attention** switch on the channel strips.

Fader Adjusts the level for the currently assigned channel.

Channel and Dynamics Meters Show the channel level and gain reduction for the assigned channel via 18-segment and 4-segment LED ladders, respectively.

Channel Color Switch Mirrors the function of the Channel Color switch for the currently assigned channel, and lights according to the channel's assigned color-coding.

Latching a Channel to a Flex Channel

When a Flex Channel is configured to control an attentioned channel, you can “latch” the currently attentioned channel to the respective Flex Channel. When you latch a channel to a Flex Channel, attentioning another channel does not change the assignment of the Flex Channel, letting you keep constant control over your most important channel.

To latch a channel to the Flex Channel from the control surface:

- Double-press the channel strip **Attention** switch for the channel you want to latch to the Flex Channel.

To latch a channel to the Flex Channel from the external screen:

- Go to the Inputs or Outputs page.
- Touch and hold (right-click) a fader strip.
- Choose Latch <“channel name/”number>.

To unlatch the Flex Channel:

- Double-press the latched channel's **Attention** switch. Pressing Attention on another channel now assigns that channel to the Flex Channel.
– or –
- From the external screen, touch and hold the latched channel and choose Unlatch <“channel name/”number>.

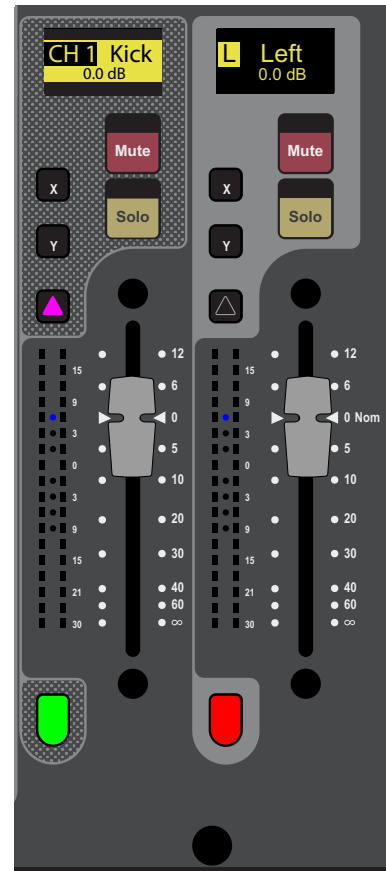

Flex Channels 1 (left) and 2 (right) showing default assignments

Fader Banking Controls

S6L lets you bank channels to faders in a variety of ways. By default, channels are banked to S6L faders in a “split” banking configuration. Input channels are banked sequentially to the fader banks below CKMs and CTMs, and output channels are banked to the fader bank below the MLM. The Left Soft Keys display shows pre-defined banks of channels, which you can bank to faders using the associated Soft Keys.

The two groups of switches in this section, the Fader Bank Mode switches and the Horizontal Banking switches, provide an alternate banking mode that let you bank only the selected channel types to all the faders on the control surface, then nudge them left or right.

 See [Banking Channels on the S6L Control Surface](#) or more information.

Fader Bank Mode Switches

The Fader Bank Mode switches (**Layouts**, **VCAs**, **Inputs**, and **Outputs**) enable Fader Bank Mode, which banks only those respective channel types to all the faders of the control surface (except Flex Channels). The Left Soft Keys display shows banks of channels containing only the types of channels provided by the selected channel type, which you can select by pressing a corresponding Soft Key. Deselecting the active Fader Banking Mode switch returns the faders to the most recent split banking configuration.

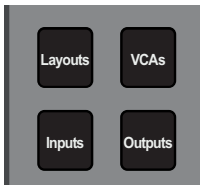

Fader Banking Mode switches

Each switch lets you bank only the following channel types to the faders using the associated Soft Keys:

Layouts Banks a custom fader configuration (“Layout”) to all faders on the S6L control surface. See [User Layouts](#) for more information on creating and using Layouts.

VCAs Banks only VCAs to all faders.

Inputs Banks only input channels to all faders.

Outputs Banks only output channels to all faders.

Horizontal Banking Switches

These switches provide horizontal banking of channels (“nudging”), and are available only when you have enabled one of the Fader Banking Mode switches.



Fader Banking Navigation switches

<<, >> Nudges channels to the left or right by one channel.

All When **All** is enabled, the << and >> switches move all channels 24 or 32 channels to the right or left, depending on your control surface. For example, if input channels 1–24 are banked to all faders on an S6L-24D, pressing >> when **All** is enabled banks input channels 25–48 to the faders.

8 When **8** is enabled, the << and >> switches move all channels eight channels (one bank) to the right or left. For example, if input channels 1–24 are banked to all faders on an S6L-24D, pressing >> when **8** is enabled banks input channels 9-16 to the left fader bank, input channels 17–24 to the center bank, and channels 25–32 to the right bank.

Left Soft Keys

Fader Banking Controls

The Left Soft Keys provide access to pre-defined fader bank layouts, as well as custom layouts. The display shows the available fader bank layouts across multiple pages. Pressing a corresponding Soft Key banks the channels indicated in the display to the faders. The available fader layouts vary depending on whether or not a Fader Banking Mode switch is enabled.

Right Soft Keys

Mute Groups, Functions, and GEQ on Faders

The Right Soft Keys provide access to Mute Groups, programmable Functions, and GEQ on Faders. Pressing a corresponding Soft Key enables that Mute Group or Function.

Mute Groups

The S6L system provides 24 Mute Groups, which let you mute groups of channels with the press of a single Soft Key. Add channels to Mute Groups using the **Mutes Channel Type** button on the Master Touch Screen (MTS).

 See [Muting and Mute Groups](#) for more information.

Functions

Customizable Functions let you control a wide range of console parameters with the press of a Soft Key. Assign actions to Functions using events, available on the **Control > Events** tab of the external VENUE software screen.

 See [Events](#) for more information.

GEQ on Faders

When GEQs are assigned to channels, they can be banked to faders with the press of a Soft Key.

CKM Control Switches

These switches primarily control functions associated with the CKMs.

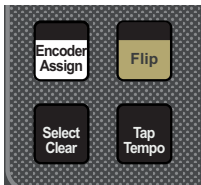

CKM control switches

Encoder Assign

This switch lets you specify a custom set of four parameters to display across rows of CKM controls in Channel Strip mode.

 See [Encoder Assign Mode](#) for more information.

Flip

Flip to Faders

Flip enables Flip to Faders mode on the control surface for input channels. Flip to Faders lets you flip any Channel Strip mode parameter to the faders on the control surface, temporarily replacing the channel level control with the currently targeted parameter. See [Flipping Parameters to Faders \(Flip to Faders Mode\)](#).

 You can also flip Aux sends to faders using [Sends on Faders mode](#). When [Sends on Faders](#) is enabled, soloing an Aux output assigns Aux Send level controls for the soloed Aux output to the faders. See [Adjusting Aux Sends on Faders \(Sends on Faders Mode\)](#).

Select Clear

Clears all selected channels and returns all CKMs to Channel Strip mode.

Tap Tempo

Sets the system tempo for use as a beat clock for delay and echo plug-ins that support Tempo Sync. The switch blinks in time with the system tempo. For more information see [Tap Tempo for Plug-ins](#).

Transport/Function Switches

These dual-function switches provide dedicated switches to control the Pro Tools Transport, as well as programmable function switches that you can use to control a wide range of system parameters using events (see [Events](#) for more information).



You must enable VENUE Link on your S6L system and in Pro Tools to use the transport controls. See the [S6L Live Recording Guide.pdf](#) for more information.



Transport controls

The following switches are provided:

Trans Toggles the F1–F5 switches between control of events and the Pro Tools Transport.

When unlit, by default the switches target pages on the external screen, as follows:

F1 Targets the Inputs page.

F2 Targets the Outputs page.

F3 Targets the Snapshots page.

F4 Targets the Plug-Ins page.

F5 Targets the Options page.

When **Trans** is lit, Pro Tools Transport controls are active, and provide the following functionality:

F1 Is reserved for future use.

F2 Is reserved for future use.

F3 Stops the Pro Tools Transport.

F4 Initiates playback in the Pro Tools Transport.

F5 Arms the Pro Tools transport *and* initiates recording.



Up to 24 Function switches are available; F1–F5 in the Transport/Function Keys section, and all 24 in the right Soft Keys of the MLM. To see the default (factory) Function key assignments, use the [Clear Console](#) command. All available Function Keys can be assigned and reassigned using [Events](#).

To access all Function Keys:

- 1 In the right Soft Keys on the MLM, press the switch for Function Keys.
The first 12 currently assigned Function switches appear in the Soft Keys.
- 2 To navigate to Functions 13–24, press the Soft Key below Next.

Master Touch Screen (MTS)

All S6L control surface models (except the S6L-16C) feature a Master Touch Screen (MTS). Located above the Master Live Module, the MTS provides a global view of S6L system channels, a Meters view, and can also provide a targeted view of the currently attentioned channel. Using the touch capabilities of the MTS, you can also perform channel actions such as attentioning, soloing, and muting channels irrespective of the active fader layout or bank, as well as assign channels to custom fader layouts.

The MTS provides three views, the Universe view, Meters view, and Channel view. With S6L-16C, Universe view and essential connection and configuration screens are provided on the external screen.

Universe View

Universe view displays a bank of up to 96 *channel tiles* at a time in six rows of 16 channels each. You can navigate to additional channel tiles by swiping vertically. You can attention channels, and enable or disable solo and mute from the Universe view, as well as target different channel types to the screen. Universe view also lets you assign channels to layouts, “favorite” channels and sort channels that appear on the screen by number, name, color, and favorite status. Other functions are available depending on the current view.

To access Universe view:

- Tap Universe at the bottom of the MTS so it lights orange.



MTS Universe view showing Inputs

Basics of Using the Universe View

- Touch a Channel Type button (2) to show those channels.
- Touch a Channel Tile Function button (5) so it lights to activate that function for the Channel Tiles (1).
- Touch a Channel Tile (1) to Attention, Mute, or Solo that channel, depending on the active Channel Tile Function button.
- Touch a Channel Tile Filter button (3) to order channels numerically by channel number, or alphabetically by channel name.

The Universe view provides the following on-screen elements. Not all elements are available in all Universe views.

1 – Channel Tile

Each channel on your system has a corresponding channel tile in the Universe. Each channel tile shows the channel's number and name, as well as its current attention, mute solo, and favorite status. A level meter is also provided.

- ◆ Touching a channel tile engages the currently selected track function for that track, as determined by the Track Function buttons.
- ◆ Double-tapping a channel tile targets that channel in the MTS Channel view.
- ◆ To access more channel tiles than are shown, swipe vertically. Depending on the channel type selected, more channels may or may not be available.

2 – Channel Type Buttons

Touching one of these buttons shows only the channel tiles for the selected channel type. Only one of these buttons can be selected at a time, and lights orange when active.

3 – Channel Tile Sort By Buttons

These buttons sort the channel tiles in the MTS Universe. One of these buttons is active at all times. Touching one of these buttons sorts channels as follows:

123 When enabled, orders channel tiles by number.

A...Z When enabled, orders channel tiles alphabetically.

4 – Channel Tile Filters

These buttons filter the channels tiles shown in the MTS. Touching one of these buttons so it lights sorts the channel tiles in the MTS Universe as follows:

Channel Color Filter (Brush) When enabled, shows channel tiles according to the color selected in the pop-up. Channels have default color-codings, which you can change. For more information see [Color-Coding Channel from the Universe View](#).



You can also color-code channels in the external VENUE software (see [Color-Coding Channels from the External Screen](#)).

Favorites Filter (Star) When enabled, shows only the channel tiles you have designated as favorites using the Star (Favorite Assign) Track Function button.

5 – Channel Tile Function Buttons

Channel Tile Function buttons determine what happens when you touch a track tile. When you select a Channel Tile Function button, touching a track tile engages the selected function for that track, as follows:

Attention Mirrors the function of the channel strip **Attention** switch.

Mute Mirrors the function of the channel strip **Mute** switch.

Solo Mirrors the function of the channel strip **Solo** switch, and adheres to global Solo settings as defined in the Options > Buses page of the external screen.

Spill Lets you rapidly access channels assigned to an Aux or Group output bus, Matrix, or VCA by spilling them to faders.

Multi-Assign Mirrors the functionality of the Multi-Assign switch on the MLM and in the external screen.

Layout Assign Lets you assign channels to a custom fader bank configuration called a "Layout." See [User Layouts](#) for more information on creating and using Layouts.

Channel Color Assign (Brush) Lets you color code channels directly from the MTS. See [Color-Coding Channel from the Universe View](#).

Favorites Assign (Star) Lets you designate one or more channels as favorites, which you can then filter in the MTS Universe view using the Favorite (Star icon) Channel Filter button.

To favorite a channel:

- 1 Tap the Favorite Assign (Star icon) Track Function button on the MTS so it lights.
- 2 Tap any channel tiles you want to favorite. A star appears in each channel tile that is designated as a favorite.
- 3 When finished, touch the Favorite Assign button again so it is unlit, or touch another Function Assign button.

To show only favorite channel tiles in the MTS:

- 1 Assign the desired channels to the channel tiles by touching a Channel Type button.
- 2 Tap the Favorite (Star icon) Channel Tile Filter button.

6 – Universe Scroller

The Universe Scroller shows channel tiles for the channels currently banked to the S6L channel strips. Swipe horizontally to view additional channels.

7 – Control Surface Configuration (Gear Icon)

The gear icon provides access to the Control Surface Configuration page, where you can view detailed information about modules and adjust LED brightness. For more information see [Troubleshooting](#).



With S6L-16C the Control Surface Configuration page is accessed on the external screen by choosing Options > Configuration.

8 – Mons A and B Level Indicators

These indicators show the Monitoring output levels of Monitor Bus A and Monitor Bus B, and change when the Monitoring encoder is adjusted, depending on the Monitor bus currently targeted by the Monitoring encoder.

Color-Coding Channel from the Universe View

You can color-code channels in the Universe view, then sort channel tiles by color.



You can also color-code channels from the external screen. See [Color-Coding Channels from the External Screen](#) for more information.

To color-code a channel from the Universe view:

- 1 Tap Universe.
- 2 Tap the Brush Track Function button so it lights.
- 3 Tap the desired color in the pop-up.
- 4 Assign the desired channels to the channel tiles by touching a Channel Type button.
- 5 Tap the channel tiles you want to color code in the selected color.
- 6 When finished color-coding, touch the Brush Track Function button so it is unlit.

The color coding is reflected in the Universe view channel tiles; on the CTM for the color-coded channels; on the Channel Color switch; on the CKM encoders for Aux Sends, Matrix input controls, Group assignment controls, and Mains assignment control; and on the fader strips and the Aux Sends section on the external screen.

To show only the channel tiles that share a color-coding:

- 1 Assign the desired channels to the channel tiles by touching a Channel Type button.
- 2 Tap the Brush Channel Tile Filter button.
- 3 Tap the desired color in the pop-up.
- 4 To remove the color-code filter, touch the Brush Channel Tile Filter button so it is unlit.

Meters View (MTS)

The MTS provides a Meters view that looks and operates just like CTM [Meters View](#). Meters view provides a local view of the channels banked to the faders below the MLM.

- Tapping a Meter switches the MTS to the Channel view for the corresponding channel. Tapping < returns to Meters view.



Meters view on the MTS

S6L-24C Meters View on MTS

When the MTS is in Meters View it shows the channels on the faders directly below it (OLEDs on those strips show a Selection outline). By default, Meters view on the 24C follows the Selected channel.

You can change this behavior to instead have the MTS Meters view be associated with whichever strips are banked below the MTS.

To configure Meters Follow Selection:

- 1 On the external screen go to Options > Interaction.
- 2 Enable or disable the Meters Follow Selection setting.
 - When enabled, Meters View on the MTS associates with the bank of channels that has a channel selected locally.
 - When not enabled, Meters View associates with the faders directly below the MTS.

Channel View (MTS)

MTS Channel view provides a detailed view of the attentioned channel's parameters, and provides most of the same on-screen elements as the [Channel View \(CTM\)](#) on the CTM.

The MTS channel view provides visual feedback for the attentioned channel's parameters but, unlike the CTM Channel view, provides no touch zones for parameter control.

To access Channel view:

- Tap Channel at the bottom of the MTS so it lights orange.

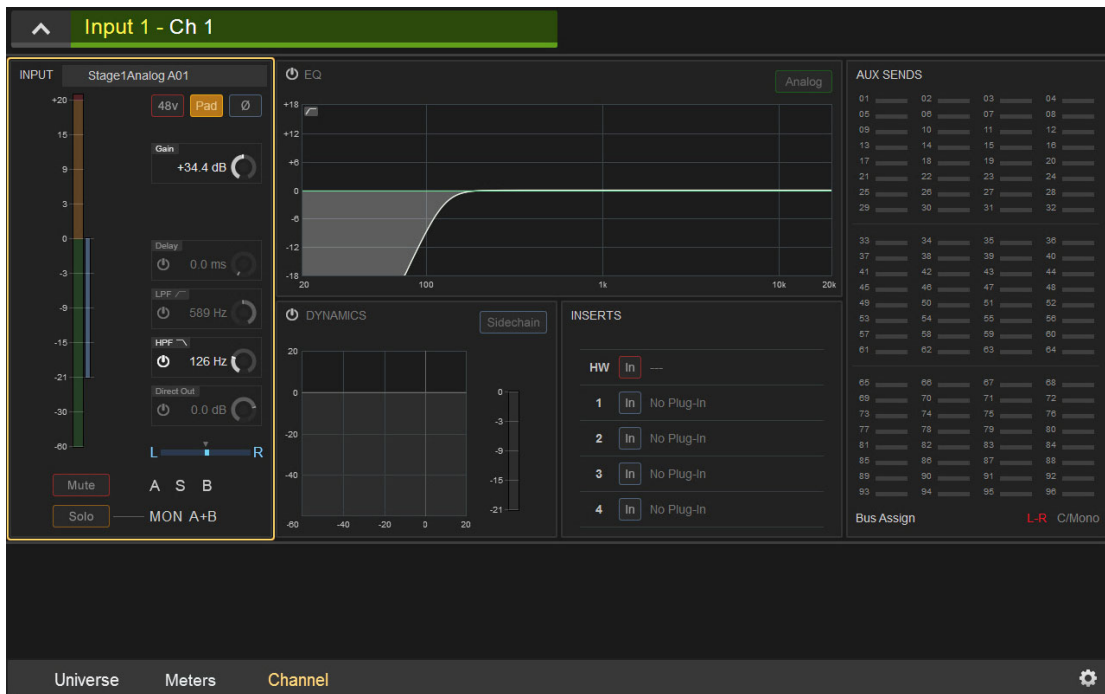

MTS Channel view

S6L Control Surface Connections

The S6L-32D, S6L-24D, and S6L-24C, and S6L-16C all have the same network and ancillary connections. Audio connections are identical on all except S6L-16C, as noted below.

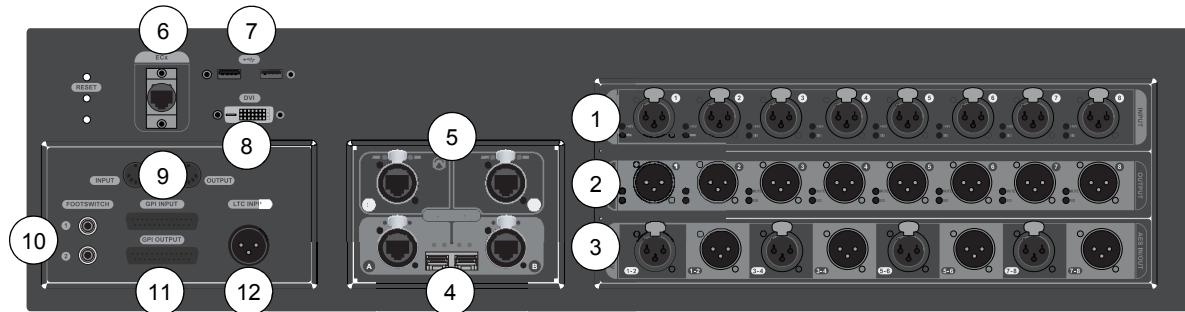

S6L control surface back panel (S6L-32D/24D/24C)

Audio Connections

(S6L-32D/24D/24C)

S6L control surface audio I/O is assigned to VENUE system channels using the Patchbay, under the Console tab. If using Local 16 I/O, its inputs and outputs appear in the Patchbay under the Local tab.

- To assign inputs, see [Patching Input Sources to Input Channels](#).
- To assign outputs, see [Patching Output Channels to Hardware Outputs](#).

1 – Analog Mic/Line Inputs 1–8 (8 XLR Connectors)

Each input features signal and 48V phantom power LEDs, which light when a signal is present and 48V is applied, respectively.

2 – Analog Outputs 1–8 (8 XLR Connectors)

Each output features an LED that lights when a signal is present on the output, and a mute LED indicator that lights when the output is muted. Outputs auto-mute when the system is powered on.

 You can mute all the outputs on the S6L control surface at once from the Devices page of the external VENUE software screen. See [Muting Stage and S6L Control Surface Outputs](#)

3 – AES Digital I/O (4 x stereo inputs, 4 x stereo outputs)

Inputs feature Sample Rate Conversion, which converts signals to the current sample rate of the system. See [Synchronization](#).

S6L-16C Audio Connections

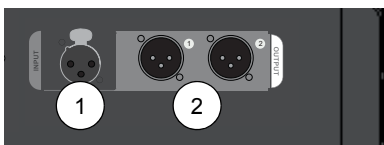

S6L-16C control surface back panel audio connectors

S6L-16C control surface audio includes the following:

1 – Analog Mic/Line Input (XLR Connector)

2 – Analog Outputs 1–2 (2 XLR Connectors)

Network Connections

3 – Network A and B

(Two etherCON RJ-45 Ports, and two SFP Fiber-Optic Ports)

The S6L control surface provides two connections (**A** and **B**) to connect the control surface to other S6L system components. Each connection provides an RJ-45 with etherCON connector for copper connections and an SFP transceiver module-compatible fiber-optic port for fiber-optic connections, as follows:

Port A Connects to port **B** on the Master 1 Network card (bottom Network card) of the E6L engine.

Port B Connects to port **A** on the last Stage 64 in a configuration, providing the redundant audio network connection for the Ring Network 1.

 Only one type of connection (copper or fiber-optic) can be active at a time for each port. Never connect both copper and fiber to the same port (A or B).

 For more information on audio network connections, see the *VENUE S6L Installation Guide.pdf*.

4 – Network Ports C and D

(Two RJ-45 Ports with etherCON Connectors)

These ports provide AVB audio network connections to system components, as follows:

Port C (Pro Tools) Connect to a compatible Pro Tools system (or other DAW) using a supported audio network cable for integrated Pro Tools recording, playback and interoperability. This connection supports up to 128 channels of simultaneous recording and playback between S6L and Pro Tools. See [Pro Tools Recording and Playback](#) for more information.

Port D Connects to a secondary compatible Pro Tools system. If only using a single Pro Tools system, use Port **C**.

 Each Network port has Act and Sig LEDs to indicate network status. See [Network Port Act and Sig LEDs](#) for more information.

5 – ECx Port

Connect a wireless router or a computer to this port to enable ECx remote control, and to be able to use VENUE | On-stage and VENUE | Function Pad apps for iOS. This port does not provide AVB audio network connections. For more information see the *ECx Ethernet Control Guide.*, *VENUE On-Stage.pdf*, or *VENUE Function Pad.pdf*.

Control and Ancillary

6 – USB Ports

(Two USB 3.0 ports)

Connect USB peripherals such as external touch screen USB, keyboards, bluetooth transmitters for wireless keyboards and mice, flash drives (for data transfer), and iLoks (for plug-in authorizations) to these ports.

7 – DVI-D Display Connector

Connect a DVI-D compatible Full HD display with 1920 x 1080 minimum resolution (21.5-inch or greater touch display recommended) to this port to view the external screen.

8 – MIDI In and Out Ports

Each MIDI port provides 16 channels of MIDI input and 16 channels of MIDI output to and from the system. You can send and receive snapshot MIDI messages, receive MIDI Time Code (MTC) from external devices, and send MTC to external devices. See [Synchronization](#) for more information.

9 – Footswitch Connectors 1–2 (2 1/4-inch TRS Connector)

Connect footswitches to these connectors. Footswitches can be normally open or normally closed, latching or momentary. Functions such as Tap Tempo for delay times are assigned to these connectors using events. See [Events](#) for more information.

10 – GPI Input and Output

S6L provides eight General Purpose Interface (GPI) inputs via a male 25-pin D-Sub connector, and eight GPI outputs via a female 25-pin D-Sub connector. Functions are assigned to GPI I/O using events (See [Events](#) for more information). You can use GPI I/O as follows:

GPI Inputs \Connect to compatible outputs of a variety of switching devices such as footswitches, momentary or latching push-button switches, or logic outputs of a larger show control system. Example applications of GPI inputs include remote toggling of a console function such as Talkback, muting a channel, or recalling a specific snapshot.

GPI Outputs Connect to compatible inputs found on a variety of external devices such as LEDs, small relays, power sequencers, and logic inputs on show control systems.

 For more information on GPI I/O, including pin-out diagrams, see [GPI Port Reference](#).

11 – Linear Time Code (LTC) Input

Connect a device that generates SMPTE Linear Time Code to this port to enable features such as automated recall of snapshots. The LTC input reads SMPTE LTC in either direction (forwards or backwards), and automatically detects 24, 25, 30 non-drop, and 30 drop-frame FPS. The S6L system's sample rate cannot be locked to LTC from this input.

S6L Control Surface Power Connections

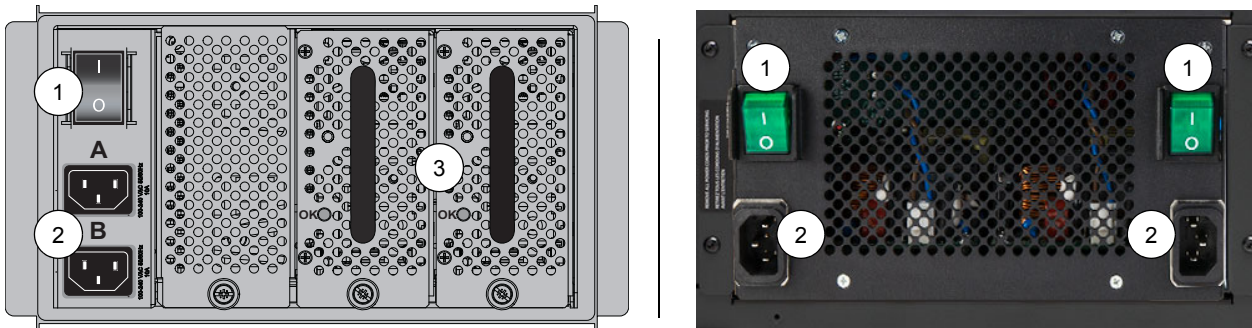

Control surface back panel: S6L-32D and 24D (shown at left), S6L-24C and 16C (shown at right)

S6L provides the following power connections, switches, and indicators:

1 – Power Switch(es)

These switches power S6L on and off, as follows:

On Applies power to each PSU in the S6L-32D and 24D, and launches system software. On S6L-24C, each PSU has its own Power switch. S6L must be connected to a powered-up E6L engine for the system software to fully launch.

Off Powers down the corresponding control surface PSU(s). VENUE software must be shut down properly from the Options > System page of the external screen before turning the power switch to off (0). See [Powering the System Up and Down](#).

2 – AC Power Inlets A and B

Connect either one of these inlets to an AC power source to provide power to both PSUs. Connect each power inlet to a discrete power source for AC source redundancy.

3 – PSUs

S6L-32D and 24D control surfaces provide dual-redundant hot-swappable PSUs with automatic failover. Each PSU provides an **On LED** that lights green when the PSU is powered on and functioning properly. S6L-24C and S6L-16C provide dual redundant, internal PSUs.

▲ *If the On LED does not light when the S6L is powered up, the PSU is faulty and may need to be replaced. For instructions on removing and replacing PSUs, see [Replacing S6L and E6L PSUs](#)*

S6L Front Panel Features

USB 3.0 Port

Connect USB peripherals such as keyboards, bluetooth transmitters for wireless keyboards and mice, flash drives (for data transfer), and iLoks (for plug-in authorizations) to this USB port.

Phones A (Left) and B (Right)

S6L-32D/24D/24C control surface provide two discrete headphone outputs, Phones A (left) and Phones B (right), each with its own volume knob. S6L-16C provide a single headphone output. The Monitor buses feed the Phones outputs, and you can assign the Monitor Bus (A or B) that feeds each Phones output on the Options > Buses page of the external screen.

Phones volume is controlled using the corresponding Phone volume knob, though the level sent to each Headphone output is in part determined by the overall level settings (such as Level Trim and Monitoring level) for the Monitor Bus that is feeding the particular Phones output. Monitor Bus A and B controls are provided in the Monitoring section of the MLM, and on the Options > Buses page of the external screen.

 *For more information on monitoring, see [Soloing and the Monitor Buses](#).*

S6L Interior Secure USB Port

One USB 2.0 port is located within the S6L control surface to connect and securely protect an iLok Smart Key. Use this port to keep one “master” iLok and its plug-in assets with the console at all times, safe from damage or loss.

 *The back cover of the S6L must be removed to access the secure USB port. For instructions see [S6L Secure USB Port](#).*

S6L-24C/16C Console Lamp Ports

The S6L-24C and S6L-16C provide two ports on the top panel for connecting goose-neck console lamps. These ports are 3-pin XLR and require LED lights. Brightness can be controlled from the Options > Interaction page of the external screen.

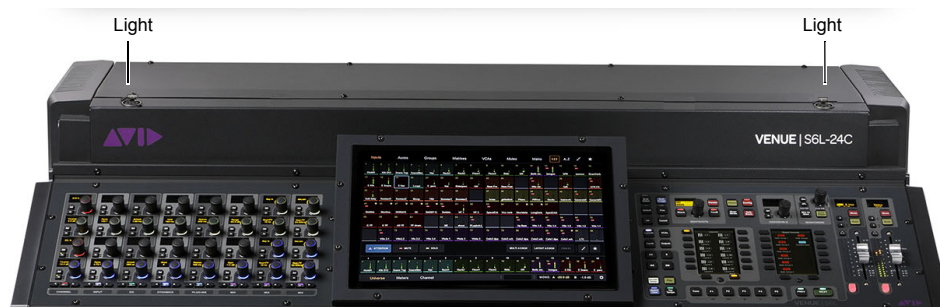

Console lamp connectors on S6L-24C and S6L-16C (24C shown)

 *S6L-32D and 24D provide a built-in light bar instead of support for external console lamps. Light bar brightness can also be adjusted from the Options > Interactions page.*

E6L Engine Overview

The E6L engine provides the real-time processing engine for input and output channels, and Pro Tools | HDX DSP processing card(s) for AAX DSP plug-ins. The E6L engine also provides audio network, synchronization, and utility connections. All E6L engine models provide the same connection capabilities.

▲ While in use, the E6L engine must be oriented horizontally, with the bottom of the engine facing downwards.

E6L Cards and Features

You can install the following expansion cards in E6L engines.

HDX-192 DSP Expansion Cards

Each E6L engine provides a single HDX DSP card in its basic configuration. E6L-192 engines support up to four HDX DSP Expansion Cards, for increased plug-in processing. E6L-144 and E6L-112 engines support up to two HDX DSP Expansion Cards. For installation instructions, see the *HDX-192 DSP Installation.pdf*.

AVB-192 Network Card

Each E6L includes one AVB-192 Network Card for connecting the E6L to other components in the system. You can add a second AVB-192 card to expand the IO capability of the system, and to connect multiple systems to utilize I/O Sharing. For installation instructions, see the *AVB-192 Network Card.pdf*.

MADI-192 MADI Option Card

The MADI-192 MADI Option Card is a high-channel-count MADI audio interface card for E6L engines. Each MADI-192 MADI Option Card provides four MADI BNC connectors (2x coaxial in, and 2x coaxial out). Each pair of coaxial MADI inputs and outputs support up to 32 channels per I/O pair.

Up to four MADI Option cards can be installed in an E6L-192 or E6L-144 engine. Up to two MADI Option cards can be installed in an E6L-112 engine. For installation instructions, see the *MADI-192 MADI Card Installation* guide.

▲ Each MADI-192 MADI Option Card also has a single BNC Word Clock Output connector. At the time of this writing, the Word Clock Output connector is not supported and should not be used.

WSG-HD Waves SoundGridOption Cards

The WSG-HD Waves SoundGrid Option Card from Avid lets you integrate Waves SoundGrid processing directly into your VENUE | S6L mixes. Once the WSG-HD Card is installed in your E6L engine, plug-ins hosted on the Waves SoundGrid server appear on the VENUE Plug-Ins screen inside of the Waves SoundGrid Rack plug-in (up to 8 plug-ins per instance of SoundGrid Rack). Up to two compatible Waves SoundGrid servers can be connected simultaneously for redundancy with automatic fail-over.

At the time of this writing, all E6L engines support a single WSG-HD card. In E6L-112 engines, either a single WSG-HD card or a second MADI-192 MADI Option card can be installed. For installation instructions, see the *WSG-HD Card Installation* guide.

E6L Front Panel

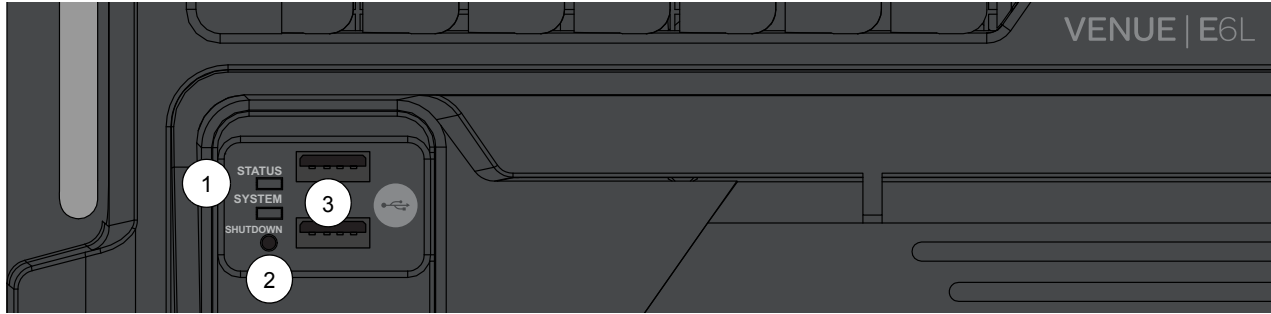

E6L engine front panel

The front panel of the E6L engine provides the following controls, connections and indicators:

1 – Status and System LEDs

These LEDs indicate the current status of the E6L engine, as described in the following table.

Status and System LEDs

LED	Color	State	Description
Status	Green	Solid	All clear (no hardware alerts are detected).
	Amber	Solid	One or more hardware alerts are detected. Consult the VENUE software Options > Devices page for detailed info.
	Off (unlit)	n/a	E6L is powered off, or is initializing during startup.
System	Green	Solid	E6L is fully operational, and connected to the S6L control surface
	Amber	Solid	E6L processor has shut down; safe to power off E6L.
		Flashing	E6L processor is initializing.
Off (unlit)	n/a	E6L is powered off, or is initializing during startup.	

2 – Shutdown (Reset)

This button shuts down the software on the E6L engine. Only use this button to shut down the E6L if the engine has been disconnected from an S6L control surface and cannot be shut down via the Shut Down button on the Options > System page of the external VENUE software screen, or for troubleshooting purposes. See [E6L Engine Emergency Shutdown](#) for more information.

3 – USB

Use these ports for installing system software and for troubleshooting and maintenance only. See [Using the System Restore Software](#) for more information.

E6L Back Panel

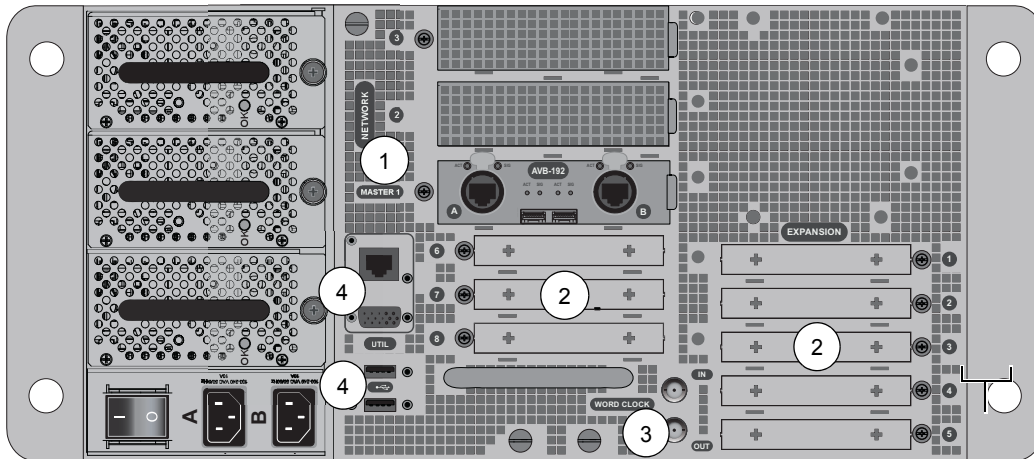

E6L engine back panel (E6L-192/144 shown; E6L-112 back panel varies slightly as noted below)

E6L Engine Audio, Control, and Synchronization Connections

The E6L engine provides the following back-panel connections:

1 – Network (AVB-192 Network Card Slots)

These slots contain AVB-192 Network cards. Each AVB-192 card provides two AVB audio network connections (**A** and **B**) to connect the control surface to other S6L system components. Each connection provides an RJ-45 with etherCON connector for copper connections and an SFP transceiver module-compatible fiber-optic port for fiber-optic connections. Only one connection type (copper or fiber-optic) can be active for each audio network connection.

 *Never connect both copper and fiber simultaneously to the same port (A or B).*

AVB / Network Card Slots	Description
Master 1	The AVB-192 Network card installed in this slot is the “master” AVB Network card in an S6L system. When no other AVB-192 Network Cards are installed, its Network port B must be connected to the S6L control surface. Port A on this card provides Ring 1 audio network connections to Stage I/O units.
2	This slot can contain a second AVB-192 Network card to expand Stage IO capacity, and to utilize I/O sharing and gain tracking.
3	On E6L-112 engines (only) this slot can contain either a second MADI-192 MADI Option card, or a WSG-HD Waves SoundGrid Option card. This slot is not supported in E6L-192 or E6L-144 engines.

 *For more information on audio network connections, see the VENUE S6L Installation Guide.pdf.*

2 – Expansion Card Slots

The back panel of the E6L engine provides eight half-length PCIe slots for Option cards such as the MADI-192 MADI Option Card. Slots 1–5 are at the lower right and slots 6–8 are in the middle (below the AVB slots). At the time of this writing:

- Up to four MADI-192 MADI Option cards can be installed in slots 1–4 in an E6L-192 or E6L-144.
- A single WSG-HD card can be installed in any E6L. In E6L-192 and E6L-144, the WSG-HD card must be installed in Option slot 6. In E6L-112 (only), the WSG-HD card must be installed in AVB Network slot 3.

For information on supported Option cards, visit <https://www.avid.com/products/venue-s6l-system>.

3 – Word Clock In and Out (Two 75 Ohm Coaxial BNC Connectors)

These ports let you connect to the word clock ports of external digital devices to sync all digital devices in your system.

 See [Clock Synchronization Overview](#) for more information.

4 – Utility (One RJ-45 Port, one VGA Display Port, and two USB 2.0 Ports)

Use these ports for installing system software and for troubleshooting and maintenance only. See [Using the System Restore Software](#) for more information.

E6L Engine Power Connections



E6L engine PSUs; E6L-192 and E6L-144 (shown at left) and E6L-112 (shown at right)

E6L provides the following power connections, switches, and indicators:

1 – Power Switch(es)

These switches power E6L on and off, as follows:

On Applies power to each PSU in the E6L-192 and E6L-144, and launches system software. On E6L-112, each PSU has its own Power switch. S6L must be connected to a powered-up E6L engine for the system software to fully launch.

Off Powers down the corresponding control surface PSU(s). VENUE software must be shut down properly from the Options > System page of the external screen before turning the power switch to off (0). See [Powering the System Up and Down](#).

 Do not power off the E6L engine until the Status LED is unlit and the System LED lights amber.

2 – A and B AC Inlets

Connect either one of these inlets to an AC power source to provide power to all three PSUs. Connect each power inlet to a discrete power source for AC source redundancy.

3 – PSUs

E6L-192 and E6L-144 engines provide three hot-swappable PSUs with automatic failover. Two PSUs are required to run the E6L engine, and the third is a redundant PSU. Each PSU provides an **On** LED that lights green when the PSU is powered on and functioning properly. E6L-112 provides dual redundant, internal PSUs.

 If the On LED does not light when the E6L is powered on, the PSU is faulty and may need to be replaced. For instructions on removing and replacing PSUs, see [Replacing S6L and E6L PSUs](#).

Stage and Local I/O Rack Overview

Stage I/O units for S6L systems include Stage 64, Stage 32, and Stage 16.

Stage 64

Stage 64 is modular, and can be configured with a variety of I/O cards. Stage 64 supports up to eight input cards and four output cards, for a total of up to 64 inputs and up to 32 outputs (analog or digital).

Stage 64 also provides features such as the Stage 64 Menu with programmable options and a corresponding display, MADI outputs, word clock output, as well as a built-in confidence monitor with level control.

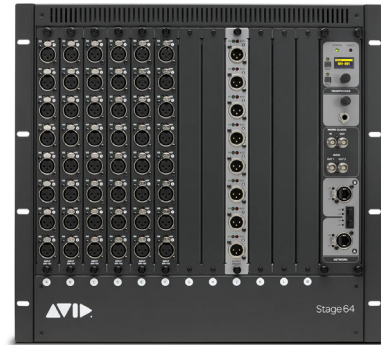

Stage 64

Stage 32

Stage 32 is also modular, and lets you connect up to 32 analog, digital, and/or Dante inputs or outputs in a 5U rack. Integrating Stage 32 into S6L systems requires dual AVB-192 Network Cards in the E6L Engine. Each Stage 32 supports up to a maximum 32 channels of inputs or outputs or a combination of both. You can customize Stage 32 with any of the same analog I/O, digital I/O, and Dante card options available for Stage 64, including SRI-192 Analog Input cards, SRO-192 Analog Output cards, DSI-192 Digital Input cards, DSO-192 Digital Output cards, and DNT-192 Dante Option cards. Stage 32 also provides MADI outputs.



Stage 32

Stage 16

Each Stage 16 provides 16 analog inputs, 8 analog outputs, and 4 digital outputs. Integrating Stage 16s into S6L systems requires dual AVB-192 Network Cards in the E6L Engine.



Stage 16

Local 16

Local 16 lets you expand your local I/O capabilities, or add primary local I/O if mixing on the S6L-16C control surface, by providing 8 XLR mic/line inputs, 8 XLR outputs, 4 pairs of XLR stereo AES/EBU inputs (8 channels total), and 4 pairs of XLR stereo AES/EBU outputs (8 channels total), similar to that on S6L-32D/24D/24C control surfaces. Up to two Local 16 units can be connected on the local (console) S6L AVB Network ring when using S6L-16C. A single Local 16 can be used with other S6L systems. Integrating Local 16s into S6L systems requires dual AVB-192 Network Cards in the E6L Engine.



Local 16

For example configurations, requirements, and connection diagrams see the *VENUE S6L Installation Guide.pdf*.

Stage 64 and Stage 32 I/O Card Features and Capabilities

You can install variety of analog and digital I/O cards in Stage 64 and Stage 32. You can purchase a pre-configured unit and modify card configurations, or purchase an empty Stage 64 or Stage 32 and configure your rack as desired. For instructions on installing I/O cards, see the *S6L Stage I/O Card Installation Guide* (for Dante card installation, see the *DNT-192 Network Card.pdf*).

SRI-192 Analog Input Card

- Eight channels of analog mic/line inputs via XLR-3 female connectors
- +48V phantom power, 20 dB pad, and phase reverse (all selectable per channel via the control surface and VENUE software)
- Signal and phantom power LEDs for each channel
- 24-bit A/D conversion, up to 192 kHz sample rate

DSI-192 Digital Input Card

- Eight channels of digital inputs via four two-channel AES/EBU XLR3-female connectors or a single ADAT TOSLINK optical connector
- Automatic sample rate conversion (SRC) and detection on input; manually defeatable for lowest possible input latency
- SRC and Lock status LEDs for both AES and ADAT connections
- Word clock output for synchronizing external digital devices

 See [Working with DSI-192 Digital Inputs](#) for information on working with DSI ADAT and SRC functionality.

SRO-192 Analog Output Card

- Eight channels of analog line outputs via male XLR-3 connectors
- Automatic muting for system protection
- Signal and Mute LEDs for each channel
- 24-bit D/A conversion

DSO-192 Digital Output Card

- Eight channels of digital outputs via four two-channel AES/EBU XLR3-male connectors and/or a single ADAT TOSLINK optical connector
- Simultaneous output to both AES/EBU outputs and ADAT optical output
- Automatic muting for system protection
- Signal and Mute LEDs for each AES/EBU channel pair

DNT-192 Network Card

- Sixteen channels of digital input or output, or eight input and eight output channels (Stage 64 only), for connecting to Dante network devices.

Stage 64 Front Panel

The front panel of the Stage 64 provides I/O card slots for I/O cards, and the Stage 64 Controller.



Stage 64 front panel (48 x 8 configuration shown)

I/O Card Slots

1 – Slots A–H (Input Cards)

Install up to eight of any combination of SRI-192 and DSI-192 input cards, or up to four DNT-192 cards, in these slots.

2 – Slots J–M (Output Cards)

Install up to four of any combination of SRO-192 and DSO-192 output cards, or up to two DNT-192 cards in these slots.

 A single DNT-192 card can also be installed in slots H and J, providing eight input and eight output channels. For more information, see the DNT-192 Dante Option Card.pdf.

Stage 64 Controller

All Stage 64 I/O racks include a Controller. The Controller provides the following features:

1 – Status and Fault LEDs

These LEDs provide the following indications:

STATUS Indicates the current status of the audio network connection to the Stage 64 Network ports.

FAULT Indicates the current status of the Stage 64 hardware, such as fan and internal temperature.

 See [S6L System Components LED Codes](#) for more information on LED codes.

2 – Stage 64 Controller Display

This display shows the current settings of the Stage 64 (via the HOME page), and provides access to various pages of Stage 64 parameters. For more information see [Stage 64 Controller Display](#).

3 – Display Selector

This knob lets you navigate through the pages and change the configurable settings provided in the display.

4 – Back

This button lets you back out of the pages and sub-pages provided in the display.

5 – Solo

This switch sends the channel selected in the Controller Menu to the Stage 64 Headphones output.

6 – Headphones

This section provides a 1/4-inch stereo jack and a level control to monitor Stage 64 input and output channel signals. For more information see [Using the Stage 64 Confidence Monitor](#).

7 – Word Clock In and Out (Two 75 Ohm Coaxial BNC Connectors)

The Word Clock Out port provides S6L system word clock output to sync external digital devices to the S6L system.

 *The Word Clock In port is not functional.*

 S6L system digital inputs also provide sample rate conversion (SRC) for synchronizing digital inputs. See [Synchronizing AES/ADAT Digital Audio Inputs \(SRC\)](#) for more information.

8 – MADI Out 1 and 2 (Two 75 Ohm Coaxial BNC Connectors)

MADI Outs 1–2 provide fixed one-for-one digital splits of up to 64 inputs from the Stage 64. For more information, see [Using MADI Outs on Stage 64 and Stage 32](#).

9 – Network A and B (Two RJ-45 Ports with etherCON Connectors and two SFP module-compatible fiber-optic ports)

Stage 64 provides two connections (**A** and **B**) to connect Stage 64 to other S6L system components. Each connection provides an RJ-45 with etherCON connector for copper connections, and an SFP module-compatible fiber-optic port for fiber-optic connections.

 *Only one type of connection (copper or fiber-optic) can be active at a time for each port. Never connect both copper and fiber to the same port (A or B).*



Making Stage I/O Unit Connections

Connecting and Assigning Stage I/O Units

Physically connect Stage I/O units to the AVB-192 cards in the E6L engine, and connect input sources and output destinations to the I/O installed in your Stage I/O units. Once connected and powered on, assign Stage I/O units in the Options > Devices page of the external VENUE software screen to available Stage slots. See the *VENUE S6L Installation Guide.pdf* for more information.

Patching Stage I/O

Once you have assigned Stage I/O units to Stage slots, you can then patch Stage I/O to VENUE system channels under the Stage 1–6 tabs in the VENUE Patchbay.

- To patch Stage inputs to VENUE system channels, see [Patching Input Sources to Input Channels](#).
- To patch outputs, see [Patching Output Channels to Hardware Outputs](#).

Stage 64 Controller Display

The Stage 64 Controller display provides pages and menus from which you can view and adjust Stage 64 parameters. The HOME page provides an overview of the current status of various Stage 64 parameters. The main MENU provides access to the MONITOR, SETTINGS, MUTE, and STATUS menus, from which you can access various Stage 64 parameters, including the built-in confidence monitor for monitoring individual Stage 64 inputs and outputs.

Stage 64 Controller Display HOME Page

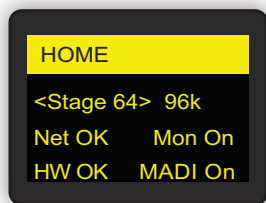

Controller Menu HOME page

The HOME page provides an overview of the current status of the Stage 64, as follows:

Name Shows the name given to the Stage 64. You can name the Stage 64 from the Options > Devices page of the external VENUE software screen, or from the Controller Menu Settings page.

Net OK/ERR Shows the current status of the audio network connection to the Stage 64 Network ports. OK mirrors a lit-green **STATUS** LED, and ERR mirrors a lit-red **STATUS** LED.

HW OK/ERR Shows the current status of the Stage 64 hardware. OK mirrors a lit-green **STATUS** LED, and ERR mirrors a lit-red **STATUS** LED.

Sample Rate Shows the current S6L system sample rate.

Mon On/Off Shows the current on/off status of the built-in Confidence Monitor.

MADI On/Off Shows the current on/off status of the Stage 64 MADI Outs.

Controller Main MENU

The main MENU lets you access the MONITOR, SETTINGS, and MUTE menus (via page 1), and the STATUS menu (via page 2).

To access the MENU page 1 (MENU 1/2):

- From the HOME page, press the Display Selector.



Main MENU page 1

Controller MONITOR Menu

The MONITOR menu lets you target a Stage 64 input or output channel for monitoring using the Headphones output on the Stage 64. See [Using MADI Outs on Stage 64 and Stage 32](#) for more information.

Using the Stage 64 Confidence Monitor

You can monitor signals from individual Stage 64 inputs and outputs using the Stage 64 Headphones output. Use this to troubleshoot individual inputs and outputs connected to the Stage 64.

To use the Stage 64 Confidence Monitor:

- 1 Connect a pair of headphones to the Headphones output on Stage 64.
- 2 From the HOME page, press the Display Selector.
- 3 Select MENU 1/2 so it is highlighted, and press the Display Selector.
- 4 Rotate the encoder so MONITOR is highlighted, then press the Display Selector. The first input of the input card installed in slot A is shown in the display (A1-01), where A1 denotes card slot A connector 1, and 01 denotes the VENUE system channel that hardware input or output is assigned to. If the channel is assigned in the VENUE Patchbay, the name of the channel appears underneath.



Monitor screen showing the first input of the input card in slot A

- 5 Rotate the Display Selector to scroll through the I/O card slots until you locate the desired channel.
- 6 Press SOLO so it lights, then adjust the volume using the Headphone level control, located above the Headphones output.
- 7 To disable the Headphone output, press SOLO so it is unlit.

Controller SETTINGS Menu

The SETTINGS menu provides two pages (SETTINGS 1/2 and SETTINGS 2/2) of configurable Stage 64 parameters, including MADI Out and confidence monitor settings. You can also name and reset the Stage 64.

To access the SETTINGS menu:

- 1 From the HOME page, press the Display Selector.
- 2 Select MENU 1/2 so it is highlighted, and press the Display Selector.
- 3 Rotate the encoder so SETTINGS is highlighted, then press the Display Selector. The first SETTINGS page is shown (SETTINGS 1/2).

The Settings menu provides the following parameters:

SETTINGS menu parameters

SETTINGS Menu Page	SETTINGS Menu Options	Parameters	Description
Page 1 (1/2)	NETWORK	n/a (only adjust when instructed to do so by Avid customer support)	View Stage 64 DHCP setting, and MAC and IP addresses
	MADI Out	SPLIT ON/OFF	Toggle Stage 64 MADI Outs on/off
	SRC	48 kHz or 96 kHz	Set the MADI Outs sample rate
	MONITOR	MONITOR ON/OFF	Toggle confidence monitor on/off (default is ON)
Page 2 (2/2)	DEVICE	NAME	Change the name of the Stage 64
		RESET	Resets the Stage 64 to default settings

 Changing any NETWORK settings on the SETTINGS menu may render your Stage 64 incapable of connecting to other S6L system components. Only adjust these settings when troubleshooting with Avid customer support.

Naming the Stage 64



You can also name the Stage 64 on the Options > Devices page of the external VENUE software screen. See [Devices](#) for more information.

To name the Stage 64 from the Stage 64:

- 1 With SETTINGS 1/2 highlighted, press the Display Selector to access the second SETTINGS page (SETTINGS 2/2).
- 2 Rotate the Display Selector so DEVICE is highlighted, then press the Display Selector.
- 3 Rotate the Display Selector so the field under NAME is highlighted, then press the Display Selector. The cursor under the first character appears.
- 4 Do any of the following to enter characters (up to a 32 character maximum)
 - Rotate Display Selector to cycle through the available characters.
 - Press the Display Selector to enter the selected character and move the cursor to the next position.
 - Press and hold the Display Selector to move the cursor to the previous position.
- 5 When you have finished entering a name, press **BACK** once.
- 6 Do either of the following:
 - To apply the new name, scroll the Display Selector to highlight **APPLY**, then press the Display Selector.
 - To cancel, scroll to highlight **CANCEL** then press the Display Selector.

Resetting Stage 64

To reset the Stage 64 from the Stage 64:

- 1 With SETTINGS 1/2 highlighted, press the Display Selector to access the second SETTINGS page (SETTINGS 2/2).
- 2 Rotate the Display Selector so DEVICE is highlighted, then press the Display Selector.
- 3 Rotate the Display Selector so RESET is highlighted, then press the Display Selector.

Controller MUTE Menu

The MUTE menu lets you mute all the outputs on Stage 64.

When a Stage 64 is used in an I/O sharing configuration, note that muting from the Controller MUTE menu mutes all outputs on that Stage 64.

To mute/unmute Stage 64 outputs from the Stage 64.

- 1 From the HOME page, press the Display Selector.
- 2 Rotate the Display Selector so MUTE is highlighted.
- 3 Press the press the Display Selector. The MUTE menu is shown.
- 4 Rotate the Display Selector so MUTE ALL is highlighted. Press the Display Selector to toggle MUTE ALL on/off. The Mute LEDs on all output connectors in the Stage 64 light when they are muted.

Controller STATUS Menu

The STATUS menu is accessed from the second page of the main MENU.

To access the STATUS menu:

- 1 From the HOME page, press the Display Selector. MENU 1/2, MONITOR, SETTINGS, and MUTE are shown in the display.
- 2 With MENU 1/2 highlighted, press the press the Display Selector to access the second MENU page (MENU 2/2).

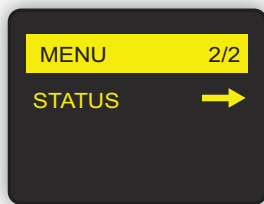

Main MENU page 2

- 3 Rotate the Display Selector so that STATUS is highlighted, then press the knob. The STATUS menu is shown, and provides pages of options detailing the current status of the Stage 64, as follows:

STATUS menu parameters

STATUS Menu Pages	Parameter	Status	Description
NETWORK	STATUS	CONN	Valid communication exists between this Stage 64 and other S6L devices on the network
		ERR	No communication exists between this Stage 64 and other S6L devices on the network
	LINK SPEED	10	Current network speed is 10mbit/second
		100	Current network speed is 100mbit/second
		1000	Current network speed is 1000mbit/second
	PORT	COPPER	RJ45 Network port is the active audio network port
OPTICAL		The fiber-optic Network port is the active audio network port	
HW MONITOR	FAN SPEED	<n> RPM	Internal fan speed in revolutions per minute
	TEMP 1	<n> c	PSU 1 temperature in Celsius
	TEMP 2	<n> c	PSU 2 temperature Celsius
FIRMWARE	Board 1	Firmware Version	Current firmware version for AVB Network card
	Board 2	Firmware Version	Current firmware version for AVB Network card

Using MADI Outs on Stage 64 and Stage 32

The two MADI Out connectors on the Stage 64, and the single MADI Out on Stage 32, provide fixed one-for-one digital splits of input channels from the corresponding unit (up to 64 input channels from Stage 64, and up to 32 from Stage 32) at a 48 or 96 kHz sample rate. These let you connect an external MADI device such as a Pro Tools | HD MADI without needing to configure the VENUE software Patchbay. You can enable and disable the MADI Outs on a per Stage unit basis.

Channel assignments for each Stage 64 MADI Out are as follows:

Sample Rate	MADI Out	Channel Assignments
48 kHz	Out 1	Stage 64 inputs 1–64
	Out 2	Stage 64 inputs 1–64
96 kHz	Out 1	Stage 64 inputs 1–32
	Out 2	Stage 64 inputs 33–64

The single MADI Out port on Stage 32 carries up to 32 input channels (depending on Stage 32 I/O configuration) regardless of sample rate.

 *The pickoff point for MADI Outs splits is post-pad, post-analog gain, and pre-digital gain.*

Configuring Stage 64 and Stage 32 MADI Outs

You can set the sample rate of Stage 64 and Stage 32 MADI outs from the external screen. You can toggle the MADI Outs on/off and set the sample rate from the Stage 64 Controller.

Setting the MADI Outs sample rate from the external screen:

- 1 Put the system into Config mode by pressing the **Config** switch on the control surface MLM so it is lit (see [Enabling Config Mode](#) for more information).
- 2 On the external screen, go to the Options > Devices page.
- 3 In the Available Devices or Connected Devices column, select the Stage 64 or Stage 32 whose MADI sample rate you want to adjust so it is highlighted in blue.
- 4 In the Information section, select the Settings tab.
- 5 Under MADI, select the Sample Rate pop-up menu and choose the desired sample rate.

Configuring Additional Stage 64 MADI Out Settings

To configure Stage 64 MADI Outs from the Stage 64 Controller:

- 1 Press and hold **Back** to make sure the Stage 64 Controller Home page is shown in the display.
- 2 Press the Display Selector once, so page 1 of the Menu is shown in the display.
- 3 Rotate the Display Selector to the right so Settings is highlighted, then press the Menu Selector so the Settings menu is shown.
- 4 Rotate the Menu Selector to the right so MADI SPLIT is highlighted, then press the Menu Selector so the MADI Split menu is shown.
- 5 To toggle the MADI Outs on/off, do the following:
 - Rotate the Display Selector to the right so SPLIT is highlighted.
 - Press the Display Selector so ON or OFF appears next to SPLIT.
- 6 To set the sample rate of the MADI outs:
 - Rotate the Display Selector to the right so SRC is highlighted.
 - Press the Display Selector so the desired sample rate appears in the display (48 kHz or 96 kHz).

Part II: Using S6L

Configuring System Audio

The chapter describes how to do the following basic system configuration tasks:

- [Powering the System Up and Down](#)
- [Confirming System Components](#)
- [Pairing the E6L and S6L](#)
- [Enabling Config Mode](#)
- [Assigning Stage I/O Units](#)
- [Assigning Local 16](#)
- [Setting the System Clock](#)
- [Configuring Mains and Mix Buses](#)
- [Managing Connections](#)

For complete hardware and software installation instructions, see the *VENUE S6L Installation.pdf*.

Powering the System Up and Down

Use the following instructions to power the system up and down for regular, day-to-day start up and shut down *after* the system(s) have been connected and configured as explained in the *VENUE |S6L Installation Guide*.

Make sure you have installed the most recent VENUE software.

⚠ *If you have not installed the most recent VENUE software, or if on initial power-up S6L prompts you to update your system, go to the Avid account linked to your S6L purchase to download the latest software and plug-in installers. Instructions for installing VENUE software are provided in the VENUE | S6L Installation Guide, available as a PDF in your Avid account.*

⚠ *Make sure no VGA monitor, mouse, keyboard, or internet is connected to the E6L engine before powering up your S6L system.*

Power up the system in the following sequence:

- 1 If more than one system is connected for I/O Sharing, do the following steps for the Clock Master system first.
- 2 If applicable, power on routers for use with ECx remote control.
- 3 Power on any connected computers for recording/playback.
- 4 Power on the connected video monitor.
- 5 Power on the E6L engine by pressing the power switch(es) on the back to the on (1) position. On the front panel of the E6L engine, the front-panel LEDs light as follows:
 - Status LED lights green.
 - The System LED begins to flash amber while the E6L is waiting to connect to the S6L control surface, then turns green when connection is complete.
- 6 Power on the S6L control surface by pressing the power switch on the back panel to the on (1) position.

The LEDs on each of the S6L's PSUs light green, and Avid logos appear on the Master Touch Screen (MTS), the Channel touch Modules (CTMs) (if present), and the external screen while the system initializes.

If you are powering up the system for the first time, or the S6L control surface is connected to a different E6L engine than it was previously connected to, the Please Select Engine screen appears on the MTS when initialization is complete.



Avid logo on-screen

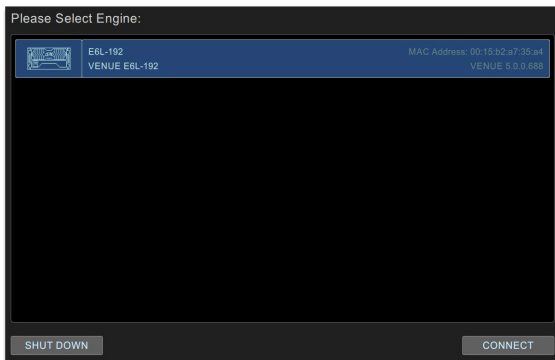

Please Select Engine Screen on the MTS

If the Please Select Engine dialog appears, complete the rest of these power up instructions and then proceed to [Confirming System Components](#).

💡 *If the E6L engine has not fully initialized by the time the S6L control surface has initialized, “Waiting for the E6L Engine to start...” appears in the MTS until the E6L finishes initializing.*

- 7 Power on the first Stage I/O unit by pressing the power switch to the On position for the PSU that is plugged into an AC power source. Stage 64: If both PSUs are connected for redundancy, power-on both PSUs. The power switch(es) lights green and the following occurs on the front panel of the Stage 64:
 - The Status LED lights green.
 - The AVID logo appears while the device initializes.
 - When initialization is complete, the Controller Menu HOME page is shown.

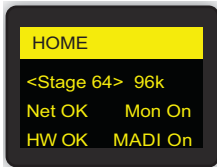

Controller Menu HOME page

- 8 Power on any other Stage I/O units in the system.
- 9 Proceed to [Confirming System Components](#).

Powering Down the System

Power down the system in the following sequence:

- 1 Turn off the audio monitoring system.
- 2 Turn off any connected computers for recording/playback.
- 3 Shut down your system by doing the following:
 - Put the system into *Config* mode (see [Enabling Config Mode](#)).
 - On the external VENUE software screen, go to the Options page and select the System tab.
 - Select Shut Down.
 - Select Shut Down again to confirm.



You can also access system Shut Down on the MTS by tapping the Gear icon in the lower right corner.

- 4 When the MTS and the external screen go black, power off the S6L control surface using the back-panel power switch.
- 5 On the front panel of the E6L engine, once the Status LED is *unlit* and the System LED is *lit amber* you can power off the E6L using the back-panel power switch.
- 6 Power off any connected Stage I/O units.

Confirming System Components

After connecting and powering up system components, you can confirm and configure system components on the Options > Devices page of the VENUE software screen.

To confirm system components:

- 1 On the external screen, select the Options button.



Options button

- 2 Select the Devices tab.

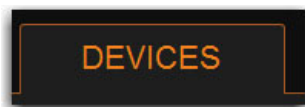

Devices tab

All connected and powered on system components appear on the Devices page. The Devices page lets you connect and troubleshoot system components, view their status, and edit hardware settings.

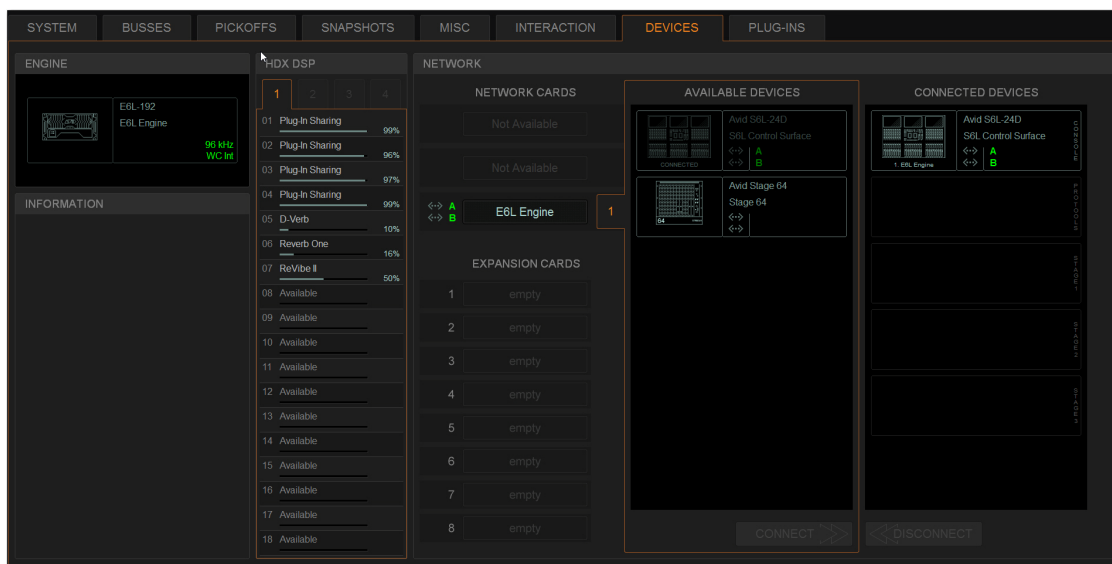

Options > Devices tab

- If any components do not appear, check all network connections between components, and make sure all components are powered on.
- It is possible for some components to appear mis-identified (for example, an S6L-24C control surface might be mis-identified as an S6L-24D). If this occurs, right-click on the image of the mis-identified component and select the correct one from the pop-up menu.
- If components still not appear, or error messages are displayed, see [Troubleshooting](#).

- 3 Proceed to [Pairing the E6L and S6L](#).

Pairing the E6L and S6L

By default, an E6L engine automatically connects to its previously assigned S6L control surface. When assigned to an E6L, the S6L controls the parameters associated with that E6L. After the initial assignment, an E6L will automatically attempt to reconnect to the most recently assigned S6L. However, you can assign any E6L to any S6L on the network.

- If you are configuring a system for the first time, have just performed a System Restore, or the S6L control surface is connected to a different E6L engine than it was previously connected to, the **Please Select Engine** screen appears on the MTS (or external screen with S6L-16C) when initialization is complete. If so, follow the instructions in [Please Select Engine](#).
- If your S6L control surface was already paired with an E6L engine, and that E6L engine is detected on the network, the system will startup as usual and automatically connect. If so, proceed to [Assigning Stage I/O Units](#). If your configuration has not changed and components were already paired prior to performing a *Software Update*, you should not need to pair them again; if this is the case, proceed to [Setting the System Clock](#).
- If you ever need to re-assign components, see [Managing Connections](#).

Please Select Engine

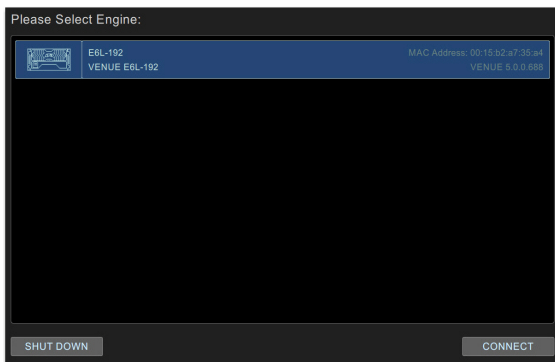

Please Select Engine Screen on the MTS (or on the external screen for S6L-16C)

 *If the E6L engine has not fully initialized by the time the S6L control surface has initialized, “Waiting for the E6L Engine to start...” appears in the MTS until the E6L finishes initializing.*

To pair your E6L engine to your S6L control surface, in the Engine Selection screen on the MTS do the following:

- 1 If you have not already done so, power on the E6L engine by pressing the power switch on the back to the on (1) position. On the front panel of the E6L engine, the front-panel Status LED lights green and the System LED flashes amber while the E6L engine initializes. On the MTS, the Please Select Engine screen appears.

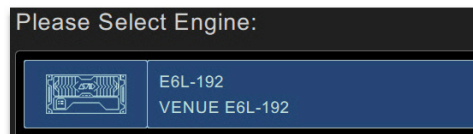

A selected E6L engine.

If multiple E6L engines are detected, all are listed.

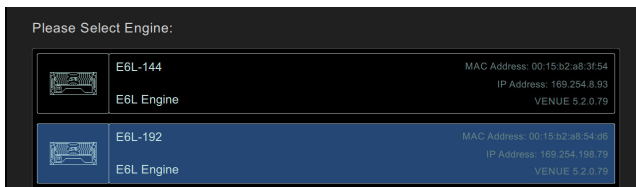

Selecting an E6L from the list of available engines (E6L-192 shown selected)

- 2 In the Please Select Engine screen, select a connected E6L engine so it is highlighted in blue.

3 Select CONNECT.



Connect button

The MTS (or external screen with S6L-16C) indicates that the S6L control surface is waiting for the E6L engine to start. When the devices connect, the Universe view appears on the MTS, and the Inputs page appears on the external screen.

 *If you have incorrectly assigned E6Ls, they must first be unassigned from the S6Ls to which they are currently assigned. See [Managing Connections](#).*

Firmware and software updates begin on various devices in the system, as follows:

- Surface modules (the Channel Fader Modules and the Channel Knob Modules), and status is indicated on the MTS.
- S6L control surface and E6L engine Network cards, and status is indicated on the Options > Devices page of the external screen.
- Any Channel Touch Modules (CTMs), and status is indicated on the CTMs.

 *On some systems the CTMs (if any) might indicate that you must power-cycle your system to complete software installation. Do not power-cycle your system at this time. Wait until the instructions in this guide tell you to power-cycle the system.*

4 On the external VENUE software screen, in the Console Network Card alert dialog, click Review to monitor the progress of firmware updates.

 *During the E6L engine update, alerts are shown indicating that connection between the S6L control surface and the E6L engine has been lost, and plug-in racks need reset. These alerts can be ignored, as they are a normal part of the update process.*

5 If desired, give each S6L and/or E6L a unique name by doing the following:

- Enable Config mode.
- In the Options > Devices tab of the external screen, select the E6L engine or S6L control surface graphic so it is outlined in blue.
- In the Information pane, select the DEVICE tab.
- Touch-and-hold (double-click) the field next to Name, enter a unique name using the keyboard, then press Enter when finished.

 *Device names are not saved as part of Show files, they are stored in the hardware unit. In addition, you cannot rename devices in the Standalone software.*

6 Proceed to [Enabling Config Mode](#).

Enabling Config Mode

There are two main operating modes for the S6L system, *Config* mode and *Show* mode. Use Config mode to accomplish tasks such as setting up your system, configuring options, loading Show files, and installing software such as plug-ins and system updates. Use Show mode to mix your performance.

To enable Config mode, do one of the following:

- 1 Press **Config** on the S6L control surface Master Live Module (MLM). The **Config** switch lights, and Config is indicated in the Mode box in the on-screen Status Bar.

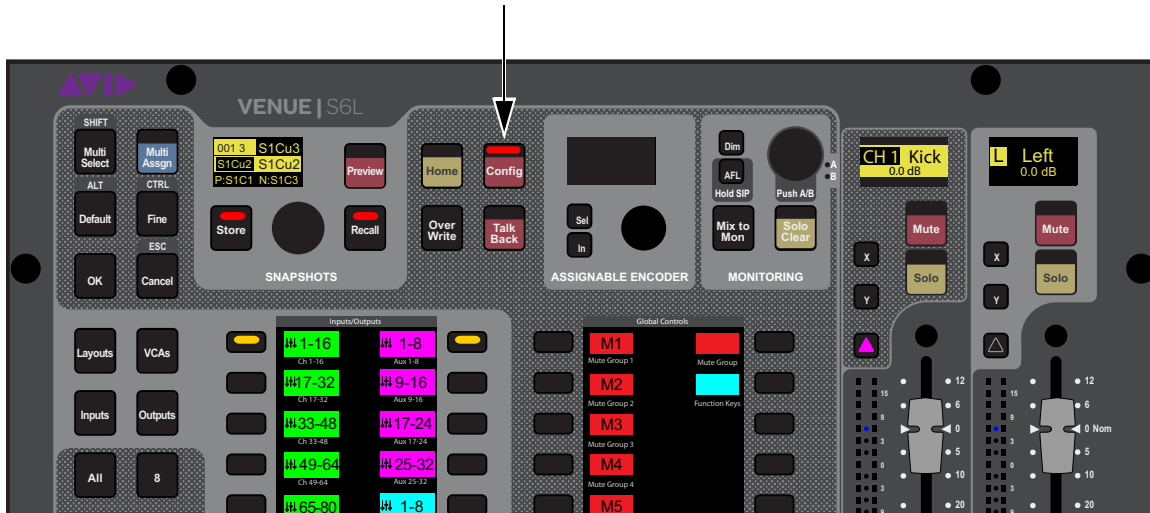

Config switch on the S6L control surface MLM

– or –

- On-screen, double-tap the Mode box in the Status Bar, located in lower-right hand corner of the screen, so that Config is shown. The **Config** switch also lights.

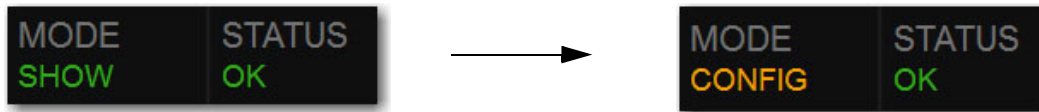

Mode box showing Show mode enabled (left) and Config mode enabled (right)

- 2 Proceed to [Assigning Stage I/O Units](#).

Assigning Stage I/O Units

When you initially configure a system, or after performing a System Restore, you must assign Stage 64, Stage 32, and/or Stage 16 I/O units to available Stage slots in the Options > Devices tab. Each Stage slot corresponds to a Stage hardware tab 1–6 in the VENUE Patchbay. A banner alert is displayed whenever the system detects one or more I/O units that are unassigned.

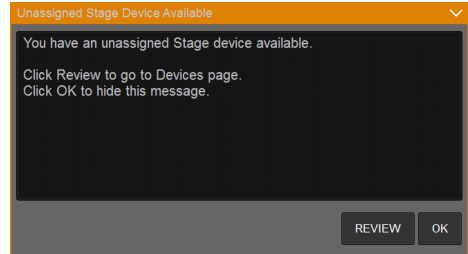

Unassigned Stage I/O alert

- If your configuration includes one or more Local 16s you must also assign them in Options > Devices. Unlike Stage I/O, however, Local 16 is assigned to S6L AVB network Ring 2. Assign Stage I/O first, as explained in the following steps, before assigning Local 16.
- If you are configuring a basic (single) system, complete the following steps to assign Stage 64s, Stage 32s, and/or Stage 16s to E6Ls.
- If you are configuring a system connected for I/O Sharing with another S6L system, complete the following steps to assign Stage I/O units to E6Ls and then see [Using Master and Slave E6Ls in Shared I/O Configurations](#).

To assign Stage I/O units (refer to Figure 1):

- 1 Make sure the system is in Config Mode (see [Enabling Config Mode](#)).
- 2 Navigate the external screen to Options > Devices.
- 3 If your configuration includes Stage 32 or Stage 16, configure Stage slots in the CONNECTED column by clicking to select the slot and then choosing the appropriate device from the selector.
- 4 In the AVAILABLE column, select the first Stage I/O device so it is highlighted (to identify units when multiple devices are present, see [Identifying Stage I/O Units](#)).

If any connected Stage I/O units do not appear in the Unassigned section, check network and power connections.

- 5 Click CONNECT.
- 6 Click to select a flashing Stage slot and assign the selected I/O unit to that slot.
- 7 Repeat for any additional Stage I/O units.

On initial power-on after performing a System Restore, firmware updates of the Stage units begin just after assigning them.

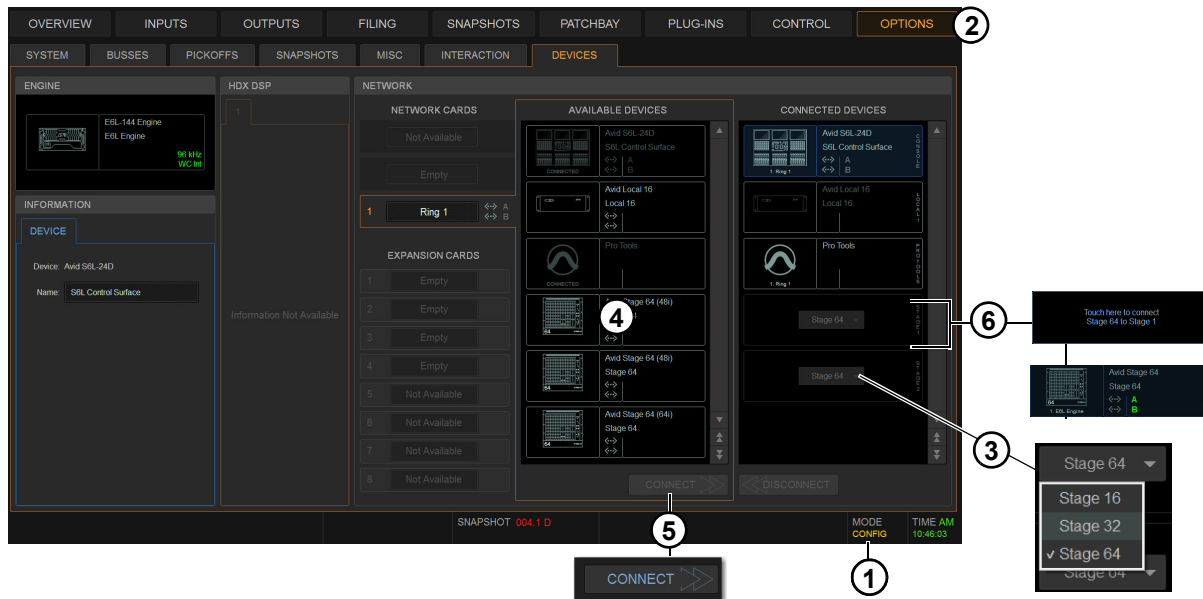

Figure 1. Assigning Stage I/O units in Options > Devices

When using more than one type of Stage I/O unit, group units by type and connect them in series in the CONNECTED DEVICES column, such as all Stage 64(s), then all Stage 32s, then all Stage 16s. The order of Stage I/O devices in the Connected Devices column does not need to match the order of physical network connections.

Virtual Soundcheck: Important Note Slot designation (1–6) determines where I/O appears in the Patchbay I/O tabs 1–6, which also determines Virtual Soundcheck channel order. For example, each Stage 16 slot occupies 16 channels of Virtual Soundcheck. However, switching any *slot* from Stage 64 to Stage 16 creates *four* available Stage 16 slots. Even if only one Stage 16 I/O unit is physically connected and the remaining three Stage 16 slots are empty, if a Stage 64 was assigned and connected to slot 5 the Pro Tools inputs corresponding to that Stage 64 will begin at channel 65. To avoid this, it is recommended to assign Stage 64s (if any) to the lowest numbered slots 1–3 whenever possible, followed by any Stage 32s, followed by any Stage 16s.

8 Once firmware updates are complete, dismiss all alerts and dialogs by selecting OK in each one.



You can reassign Stage I/O units at any time after initial software installation, and after all necessary firmware updates are completed. If you are replacing Stage units with one of a different type, simply select and Disconnect the unwanted Stage I/O unit in the Connected Devices list, re-assign the corresponding Stage slot if necessary, then assign the desired Stage I/O units. See [Managing Connections](#) for additional information.

9 If desired, give each Stage I/O unit a unique name by doing the following:

- Make sure the system is in Config mode (see [Enabling Config Mode](#)).
- In the Options > Devices tab of the external screen, select the appropriate Stage I/O graphic so it is outlined in blue.
- In the Information pane, select the DEVICE tab.
- Touch-and-hold (double-click) the field next to Name, enter a unique name using the keyboard, then press Enter.



Stage unit names will appear in the corresponding tab of the Patchbay. Device names are not saved as part of Show files, they are stored in the hardware unit. In addition, you cannot rename devices in the Standalone software.

10 Do the following:

- If your system does not include any Local 16s, proceed to the next step on this page.
- If your system does include Local 16, proceed to [Assigning Local 16](#).

11 Shut down your system by doing the following:

- Make sure the system is in Config mode.
- On the external VENUE software screen, go to the Options > System tab.
- Select Shut Down, then select Shut Down again to confirm.

12 Power down all connected components by pressing their back panel power switches to the off (0) positions, and leave all components powered-off for at least 30 seconds.



A complete power-cycle is required before using your S6L system.

13 Power the components back on in the following order:

- E6L engine
- S6L control surface
- Any connected Stage I/O units

14 Wait for the CTMs to complete their final software update, then proceed to [Setting the System Clock](#).

Identifying Stage I/O Units

It can be helpful to identify each Stage I/O unit in the Available Devices list before assignment.

To identify Stage I/O units:

- 1 Make sure your system is in Config mode.
- 2 On the external screen, go to the Options > Devices page and locate the Available Devices column. All connected and powered on Stage I/O units are shown in this column.

 *If any connected Stage I/O units do not appear in the Available Devices section, check network and power connections.*

- 3 In the Available Devices column, select the top-most Stage 64 so it is outlined in blue. The blue outline indicates that device is targeted for connection, and is targeted in the Information area of the Devices page.
- 4 In the Information area, select the Device tab so it is highlighted in blue, then select the Identify button to latch it on. The Identify button on-screen flashes, and the Status and Fault LEDs on the front panel of the corresponding Stage I/O unit flash.

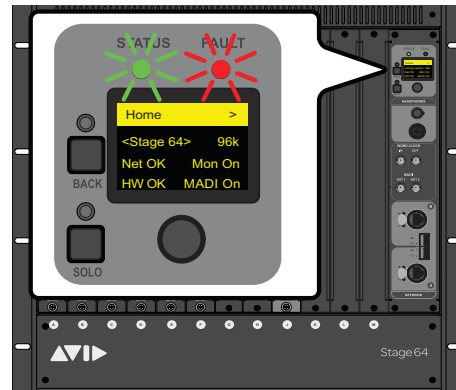
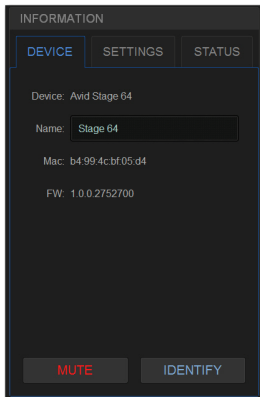

The Identify button (left) and flashing Status and Fault LEDs on the corresponding Stage 64 (right)

- 5 Select Identify again to turn it off.

Assigning Local 16

Local 16 lets you expand your local I/O capabilities, or add primary local I/O if mixing on the S6L-16C control surface. Each Local 16 provides 8 analog inputs, 8 analog outputs, 8 AES digital inputs, and 8 AES digital outputs in a compact, 3U rack.

Local 16 requires 2x AVB-192 Network cards be installed in the E6L engine. Unlike Stage I/O, Local 16 units are configured in the Option > Devices page by connecting them to the Ring 2 S6L network ring.

To assign Local 16:

- 1 Make sure the system is in Config Mode (see [Enabling Config Mode](#)).
- 2 Navigate the external screen to Options > Devices.
- 3 In the NETWORK CARDS section, select Ring 2.
Ring 2 is only available when a second AVB-192 Network Card is installed in the E6L engine.
- 4 In the AVAILABLE column, select the first Local 16 device so it is highlighted.
- 5 Click CONNECT.
- 6 Click to select a flashing Local 16 slot in the CONNECTED DEVICES column.
- 7 Repeat for any additional Local 16 units.

⚠ On initial power-on after performing a System Restore, firmware updates of the Local 16 units begin just after assigning them.

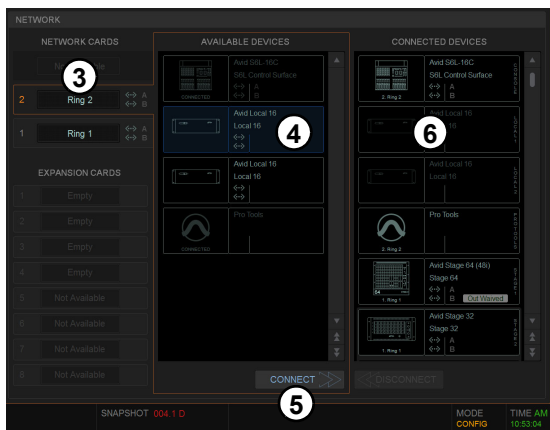

Figure 2. Assigning Local 16 in Options > Devices

- 8 Shut down your system by doing the following:
 - Make sure the system is in Config mode.
 - On the external VENUE software screen, go to the Options > System tab.
 - Select Shut Down, then select Shut Down again to confirm.
- 9 Power down all connected components by pressing their back panel power switches to the off (0) positions, and leave all components powered-off for at least 30 seconds.

⚠ A complete power-cycle is required before using your S6L system.

- 10 Power the components back on in the following order:

- E6L engine
- S6L control surface
- Any connected Stage or local I/O units

- 11 Wait for the CTMs (if any) to complete their final software update, then proceed to [Setting the System Clock](#).

Using Master and Slave E6Ls in Shared I/O Configurations

(Input and Output Sharing)

By default, such as when you first configure systems for I/O Sharing, connecting a Stage device to an E6L engine in the Options > Devices page assigns ownership of all Inputs and Outputs to that E6L (in this context “E6L” is synonymous with “S6L system”). In the following description, references to Stage 64 also apply to Stage 32 except where noted.

In shared I/O systems, the E6L to which a Stage 64 is assigned becomes the **Input Master** of that Stage 64, and other E6Ls on the network become the **Input Slave** of that Stage 64. Input Master status determines which E6L can manage shared I/O.

Input Master When an E6L is the Input Master of a Stage 64, In Master is displayed on the Stage 64 graphic in the Connected Devices column on the Options > Devices page. I/O on the Stage 64 is available to be patched to system input and output channels in the VENUE Patchbay, and the Stage tabs are highlighted in green to indicate Master status, as is the channel source box on the Inputs page on a per-channel basis.

- The Input Master system has ownership (control) of all Input slots (A–H) on that Stage 64. Individual Input slots cannot be assigned to, or controlled by, different systems simultaneously.
- By default, the Input Master system also *Claims* (controls) all Output slots (J–M) on that Stage 64. The Input Master system can assign control of Stage outputs to other systems on the network on a per-Output slot (J–M) basis from the Options > Devices page (see [Assigning Ownership of Output Slots](#)).
- The Input Master system controls inputs and outputs of Stage 16s (if any). Individual Input or Output slots on each Stage 16 cannot be assigned to, or controlled by, different systems simultaneously.

Input Slave When an E6L is Slave to a Stage 64 (for example, when another E6L on the network has already assigned a Stage 64), In Slave is displayed on the Stage 64 graphic(s) in the Connected Devices slot on the Options > Devices page. Stage inputs are freely available for patching. Stage outputs for that Stage 64 are grayed out in the Patchbay and the outputs are unavailable. The Stage tabs are highlighted in yellow to indicate Slave status, as is the channel source box on the Inputs page on a per-channel basis.

In the Options > Devices page, Input and Output ownership status is indicated on the image of each device as follows (see also [IO Sharing Example](#)):

Indication and status of Stage devices in I/O Sharing configurations

Indicator	Status
In Master	The system is the Input Master for that Stage device.
In Slave	A different system is the Input Master for that Stage device.
<i>Reminder: Inputs are controlled globally per Stage device; control of individual Input slots on a Stage device cannot be shared.</i>	
Out Claimed	The system has claimed control of <i>all</i> Output slots on that Stage device.
Out Waived	A different system has claimed, or been assigned, control for <i>all</i> Output slots on that Stage device.
Out Mixed	The system has claimed control of <i>some</i> , but not all, Output slots on that Stage device. A different system also has control of some, but not all, Output slots on that Stage device.

In the Patchbay, claimed Output slots are active and available for patching. Waived Output slots are inactive (grayed) but are still available for patching.

Stored patching to Output slots on any system on the network is unaffected by Output slot ownership. New patching is allowed to Output slots that are not claimed, similar to other inactive destinations. When an Output patch is reassigned from another patch in the same Show file, a confirmation dialog is displayed asking you to confirm the new assignment.

Before assigning Stage 64s in shared configurations, you should take into account the following differences in functionality between Input Master and Input Slave E6Ls for a connected Stage 64 or Stage 16 (as applicable). Unless otherwise noted, functionality specified for Stage 64 also applies to Stage 32.

Functionality	Master E6L	Slave E6L
Stage 64 Input Mic Preamp Control	Yes (analog gain)	Yes (digital trim)
Control of Stage 64 pad	Yes (analog pad)	Yes (digital pad)
Control of Stage 64 phantom power	Yes	No
Gain Tracking	n/a	Yes
Routing to Stage 64 Outputs	Yes	No
Routing to/from local IO (Console and Engine I/O)	Yes	Yes
Patching Stage Inputs to Input Channels	Yes	Yes
Reordering Input Channels	Yes	Yes
Mute All Outputs functionality from GUI	Yes	No
Mute All Outputs status indication	Yes	Yes
Identify functionality from GUI	Yes	Yes
Identify status indication	Yes	Yes
Ability to rename an assigned Stage 64	Yes	No
Ability to unassign a Stage 64	Yes	No

 For example, if you need to connect stage monitors to the Outputs on a particular Stage I/O unit, make sure to assign some or all Output slots on that Stage I/O unit to the E6L controlling the monitor mix.

Assigning Ownership of Output Slots

You can assign and reassign Output slot ownership in the Options > Devices page of the current Input Master system.

 Output Slot ownership can only be assigned for Stage 64s or Stage 32s, not for Stage 16s (the Input Master always controls all Stage 16 Input and Output slots) or Local 16.

To reassign Stage Output ownership:

- 1 On the Input Master system, go to Options > Devices and select a connected Stage 64 on-screen.
- 2 In the Information section, tap the Settings tab for the currently selected Stage 64.
Ownership is shown as Claimed or Waived to <E6L Device Name> S6L system.

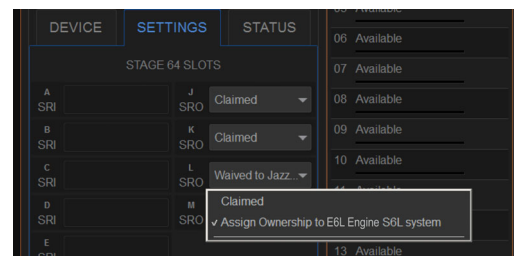

- 3 From the pop-up selector for the desired Output slot, select either of the following:
 - To claim control of that slot, choose Claim.
 - To assign ownership of that slot to a different system on the network, choose Assign Ownership to <E6L Device Name> S6L system.

IO Sharing Example

The following diagrams show how shared Input and Output ownership is indicated on-screen when two example systems are configured for IO Sharing. The two systems share three Stage 64 IO racks. In the diagrams, the corresponding Stage 64 Input and Output slots are shown with matching color outlines:

- System 1 is the Input Master, and controls all inputs on Stage 1 and Stage 2. All inputs on Stage 3 are claimed by System 2.
- System 1 has claimed control of all outputs on Stage 1. All outputs on Stage 2 are assigned to System 2.
- Ownership of outputs on Stage 3 are shared; slots **J** and **K** are claimed by system 1, while slots **L** and **M** are assigned to system 2.

System 1 The figure below shows how Input and Output ownership is indicated in the Options > Devices page of system 1.

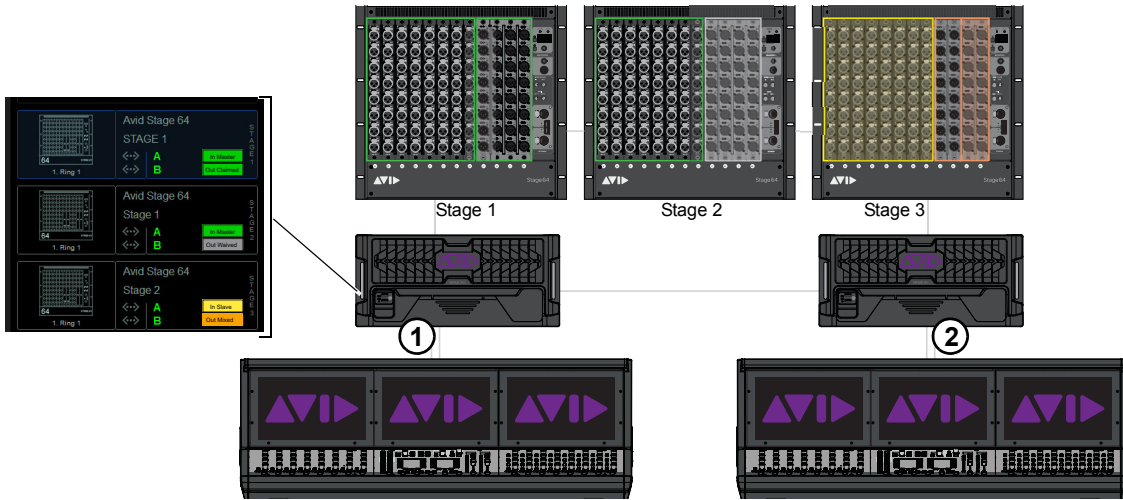

Indication of Input and Output ownership in Options > Devices for system 1 (shown at left)

System 2 The figure below shows how Input and Output ownership is indicated in the Options > Devices page of system 2.

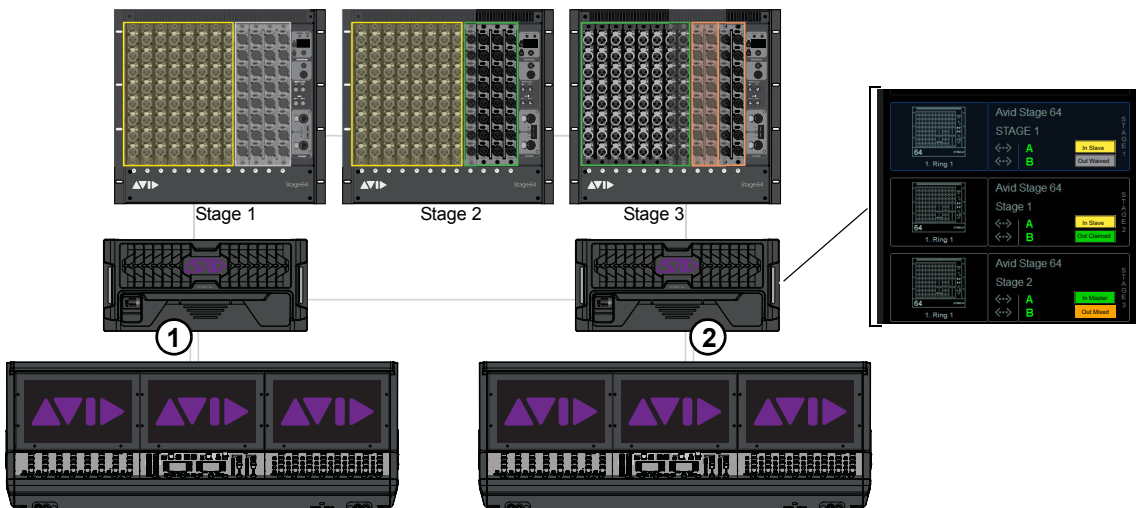

Indication of Input and Output ownership in Options > Devices for system 2 (shown at right)

Patchbay The figure below shows how ownership of specific Output slots on Stage 3 is indicated in the Patchbay on each system. In this example, slots **J** and **K** are claimed by system 1 and slots **L** and **M** are claimed by system 2.

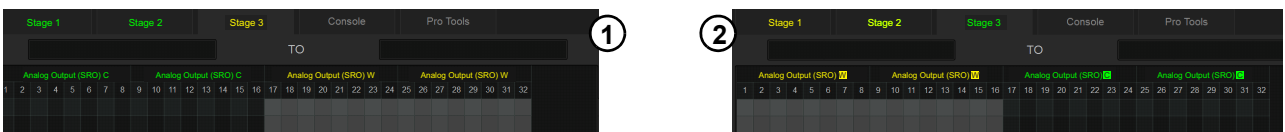

Patchbay, Outputs tab for Stage 3 on system 1 (at left) and system 2 (at right)

The following steps show how you would assign Stage 64 IO ownership to achieve the example configuration.

To configure the IO Sharing Example:

- 1 Pair each E6L to its S6L control surface.
- 2 On system 1 go to Options > Devices and do the following:
 - Select and Connect Stage 64 1. System 1 becomes the Input Master for Stage 1.
 - Select and Connect Stage 64 2. System 1 becomes the Input Master for Stage 2.
 - Tap to select Stage 64 2 in the Connected column so it is outlined in blue, then tap the Settings tab in the Information section. From the pop-up selector for Output slot **J**, choose Assign Ownership to <E6L Device Name> S6L system (where “E6L Device Name” is the name of the E6L of system 2). Repeat for the remaining Output slots (**K**, **L** and **M**) on Stage 64 2. System 2 now controls all Output slots on Stage 2.
- 3 On system 2 go to Options > Devices and do the following:
 - Select and Connect the Stage 64 3. System 2 becomes the Input Master for Stage 3.
 - Tap to select Stage 64 3 in the Connected column so it is outlined in blue, then tap the Settings tab in the Information section. From the pop-up selector for Output slot **J**, choose Assign Ownership to <E6L Device Name> S6L system (where “E6L Device Name” is the name of the E6L of system 1). Repeat for Output slot **K** Stage 64 3. Output slots on Stage 3 are now shared: System 1 controls Output slots **J** and **K**, and system 2 controls Output slots **L** and **M**.
- 4 Proceed to [Setting the System Clock](#).

Setting the System Clock

When you first set up an S6L system (or after a system update or restore), make sure the system clock time, date and time zone are set appropriately. System Clock is set on the Options page of the external VENUE software screen.

 *The system clock time can be shown in the Status bar for constant time-of-day display. For more information, see [System Clock](#).*

To set the System Clock:

- 1 On the external screen, select Options, then select the Misc tab.

 *If necessary, minimize (but do not Cancel) the Windows. Activation alert by touching the down arrow at the top-right of the dialog.*

- 2 In the System Clock section, select the Format pop-up menu to set the time format (12 Hour AM/PM or 24 Hour).
- 3 Select the Edit button in the System Clock section.
- 4 Select the Zone pop-up to choose the appropriate time zone.

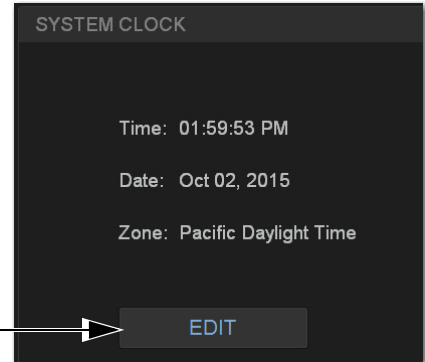

 *On touch screens, touch in a field and slide your finger up or down on the screen to increase or decrease the value in the field.*

- 5 Select each available field and enter the appropriate data to set the time and date.
- 6 Select Apply.
The new System Clock settings are applied.

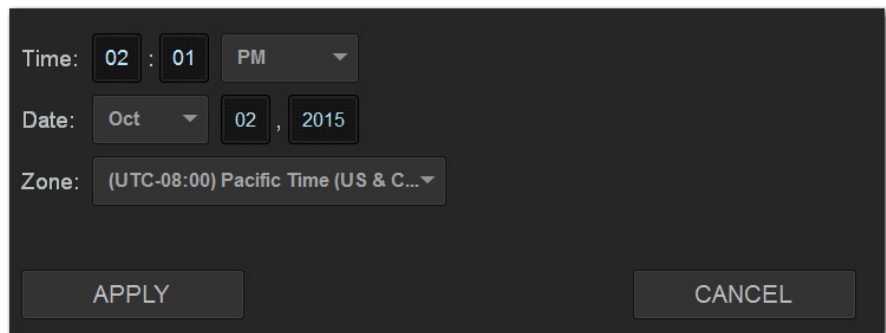

How to Proceed

- If prompted to activate Windows, refer to the instructions in the *VENUE S6L Installation Guide.pdf*.
- Make sure you have completed all other steps in the *VENUE S6L Installation Guide.pdf* to install VENUE plug-ins, optional software, make optional connections such as Pro Tools and ECx Ethernet Control, and installed and configured Pro Tools and iLok assets.
- After hardware and software installation is complete, proceed to [Configuring Mains and Mix Buses](#).

Configuring Mains and Mix Buses

After assigning Stage I/O units you can configure the Mains bus and the Mix Buses on your system. Bus configurations are stored with the Show file, so when you load a different Show file the bus configuration may change if bus configurations in the newly loaded Show file differ from the previous bus configurations.

⚠ *Audio is interrupted when a System Configuration setting is applied. Do not change these settings during a performance.*

Configuring the Mains Bus

The Mains bus can be configured to operate as either of the following:

L–R plus Mono Pans signals between the left and right channels to the L–R bus, and sums signals to a separate mono bus.

L–C–R Pans signals across left, center and right channels. You can the amount of center-panned signal that is sent to the center output (see [Panning \(Mains Center Divergence\)](#)).

To configure the Mains bus:

- 1 Put the system into Config mode.
- 2 On the external screen, go to Options > System.
- 3 Select Edit.

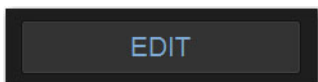

Options > System Edit button

- 4 In the Mains Bus section, select L-R plus Mono or L-C-R.

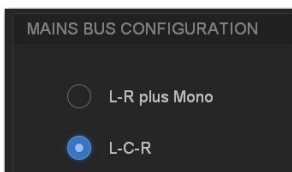

L-C-R selected as Mains bus configuration

- 5 Select Apply (or select Cancel to cancel the operation). The system restarts with the new Mains bus configuration

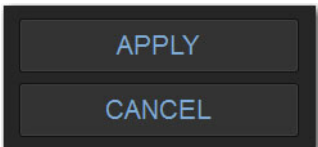

Apply and Cancel buttons.

Configuring Mix Buses

You can choose the total number of Mix buses available on the system (up to the maximum available Mix buses), and you can configure the Mix buses to provide only Aux buses, or combinations of Aux and Group buses. Setting the number of Mix buses to only the number you need can reduce clutter on the various screens, but doing so has no effect on processing bandwidth.

⚠ *Graphic EQ and/or channel EQ settings may be lost when configuring Mix buses, so save any important EQ settings before re-configuring. [Input Channel, EQ, and Dynamics Presets](#)*

To configure the Mix buses:

- 1 Put the system into Config mode.
- 2 On the external screen, go to Options > System.
- 3 Select Edit.
- 4 Do any of the following:
 - From the Total Mix Buses pop-up, chooses the total number of Mix buses you want your system to provide.
 - To include Groups in your configuration, from the Group Buses pop-up choose the number of Mix buses you want to designate as Groups.

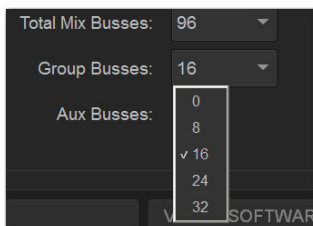
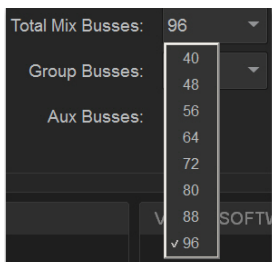

Total Mix Buses pop-up menu (left), and the Group Buses pop-up (right)

- 5 Select Apply. The system restarts with the new bus configuration.

Data Cleared When Changing Bus Configurations

When the bus configuration is changed, settings for Groups are cleared (or set to default) from all current settings and from all stored snapshots.

💡 *A new default file `OnStagePasswords.example.txt` is created on the S6L control surface D: drive whenever the bus configuration is changed. This will not change any currently active On-Stage passwords, but the new bus configuration will be reflected in the newly generated “example” txt file. For more information, see the [VENUE On-Stage.pdf](#).*

Managing Connections

After initial setup, devices on the network can be named and renamed, reassigned, and removed.

 In the following sections, references to “Stage I/O devices” includes Stage 64, Stage 32, and Stage 16 (but not Local 16).

Naming System Components

You can name the S6L control surface, the E6L engine, and any connected and assigned Stage I/O devices. The device name is stored with the respective device, and stays with that device until it is changed. Names can be changed at any time. Though not required, naming components is highly recommended.

To name S6L system components:

- 1 In the Options > Devices tab of the external screen, select the component graphic so it is outlined in blue.
- 2 In the Information list, select the DEVICE tab.
- 3 Touch-and-hold (double-click) the field next to Name, then enter a unique name using the keyboard, then press Enter when finished.

Managing Stage I/O Unit Connections

When power-cycling your system and/or reconnecting Stage I/O devices to the same E6L engine, the original Stage 1–6 assignments are automatically recalled, regardless of the order in which Stage devices are connected. Depending on the hardware combinations being used, however, you may want or need to reconfigure system Stage I/O. You can reconfigure Stage I/O on the Options > Devices tab any time after the initial system set up and configuration. You can reassign connected Stage I/O racks, remove Stage I/O racks from the current configuration, and add new Stage I/O racks to the current configuration.

Reassigning a Stage I/O Rack

You can reassign a Stage device to a different Stage slot. For example, for a particular stage setup you may want to rearrange the order of Stage 64 I/O racks as they appear in the VENUE Patchbay. Or you might want to add one or more Stage 32 or 16 I/O units.

To reassign a Stage I/O unit:

- 1 Put the system into Config mode.
- 2 Go to Options > Devices.
- 3 Select a Stage device in the Connected Devices column, then select the Disconnect button.
The unassigned Stage device appears in the Available Devices column.
- 4 Re-assign Stage I/O racks as necessary.

Configuring Stage Slots for Stage 16s, Stage 32s, or Stage 64s

When adding Stage 16s or Stage 32s for the first time, or when reconfiguring a system to use Stage 64s instead of Stage 16s or Stage 32s, you must first configure Stage slots before you can assign Stage I/O units in the Options > Devices tab. Each Stage slot corresponds to a Stage hardware tab 1–6 in the VENUE Patchbay.

 You can configure Stage slots and assign devices in VENUE Standalone Software (requires version 5.5 or higher).

To configure Stage slots and assign Stage 16 I/O racks:

- 1 Make sure your system is in Config mode.
- 2 On the external screen, go to the Options > Devices page and locate the Connected Devices column.

By default, three Stage 64 slots are displayed in the Connected Devices column.

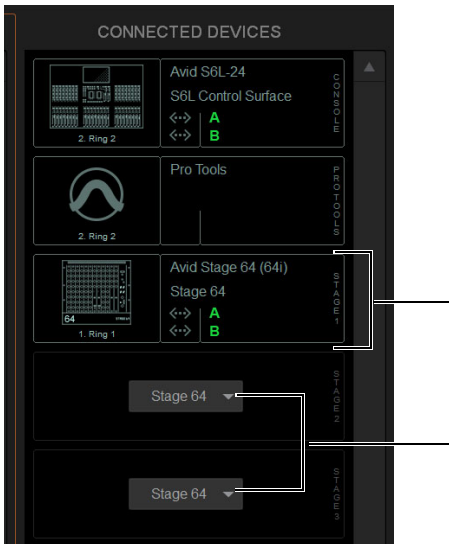

Connected Devices showing one connected Stage 64 in slot Stage 1 (above), and Stage slot Type selectors in slots 2 and 3 (below)

- 3 Select any available slot Type selector and choose Stage 32 or Stage 16 from its pop-up menu.
Up to four Stage 16 slots, or up to two Stage 32 slots, appear in the Connected Devices column.

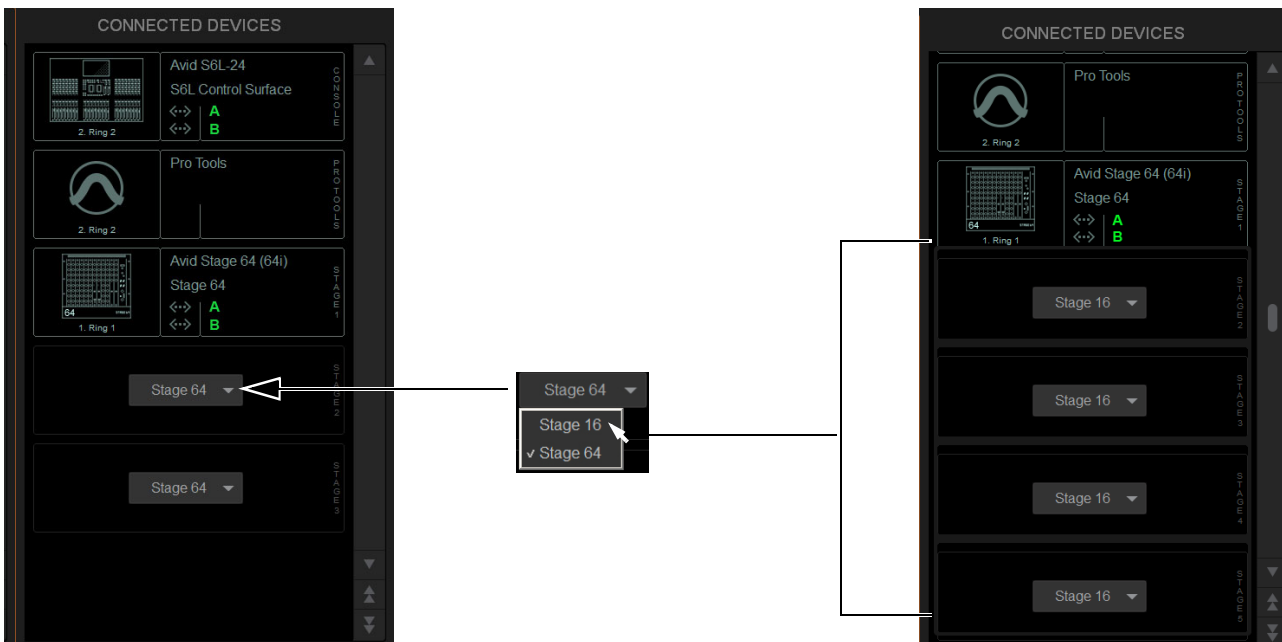

Stage 16 slots available in Options > Devices

The number of available Stage slots that appear is determined by the number of connected Stage 64s (if any), allowing for the maximum supported configurations to be connected. For example, when one or two Stage 64s are already connected configuring the third available slot to Stage 16 makes four Stage 16 slots become available. When three Stage 64s are already connected, no additional slots are available.

Virtual Soundcheck: Important Note When configuring system audio in Options > Devices, it is recommended to assign Stage 64s (if any) to the lowest numbered slots 1–3 whenever possible, followed by any Stage 32s, followed by any Stage 16s. The order of Stage I/O devices in the Connected Devices column does not need to match the order of physical network connections. Slot designation (1–6) determines where I/O appears in the Patchbay I/O tabs 1–6, which also determines Virtual Soundcheck channel order. For example, because each Stage 16 slot occupies 16 channels of Virtual Soundcheck, when switching any slot from Stage 64 to Stage 16 the 4 resulting Stage 16 slots will occupy 64 channels of Virtual Soundcheck. Even if only one Stage 16 I/O unit is connected and three Stage 16 slots are empty, followed by slot 5 assigned and connected to a Stage 64, the Pro Tools inputs corresponding to that Stage 64 will begin at channel 65. To avoid this, it is recommended to assign Stage 64s (if any) to the lowest numbered slots 1–3 whenever possible, followed by any Stage 32s, followed by any Stage 16s.

- 4 In the Available Devices column, select the desired Stage I/O device so it is outlined in blue.
- 5 Select the Connect button at the bottom of the Available Devices column.
- 6 In the Connected Devices columns, select a flashing Stage 16 slot to assign the selected Stage 16 to that slot.

 You can also right-click on the desired Stage device in the Available Devices column and assign it by selecting an available slot.



Flashing Stage slots in the Connected Devices column (left) and a Stage 16 assigned to Stage slot 2 (right)

The Stage slot is populated with the selected Stage 16, and the I/O on that Stage 16 is now available to be patched to system input and output channels in the VENUE Patchbay under the corresponding Stage 1–6 hardware tab. For more information on using the Patchbay, see the *VENUE S6L System Guide.pdf*.

- 7 Assign any other available Stage I/O racks as desired.

 You can reassign Stage I/O units at any time after initial software installation, and after all necessary firmware updates are completed. If you are replacing Stage units with one of a different type, simply select and Disconnect the unwanted Stage I/O unit in the Connected Devices list, re-assign the corresponding Stage slot if necessary, then assign the desired Stage I/O units.

Removing a Stage I/O Rack

You can unassign a Stage I/O rack from your configuration. Do this if you are removing a connected Stage device from your configuration, or if a Stage device from a previous configuration is not connected and you want to dismiss warning dialogs.

To remove a Stage device from the current configuration:

- 1 Put the system into Config mode.
- 2 Go to Options > Devices.
- 3 Do either of the following depending on the status of the Stage device:
 - To remove a connected Stage device, select that device in the Connected Devices column and choose Disconnect.
 - To remove a Stage device that is not connected (indicated by a greyed-out Stage device in the Connected Devices list), touch and hold (right-click) the greyed-out Stage device and choose Forget missing Stage device.

The I/O for that Stage device is now grayed-out under the corresponding Stage 1–3 hardware tab in the Patchbay.

Managing S6L–E6L Connections in Shared I/O Configurations

After the initial setup, the next time you power on your S6L system an S6L will automatically attempt to reconnect to the most recently assigned E6L. This allows for a specific S6L to always be paired with a specific E6L. The command Forget Engine is provided to manage subsequent S6L–E6L connections.

Forget Engine Lets you disconnect the currently connected E6L from the S6L control surface. This command is useful if you have multiple E6Ls and S6Ls that may or may not be used together regularly.

To disconnect an E6L from an S6L:

- 1 Enable Config Mode (see [Enabling Config Mode](#)).
- 2 Go to the Options > Devices page.
- 3 Right-click the E6L Engine graphic and choose Forget Engine.

On subsequent restarts, the S6L will not attempt to pair with any E6Ls on the network. Any pairings to an E6L must be made manually (see [Pairing the E6L and S6L](#)).

Managing E6L–Stage I/O Connections in Shared I/O Configurations

After the initial setup, the next time you power on your system the previous Master/Slave relationships between Stage 64s and E6Ls are maintained. If the E6L Input Master for a given Stage 64 in the network is not detected or is lost, the following dialogs are presented on the other E6L:

Master Engine Not Detected Appears when the E6L Input Master in the previous configuration is either not powered on or is not connected.

Master Engine Lost Appears if the E6L Input Master is disconnected from the network, for example if the audio network connection is broken or the Master E6L loses power.

In both cases, you can choose to either maintain the current Master/Slave relationship and continue to operate as if the Master E6L were still online (if, for example, the Master E6L has lost power), or become the Master of any Slave Stage 64s (if, for example, you do not expect the former E6L Master to come back online). If you choose the latter option, Stage 64s must be reassigned as described in [Reassigning a Stage I/O Rack](#).

Reclaiming Output Slot Ownership

Disconnecting and reconnecting a Stage 64 or Stage 32 from/to the Input Master system lets you choose whether to recall the previous ownership assignments, or to claim all Output slots.

When reconnecting the same Stage 64 or Stage 32 to the same Stage slot on the Input Master system, a dialog appears that lets you choose to either recall Output ownership from the previous configuration, or to claim the Stage Rack as a new Stage Rack and claim all Output slots by the Input Master system.

Choose either of the following in the Reconnecting Shared Stage Rack dialog:

Yes Connects the Stage Rack and restores Output slot ownership assignment to match the previous configuration.

No Connects the Stage Rack and claims all Output slots.

Show File Compatibility

Loading Show files is unaffected by Output ownership, and functions the same as when loading Show files onto systems configured for Shared Stage Input.

How to Proceed

To get started learning how to use the control surface, see any of the following:

- [Banking Channels on the S6L Control Surface](#)
- [Selecting and Attentioning Channels](#)
- [Adjusting Channel Parameters](#)

For overviews of the system components, see any of the following:

- [S6L Control Surface Overview](#)
- [E6L Engine Overview](#)
- [Stage and Local I/O Rack Overview](#)

To learn more about the external VENUE software screen, see [External VENUE Software Screen Overview](#).



The S6L system comes pre-loaded with Demo show files, which offer preset system configurations for some of the most common mixing scenarios. See [Loading a Show](#) for instructions on loading Show files.

Banking Channels on the S6L Control Surface

This chapter covers banking system channels to the channel strips on the S6L control surface, spilling Auxes, Groups and VCAs, creating and using custom fader layouts (User Layouts), and using Bank Safe.

Channel Banking Overview

The Master Live Module (MLM) provides channel *banking* controls to navigate to channels beyond the number of available physical channel strips. The banking controls on the S6L control surface let you:

- Bank a combination of input and output channels (see [Banking a Combination of Inputs and Outputs](#))
- Bank only custom fader layouts, VCAs, input channels, or output channels (see [Banking Only User Layouts, VCAs, Inputs, or Outputs](#))
- Create and recall custom fader layouts (see [User Layouts](#))
- Bank Safe channels, letting you “lock” channels to a fader (see [Bank Safing Channels](#))

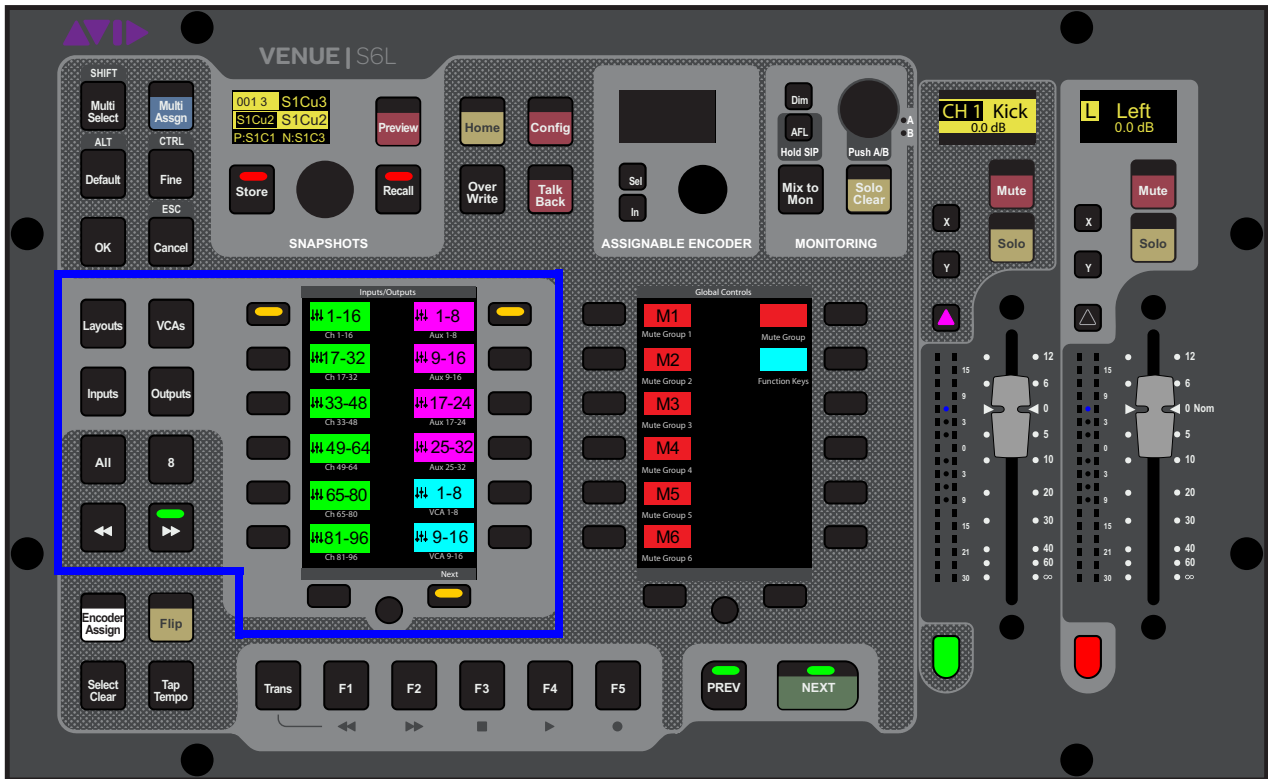

Banking controls on the MLM

💡 You can also bank channels to the external screen fader strips using on-screen tabs and buttons. See [Viewing Pages and Tabs](#). Banking channels on the external screen is independent of control surface banking.

Banking a Combination of Inputs and Outputs

Split Banking Mode

Split Banking mode, the default banking mode for the S6L control surface, lets you bank a combination of input and output channels to the S6L channel strips using pre-defined banks of channels. Split Banking mode banks input channels sequentially to the faders below the Channel Knob Modules (CKMs), and banks output channels sequentially to the faders below the Master Live Module (MLM). The Left Soft Keys menu shows the pre-defined channel banks, which you bank to the faders using the corresponding Soft Keys. Multiple pages of channels banks are provided, which you can navigate using the Left Soft Keys display navigation switches.

Navigating the Left Soft Keys Display in Split Banking Mode

Split Banking mode provides multiple pages of channel banks you can choose to bank to the faders. The Previous and Next Page switches, and the Home switch let you navigate the available pages of channel banks.

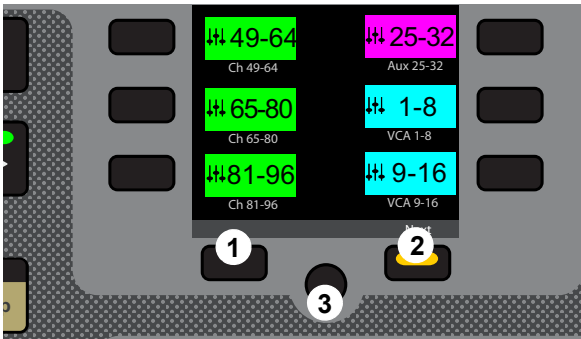

Left Soft Keys display navigation switches

1 – Previous Switch

2 – Next Switch

3 – Home Switch

To access to the previous or next page of available channel configurations:

- Press a lit Previous or Next switch until you locate the channels you wish to access.
The switches are lit when there is a previous or next page of channel configurations available.

To return to the first page of available channel configurations:

- Press the lit **HOME** switch.

Banking Inputs in Split Banking Mode

In Split Banking mode, input channels appear in the left-hand column of the Left Soft Keys display. The S6L-32D provides 24 input channels per bank, S6L-24D/24C provide 16 input channels per bank, and S6L-16C provide 8.

To bank input channels in Split Banking mode:

- 1 Make sure the Layouts, VCAs, Inputs, or Outputs switches are unlit/not selected. If one is selected, press it so it is unlit.
- 2 In the left-hand column of the Left Soft Keys display, locate the input channels you want to bank to the faders.
 - Or press the lit Next switch until you see the desired channel configuration in the display.

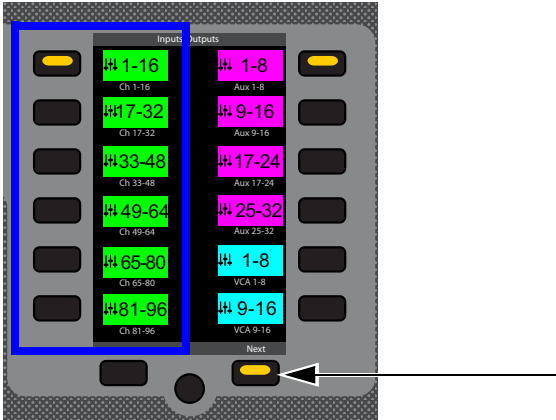

Left Soft Keys display showing the first page of Split Banking mode channel configurations, and a lit Next switch

- 3 Press the corresponding Soft Key so it lights. The selected set of input channels are banked to the faders below the CKMs.

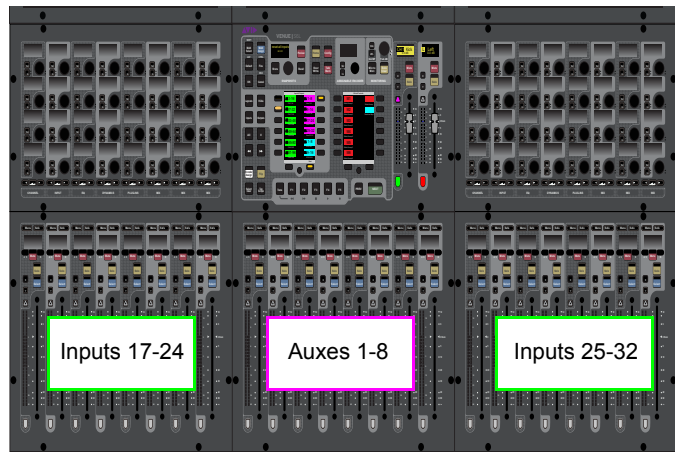
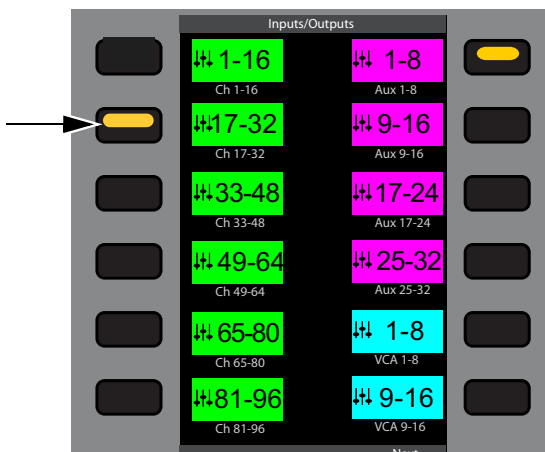

The selected Soft Key (left) and how the selected configuration of channels is banked to faders of an S6L-24D (right)

On S6L-24C, the MLM is at the far right above faders 17–24. Banking to input channels 17–32 on 24C places those channels on faders 1–16.



Selected configuration of channels banked to fader on S6L-24C

Banking Outputs in Split Banking Mode

In Split Banking mode, outputs channels appear in the right-hand column of the Left Soft Keys display. All S6L control surface models provide eight output channels per bank. The type and number of Aux and Group output channels available for banking depend on the overall Mix Bus configuration as set in the Options > System page of the external screen.

To bank output channels in Split Banking mode:

- 1 Make sure the Layouts, VCAs, Inputs, or Outputs switches are not selected (unlit). If one is selected, press it so it is unlit.
- 2 In the right-hand column of the Left Soft Keys display, locate the output channels you want to bank to the faders.
 - Or press the lit Next switch until you see the desired channel configuration in the display.

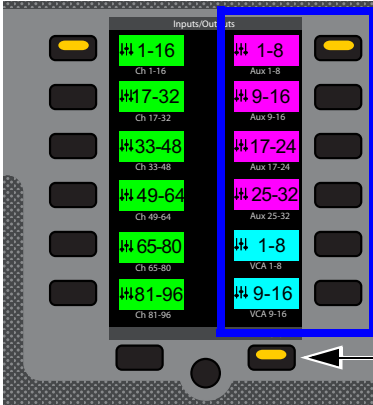

Left Soft Keys display showing the first page of Split Banking mode channel configurations, and a lit Next switch

- 3 Press the corresponding Soft Key so it lights. The selected set of output channels are banked to the faders below the MLM.

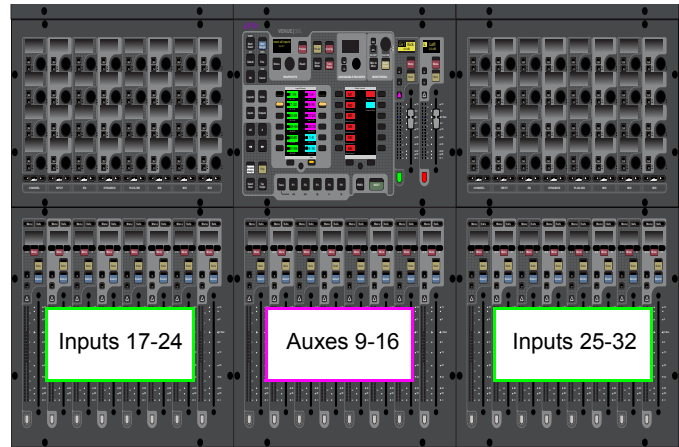
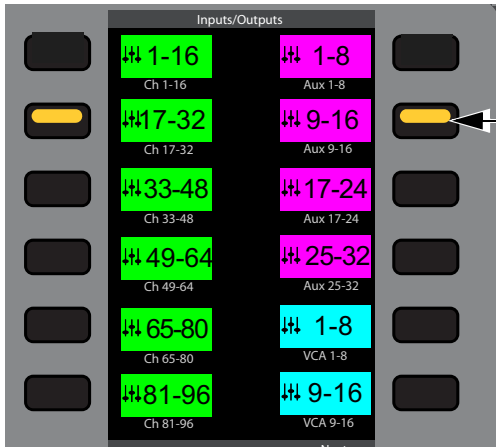

The selected Soft Key (left) and how the selected channels are banked to faders of an S6L-24D (right)

On S6L-24C, banking to Auxes 9–16 places those channels on faders 17–24 and on S6L-16C to faders 9–16.



Selected configuration of channels banked to fader on S6L-24C

Banking Only User Layouts, VCAs, Inputs, or Outputs

Fader Bank Mode

You can bank only certain types of channels to the faders using the Fader Bank Mode switches. Pressing a Fader Bank Mode switch banks only the selected type of channels to all faders on the control surface. The Left Soft Keys display shows the available banks of channels, which you bank using the corresponding Soft Keys. You can also use the Horizontal Banking switches to nudge the currently banked channels.

To bank a User Layout in Fader Bank mode:

- Press **Layouts** so it lights.

If you have not created your own custom User Layouts, the default User Layout is banked to all faders on the control surface.

 For instructions on creating your own User Layouts, see [User Layouts](#).

To bank VCAs in Fader Bank mode:

- 1 Press the **VCA** Fader Bank mode switch so it lights.

VCAs 1–16 (S6L-16C), 1–24 (S6L-24D/24C), or 1–32 (S6L-32D) are banked to all the faders on the control surface.

- 2 To bank to other VCAs, such as VCAs 25–32 on the S6L-24D/24C, press the corresponding Soft Key.

- Or use the Horizontal Banking switches to nudge channels left or right (see [Banking Horizontally \(Nudging Channels\)](#)).

 If you navigate out of Fader Bank mode, the next time you enable Fader Bank mode the previous banking configuration will be recalled for the selected channel type.

To bank input channels in Fader Bank mode:

- 1 Press the **Inputs** Fader Bank Mode switch so it lights.

Input channels 1–16 (S6L-16C), 1–24 (S6L-24D/24C), or 1–32 (S6L-32D) are banked to all the faders on the control surface.

- 2 In the Left Soft Keys display, locate the input channels you want to bank to the faders. Only input channels are shown in the display.

- 3 Press the corresponding Soft Key to bank the desired channels to all faders on the control surface.

- Or use the Horizontal Banking switches to nudge channels left or right.

To bank output channels in Fader Bank mode:

- 1 Press the **Outputs** Fader Bank Mode switch.

Auxes 1–16 (S6L-16C), 1–24 (S6L-24D/24C), or 1–32 (S6L-32D) are banked to all the faders on the control surface.

- 2 In the Left Soft Keys display, locate the output channels you want to bank to the faders. Auxes, Groups when applicable, Matrixes, and Mains are shown in the display.

- 3 Press the corresponding Soft Key to bank the desired channels to all faders on the control surface.

- Or use the Horizontal Banking switches to nudge channels left or right.

To exit Fader Bank mode, do any of the following:

- Press a lit Fader Bank Mode switch. The last Split Banking mode channel configuration is restored to the faders.
- Press **Home**.

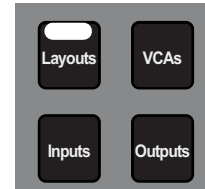

Fader Bank mode switches

Banking Horizontally (Nudging Channels)

The Horizontal Banking switches, available when Fader Bank mode is enabled, let you sequentially nudge channels to the left or right one channel at a time, one fader bank (eight channels) at a time, or all fader banks (16 channels for S6L-16C, 24 channels for S6L-24D/24C, or 32 channels for S6L-32D) at a time. When Fader Bank mode is enabled, depending on the type of channels currently banked to the faders, the << and/or >> switches light to indicate the direction in which you can nudge channels.



Horizontal Banking switches

To nudge channels to the left or right by one channel:

- Press a lit << or >> switch. The Soft Keys LEDs for the active banks of channels flash to indicate that channels from both banks are contributing to the current banking configuration.

To nudge channels to the left or right one fader bank (eight channels):

- 1 Press the **8** switch so it lights.
- 2 Press a lit << or >> switch. The Soft Keys LEDs for the active banks of channels flash to indicate that channels from both banks are contributing to the current banking configuration.

To nudge channels to the left or right 24 (for S6L-24D/24C) or 32 (for S6L-32D) channels:

- 1 Press the **All** switch so it lights.
- 2 Press a lit << or >> switch. The Soft Key LED for the next or previous bank of channels lights to indicate that those channels are banked to the control surface's faders.

Spill Mode for Outputs

Spill mode lets you rapidly access channels assigned to an Aux or Group output bus, Matrix, or VCA, without needing to navigate through fader banks on the console. Spill mode can be activated from the fader strip for an Output master, or from Universe view.

To spill from the Output strip:

- Double tap the attention key of the desired Aux, Group, Matrix, or VCA.

To spill from the Universe view:

- 1 Navigate the MTS (or external screen on S6L-16C) Universe view to the Matrix, Auxes, Groups, or VCAs page.
- 2 Tap to enable the Spill icon.
- 3 Touch an Aux, Group, Matrix, or VCA tile. The members of that output are spilled to the faders.



You can control how the spilled master is or isn't banked when spilling using the [Position Safe When Spilling](#) setting.

- 4 When an output is spilled, attentioning any other Output spills that output.



For Auxes, see also [Adjusting Aux Sends on Faders \(Sends on Faders Mode\)](#).

To exit (unspill), do any of the following:

- Press the attention key of the spilled output.
- Select a fader Banking mode (such as Inputs, Outputs, Layouts, or VCAs).
- On the MLM, press Spill so it is disabled (or press Cancel).
- Press Exit Spill on the external GUI banner.

User Layouts

You can create custom fader Layouts and access those channels on the S6L channel strips using the **Layouts** switch and left Soft Key bank on the MLM, providing the following features and capabilities:

- Store a single Layout in a snapshot (as available in previous versions of VENUE software).
- Save up to 23 additional Layouts within a single Show file, and assign Layouts to MLM Soft Keys, separate from snapshots.
- Name, recall and edit Layouts.

User Layouts can include any type of channel in any order of any format, up to the maximum number of fader strips on the control surface (such as 16 on S6L-16C, 24 on S6L-24D/24C and 32 on S6L-32D). Each User Layout can be saved as a discrete User Layout preset file. You can also store and recall one User Layout per snapshot.

Assigning Channels to a User Layout

You can assign channels to a User Layout using the S6L control surface or the external screen. You can assign individual channels or multiple channels using Multi-Assign. Channels are arranged from left to right in the User Layout in the order in which they are assigned. You can then reorder them using drag-and-drop (see [Reordering Channels Using Drag and Drop](#)).

Clearing a User Layout

When you first launch an S6L system, or load a Demo Show file included with the system, the default User Layout (Layout 1) is loaded. You may want to clear the default User Layout before creating your own.

To clear the default User Layout

- 1 On the external screen, go to the Inputs or Outputs page and select the **Layouts** tab. Make sure the default User Layout (Layout 1) is either recalled or selected in the list.
- 2 Tap-and-hold (right-click) any fader strip and select **User Layout** from the pop-up menu, then choose **Reset Layout**.
 - Or, select the Gear icon under the User Layout members list and choose **Clear** from the menu. If Layout 1 is selected, choose **Reset to Default**.

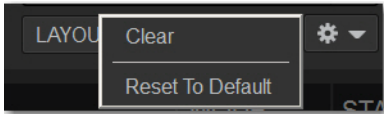

Layouts Gear icon menu

Creating Layouts Using the S6L Control Surface

To create and assign Layouts using the MLM Soft Keys:

- 1 On the MLM, press the **Layouts** switch.
The last recalled Layout (or the default Layout if no custom Layouts exist) banks to all faders on the control surface.
- 2 Press and hold a Soft Key for two or more seconds. In the image at right, Soft Key 1 (Layout 1) is selected.
The Channel Color switch under fader strip 1 flashes red, indicating it is ready for channel assignment.
To choose a different fader strip for assignment, press its Channel Color switch so it flashes red.
- 3 To select a channel to assign to the currently targeted fader strip, do either of the following:
 - Tap a channel tile in the Universe of the MTS. The channel tile is bordered in orange.
 - Press a channel **Attention** switch.The Channel Color switch on the next fader strip flashes red.

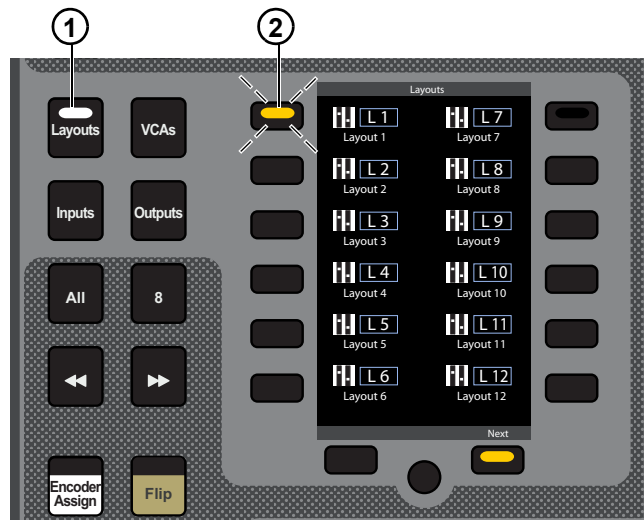

- 4 Repeat the previous steps to assign additional channels to fader strips.
- 5 When finished, do any of the following:
 - To save the Layout and exit Layout Assign mode, tap OK on the MTS or external screen.
 - To save the Layout but remain in Layouts Assign mode, press a different Layouts Soft Key.
 - To exit without saving the new Layout, tap Cancel on the MTS or external screen.

To navigate the Soft Keys to other Layouts:

- Press the Prev or Next Soft Keys below the Left Soft Keys bank.

Creating Layouts Using the Universe View

To assign channels to the User Layout using the Universe view:

- 1 On the MTS (or external screen on S6L-16C), touch Universe to show the Universe view.
- 2 Tap LAYOUT ASSIGN so it lights. The S6L system enters User Layout Assignment Mode. Channels assigned to the current or most recently selected User Layout are indicated on the control surface as follows:
 - Channel Tiles for the currently assigned channels are bordered in orange on the MTS.
 - **Attention** switches for currently assigned channels flash.

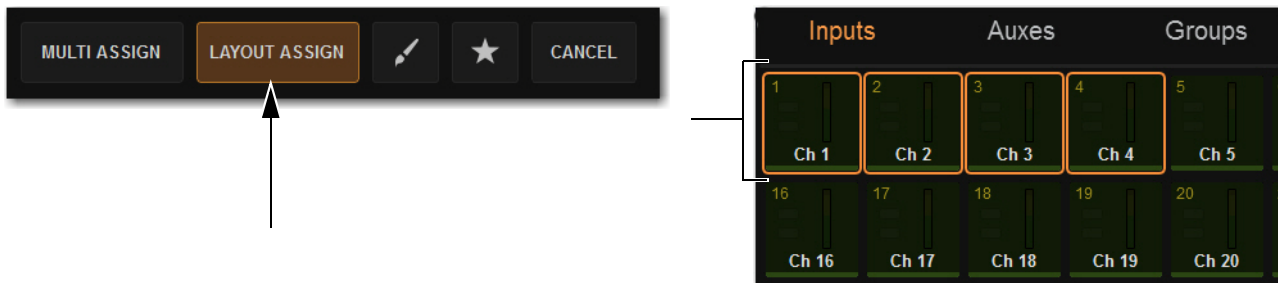

Enabled Layout Assign button (left) and Channel Tiles showing channels currently assigned to the User Layout

- 3 Tap a Channel Type button (Inputs, Auxes, Groups, Matrixes, VCAs, or Mains) to show those channels on the MTS, or Bank the desired channels to the channel strips.
- 4 Tap a channel tile. The channel tile is bordered in orange.
 - or –
 - Press a channel **Attention** switch. The Attention switch flashes.
- 5 Repeat to assign any other channels, navigating to other channel banks as necessary.
- 6 To remove a channel from the User Layout, do either of the following:
 - Tap a Channel Tile that is bordered in orange so the orange border disappears.
 - Press a channel **Attention** switch so it is no longer flashing.
- 7 Tap Layout Assign (or press **Multi-Assign** on the MLM) so it is unlit to exit User Layout Assignment mode. Your User Layout assignments are saved.
- 8 If desired, store the User Layout as a Preset. See [Working with User Layout Presets](#).

Creating and Editing Layouts Using the External Screen

To assign a channel to a User Layout using the external screen:

- 1 Depending on the type of channel you want to assign, go to the Inputs or Outputs page.
- 2 Touch and hold (right-click) a fader strip on-screen, and select User Layout from the pop-up menu.
- 3 In the User Layout sub-menu, choose the channel strip to which you want to assign the channel.

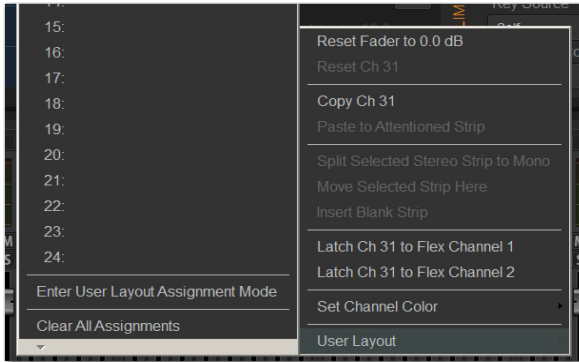

User Layout sub-menu

- 4 Repeat for any other channels you want to assign.
- 5 If desired, store the User Layout as a Preset. See [Working with User Layout Presets](#).

To remove channels from a User Layout using the external screen.

- 1 Go to the Inputs or Outputs page.
- 2 Select the Layouts tab.

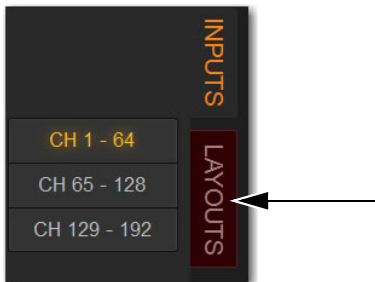

External screen Layouts tab (right)

- 3 To remove a single channel from a User Layout:
 - Tap-and-hold (right-click) any fader strip and select User Layout from the pop-up menu.
 - Choose Clear Chanel <x>: <channel name>.

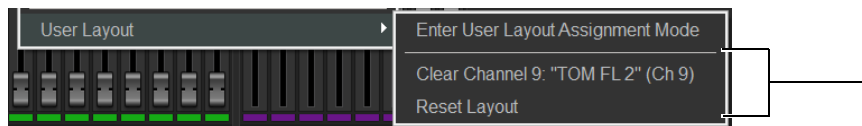

Clear User Layout Assignments menu items

To reset a User Layout:

- Do either of the following:
 - Tap-and-hold (right-click) any fader strip, select User Layout from the pop-up menu, and then choose Reset Layout.
 - Select the Gear icon under the User Layout members list and choose Clear from the menu. If the default User Layout (Layout 1) is currently recalled or selected in the list, choose Reset to Default.

Banking the User Layout

You can bank the User Layout from the control surface or the external screen.

To bank User Layouts to the channel strips on the control surface:

- 1 On the MLM, press the **Layouts** Fader Banking Mode switch.
The last recalled Layout (or the default Layout if no custom Layouts exist) banks to all faders on the control surface. The left bank of MLM Soft Keys display all available User Layouts.
- 2 Press a Soft Key to bank the corresponding User Layout.

Channels assigned to the current User Layout are banked to the channel strips. User Layout strips that have no channel assignments are blank. Any stereo channels are assigned to a single fader, as are the three Mains buses (see [Using Mains in a User Layout](#)).

Working with User Layout Presets

You can store the current User Layout to disk as a preset file. One User Layout is stored to a preset file. You can then load a User Layout saved as a preset file. After you load a preset file, you can then bank the newly loaded User Layout.

To store a User Layout as a preset file:

- 1 Assign channels to the User Layout as desired.
- 2 On the external screen, go to the Inputs or Outputs page and select the LAYOUTS tab.
- 3 Below the User Layout Members list, select the Presets Folder icon on-screen to open the User Layouts Presets Folder.

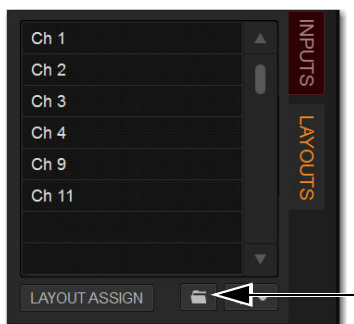

User Layout Presets folder icon

- 4 Choose User Presets folder from the Folder pop-up menu at the top of the Presets window.

To store the current User Layout as a new preset:

- Select **New** and enter a name for the preset file. The current User Layout is stored as a User Layout preset.

To preview an existing preset:

- Select the preset name in the Presets window so it is highlighted. The selected User Layout is visible on the external screen Layouts tab, but is not yet loaded.

To load the currently selected preset:

- Press **Enter** on the keyboard or press **OK** in the Presets window title bar.

To immediately load a preset and close the Presets window:

- Double-tap the preset.

To cancel without loading the preset.

- Select **Cancel**.

Examples of Creating and Editing Layouts

The following two examples show how to create a Layout that includes blank strips, and how to modify an existing Layout by removing three assigned channels.

Example 1: Creating a Layout with Blank Strips

The following example shows how to create and save a custom Layout consisting of channels 1–8, 8 blank strips, and channels 9–16. This custom Layout will be assigned to MLM Soft Key 2.

To create and store Layouts:

1 Select **Layouts** Fader Banking Mode.

2 Press and hold Layout Soft Key **2** for two or more seconds.

The Layout already assigned to Soft Key 2 loads, the Channel Color switch on fader strip 1 flashes red, and Layout Soft Key 2 flashes. If no Layout is assigned to the selected Soft Key, an empty Layout is recalled (all faders darken and move to $-\infty$),

3 Select Channel 1 on the MTS.

Fader strip 1 populates with Channel 1, and the Channel Color switch on fader 2 flashes red indicating it is ready for channel assignment.

4 Repeat Step 3 to assign channels 2–8 to fader strips 2–8.

5 Press the Channel Color switch on fader 17.

The Channel Color switch on fader 17 flashes red.

6 Repeat Step 3 to assign channels 9–16 to fader strips 17–24.

7 On the MLM, press OK.

The new Layout is stored to Soft Key **2**, and the Soft Key **2** switch LED lights solid indicating it is the currently loaded Layout. On the external screen, the Layouts tab shows the currently loaded Layout.

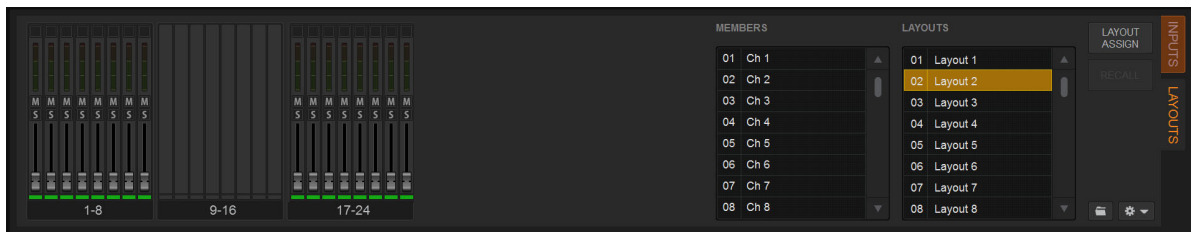

Layouts view showing channels assigned to faders 1-8 and 17-24

Modifying a Custom Layout

The following example shows how to modify an existing custom Layout assigned to Soft Key 6, to clear faders 9, 10, and 11.

To modify a stored custom Layout:

1 Select **Layouts** Fader Banking Mode.

2 Press and hold Layout Soft Key **6**.

Faders populate with Layout 6. The Channel Color switch on fader strip 1 flashes red, and Layout Soft Key 6 flashes.

3 Press and hold the Channel Color switch on fader strip 9.

Fader strip 9 clears (it darkens and its fader resets to $-\infty$), and its Channel Color switch flashes red.

4 Repeat Step 3 to clear fader strips 10 and 11.

5 On the MLM, press OK.

The modified Layout is stored to Soft Key 6 which lights solid.

Layouts View

The Layouts tab is available at the bottom of the Inputs, Outputs, and Snapshots views. Enabling the Layouts tab displays the following controls for assigning, recalling, and managing Layouts.

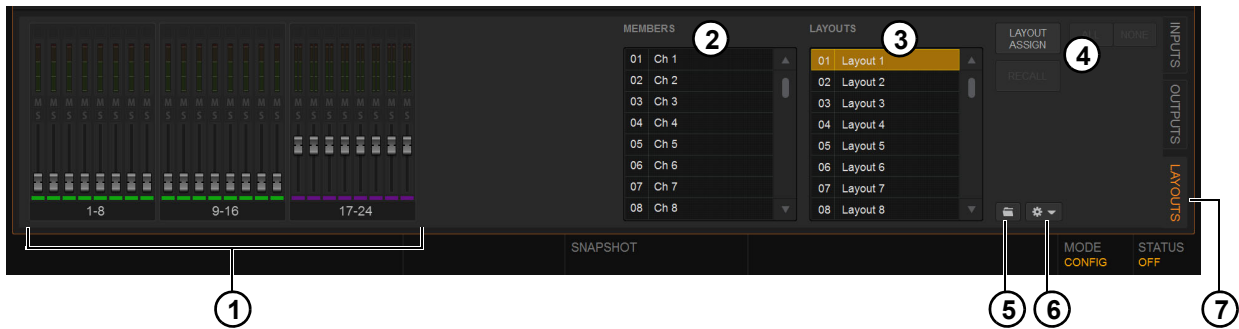

Layouts tab

1 – Fader Strips

These strips correspond to all available fader strips on the control surface (32 on S6L-32D control surfaces, 24 on S6L-24D, or 16 on S6L-16C).

2 – Members

This scrollable display lists all channels assigned to the currently loaded Layout, or those assigned to the Layout currently targeted in the Layouts list.

3 – Layouts List

This scrollable display lists the default Layout and all 23 available Layouts. To recall a Layout, click to select it (it lights red, indicating it is targeted), then click the Recall button. Channels assigned to the Layout appear in the Members list.

To rename a Layout:

- Double-click its name in the Layouts List.

Similar to the Snapshots list, the Layouts list shows the currently loaded Layout in green. Selecting a different Layout in the list targets that Layout (it turns red) and its members appear in the Members list.

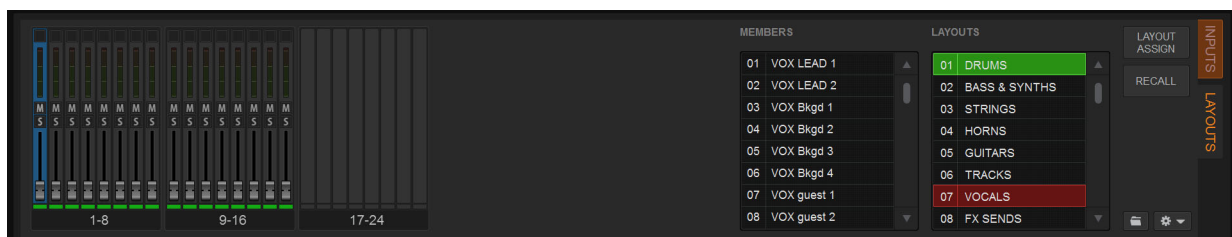

Layouts tab showing the current Layout (01 DRUMS) and a targeted Layout (07 VOCALS)

4 – Layout Assign and Recall

These switches enable Layout Assign mode and Recall the currently targeted Layout, respectively.

5 – Layouts Presets

This icon lets you create, preview, and load User Layout Presets.

6 – Layouts Options (Gear Menu)

This menu provides commands to manage Layouts, including Assign to Soft Key, Replace with Layout From, Auto Assign all Soft Keys, Clear all Soft Keys, Clear, and Reset to Default.

Commands in the Layouts Options (Gear menu)

Command	Function
Assign to Soft Key	Assign the currently targeted Layout to any of the 24 available Layouts Soft Keys
Replace with Layout From	Replaces the currently targeted Layout with channel assignments from the selected Layout
Auto Assign all Soft Keys	Assigns all Layouts 1–24 to corresponding Layouts Soft Keys 1–24
Clear all Soft Keys	Clears all Layout assignments from Soft Keys
Clear	Clears all channels assigned to the currently targeted Layout
Reset to Default	Resets Layout 1 to its default assignments

7 – Layouts Tab

Selecting this tab displays Layouts view across the bottom of the external screen.

Layouts, Snapshots and Show Files

The following sections describe how Layouts are managed within Show files and snapshots.

Using Layouts in Snapshots

You can store and recall one User Layout per snapshot, providing up to 999 User Layouts per Show file. As with other snapshot data types, the current User Layout and the associated parameters (mute, solo, etc.) are stored whenever you store a snapshot. However, because Layout 1 is associated with the current snapshot, updating that Layout is not automatically saved into the snapshot. Be sure to store the associated snapshot after creating or editing the desired Layout.

Recalling a Snapshot with the LAYT Data Type button scoped recalls the User Layout stored in the snapshot (see [Recalling Snapshots](#) for more information).

The single Layout that is stored in a Show file created in an earlier version of VENUE software, and/or snapshot is always assigned to MLM Soft Key 1. In addition:

- Any Layout currently stored in a Show file remains stored in the file as Layout 1.
- Any Layout currently stored in a snapshot remains stored in the snapshot as Layout 1.
- Storing a snapshot stores Layout 1.
- Recalling a snapshot with LAYT scoped updates Layout 1, but does not force a Recall of Layout 1.
- While in any Fader Banking mode other than Layouts, when a snapshot is recalled with LAYT scoped the current Fader Banking mode is maintained. If you then enter Layouts Fader Banking Mode, faders will update to the Layout in the currently loaded snapshot (Layout 1).
- Additional Layouts that are stored to Soft Keys are stored in the currently loaded Show file (not the Presets folder).
- Soft Key Assignments are stored in the Show file (not the Presets folder).

Using Mains in a User Layout

When you assign Mains L-R + C/Mono to a User Layout, a single fader for all three Mains buses is assigned to the Layout regardless of the Mains buses' linked/unlinked state. When Mains are linked, adjusting the fader in the User Layout controls levels for the linked Mains buses. See [Using Mains in a User Layout](#) for more information.

Bank Safing Channels

Bank Safe lets you temporarily “lock” the location of key channels (such as a lead vocal or the Mains) on an S6L control surface channel strip. This lets you maintain immediate access to these key channels while working with channels on a different layer. When a channel is removed from Bank Safe, the channel that would normally appear in that fader location on the currently selected bank automatically re-appears.

You can Bank Safe channels using the Channel Safe switches, the Channel Knob Module (CKM) in Channel Control mode, or the Channel Menu. To Bank Safe channels using the Channel Safe switches, you must first enable Bank Safe mode.

Bank Safing Using the Channel Safe Switches/Button

The Channel **Safe** switch on the S6L control surface and the Channel Safe button on the external software screen toggle Bank Safe for that channel when Bank Safe mode is enabled. Bank Safe Mode is enabled globally for input and output channels on the Options > Interaction page of the external screen.

To enable Bank Safe for the Channel Safe switches:

- 1 On the external screen, go to the Options > Interaction page.
- 2 In the Channel Safe Switches Inputs and Outputs sections, select Bank Safes as desired.



You can create an event that lets you cycle through the various Channel Safe switch modes, suspend or disable Bank Safe (Disable Bank Switch). See [Creating Events](#).

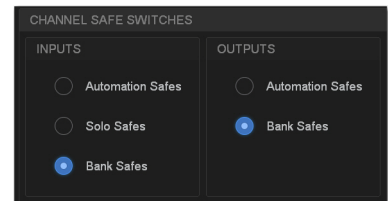

Channel Safe Switch options in the Options > Interaction page

To Bank Safe channels using the Channel Safe switches:

- 1 Make sure you have enabled Bank Safe for the Channel Safe switches.
- 2 On the S6L control surface, do the following:
 - Bank the desired channel to the faders.
 - Press **Safe** for the channel you want Bank Safe.



S6L Channel Safe switch engaged

- 3 On the external screen, do the following:
 - Go to the Inputs or Outputs page, and navigate to the desired channel using the provided tabs and buttons.
 - Select the Channel Safe switch for the desired channel, located at the top of each fader strip.

Bank Safe status for the channel is indicated as follows:

- On the control surface channel strip, the **B** LED lights red.
- In the Input section of the MTS and CTM Channel view for the channel, **B** lights red.
- On the external screen the Safe button flashes green and shows the letter B (A appears if the switch is acting as an Automation Safe, and S appears if it is acting as a Solo Safe).

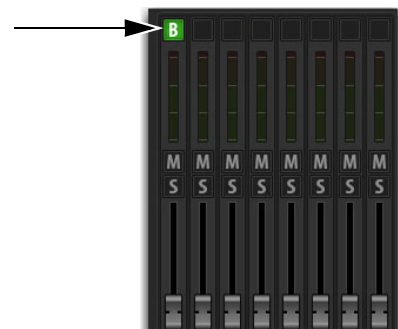
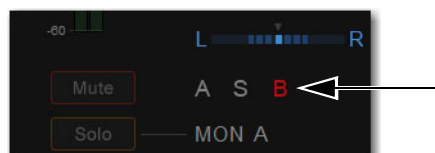
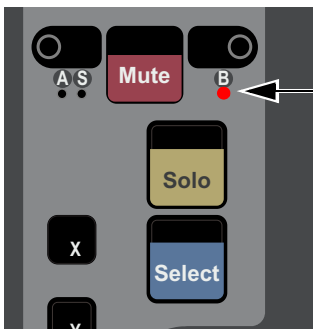

Indications that a channel is Bank Safed on the channel strip (left) the MTS/CTM Channel view (center) and on the external screen (right)

Bank Safing Using the Channel Knob Module (CKM)

You can Bank Safe a channel using the CKM in Channel Control mode. You can Bank Safe a channel using the CKM when a different Safe mode (such as Automation and/or Solo Safe) is enabled for the Channel Safe switches.

To Bank Safe a channel using the CKM:

- 1 Bank the desired channel to the faders.
- 2 Press the **Select** switch for the channel you want Bank Safe so it lights, then press the **INPUT** Channel Control Function switch so it lights.

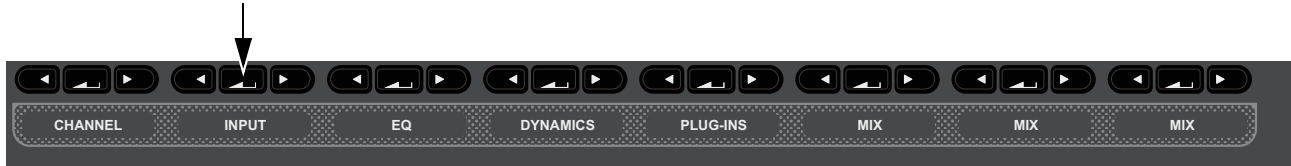

CKM Channel Control Function Switches

– or –

- Touch the channel's Input touch zone on the associated Channel Touch Module (CTM). Input parameters are assigned to the associated CKM.

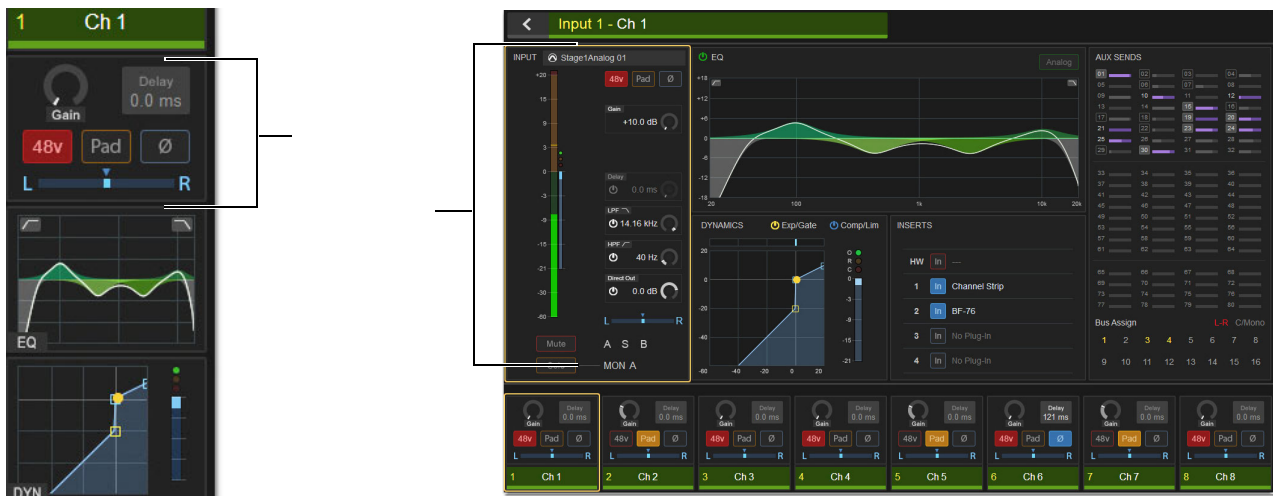

Input touch zone on the CTM in Meters view (left) and in Channel view (right)

- 3 Locate the Bank Safe encoder, indicated by Bank Sf on the encoder display, and press the encoder. The encoder **In** switch lights green, and the channel is Bank Safed.



Bank Safe parameter on a CKM encoder

Bank Safing Using the Channel Menu

You can Bank Safe a channel using the Channel Menu when a different Safe mode (such as Automation and/or Solo Safe) is enabled for the Channel Safe switches.

To Bank Safe a channel using the Channel Menu:

- 1 Bank the desired channel to the faders.
- 2 Press the **Menu** switch for the channel you want to Bank Safe until **Safe Mode** appears in the channel display. The Safe modes enabled by the Left and Right Channel Menu switches are shown below **Safe Mode**.
- 3 Press the Right Channel Menu Switch so it lights to Bank Safe the channel. The **B** LED lights red.

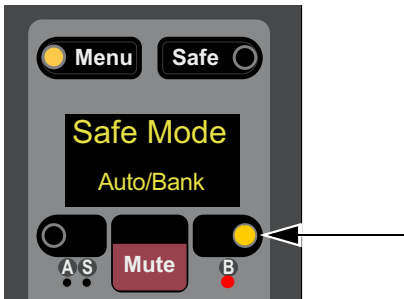

Right Channel Menu switch engaged

Special Cases Affecting Bank Safe

Reordering/Moving Channels

Bank Safed channels shuffle accordingly when any operation is performed that results in a re-ordering of input channels, including the following:

- Inserting or Removing a Blank Strip
- Moving a strip
- Splitting a stereo strip(s)
- Opening a Show file that was saved on a VENUE system that used a different control surface layout than S6L.

Make Stereo

The Bank Safe status of the left channel is applied to the newly created stereo channel.

Split Stereo

The Bank Safe status of the stereo channel is applied to only to the left channel of the former pair.

Selecting and Attentioning Channels

On the S6L system, there are two ways to target channels for processing, assigning, and other channel functions: *selecting* and *attentioning* channels. Selecting a channel *locally* selects that channel, and targets it to the associated Channel Knob Module (CKM). Attentioning channels targets channels to the external VENUE software screen and the Master Touch Screen (MTS, if present).

Selecting Channels

Selecting a channel lets you adjust the channel's parameters using the associated CKM. You can select channels using fader strip **Select** switches, using the associated Channel Touch Module (CTM) if available, or by enabling the **Select Follows Solo** setting.

Selecting a Channel Using the Select Switch

To select a channel using the channel strip **Select** switch:

- 1 Bank to the desired channels.
- 2 Press **Select** on the corresponding channel strip so it lights. The background of the display also lights yellow to indicate that the channel is selected.

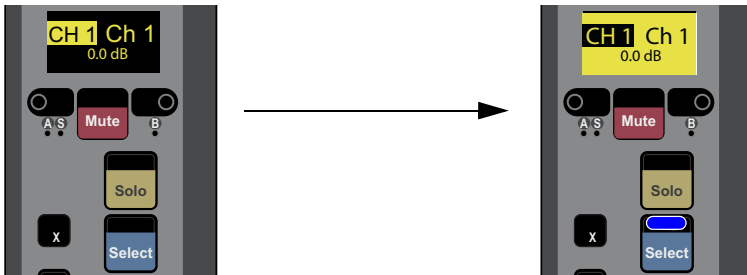

An unselected channel (left) and a selected channel (right)

Depending on the fader bank from which you selected the channel, you can adjust the selected channel's parameters from an associated CKM, as follows:

- On all models of control surface, selecting a channel on a fader bank *below* a CKM enables Channel Control mode on that CKM, as shown in the following figure on the left (S6L-24D shown).
- On S6L-32D/24D, selecting a channel on the fader bank below the Master Live Module (MLM) enables Channel Control mode on the CKM to the *right* of the MLM, as shown in the following figure on the right (S6L-24D shown).
- On S6L-24C or S6L-16C, selecting any channel enables Channel Control mode on the one CKM (above faders 1–8)



Selecting a channel below a CKM (left) and below the MLM (right) on an S6L-24D

Selecting a Channel From Meters View

You can select channels from the Meters view or Channel view on the MTS and CTMs (if any).

To select a channel while in Meters view:

- 1 Bank the desired channel to any fader bank except the fader bank under the MLM.
- 2 In Meters view, do any of the following:
 - Touch the Input, EQ, Dynamics, Plug-Ins, or Mix touch zone for the channel you want to select. That channel is selected, the touch zone is bordered in orange, and the parameters associated with the active touch zone are spilled to the associated CKM in Channel Control mode.

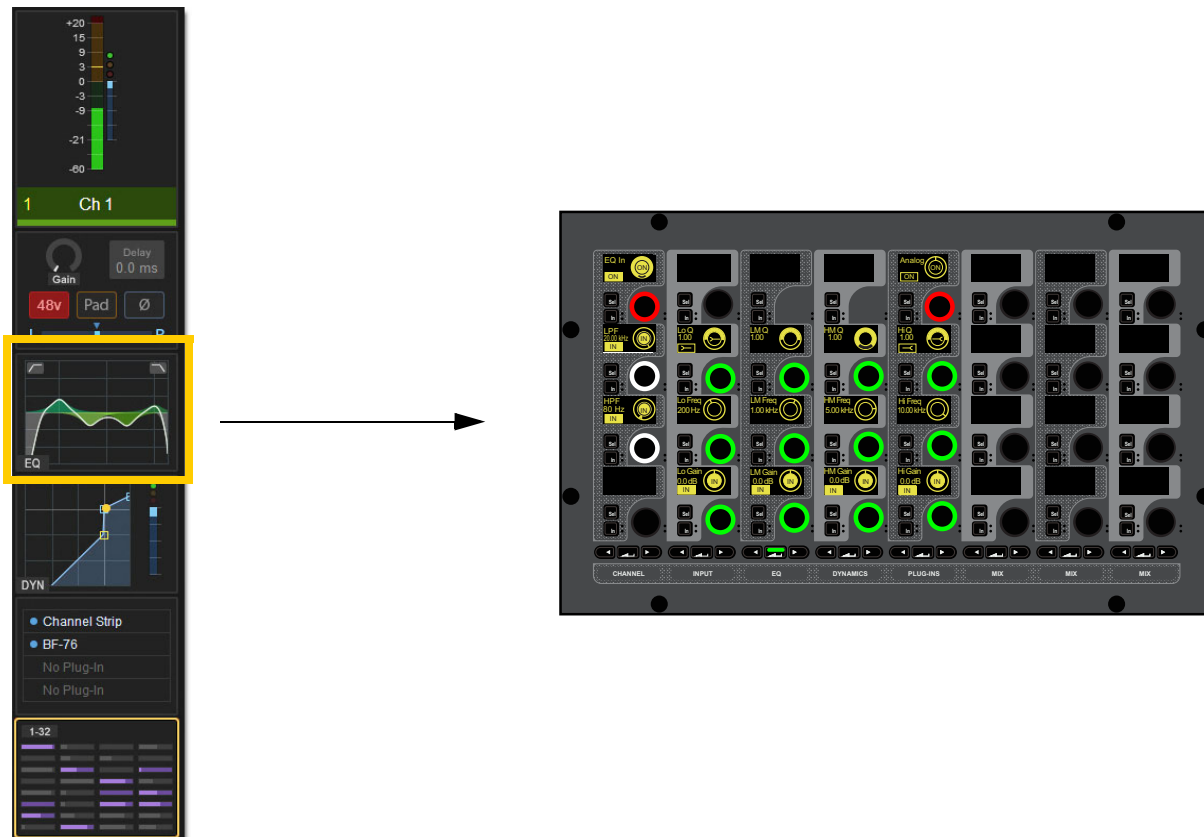

Selecting the EQ touch zone spills EQ parameters in Channel Control mode to the associated CKM in Channel Control mode.

- Or touch the channel's Meter touch zone.

The CTM (if any) switches to Channel view. The Channel Tile for the currently selected channel is bordered in orange, and the parameters associated with the last active Channel Control function are spilled to the associated CKM in Channel Control mode.

To select a different channel in Channel view:

- Touch a different Channel Tile at the bottom of the display. That channel is now selected, and the encoders on the CKM now target the selected channel.

 When using an S6L-24C control surface, an additional option becomes available in Options > Interaction. For more information, see [Meters Follow Selection \(S6L-24C Only\)](#).

Select Follows Solo

The setting Select Follows Solo is provided in the Channel Selection section of the Options > Interaction page. When enabled, engaging Solo on any channel that is currently banked to the faders also selects that channel. Solo can be engaged from the CFM, MTS, or external screen, but the channel must already be banked to the control surface to engage local Select.

Attentioning Channels

You can attention a channel using the channel strip **Attention** switches, the Universe view, or from the fader strips on the external screen. Attentioning a channel targets the channel to the Inputs or Outputs page of the external VENUE software screen, from which you can adjust channel parameters independently of selected channels. The attentioned channel is also targeted to the MTS Channel view (all systems except S6L-16C).

 *By default, selecting a channel also attention it. You can change this behavior to decouple Select and Attention by changing the **Attention Follows Select** preference in the Options > Interaction tab on the external screen.*

To attention a channel using the Attention switch:

- 1 Bank to the desired channels.
- 2 Press **Attention** on the corresponding channel strip so it lights. The channel display inverts (black text on a yellow background) with black borders above and below, distinguishing it from indication of channel Select.

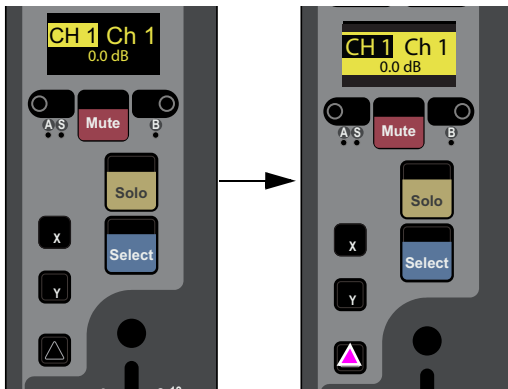

An unselected and unattentioned channel (left) and an attentioned channel (right)

On the MTS/Universe view, the channel tile is bordered in blue. On the external screen the fader lights blue.

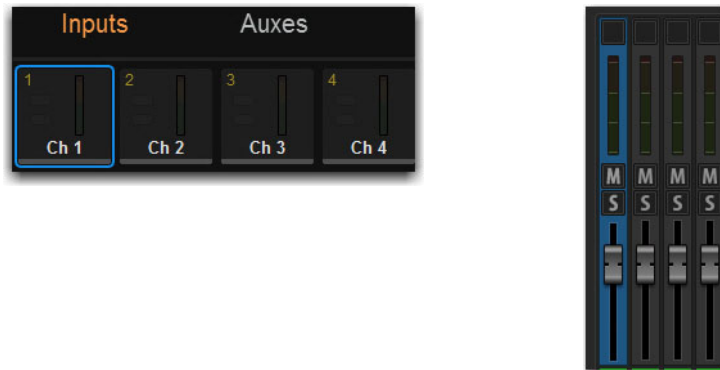

Indications of attentioned channels in the MTS (left) and on the external screen (right)

To attention a channel using the Universe view:

- 1 On the MTS or external screen (S6L-16C only) touch Universe to show the Universe view.
- 2 Touch the appropriate Channel Type button (Inputs, Auxes, Groups, Matrixes, VCAs, or Mains) to show the channel you want to attention.
- 3 Touch the Attention Channel Tile Function button so it lights.

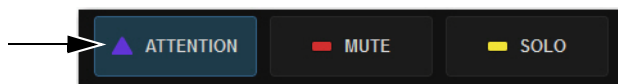

An enabled Attention Channel Tile Function button

- 4 Touch the channel tile. The channel tile is bordered in blue to indicate the channel is attentioned.

To view the attentioned channel in the MTS Channel view:

- Touch Channel. The currently attentioned channel's parameters are shown. When you attention another channel, its parameters are shown in the Channel view.

 For information on working with external screen controls, including attentioning channels, see [Adjusting Parameters on the External Screen](#).

Attention on Fader

Use the Attention on Fader soft key to quickly access parameters on the currently attentioned channel.

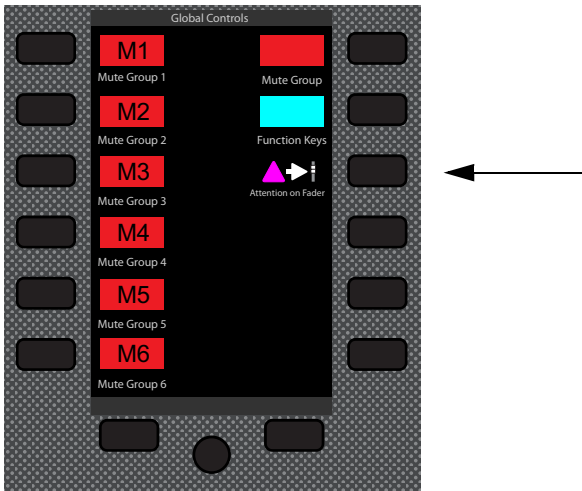

Attention Floating Fader

Pressing the soft key for Attention on Fader places the currently attentioned channel on the first fader of the CFM below the MLM, and locally selects it. The **Select** switch on that strip flashes purple. The Attention on Fader will override any Bank Safed channel on the strip (any Bank Safed channel will remain on that strip but is temporarily hidden by the Attention on Fader).

The CKM OLEDs display any previously displayed parameters (or Channel view if no parameters were previously displayed in Attention on Fader mode).

When the channel is unselected (by pressing its flashing **Select** switch, selecting another channel in that bank of 8 faders or the bank to its right (if present), pressing **Select Clear**, pressing the Attention on Fader soft key again, or closing Channel view on a CTM), the Attention on Fader strip returns to its previous channel assignment. Changing fader banks will unselect faders on the previous bank.

Flip mode and Sends on Faders mode remain available and do not cancel Attention Floating Fader mode.

Selecting/Attentioning Multiple Channels (Multi-Select)

Multi-Select lets you select or attention multiple channels in order to apply an action to them in one step, such as adjusting multiple channel's High-Pass Filters, turning Aux sends on or off for multiple channels, or assigning multiple channels to a bus. You can multi-select channels using **Select** or **Attention**.

When you multi-select using **Select**, you can adjust parameters for all selected channels using the associated CKM. When you multi-select using **Attention**, you can adjust parameters for all attentioned channels using the controls on the external screen.

Multi-Selecting Using Select

Multi-selecting using **Select** is “local”—only channels on the same fader bank can be multi-selected using **Select**.

To multi-select channels using the Select switch:

- 1 Bank to the desired channels.
- 2 Do either of the following:
 - Press and hold the **Multi-Select** switch at the top-left of the MLM, then press the **Select** switch on each channel you want to include in the selection.



Multi-Select switch

- Hold down the **Select** switch on the first channel, then press the **Select** switch on each channel you want to include in the selection.

 You can also use the Shift key on the keyboard to select multiple channels.

- 3 If you used Multi-Select, release the **Multi-Select** switch. The flashing **Multi-Select** switch flashes to indicate Multi-Select mode is enabled.
- 4 Press a Channel Control Function switch to target those parameters to the associated CKM encoders.
- 5 Adjust a parameter on the CKM. The operation is applied to all selected channels.
- 6 To exit Multi-Select mode, do any of the following:
 - Select an unselected channel on the same fader bank.
 - Bank to a different set of channels.

Multi-Selecting Using Attention

Multi-selecting using **Attention** is “global”—any channels in the system regardless of its current banking status can be multi-selected using **Attention**.

 For information on working with external screen controls, including attentioning channels, see [Attentioning Channels from the External Screen](#).

To multi-select channels using Attention switches:

- Press and hold the **Attention** switch on the first channel you want to attention, then press **Attention** on each channel you want to include.

To multi-select channels using Multi-Select:

- 1 Press and hold the **Multi-Select** switch at the top-left of the MLM.
- 2 Press the **Attention** switches for any channels you want to include in the selection.
- 3 If necessary, bank to other channels as desired, and press their **Attention** switches to add to the multi-selection.
- 4 When finished multi-selecting channels, release the **Multi-Select** switch. The flashing **Multi-Select**, **OK** and **Cancel** switches, and the banner display at the lower left of the external screen flash to indicate Multi-Select mode is enabled.



Flashing OK and Cancel switches

5 To adjust parameters, do any of the following:

- If no channel is locally selected, adjust a parameter on the CKM in Channel Strip mode.
- Press the **Select** switch to enable Channel Control mode on the associated CKM, then press a Channel Control function switch to access the desired parameter(s).

Any adjustments are applied to all multi-selected channels.

6 To exit Multi-Select mode, do any of the following:

- Attention an un-attentioned channel.
- Press **Cancel**.
- Press **Multi-Select**.

Adjusting Channel Parameters

This chapter describes the following:

- [Assigning Channels to Outputs](#)
- [Adjusting Input Parameters on the Control Surface](#)
- [Adjusting EQ on the Control Surface](#)
- [Adjusting Dynamics on the Control Surface](#)
- [Adjusting Plug-Ins on the Control Surface](#)
- [Using the CHANNEL Function](#)
- [Flipping Parameters to Faders \(Flip to Faders Mode\)](#)
- [Encoder Assign Mode](#)



You can also adjust many channel parameters using the external VENUE software screen. See [Adjusting Parameters on the External Screen](#) for more information.

Configuring and Patching Channels

Before adjusting channels, make sure you have configured your Mains and Mix Buses, patched hardware I/O to input and output channels, and configured channels as desired (such as naming channels and making stereo channels). See the following for more information:

- ◆ Configure Mains and Mix Buses (Aux and Groups) on the System > Options page. See [Configuring Mains and Mix Buses](#).
- ◆ Patch hardware I/O to input and output channels using the VENUE Patchbay. See [Patching Input Sources to Input Channels](#) for more information.
- ◆ Name channels, combine two mono channels into one stereo channel (make stereo), reorder input channels, and insert blank channel strips using the Inputs and Outputs pages of the external screen. See [Configuring Channels on the External Screen](#) for more information.

Assigning Channels to Outputs

You can assign channels to the Mains, Auxes, Groups and VCAs using Multi-Assign. You can assign channels to the Mains and Groups using the CKMs in Channel Control mode.

 For information on assigning input sources to Matrix Mixers, see [Assigning Input Sources to Matrix Mixers](#).

Assigning Channels Using Multi-Assign

Multi-Assign lets you assign multiple channels to a bus or VCA at once. Assigning channels using the MTS is the quickest and easiest way to assign channels.

 You can also multi-assign to [Mute Groups](#).

To assign channels using Multi-Assign:

- 1 On the MTS, touch the Channel Type button for the output you want to target for the multi-assign (Auxes, Groups, VCAs, or Mains).
- 2 Touch Attention.



An enabled Attention Channel Tile Function button

- 3 Touch the channel tile for the output channel you want to target for the multi-assign so the channel tile is bordered in blue.
- 4 Touch Multi-Assign on the CTM, or press the **Multi-Assign** switch on the control surface MLM so they are lit.

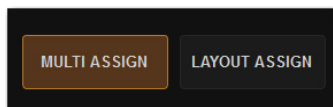

Enabled Multi-Assign button on the MTS (left) and on the MLM (right)

- 5 On the MTS, touch Inputs, and then touch the channel tiles for the channels you want to assign so the channel tiles are bordered in orange.
 - or –
 - Bank the desired input channels to the faders and press their **Attention** switches.
- 6 To confirm the assignment and exit Multi-Assign mode, press the **OK** switch
- 7 To cancel the assignment, press the **Cancel** switch, or press the Esc key on your keyboard.

Assigning Channels to the Mains

You can assign input channels to the Mains using the CKM encoders in Channel Control mode and on the external screen:

To assign input channels, Aux outputs, and Group outputs to Mains in Channel Control mode:

- 1 Select one or more channels you want to assign to the Mains buses.
- 2 On the associated CKM, press the **INPUT** Channel Control Function switch
 - or –
 - Touch the Input touch zone for the desired channel on the associated CTM in Meters or Channel view.

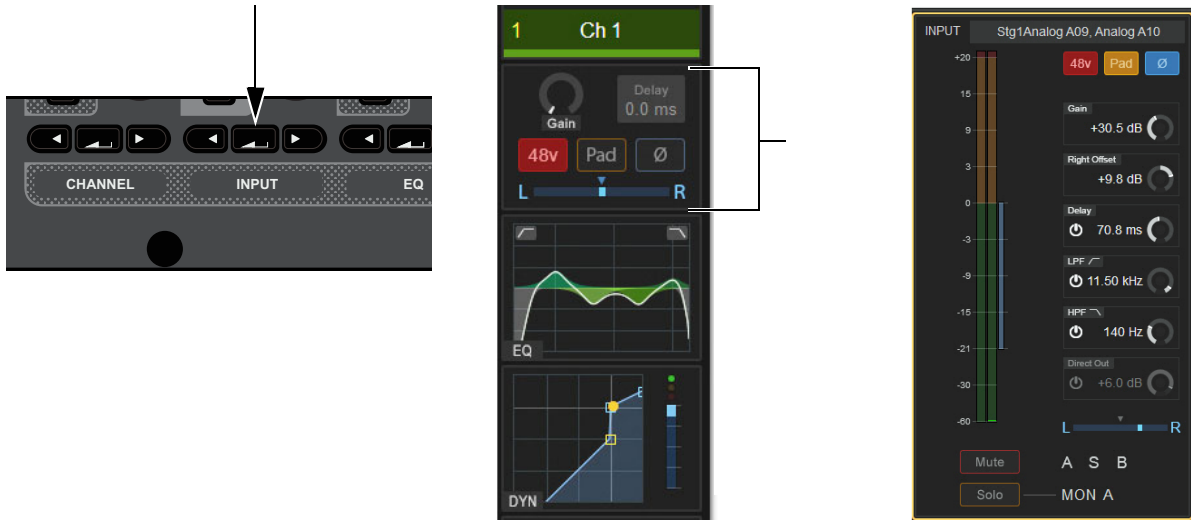

Input Channel Control Function switch (left), Input touch zone in Meters view (center), Input touch zone in Channel view (right)

3 Do any of the following:

- To assign the channel(s) to the Mains Left and Right, press the encoder under the display showing L-R Assign.
 - To assign the channel(s) to the Mains Center/Mono, press the encoder under the display showing C-M Assign.
- The encoder **In** switch lights, the virtual encoder surround on the display fills, and the encoder turns red.



Encoder and display showing a channel assigned to Mains L-R (left) and C/Mono (right)

Assigning Input Channels to Groups

You can assign input channels to Groups using the CKM. The number of Group buses available, and which Mix Channel Control function switch lets you access them, depends on the overall Mix Bus configuration. To change the Mix Bus configuration, see [Configuring Mix Buses](#).

To assign an input channel to a Group in Channel Control mode:

- 1 Select one or more channels.
- 2 On the associated CKM, press **Mix** Channel Control Function switch 2 or 3, depending on the overall Mix Bus configuration. Group assigns are spilled to the encoders.

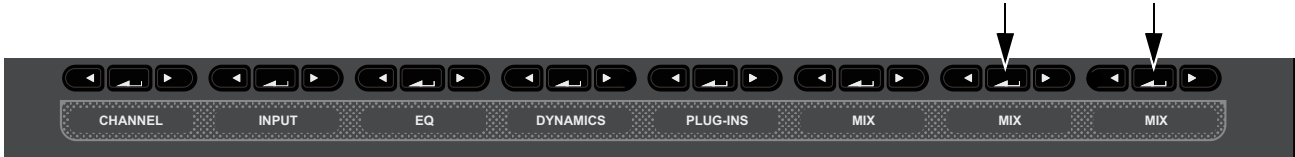

Mix Channel Control Function Switches

- 3 Press the orange encoder under the display showing the Group to which you want to assign the channel(s). The following elements indicate that the channel is assigned:
 - The encoder **In** switch lights.
 - In the encoder display, **On** is shown and the encoder fills in.
 - On-screen, the corresponding bus indicators are lit in the Bus Assign sections of the MTS and CTM Channel views, and on the Inputs page of the external screen.



Encoder and display showing a channel assigned to Group 1 (left) and on-screen for the selected/attended channel (right)

Assign VCAs and Mute Groups from Channel Control Encoders

You can assign input channels to Mute Groups and VCAs using the CKM encoders in Channel Control mode.

To assign input channels to Mute Groups and VCAs in Channel Control mode:

- 1 Select one or more channels you want to assign to a VCA or Mute Group.
- 2 On the associated CKM, press the **INPUT** Channel Control Function switch.
Or, touch the Input touch zone for the desired channel on the associated CTM in Meters or Channel view.
- 3 To assign the channel(s) to a Mute Group, rotate the encoder under the display showing **MUTE Asn**.
- 4 To assign the channel(s) to a VCA, rotate the encoder under the display showing **VCA Asn**.
- 5 When the desired VCA or Mute Group is displayed in the OLED, press the encoder or press the **IN** switch next to the encoder.



CKM OLED showing a channel assigned to the Mute Group "All Band"

The **SEL** switch indicates Mute status of the currently selected VCA or MUTE Group. Pressing **SEL** toggles Mute of the selected VCA or MUTE group.

Adjusting Input Parameters on the Control Surface

This section describes how to adjust top-of-channel parameters, which are the parameters you access when you press the **INPUT** Channel Control function switch or touch the Input touch zone on a CTM. You can also adjust some input parameters on the CKM encoders in Channel Strip mode.

 You can also adjust input parameters on the external screen. See [Adjusting Parameters on the External Screen](#).

The parameters provided by the Input function depend on the type of channel that is currently selected, as follows:

Selected Channel Type	Available INPUT Parameters
Input Channels	Input Gain, 48 V, Pad, LPF, HPF, Pan, Balance*, Width*, Delay, Direct Out, Polarity, Right Offset*, Bank Safe, Solo Safe, Automation Safe, Input Source Toggle, L-R and C/Mono Assign
Auxes and Groups	Polarity, Delay, Direct Out, Pan, Balance*, Width*, Bank Safe, Automation Safe, L-R and C/Mono Assign
Matrixes	Polarity, Delay, Direct Out, Pan, Width*, Bank Safe, Automation Safe
Mains	Polarity, Delay, Direct Out, Pan, Bank Safe, Automation Safe

* These parameters are available only for stereo channels.

Adjusting Input Gain

Input Channels Only

S6L system analog mic/line XLR inputs have a gain range from +10 dB to +60 dB. All system digital inputs (including AES digital inputs and inputs from Pro Tools) have a gain range from -20 dB to +18 dB. You can adjust gain in Channel Control and Channel Strip modes. S6L systems also provide an automated Gain Guess feature for quick and easy gain setting.

 If you repatch a hardware input to a different channel, Input gain, pad and phantom power move with the hardware input, replacing those settings on the destination channel. This occurs when repatching manually (in the Patchbay) or via a snapshot.

To adjust channel input gain in Channel Control mode:

- 1 Bank to the desired input channels, then do one of the following:
 - Select a channel, and then press the **INPUT** Channel Control Function switch on the associated CKM.

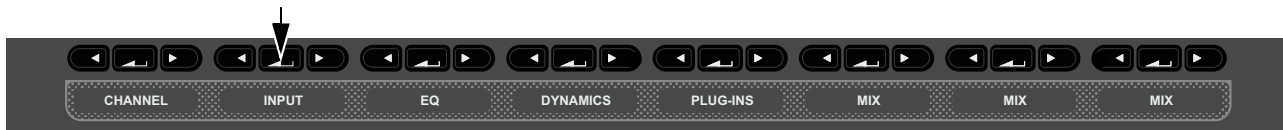

INPUT Channel Control Function switch

- Or, touch the Input touch zone for the desired channel on the associated CTM in Meters or Channel view.

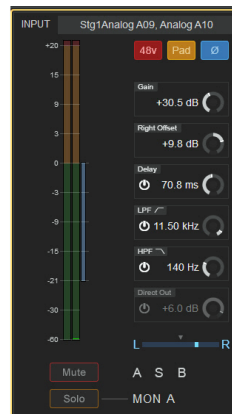

Input touch zone on the CTM in Meters view (left) and in Channel view (right)

The **INPUT** switch lights, the Input touch zone is bordered in orange, and Input parameters are spilled to the CKM.

- 2 Locate the encoder display showing **Gain**, and rotate the corresponding encoder.

The gain value changes in the encoder displays, in the Inputs zone of the MTS and CTM Universe view, and in the Input section of the Inputs page for the channel on the external screen (if the selected channel is also attentioned).



Encoder display showing parameter and parameter value

To adjust channel input gain in Channel Strip mode:

- 1 Bank to the desired input channels.
- 2 Do either of the following to enable Channel Strip mode:
 - Press a lit **Select** switch to de-select it and enable Channel Strip mode on the associated CKM.
 - Press **Select Clear** to de-select all channels on the control surface and enable Channel Strip mode on all CKMs.



Select Clear on the MLM

- 3 If necessary, navigate to the first Channel Strip mode parameter bank by pressing the lit Left Parameter Bank switch until **Gain** appears in the top row encoder displays.

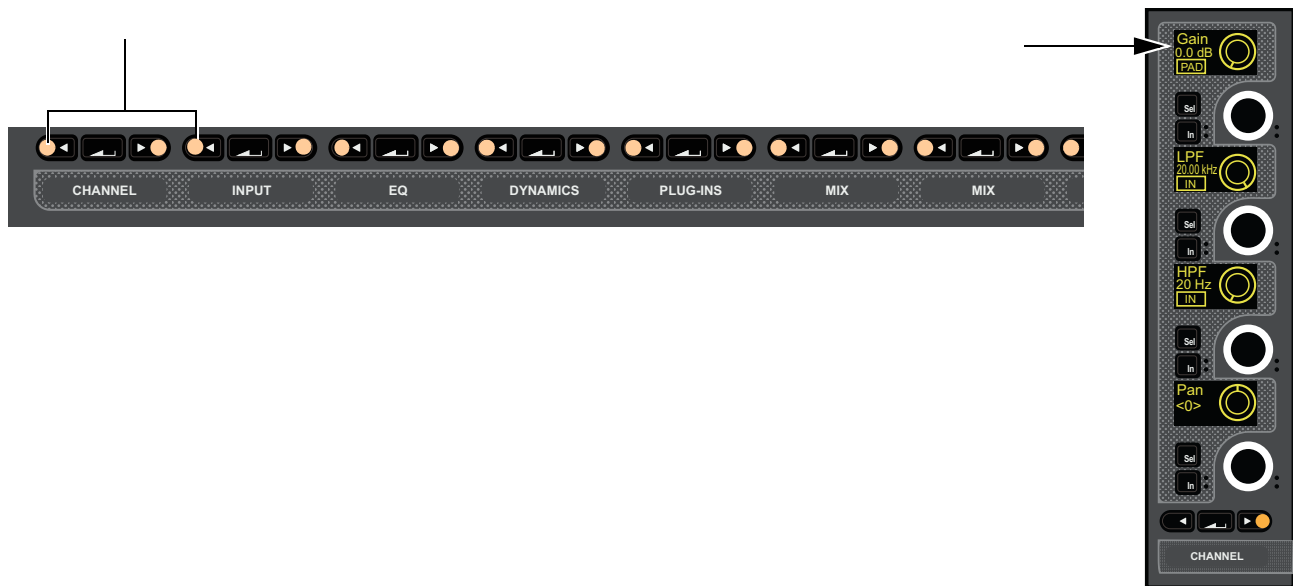

Lit Left Parameter Bank Switches (left) and the first page of Channel Strip parameters for input channels (right)

- 4 In the column for the channel you want to adjust, rotate the encoder under the display showing **Gain**. The gain value in the display changes as you adjust the parameter.

Using Gain Guess

The automated Gain Guess function can be used to set a nominal level for a channel based on its incoming signal. When you enable Gain Guess, the system samples the incoming signal and automatically sets the channel Input Gain and pad for a 0 dB reference. Gain Guess follows the current Meter mode (Peak or RMS). You can access Gain Guess on the external screen.

To engage Gain Guess:

- 1 On the external screen, go to the Inputs page.
- 2 Attention a channel.
- 3 Touch and hold the **Guess** button. The button flashes to indicate level sampling.



Gain Guess engaged

- 4 Release the button. Input Gain will be set so the incoming signal reaches 0 dB peak (if Peak mode is selected) or 0 dB RMS (if RMS mode is selected).

Setting Right Offset on Stereo Channels

On stereo input channels the Gain control affects both the left and right channels. The Right Offset feature lets you offset the gain of the right channel relative to the left channel by -20 dB to $+20$ dB, within the overall gain limits. You can adjust Right Offset in Channel Control and Channel Strip modes.

To adjust Right Offset in Channel Control mode:

- 1 Bank to the desired input channels, then do either of the following:
 - Select a channel, and then press the **INPUT** Channel Control Function switch on the associated CKM.
 - On the associated CTM, touch the Input touch zone for the desired channel.
- 2 Rotate the encoder under the display showing **R. Offset**.

To adjust Right Offset in Channel Strip mode:

- 1 Bank the desired input channels.
- 2 Enable Channel Strip mode on the CKMs by doing either of the following:
 - Press a lit **Select** switch to enable Channel Strip mode on the associated CKM.
 - Press **Select Clear** to de-select all channels on the control surface and enable Channel Strip mode on all CKMs.
- 3 If necessary, navigate to the first Channel Strip mode parameter bank by pressing any lit Left Parameter Bank switches until **Gain** appears in the top row encoder displays.
- 4 In the column for the channel you want to adjust, press the encoder **Sel** switch under the display showing **Gain**. **R. Offset** is now shown in the display, and the encoder targets the Right Offset parameter.
- 5 Rotate the encoder under the display showing **R. Offset** to adjust the Right Offset. The gain value in the display changes as you adjust the parameter.

20 dB Pad

Analog Input Channels Only

You can apply a 20 dB pad to any analog input assigned to an input channel in Channel Control and Channel Strip modes.

To toggle a channel pad in/out in Channel Control mode:

- 1 Bank to the desired input channels.
- 2 Select a channel, and then press the **INPUT** Channel Control Function switch on the associated CKM.
 - or –
 - On the associated CTM, touch the Input touch zone for the desired channel.
- 3 Press the encoder under the display showing Pad. When the pad is engaged, the encoder surround in the display fills in, PAD lights in the display, and the encoder **In** LED lights green.

To toggle a channel pad in/out in Channel Strip mode:

- 1 Bank the desired input channels.
- 2 Do either of the following to enable Channel Strip mode:
 - Press a lit **Select** switch to enable Channel Strip mode on the associated CKM.
 - Press **Select Clear** to de-select all channels on the control surface and enable Channel Strip mode on all CKMs.
- 3 If necessary, navigate to the first Channel Strip mode parameter bank by pressing the lit Left Parameter Bank switch until Gain appears in the top row encoder displays.
- 4 In the column for the channel you want to adjust, press the encoder **In** switch under the display showing Gain. The **In** LED lights green to indicate the Pad is in.

48 V (Phantom Power)

Input Channels Only

You can apply 48 V phantom power to any analog input assigned to an input channel in Channel Control mode.

To apply 48 V:

- 1 Bank to the desired input or output channels.
- 2 Select a channel, and then press the **INPUT** Channel Control Function switch on the associated CKM.
 - or –
 - On the associated CTM, touch the Input touch zone for the desired channel.
- 3 Press the encoder under the display showing 48 V. The encoder surround in the display fills in, 48V lights in the display, and the encoder **In** LED lights green to indicate that 48 V is active on that channel.

Delay

You can apply up to 250 ms of delay to an input channel, or up to 500 ms of delay to an output channel (except VCAs) in Channel Control mode.

To delay to a channel:

- 1 Bank to the desired input channels.
- 2 Select a channel
- 3 Press the **INPUT** Channel Control Function switch on the associated CKM.
- 4 To engage channel delay, press the encoder under the display showing Delay so IN is lit in the display.
- 5 Rotate the encoder to adjust the delay time.



Delay can be shown in milliseconds, feet, meters, or samples. See [Tap Tempo](#).

Pan/Balance/Width

Pan adjusts channel pan (for mono channels) and stereo balance (for stereo channels). On stereo channels, width controls are also provided. You can adjust pan controls for input channels, Aux outputs and Group outputs in Channel Control and Channel Strip modes.

To adjust pan in Channel Control mode:

- 1 Bank to the desired input or output channels.
- 2 Select a channel, and then press the **INPUT** Channel Control Function switch on the associated CKM.
 - or –
 - On the associated CTM, touch the Input touch zone for the desired channel.
- 3 Rotate the encoder under the display showing **Pan** (mono channel) to adjust pan, or **Balance** (stereo channels) to adjust balance.

To adjust pan in Channel Strip mode:

- 1 Bank the desired input channels.
- 2 Do either of the following to enable Channel Strip mode:
 - Press a lit **Select** switch to de-select it and enable Channel Strip mode on the associated CKM.
 - Press **Select Clear** to de-select all channels on the control surface and enable Channel Strip mode on all CKMs.
- 3 If necessary, navigate to the first Channel Strip mode parameter bank by pressing the lit Left Parameter Bank switch until **Pan** (or **Balance** for stereo channels) appears in the bottom row encoder displays.
- 4 In the column for the channel you want to adjust, rotate the encoder under the display showing **Balance**.

Stereo Width

Stereo Channels Only

Width adjusts the stereo image of stereo channels by controlling ganged pan positions of the left and right channels, in opposite directions. Width can be adjusted from full L–R, to mono, to full inverted R–L. You can adjust width controls for stereo channels only in Channel Control and Channel Strip modes.

To adjust width in Channel Control mode:

- 1 Bank to the desired input or output channels.
- 2 Select a channel, and then press the **INPUT** Channel Control Function switch on the associated CKM.
 - or –
 - On the associated CTM, touch the Input touch zone for the desired channel.
- 3 Rotate the encoder under the display showing **Width**.

To adjust width in Channel Strip mode:

- 1 Bank the desired input channels.
- 2 Do either of the following to enable Channel Strip mode:
 - Press a lit **Select** switch to de-select it and enable Channel Strip mode on the associated CKM.
 - Press **Select Clear** to de-select all channels on the control surface and enable Channel Strip mode on all CKMs.
- 3 If necessary, navigate to the first Channel Strip mode parameter bank by pressing the lit Left Parameter Bank switch until **Balance** appears in the bottom row encoder displays.
- 4 In the column for the channel you want to adjust, under the display showing **Balance** press the encoder **Sel** switch. **Width** is shown in the display, and stereo width is now targeted to the encoder.
- 5 Rotate the encoder to adjust stereo width.

High- and Low-Pass Filters (HPF and LPF)

Input Channels Only

The S6L system provides built-in 4th-order full-spectrum high- and low-pass filters on each input channel. You can adjust HPF and LPF on the CKMs in Channel Control and Channel Strip mode using the Input or EQ functions.

To adjust HPF and LPF in Channel Control mode:

- 1 Bank to the desired input channels.
- 2 Select a channel, and then press the **INPUT** or the **EQ** Channel Control Function switch on the associated CKM.
 - or –
 - On the associated CTM, touch the Input or EQ touch zone for the desired channel.
- 3 To engage the filters on the channel, press the encoders under the displays showing HPF (for the high-pass filter) and LPF (for the low-pass filter), as desired. Each filter's corresponding encoder **In** switch lights to indicate that the filter is engaged, and **IN** lights in the corresponding display.
- 4 To adjust the frequency, rotate encoders as follows:
 - Rotate the HPF encoder to the right to raise the filter's corner frequency from its default starting frequency of 20 Hz.
 - Rotate the LPF encoder to the left to lower the filter's corner frequency from its default starting frequency of 20 kHzFiltering is shown on-screen in the EQ section of the MTS and CTM Universe view, and in the EQ section of the Inputs page for the channel on the external screen (if the selected channel is also attentioned).

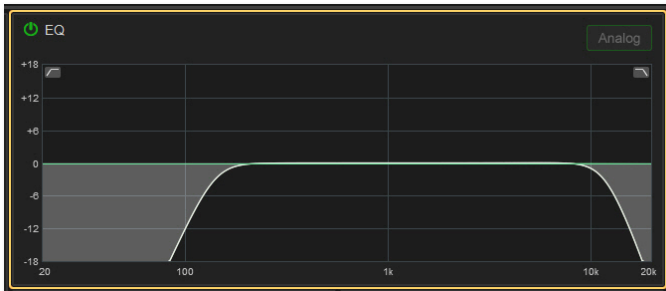

EQ section of the MTS Universe view showing high- and low-pass filtering on a channel

To adjust HPF and LPF in Channel Strip mode:

- 1 Bank the desired input channels.
- 2 Do either of the following to enable Channel Strip mode:
 - Press a lit **Select** switch to de-select it and enable Channel Strip mode on the associated CKM.
 - Press **Select Clear** to de-select all channels on the control surface and enable Channel Strip mode on all CKMs.
- 3 If necessary, navigate to the first Channel Strip mode parameter bank by pressing the lit Left Parameter Bank switch until HPF and LPF appear in the second and third row encoder displays.
- 4 Press the encoders under the displays showing HPF (for the high-pass filter) and LPF (for the low-pass filter), as desired, to engage the filters on the channel. Each filter's corresponding encoder **In** switch lights to indicate that the filter is engaged.
- 5 Rotate each filter's corresponding encoder to adjust the filter.

Polarity Invert (Phase Reverse)

You can invert the polarity of input channels, Aux outputs, Group outputs, and the Mains. With stereo channels, only the left channel is inverted. With Mains, regardless of the linked state of the Mains buses, polarity is inverted on both the Left and Right buses, Polarity is inverted on the C/Mono bus independently of the Mains Left and Right.

To invert the polarity in Channel Control mode:

- 1 Bank to the desired input or output channels.
- 2 Select a channel, and then press the **INPUT** Channel Control Function switch on the associated CKM.
 - or –
 - On the associated CTM, touch the Input touch zone for the desired channel.
- 3 Press the encoder below the display showing **Polarity**. The encoder surround in the display fills in and the encoder **In** LED lights green to indicate that the polarity is now inverted on that channel.

Direct Outs

You can turn on and adjust the level of Direct Outputs of input channels, Auxes, Groups, Matrixes, and Mains using the CKM in Channel Control mode. Channels are patched to hardware outputs or Pro Tools outputs using the Directs tab of the Patchbay on the external screen (See [Patching Direct Outputs](#)). You can also adjust Direct Outputs on the external screen Inputs and Output pages. Up to 12 dB of gain can be added to the Direct Output signal.

To adjust Direct Outs in Channel Control mode:

- 1 Bank the desired input or output channels.
- 2 Select a channel, and then press the **INPUT** Channel Control Function switch on the associated CKM.
 - or –
 - On the associated CTM, touch the Input touch zone for the desired channel.
- 3 To turn on the channel's Direct Out, press the encoder under the display showing Dir Out. The encoder **In** LED lights green.
- 4 Rotate the encoder to adjust the Direct Out level of the channel.

 *Direct Out level can also be assigned to faders by defining [Events](#) with the Continuous Control on Faders action.*

Pro Tools Input Source Toggle (Virtual Soundcheck Input) (Input Channels Only)

You can toggle the input source for the currently selected input channel between a Pro Tools Virtual Soundcheck input and the Stage input source for the channel, letting you toggle individual channels between Virtual Soundcheck and Stage mode. This parameter mirrors the function of the Source Channel Menu option, available on the channel strip.

 *You can also toggle input using the Channel Menu and the external screen. See the [S6L Live Recording Guide.pdf](#) for more information,*

To toggle the input source for an input channel in Channel Control mode:

- 1 Bank the desired channel to the faders.
- 2 Select a channel, and then press the **INPUT** Channel Control Function switch on the associated CKM so it lights.
 - or –
 - Touch the channel's Input touch zone on the associated Channel Touch Module (CTM).
- 3 Press the encoder under the display showing PT Input. The encoder **In** switch lights, and the encoder surround in the display fills in to indicate the Pro Tools Virtual Soundcheck input is now the input source for the selected channel.

Safe

You can toggle a selected input channel's Bank, Automation, and Solo Safe, and a selected output channel's Bank and Automation Safe from the CKM in Channel Control mode. These Safe controls are independent of the global Channel Safe Switches settings on the Options > Interactions page of the external screen.

To toggle a channel Safe:

- 1 Bank to the desired input or output channels to the faders.
- 2 Select a channel, and then press the **INPUT** Channel Control Function switch on the associated CKM so it lights.
 - or –
 - Touch the channel's Input touch zone on the associated Channel Touch Module (CTM).
- 3 Locate the encoder showing the Safe you want to toggle, then press it. The encoder **In** switch lights, the encoder surround in the display fills in to indicate the Safe is enabled, and ON is lit in the display.

For example, to enable Bank Safe, press the encoder under the display showing **Bank Sf** on the encoder display.

The encoder **In** switch lights green, and the channel is Bank Safed.



Bank Safe parameter on a CKM encoder

 For more information on Bank Safe, see [Bank Safing Channels](#).

 For more information on Solo Safe, see [Solo Safing Channels](#).

 For more information on Automation Safe, see [Automation Safing Channels](#).

Adjusting EQ on the Control Surface

Each input channel has a built-in 4-band EQ. Each output channel (except VCAs) has a built-in 7-band parametric EQ. You can choose between two EQ types on a per-channel basis: a full-spectrum digital EQ or an analog-modeled EQ. You can adjust channel EQ on the CKMs in Channel Control mode. You can also adjust channel EQ band gain in Channel Strip mode.

S6L systems also provide 32 built-in insertable graphic EQs (GEQ) for output channels. You can adjust Graphic EQs inserted on output channels using the CKMs in Channel Control mode.

 You can also adjust EQ using the external screen, as well as accomplish other tasks including toggling digital and analog EQ modes, copy and paste EQ settings between channels, and save and recall EQ presets. See [Working with EQ and Dynamics on the External Screen](#).

Adjusting Channel EQ on the Control Surface

To adjust built-in channel EQ in Channel Control mode:

- 1 Bank to the desired input or output channels.
- 2 Select a channel, and then press the **EQ** Channel Control Function switch on the associated CKM.

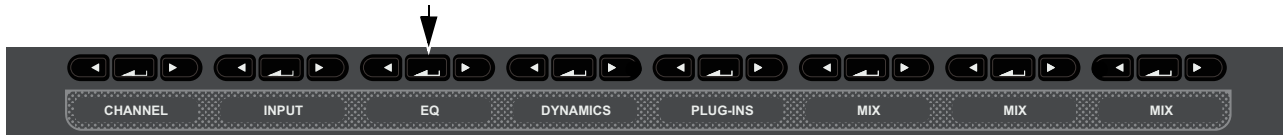

INPUT Channel Control Function switch (left) and the Input touch zone in the CTM Meters view (right)

– or –

- Touch the EQ touch zone for the desired channel on the associated CTM in Meters or Channel view.

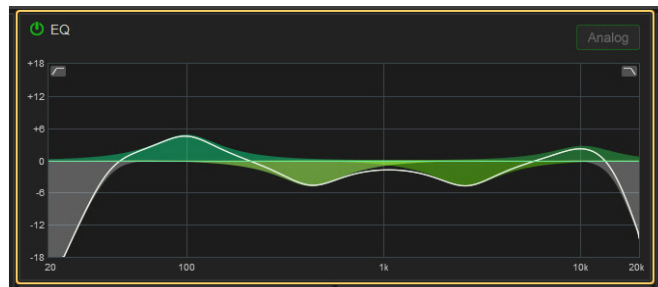

EQ touch zones on the CTM in Meters view (left) and in Channel view (right)

The **EQ** Channel Control Function switch lights, the EQ touch zone is bordered in orange, and EQ parameters are spilled to the associated CKM.

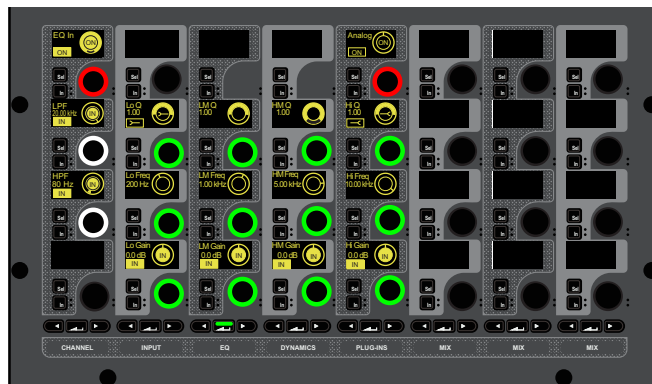

Built-in 4-band EQ parameters on the CKM

To toggle the processor in/out,

- Press the red encoder at the top left of the CKM, under the display showing EQ In.
The encoder **In** switch lights, and the encoder surround in the display fills in to indicate the EQ is engaged.

To toggle individual EQ bands in/out:

- Press the encoder **In** switch below the display showing EQ band gain (the encoders along the bottom row of the CKM). An EQ band is in when the switch lights.

To adjust EQ bands:

- 1 To adjust EQ band gain, under the displays showing Lo Gain, LM Gain, and so on rotate the desired encoder.
- 2 To adjust EQ band frequency, under the displays showing Lo Freq, LM Freq, and so on rotate the desired encoder.
- 3 To adjust EQ band Q, under the displays showing Lo Freq, LM Freq, and so on rotate the desired encoder.
- 4 To toggle between Bell and Shelf filters for the Hi and Lo bands:
 - Press the encoder **In** switch below the display showing Hi Q to toggle Shelf on the Hi EQ band.
 - Press the encoder **In** below the display showing Lo Q (or Lo 1 Q for outputs) to toggle Shelf on the Lo 1 EQ band. Shelf is active when the encoder **In** switch lights.

 For input channels, HPF and LPF parameters are also provided along with EQ parameters.

To adjust EQ band gain in Channel Strip mode:

- 1 Bank the desired input or output channels.
- 2 Do either of the following to enable Channel Strip mode:
 - Press a lit **Select** switch to de-select it and enable Channel Strip mode on the associated CKM.
 - Press **Select Clear** to de-select all channels on the control surface and enable Channel Strip mode on all CKMs.
- 3 Navigate to the EQ Channel Strip mode parameter bank by pressing a lit Parameter Bank switch, as available, until the encoders appear green.

When a CKM is in Channel Strip mode and displaying EQ parameters, the encoder **SEL** switches assign EQ Frequency to the corresponding encoder. Press **SEL** again to return the encoder to band Gain.

EQ band gain parameters for input channels appear on the second page of Channel Strip mode parameters, and pages two and three for output channels, as follows:

Channel Strip mode EQ parameters available per channel type

Input Channels		Output Channels		
CKM Encoder	Page 2	CKM Encoder	Page 2	Page 3
1 (top)	EQ Hi Gain	1 (top)	EQ Lo Mid 2 Gain	n/a
2	EQ Hi Mid Gain	2	EQ Lo Mid 1 Gain	EQ Hi Gain
3	EQ Lo Mid Gain	3	EQ Lo 2 Gain	EQ Hi Mid 2 Gain
4 (bottom)	EQ Lo Gain	4 (bottom)	EQ Lo 1 Gain	EQ Hi Mid 1 Gain

Adjusting Graphic EQ on the Control Surface (Output Channels Only)

GEQ parameters can be adjusted on CKMs or from the faders.

Adjusting GEQ on the CKM

To access GEQ parameters on the CKM, you must first insert a GEQ on the channel on the Outputs page of the external screen. See [Adjusting Graphic EQ on the External Screen](#).

To adjust GEQ in Channel Control mode:

- 1 Bank to the desired channels.
- 2 Select a channel, and then press the **EQ** Channel Control Function switch on the associated CKM.
 - or –
 - Touch the GEQ touch zone for the desired channel on the associated CTM in Meters or Channel view.

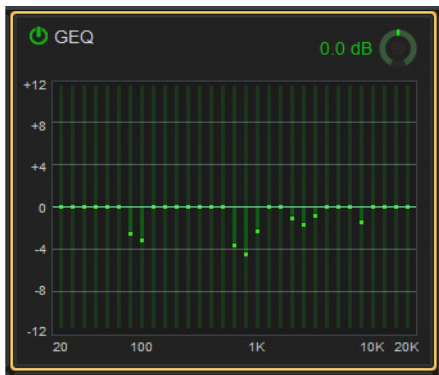

GEQ touch zones in Channel view

The **EQ** Channel Control Function switch lights, the EQ touch zone is bordered in orange, and channel EQ parameters are spilled to the associated CKM.

- 3 Press any lit Right Parameter Bank Navigation switch.

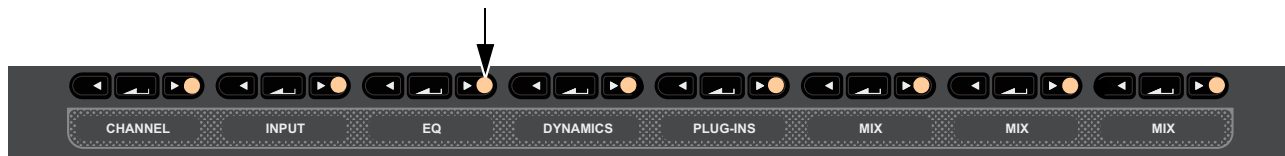

Lit Right Parameter Bank switches

GEQ parameters are spilled to all 4 rows of CKM encoders. Each individual band gain is assigned to an encoder.

- 4 To enable the GEQ, press the red encoder under the display showing In/Gain.
- 5 To adjust the overall output of the GEQ, rotate the red encoder.
- 6 To adjust individual band gain, rotate the corresponding encoders.

Adjusting GEQ on Faders

You can access an inserted Graphic EQ on the faders using the MLM Right Soft Keys, and using events to assign a Function switch that banks GEQ to the faders.

On S6L-32D systems, 31 bands of GEQ are available; on S6L-24D and S6L-24, the MLM Bank switches let you access other bands.

To access GEQ on Faders using the MLM Soft Keys:

- 1 Make sure the Right Soft Keys on the MLM are set to their Home view.
- 2 Press the Soft Key for GEQ on Faders.
- 3 To exit GEQ on Faders mode, press the GEQ on Faders Soft Key again.

To create an event for GEQ on Faders:

- 1 On the external screen, go to the **Media** page to show the **Events** screen.
- 2 To create an empty, untitled new event, do the following:
 - Click the **New** button in the Event Commands section.
 - Double-click the new event in the Events List and enter a name such as **GEQ on Faders**.
- 3 With the new event selected (highlighted in the Events List), click the **ADD** pop-up menu in the Triggers list and select the trigger type, such as **Function Switch 9**. The selected trigger type is added to the Trigger list for the currently selected event, with its default properties.
- 4 Click the **ADD** pop-up menu in the Action list and select **GEQ on Faders**.

 For more information on using the features of the Events screen, see [Events](#).

To access GEQ on Faders using an event:

- 1 Attention an Output Channel with a GEQ inserted on it.
- 2 Engage the trigger you selected to trigger GEQ on faders.
GEQ bands are spilled across all faders.
 - On S6L-32D systems, all bands spill across the faders.
 - On S6L-24D and S6L-24 systems, up to 24 bands spill across the faders. On the external screen, banked bands are lit white. To bank to the next or previous set of GEQ bands, press the lit **< Bank >** switches or use the Soft Keys to select the desired bands.
- 3 To access GEQ on a different channel, Attention that channel using the MTS Attention key (the channel must already have a GEQ inserted).

To cancel GEQ on Faders:

- Press the flashing **Cancel** switch.

Adjusting Dynamics on the Control Surface

All input and output channels provide a built-in Compressor Limiter (Comp/Lim), and input channels provide an Expander/Gate (Exp/Gate). Both built-in and most plug-in dynamics processors support sidechain processing.

For stereo channels, processor controls are linked and apply to both the left and right sides of the channel. For Mains L-R, processor controls are linked regardless of the Mains linked/unlinked state. Dynamics control for the C/Mono bus is always discrete.

You can adjust built-in Dynamics in Channel Control and Channel Strip modes. You can also toggle built-in Dynamics processors in/out using the channel strip **X** and **Y** switches.

💡 You can also adjust Dynamics, including the sidechain, using the external screen. See [Working with EQ and Dynamics on the External Screen](#).

To adjust built-in Dynamics in Channel Control mode:

- 1 Bank the desired input or output channels.
- 2 Select a channel, and then press the **DYNAMICS** Channel Control Function switch on the associated CKM.

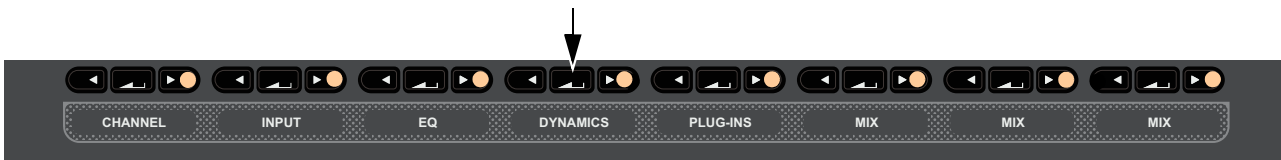

Dynamics Channel Control Function switch

– or –

- Touch the Dynamics touch zone for the desired channel on the associated CTM in Meters or Channel view.
- ◆ The **DYNAMICS** Channel Control Function switch lights, the Dynamics touch zone is bordered in orange, and Dynamics parameters are spilled to the associated CKM.

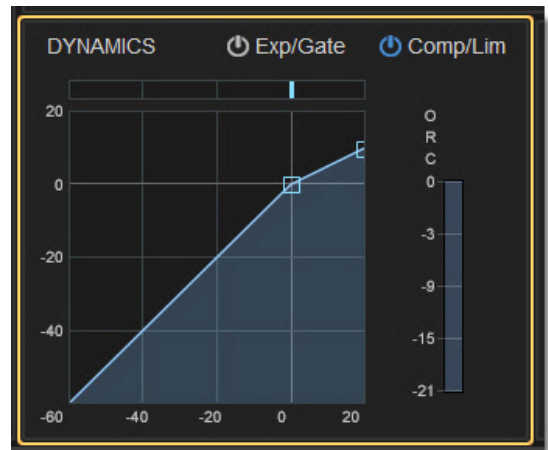
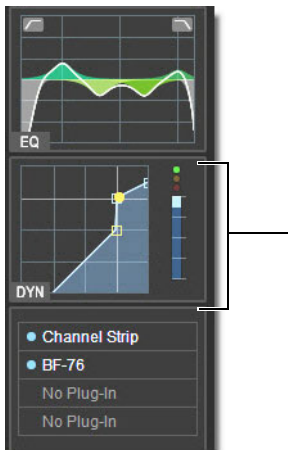

Dynamics touch zones on the CTM in Meters view (left) and in Channel view (right)

- ◆ For input channels, Exp/Gate parameters are assigned to the top two rows of encoders, and Comp/Lim parameters are assigned to the bottom two rows.
- ◆ For output channels, Comp/Lim parameters are assigned to the bottom two rows.

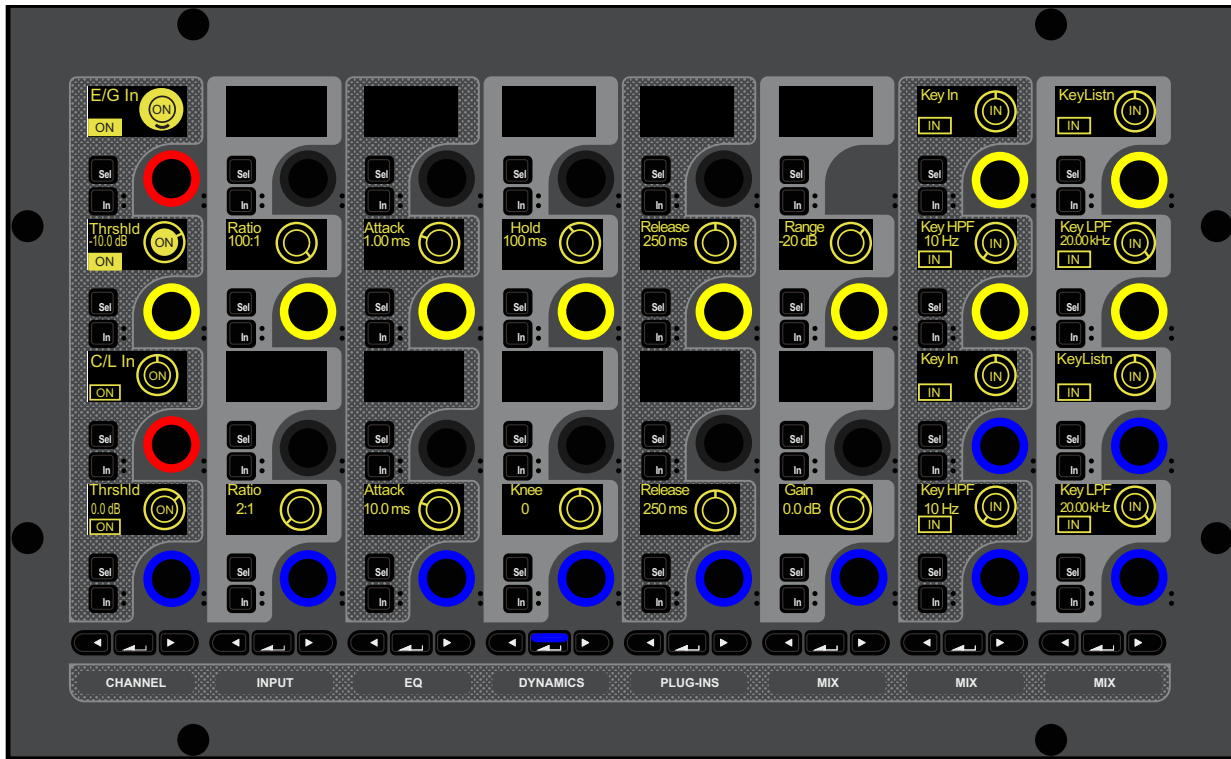

Input channel Dynamics parameters on a CKM in Channel Control mode

- To toggle Dynamics processors in/out, do any of the following:
 - To toggle Exp/Gate, press the red encoder under the display showing E/G In. When engaged (in), the encoder **In** switch lights, and the encoder surround in the display fills in.
 - To toggle Comp/Lim, press the red encoder under the display showing C/L In. When engaged (in), the encoder **In** switch lights, and the encoder surround in the display fills in.
- To adjust parameters, rotate the encoder under the display showing the parameter you want to adjust.
Gain reduction and gate activity is indicated on the channel strip gain reduction meters and in the Inputs zone on the associated CTM. See [Dynamics Meter](#) for more information.

To toggle Dynamics in/out using the X and Y switches:

- Press a channel strip **X** switch to toggle the Exp/Gate for that channel. The switch lights when the processor is engaged (in).
- Press a channel strip **Y** switch to toggle the Comp/Lim for that channel. The switch lights when the processor is engaged (in).

Sidechain

Dynamics processors typically use the detected amplitude of their input signal to trigger gain reduction. This split-off signal is known as the sidechain. The built-in Comp/Lim and Exp/Gate feature sidechain circuits with external key and EQ filter capabilities.

With sidechain EQ filters, you can make dynamics processing more or less sensitive to certain frequencies. For example, you might configure the sidechain so that certain lower frequencies on a drum track trigger dynamics processing. You can engage and adjust sidechain EQ filters on the CKM under the **DYNAMICS** function.

With external key sidechain processing, dynamics processing is triggered using an external signal (such as another input) instead of the input signal. This external source is known as the *key input*. Key input is selected in the Sidechain section of the Inputs or Outputs page of the external screen (see [Selecting the External Key Sidechain Input](#)).

Engaging the Sidechain

The sidechain must be engaged to enable both external key and EQ filter sidechain processing for the selected channel. The Key In control can be toggled in or out of circuit using the CKMs in Channel Control mode.

To toggle the sidechain:

- 1 Bank to the desired input or output channels.
- 2 Select a channel, and then press the **DYNAMICS** Channel Control Function switch on the associated CKM.
 - or –
 - Touch the Dynamics touch zone for the desired channel on the associated CTM in Meters or Channel view.
- 3 Press the encoder under the display showing Key In. When engaged (in), the encoder **In** switch lights, and the encoder surround in the display fills in.

Using Sidechain EQ Filters

Both the Compressor/Limiter and the Expander/Gate sidechains provide two bands of EQ to band-limit the range of frequencies that trigger dynamics processing.



For frequency-dependent gating or compression, make sure the Key Source is set to Self. See [Selecting the External Key Sidechain Input](#).

To activate a sidechain EQ filter in Channel Control mode:

- 1 Bank to the desired input or output channels.
- 2 Select a channel, and then press the **DYNAMICS** Channel Control Function switch on the associated CKM.
 - or –
 - Touch the Dynamics touch zone for the desired channel on the associated CTM in Meters or Channel view.
- 3 Press the encoder under the display showing Key In. When engaged (in), the encoder **In** switch lights, and the encoder surround in the display fills in.
- 4 Press the Channel Control encoder under the display showing Key HF and/or Key LF.

To adjust a side-chain EQ filter:

- Turn the Key HF and/or Key LF encoders to adjust the frequency (each filter ranges from 10 Hz to 20 kHz). In the encoder displays, the current frequency value is displayed on-screen.

Key Listen

The Key Listen button toggles the key onto the Monitor bus, replacing the signal there. This happens regardless of whether the key is the channel signal or the external key, or whether it has been sidechain filtered. Key Listen always overrides all other soloed channels. Any soloed channels are suppressed until Key Listen is cleared. If additional channels are soloed while Key Listen is on, they will be added but suppressed. The Key Listen solo is also exclusive to itself; pressing Key Listen on a different processor or channel turns off the previous Key Listen and the new Key Listen takes over.



Key Listen on a dynamics plug-in does not route the signal to the Monitor bus, but to the plug-in output. Use caution when using the Key Listen with a plug-in dynamics processor.

To engage Key Listen:

- Press the encoder under the displays showing KeyListn. When engaged (in), the encoder **In** switch lights, and the encoder surround in the display fills in.

To disengage Key Listen:

- Press the encoder again so the encoder **In** switch is unlit. The Solo bus reverts to its previous signal (soloed channels, or none). You can also press **Solo Clear** once to turn off any currently engaged Key Listen button. Press **Solo Clear** a second time to clear channel solos, if any.

Adjusting Plug-Ins on the Control Surface

You can adjust inserted plug-ins and bus-fed plug-ins using the CKMs.

Adjusting Inserted Plug-Ins

You can adjust the parameters of up to four inserted plug-ins using the CKMs in Channel Control mode. To access inserted plug-in parameters on the CKM, one or more plug-ins must be inserted on the channel (see [Inserting Plug-Ins on Channels](#)).

 You can also adjust plug-ins on the Plug-Ins page of the external screen. See [Adjusting Plug-Ins on the External Screen](#).

To adjust plug-ins in Channel Control mode:

- 1 Bank to the desired input or output channels.
- 2 Select a channel with one or more inserted, and then press the **Plug-Ins** Channel Control Function switch on the associated CKM.

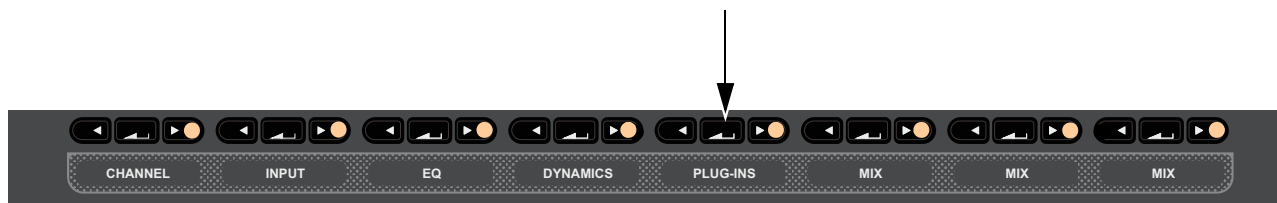

Plug-Ins Channel Control Function switch

– or –

- Touch the Plug-Ins touch zone for the desired channel on the associated CTM in Meters or Channel view.

The **PLUG-INS** Channel Control Function switch lights and the Plug-Ins touch zone is bordered in orange.

Red Plug-In Selectors are assigned to the leftmost encoders of each row of encoders on the associated CKM. Each Plug-In Selector corresponds to an Inserts slot 1–4 of the targeted channel, from top to bottom. If no plug-in is inserted into a slot, No Plug-In is displayed.

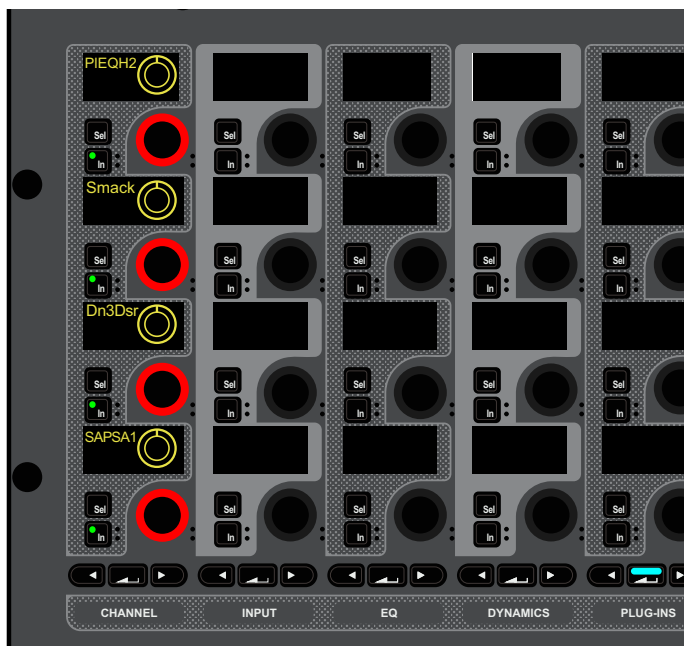
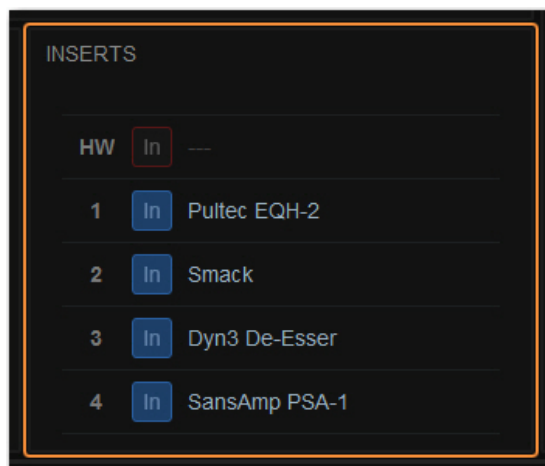

Inserts section on-screen with Inserted plug-ins (left) and corresponding Plug-In Selectors on a CKM in Channel Control mode (right)

- 3 To access a plug-ins parameters, press a red Plug-In Selector encoder under the display showing the name of the desired plug-in. The parameters for that plug-in are spilled to the encoders. On-screen, the targeted plug-in is bordered in red in the Inserts section of the channel, and on the external screen Plug-Ins page.

To toggle an individual plug-in on/off

- Press the encoder **In** switch for the corresponding Plug-In Selector. The following control surface and on-screen elements indicate when a plug-in is engaged (in):
 - The encoder **In** switch lights.
 - On the CTM in Meters view and in the Channel Tiles in Channel view, in the Inserts zone a blue dot appears next to the plug-in.
 - On the MTS and the CTM in Meters view, in the Inserts zone the On indicator for the plug-in lights blue.

To access another plug-in inserted on the same channel:

- Press the corresponding red Plug-In selector encoder. The next time you access plug-ins on this channel, the parameters for the last targeted plug-in are automatically spilled to the CKM encoders

Adjusting Bus-Fed Plug-Ins (Effect Returns)

You can adjust bus-fed plug-ins on the CKMs in Channel Control mode. You can adjust the bus-fed plug-in's parameters, plus any plug-ins inserted on the return channel. To access bus-fed plug-in parameters on the CKM, one or more plug-ins must be routed to a channel (see [Routing Plug-Ins as Bus Processors \(Effect Send/Return\)](#)).

To adjust a bus-fed plug-in:

- 1 Bank the channel to which the output of the bus-fed plug-in is routed to the faders
- 2 Select that channel, and then press the **Plug-In** Channel Control Function switch on the associated CKM.
 - or –
 - Touch the Plug-Ins touch zone for the desired channel on the associated CTM in Meters or Channel view.

The **PLUG-INS** Channel Control Function switch lights and the Plug-Ins touch zone is bordered in orange.

A red Plug-In Selector is assigned to the second encoder of the top row of encoders on the associated CKM, and plug-in parameters are spilled to the rest of the encoders.

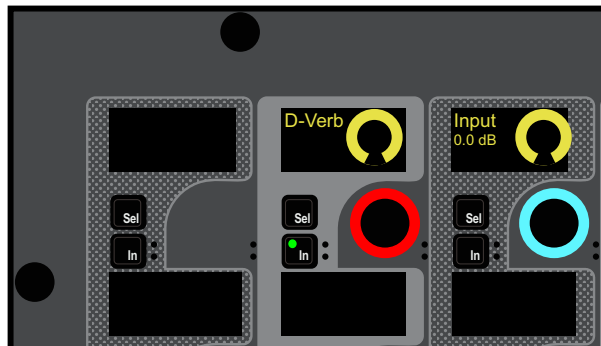

CKM with a bus-fed plug-in targeted to encoders

- 3 Adjust parameters as desired.

To toggle the bus-fed plug-in on/off:

- Press the encoder **In** switch for the corresponding Plug-In Selector.

To access plug-ins inserted on the return channel:

- Press the corresponding red Plug-In selector encoder in the leftmost column. The parameters for that plug-in are spilled to the encoders.

Using the CHANNEL Function

The **CHANNEL** Channel Control Function switch assigns a variety of channel parameters such as input, EQ, and Dynamics parameters to the CKM in Channel Control mode, providing a default set of utility parameters for the selected channel. You can customize this group of controls by assigning parameters to these encoders, up to a total of 32.

CHANNEL parameter encoder assignments are global, and apply to all channels. If an assigned parameter is not applicable for the selected channel type, that encoder is blank. Plug-In parameters are not available for custom parameter assignments. Custom assignments are saved with each Show file.

Accessing CHANNEL Parameters

To access the default **CHANNEL** parameters:

- 1 Bank to the desired input or output channels.
- 2 Select a channel, and then press the **CHANNEL** Channel Control Function switch on the associated CKM. The default parameters are spilled to the CKM's encoders.

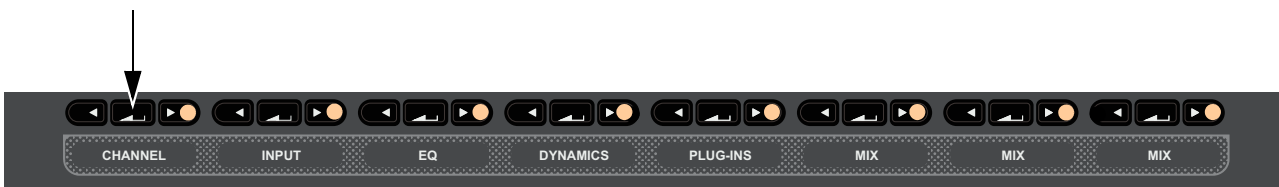

CHANNEL Channel Control Function switch

Assigning Custom CHANNEL Parameters

You can customize the parameters that are spilled to the 32 CKM encoders when you press the **CHANNEL** Channel Control Function switch. A custom assignment replaces any existing assignments on the selected encoder. To assign parameters, enable User Assignment mode on one CKM, then select the parameters you want to assign to **CHANNEL** using another CKM.

To enable **User Assignment mode**:

- 1 Select a channel on any fader bank.
- 2 Press and hold the **CHANNEL** Channel Control Function switch on the associated CKM.
The **CHANNEL** switch flashes to indicate that the CKM is in User Assignment mode.
The top-left encoder flashes red to indicate it is now the target for the custom assignment.
- 3 Press an encoder on the CKM that is in User Assignment mode to target that encoder for the custom assignment. That encoder now flashes.
- 4 On a CKM other than the one in User Assignment mode, do the following:
 - Access the Channel Control function containing the parameter(s) you want to assign to **CHANNEL**.
 - Touch the encoder for the parameter you want to assign.
That parameter is assigned to the targeted **CHANNEL** encoder.
The next encoder on the CKM in User Assignment mode flashes to indicate it is now the target for a custom assignments.
- 5 Repeat step 4 to assign other parameters to each targeted encoder.
- 6 When finished, press the flashing **OK** switch to confirm assignments and exit User Assignment mode.
– or –
 - Press the flashing **Cancel** switch to cancel, leaving all assignments unchanged and exit User Assignment mode.

Clearing CHANNEL Assignments

You can clear individual Channel Control assignments, or all assignments, on the Inputs and Outputs pages of the external screen.

To clear User assignments:

- 1 On the external screen, go to the Input or Outputs page.
- 2 Tap-and-hold (right-click) a parameter.
- 3 To clear a single parameter, choose Clear <parameter name> from the Channel Control sub-menu.
- 4 To clear all parameters, do the following:
 - Choose Clear All Assignments.
 - Select Clear to confirm, or select Cancel to cancel and leave the User assignment unchanged.

Flipping Parameters to Faders (Flip to Faders Mode)

Input Channels Only

You can flip a row of input channel parameters provided in Channel Strip mode to the faders, temporarily replacing channel level control with control of the currently targeted parameter on the faders. You can enable Flip to Faders for input channels from any CKM mode.

To flip parameters to faders:

- 1 Bank to the desired input channels to the faders
- 2 Press **Flip** so it lights (flashes).
The CKMs for all input channels enter Channel Strip mode.
The flashing row of encoders indicates the parameter that is currently flipped to faders.

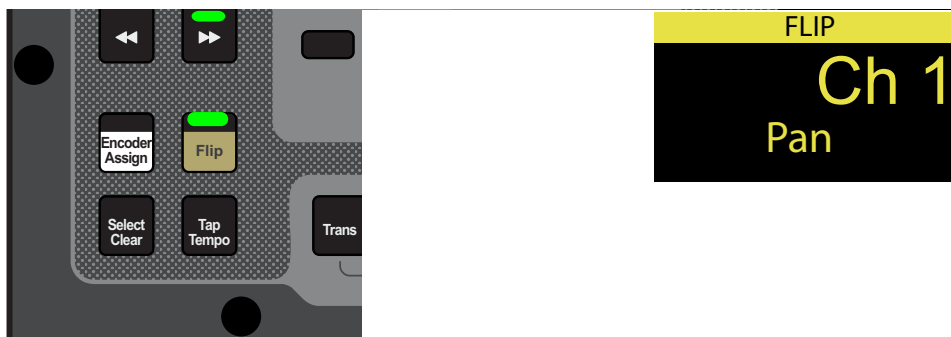

Flip switch enabled (left) and a channel display indicating that pan is flipped to faders (right)

- 3 Adjust the faders to change the parameter.
- 4 Touch an encoder in another row to flip that parameter to the faders.
 - or –
 - Press a lit Parameter Bank switch to navigate to another page of parameters, and then touch an encoder to flip its parameter to the faders.
- 5 To exit Flip to Faders, press **Flip** again so it is unlit, or press **Cancel**.
When Flip to Faders is enabled again, the previously flipped row of encoders is flipped to the faders.

Encoder Assign Mode

Encoder Assign mode lets you specify the parameters to display in each row of CKM knobs, letting you create and recall a custom variation of (vertical) Channel Strip mode. For example, when mixing monitors you can use Encoder Assign mode to quickly access wedge, side-fill, and sub sends for multiple channels.

You can create and save one custom Encoder Assignment per Show file.

To enter and use Encoder Assign mode from the control surface:

- 1 Press and hold **Encoder Assign** on the MLM for two or more seconds.

The **Encoder Assign** switch flashes white. On the far left CKM (or on the only CKM on S6L-16C) the top row of encoders flash red, indicating they are the target for encoder assignment.

- If no custom Encoder Assignment exists the displays on that CKM will be unlit; if a previous Encoder Assignment exists, its assignments are displayed.
- If any channel is on the left-most CFM of an S6L-32D or S6L-24D currently selected, it is automatically unselected; on S6L-24C, any/all selected channels are unselected.

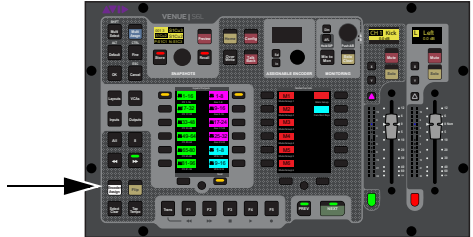

- 2 On the other CKM(s), or on-screen, touch the knob for any input, EQ, dynamics, or bus continuous control. (Plug-in parameters cannot be assigned.)

The selected parameter occupies the top row of the far left CKM, and the next row of knobs below it flashes red.

- 3 Repeat to assign other parameters to the remaining rows.

You cannot double-assign the same parameter to multiple rows (attempting to do so will blank out the currently targeted row and advance to the next row).

- 4 When finished, press **Encoder Assign** again (or press **OK** on the MLM, or tap select Done in the Encoder Assignment alert on-screen). The **Encoder Assign** switch stops flashing.

- 5 To recall your custom Encoder Assignment and display it across all CKMs that are in vertical (Channel Strip), press **Encoder Assign** (it lights white).

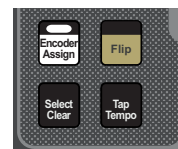

Encoder Assign mode enabled, with Input, Dyn, EQ, and Aux parameters assigned

To edit a custom Encoder Assignment:

- 1 Press and hold **Encoder Assign** for two or more seconds until it flashes white.
- 2 On the left-most CKM, tap to select the row of knobs you want to edit (knobs in that row flash red).
- 3 Touch the desired parameter on the other CKM(s) or on-screen.
- 4 Press **Encoder Assign** again.

Working with Mains and VCAs

Working with Mains

You can adjust Mains on the S6L control surface using the Flex Channels and the channel strips, and on the external screen. You can solo, mute, and attention Mains, as well as target Mains for a Multi-Assignment using the MTS.

By default, level and mute for all three Mains buses are linked. You can unlink any Mains channel to independently control level and mute. See [Linking/Unlinking Mains](#). Channel processing (such as EQ and dynamics) for Mains L-R are always linked. C/Mono is always processed independently of Mains L-R.

 See [Assigning Channels to the Mains](#) for instructions on assigning channels to VCAs.

Adjusting Mains Using the Flex Channels

By default, Mains L-R are assigned to Flex Channel 2. You also have the option of assigning C/Mono to a Flex Channel (see [Configuring Flex Channels](#)). When Mains L-R are linked, a single Flex Channel controls both Mains Left and Right. When Mains L-R are unlinked, a single Flex Channel controls the attentioned channel.

To adjust linked Mains L-R on a Flex Channel:

- To adjust Mains L-R output level, adjust the Flex Channel 2 fader.
- To mute Mains L-R, press the Flex Channel 2 **Mute** switch so it lights.
- To toggle the Mains L-R built-in Comp/Lim in/out, press the Flex Channel **Y** switch. Lit is in.

To adjust an unlinked Mains Left or Right on a Flex Channel:

- 1 Unlink the Mains Left and Right (see [Linking/Unlinking Mains](#)).
- 2 Press the **Attention** switch on the Mains L-R Flex Channel until the Flex Channel display shows “L” or “R.”

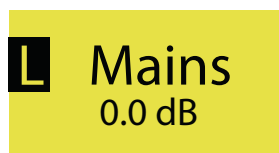

Flex Channel display showing Mains L targeted to the Flex Channel

- 3 To adjust the level of the attentioned Mains, adjust the Flex Channel fader.
- 4 To mute the attentioned Mains, press the Flex Channel’s **Mute** switch.

Adjusting Mains from the Channel Strips

You can adjust Mains using the channel strips by banking Mains to faders in Split Banking mode or Outputs Fader Bank mode.

To bank Mains in Split Banking Mode:

- 1 De-select a Fader Bank mode switch if one is enabled to enter Split Banking mode.
- 2 In the Left Soft Keys display, press the lit Next switch until you see Mains in the Soft Keys display

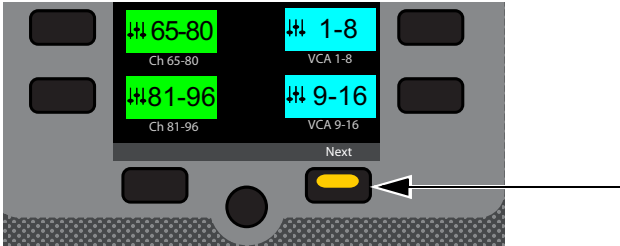

Lit Next switch

- 3 Press the Mains Soft Key so it lights.



Mains Soft Key

Mains Left, Right and C/Mono are banked to the three leftmost faders on the center fader bank (under the MLM). You can access Mains output processing controls as for other banked channels (as described in [Adjusting Channel Parameters](#)).



Mains banked to channel strips

To bank Mains Fader Bank mode:

- 1 Press the **Outputs** Fader Bank mode switch.
- 2 In the Left Soft Keys display, Press the Mains Soft Key so it lights.
Mains Left, Right, and C/Mono are banked to the three leftmost faders on the control surface.

Using Mains in a User Layout

When you assign Mains L-R + C/Mono to a User Layout, a single fader for each of the three Mains outputs is assigned to the Layout regardless of the Mains' linked/unlinked state. When Mains are linked, adjusting the fader in the User Layout controls levels for the linked Mains buses. You can target each individual Mains outputs on the control surface using the Attention switch, or on the external screen using the Mains Focus button.

To target an individual Mains output in a User Layout on the control surface:

- 1 Assign the Mains to a User Layout (see [Assigning Channels to a User Layout](#)).
- 2 Press the **Layouts** Fader Bank Mode switch. Mains L-R + C/Mono are assigned to a single fader.
- 3 To attention one of the Mains, press the channel strip **Attention** switch until the channel display shows the desired Mains output.

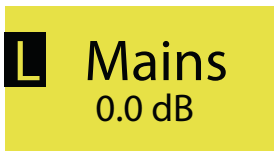

A channel display showing Mains L targeted to the fader

To target an individual Mains output in the User Layout on the external screen:

- 1 Select the Inputs or Outputs page, fader strip, select the Mains Focus button above the Mute button to cycle through each Mains channel.

To attention an individual Mains output on the external screen:

- 1 Assign the Mains to a User Layout and bank the User Layout
- 2 On the User Layout Mains fader strip, select the Mains Focus button to cycle through each Mains channel. The currently targeted Mains bus is indicated in the button (L, R, C/M).

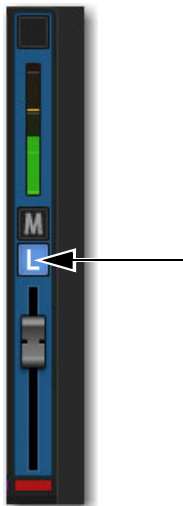

Mains Focus button

Linking/Unlinking Mains

By default, all three Main buses are linked in terms of level control and mute status. You can unlink any of the three Main buses for discrete control of level and mute.

 *Channel processing for the Mains Left-Right, such as built-in EQ, dynamics, and plug-ins, are always linked, regardless of its linked/unlinked status.*

To unlink the Mains:

- In the Outputs page, select the on-screen channel Link boxes for the Left, Right, and/or C/Mono fader strips so they are unlit.

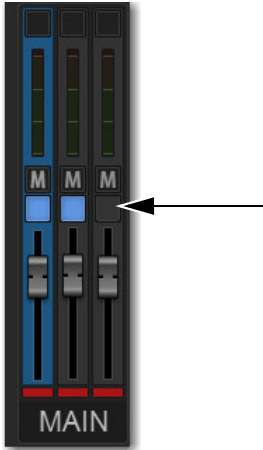

Fader strip link boxes

Working with VCAs

VCA controls emulate the operation of traditional Voltage Controlled Amplifiers (VCAs). Up to 32 VCAs are available. Any system channels can be assigned to VCAs.

 *VCAs control level of the assigned channels only. They do not act as a summing output bus.*

VCAs remotely control the fader gain of each channel assigned to the VCA fader, but do not change the position of the faders on those channels. The accumulated gain of a channel assigned to one or more VCAs is limited to +12 dB.

 See [Assigning Channels Using Multi-Assign](#) and [Assign VCAs and Mute Groups from Channel Control Encoders](#) for instructions on assigning channels to VCAs.

VCAs can also be used to trim Aux send levels. See [VCAs Trim Aux Sends in Sends on Faders Mode](#).

Banking VCAs

You can bank VCAs to control surface faders in Split Banking mode and VCAs Fader Bank mode.

 [Spill Mode for Outputs](#) provides another way to bank channels assigned to VCAs.

To bank VCAs in Split Banking Mode:

- 1 De-select a Fader Bank mode switch if one is enabled to enter Split Banking mode.
- 2 In the Left Soft Keys display, if necessary press the lit **Next** switch until you the VCAs you want to bank in the Soft Keys display

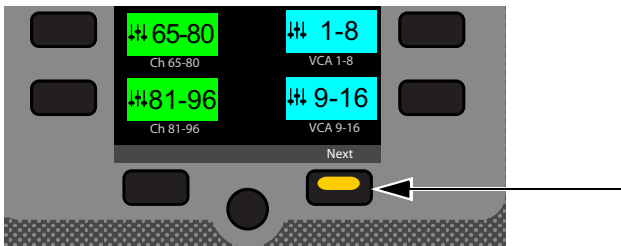

Lit Next switch

- 3 Press a VCAs Soft Key so it lights. The selected VCAs are banked to the faders on the center fader bank (under the MLM).

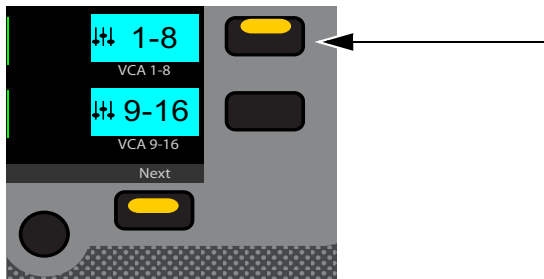

VCA 9-16 Soft Key

- 4 Do any of the following to adjust a VCA's parameter:
 - Adjust the fader to adjust VCA level.
 - Press the channel strip **Mute** switch to implicitly mute member channels.
 - Press a channel strip **Solo** switch to solo the VCA.

 For more information see [Explicit and Implicit Channel Mute with Mute Groups and VCAs](#).

To bank VCAs in Fader Bank mode:

- 1 Press the **VCA** Fader Bank mode switch so it lights.
VCAs 1–24 (for the S6L-24/24D) or VCAs 1–32 (for the S6L-32D) are banked to all the faders on the control surface.
- 2 To bank VCAs 25–32 on the S6L-24/24D, press the corresponding Soft Key.
– or –
 - Use the Horizontal Banking switches to nudge channels left or right, as desired (see **Banking Horizontally (Nudging Channels)**).

VCA Members on MTS/CTM Meters View

VCA members are shown in Meters view for VCAs.

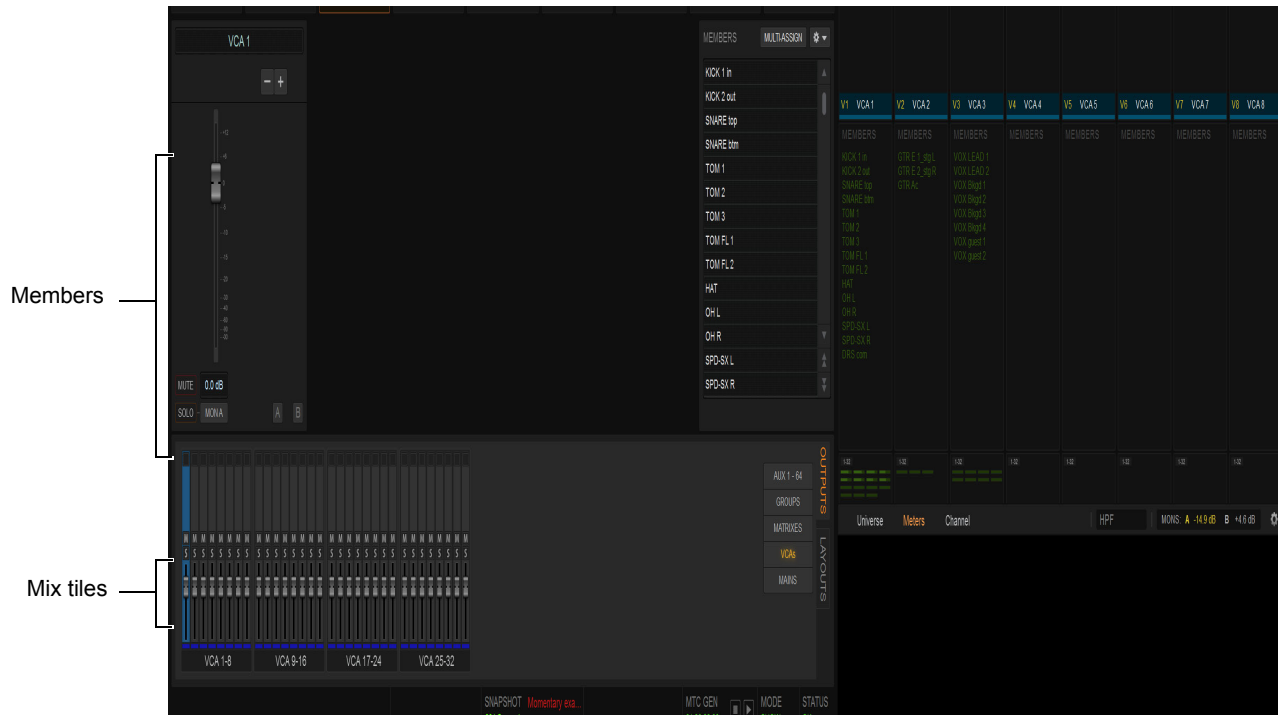

VCAs in Meters view

If the VCA has 22 or more member channels you can scroll the list by swiping up and down.

Tapping a Mix tile (below each VCA/list) targets those members to the CKM. The currently targeted Mix tile is outlined in orange.

Channel Strips Show VCA Contribution

The *effective gain* of any channel is equal to the combination of its individual channel fader, plus any (all) VCA level changes that affect that channel.

Input and output channels display the net effect of VCA level (effective gain) on-screen. This lets you keep track of what all currently assigned VCAs are doing to channels and buses at all times.

On-Screen VCA Indication

VENUE displays effective gain as a second, red “ghost” fader caps below the faders of channels that are currently assigned to one or more VCAs.

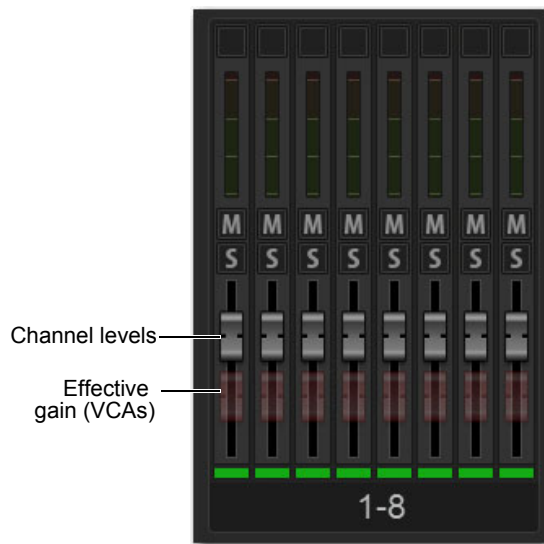

VCA contribution shown in the on-screen fader displays

The opacity of the ghost caps vary with the actual VCA levels:

- Lighter caps indicate smaller amounts of VCA contribution.
- Brighter caps indicate larger amounts of VCA contribution.

Turning Channel VCA Indication On and Off

By default, channel VCA indication is on. You can turn off VCA indication on the Options > Interaction page of the external screen.

To turn channel VCA indication off or on:

- 1 On the external screen, go to Options > Interaction.
- 2 In the Fader Configuration section, select or de-select Show VCA Contribution as desired.

Working with Aux Sends

This chapter covers how to work with Aux Sends and covers the following:

- [Adjusting Aux Sends in Channel Control Mode](#)
- [Adjusting Aux Sends in Channel Strip Mode](#)
- [Adjusting Aux Sends on Faders \(Sends on Faders Mode\)](#)
- [VCAs Trim Aux Sends in Sends on Faders Mode](#)
- [Adjusting Aux Sends on the External Screen](#)
- [Classifying Auxes for Snapshots](#)

Adjusting Aux Sends in Channel Control Mode

When accessing Aux Sends in Channel Control mode, the number of available Aux Sends, and the Mix switch or touch zone used to spill the sends to the CKM encoders, depends on the overall Mix Bus configuration. See [Configuring Mix Buses](#).

In Channel Control mode, Aux Sends are spilled to CKM encoders sequentially from left to right, and top to bottom. After spilling Aux Sends, you can toggle the sends on/off, adjust send levels, and toggle sends pre-/post-fader using the encoders. You can set the Aux send pre-fader pickoff point on a per-channel basis (see [Selecting Aux Pre-Fader Pickoff Points](#)).

You can also access Aux Sends 1–4 in Channel Strip mode (see [Adjusting Aux Sends in Channel Strip Mode](#)).

To spill Aux Sends using the MIX Channel Control Function switches:

- 1 Bank the desired channels.
- 2 Select one or more channels.
- 3 Press a **MIX** switch to spill the following Aux Sends to the encoders on the associated CKM, as available:
 - The left **MIX** switch spills Aux Sends 1–32.
 - The center **MIX** switch spills Aux Sends 33–64.
 - The right **MIX** switch spills Aux Sends 65-96.

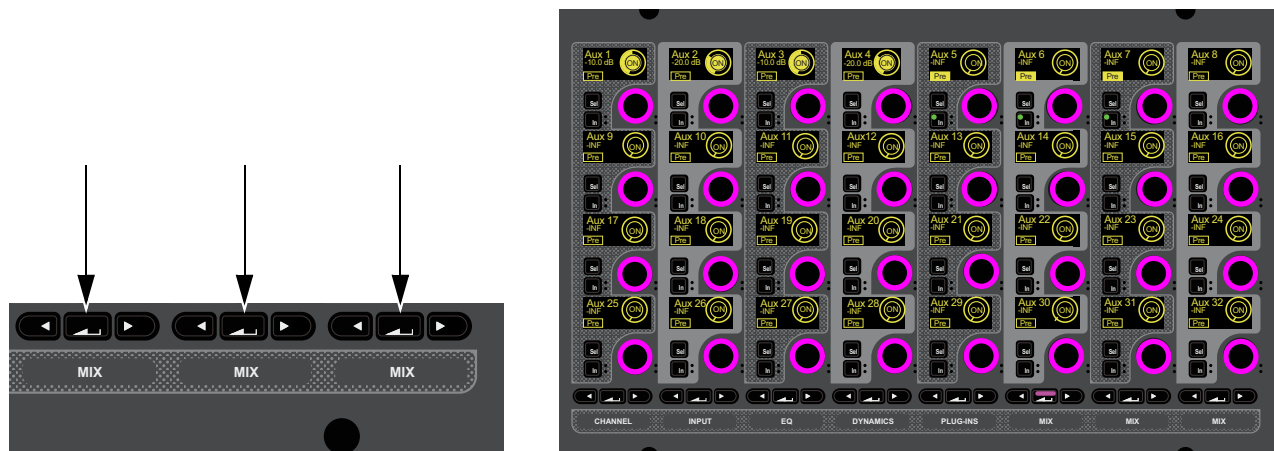

MIX Channel Control Function switches (left) and the Aux Sends 1–32 spilled to the encoders (shown at right)

To spill Aux Sends using the CTM in Meters view:

- Touch the Aux Sends touch zone on the associated CTM. The Aux Sends that are spilled are indicated by the channel number range at the top of the touch zone.



CTM Meters view (left) and a closeup of the Aux Send touch zone

To spill Aux Sends using the CTM in Channel view:

- 1 If necessary, in Meters view touch the Meters for the channel you want to access in Channel view.
- 2 Touch one of the three Aux Sends touch zones in the Aux Sends section on the associated CTM. The active zone is bordered in red. Each zone spills the following Aux Sends to the CKM encoders, as available:
 - Zone 1 (topmost zone) spills Aux Sends 1–32.
 - Zone 2 (middle zone) spills Aux Sends 33–64.
 - Zone 3 (bottom zone) spills Aux Sends 65-96.



Aux Sends touch zones in CTM Channel view (80 Aux configuration shown)

To toggle an Aux Send on/off:

- Press the encoder under the display showing the Aux Send you want to adjust, such as Aux 1. On is shown in the encoder display when the send is on. Off is shown when the send is off. On-screen, the thermometer-style level indicator for each Aux Send lights when Aux Send is on, and is dimmed when off.

To adjust Aux Send level:

- Rotate the encoder under the display showing the desired Aux Send.
Send level is shown in the corresponding encoder display. On-screen, thermometer-style level indicators in the Aux Sends zones show Aux Send level.

To toggle an Aux Send pre-/post-fader:

- Press the encoder **In** switch under the display showing the desired Aux Send. The following elements indicate that an Aux Send is pre-fader:
 - The corresponding encoder **In** switch lights.
 - Pre or Post is shown in the corresponding encoder display.
 - On-screen, a border appears around the channel numbers.

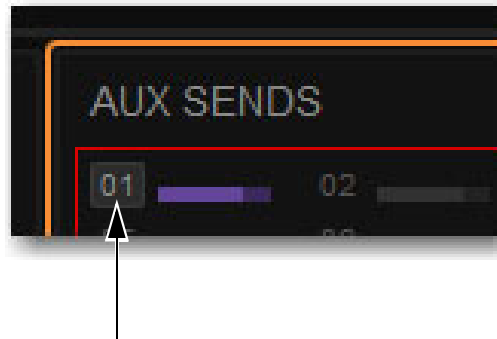
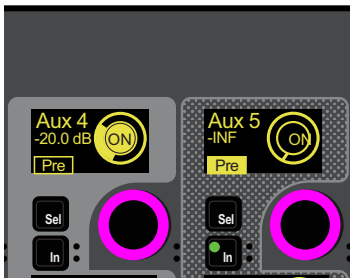

CKM encoders showing the various Aux Send states (left) and indication of a pre-fader Aux on the CTM (right)

Selecting Aux Pre-Fader Pickoff Points

Each Aux Send can be set as pre- or post-fader. You can specify the pre-fader pickoff point for Aux buses.

Pre-Fader pickoff points are set for each bus independently. If any buses are stereo, the pickoff point is set for the stereo pair. The following pre-fader pickoff points for Aux buses are available:

Pre-EQ Post-HPF/LPF and pre-EQ, Dynamics and Channel Inserts, pre-Mute, and pre-Fader. The Aux send is not affected by the channel mute.

Pre-EQ Post-Mute Post-HPF/LPF and pre-EQ, Dynamics and Channel Inserts, post-Mute, and pre-Fader. The Aux send is affected by the channel mute.

Pre-Mute Post-HPF/LPF, post-EQ, Dynamics, and Channel Inserts, pre-Mute, and pre-Fader. The Aux send is not affected by the channel mute.

Pre-Fader Post-HPF/LPF, post-EQ, Dynamics, and Channel Inserts, post-Mute, and pre-Fader. The Aux send is affected by the channel mute.

To set the pre pickoff point for an Aux send:

- 1 On the external screen, go to Options > Buses.
- 2 Select an Aux Select Button button to access those Auxes in the grid.
- 3 In the Auxiliaries section, select the Pre-EQ, Pre-EQ Post Mute, Pre-Mute, or Pre-Fader button so it lights.

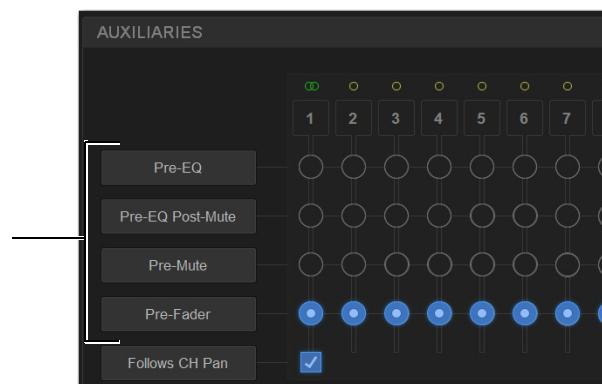

Aux bus pickoff points

Adjusting Stereo Sends in Channel Control Mode

You can combine any two Aux outputs into a single stereo Aux output using Make Stereo (see [Make Selected Mono Strips Stereo/Make Selected Stereo Strip Mono](#)). With stereo Auxes, you can pan send signals across the stereo pair, or panning can follow channel pan (enabled per-Aux on the Options > Buses page of the external software).

On CKM encoders, stereo Aux Send controls are combined into one encoder, which controls both level and pan.

 *When two Aux outputs are made stereo, no blank strips are created or inserted, and channels in the layout in that bank are shuffled to the left, including the corresponding Aux Sends.*

To adjust a stereo Aux Send in Channel Control mode:

- 1 Bank to and select the desired channel.
- 2 Press the appropriate **MIX** Channel Control Function switch or CTM touch zone to access the desired stereo Aux Send.
The stereo send is available on a single encoder.
- 3 To adjust stereo Aux Send level, rotate the encoder.
- 4 To adjust send pan, do the following:
 - Press the corresponding encoder **Sel** switch so it lights. Send pan is now targeted to the corresponding encoder, the color in the corresponding encoder display inverts, and P <Aux number/name> and pan value appears in the display.
 - Rotate the encoder to adjust send pan.



CKM encoder showing Aux Send pan targeted to the encoder

Adjusting Aux Sends in Channel Strip Mode

You can control Aux Sends 1–4 on the CKMs in Channel Strip Mode.

To adjust Aux Sends in Channel Strip mode:

- 1 Bank the desired input or output channels.
- 2 Do either of the following to enable Channel Strip mode:
 - Press a lit **Select** switch to de-select it and enable Channel Strip mode on the associated CKM.
 - Press **Select Clear** to de-select all channels on the control surface and enable Channel Strip mode on all CKMs.
- 3 Navigate to the Aux Send Channel Strip mode parameter bank by pressing lit Parameter Bank switches, as available, until the encoders appear purple.
Aux Sends 1–4 appear on the fifth page of Channel Strip mode parameters.

To toggle an Aux Send on/off:

- Press the encoder under the display showing the Aux Send you want to adjust, such as Aux 1.
On is shown in the encoder display when the send is on. Off is shown when the send is off.

To adjust Aux Send level:

- Rotate the encoder under the display showing the desired Aux Send.

To toggle an Aux Send pre-/post-fader:

- Press the encoder **In** switch under the display showing the desired Aux Send. The following control and on-screen elements indicate that an Aux Send is pre-fader:

To adjust stereo send pan:

- 1 Press the corresponding encoder **Sel** switch so it lights. Send pan is now targeted to the corresponding encoder and P <Aux number/name> and pan value appears in the corresponding encoder display.
- 2 Rotate the encoder to adjust send pan.

Adjusting Aux Sends on Faders (Sends on Faders Mode)

The S6L system provides a Sends on Faders mode to facilitate monitor mixing workflows. Sends on Faders mode is available in two forms, *Direct*, and *Sends on Faders Follows AFL*.

Direct Sends on Faders Enabling the Sends on Faders button in the Universe View on the MTS lets you select any Aux to assign its members' sends (channels assigned to/feeding that Aux) to the faders, without soloing the Aux. Unlike spilling an Aux, Direct Sends on Faders does not bank or change input strips.

Sends on Faders Follows AFL In Sends on Faders Follows AFL mode, soloing an Aux output simultaneously assigns its sends to the faders and routes the Aux output's signal to the Monitor bus. This lets you simultaneously monitor the Aux output mix and adjust its send levels using the faders with the press of a switch or the touch of an on-screen button. You must enable Sends on Faders Follows AFL functionality on the Options > Busses page of the external screen.

Sends on Faders mode only affects input channels. It does affect *all* input channels, however. If no input channels are banked when Sends on Faders is activated, all "hidden" input channels also enter Sends on Faders mode. When banking to other input channels, Sends on Fader mode remains enabled for the newly banked channels.

Associated CKMs remain unaffected in Sends on Faders Follows AFL mode, so all Channel Control or Channel Strip mode functions for the banked channels remain freely available.

 **Spill Mode for Outputs** provides another way to bank channels assigned to Auxes.

Using Direct Sends on Faders Mode

To use Direct Sends on Faders from the MTS:

- 1 Bank input channels to the faders in any fader banking mode, or bank a User Layout that includes input channels. You can activate Sends on Faders in Split Banking mode, and Inputs and Layouts Fader Bank mode.
- 2 On the MTS, touch Universe, then touch Auxes to show Aux channel tiles.
- 3 On the MTS, tap to enable the Sends on Faders Channel Tile Function button.

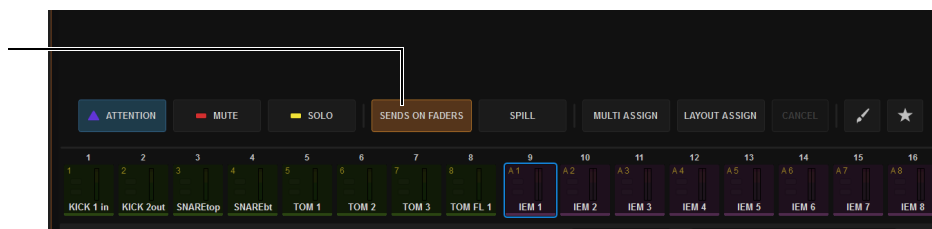

Sends on Faders button enabled in Universe > Auxes

- 4 Tap the Channel Tile for the Aux output whose sends you want to adjust. The channel displays show SOF and the number or name of the Aux output.

 See also **Position Safe When Spilling**.



Channel display for an input channel in SOF mode

- 5 To adjust the level of a channel assigned to the current Aux, adjust its fader or SOF knob (if the Aux is mono) on the associated CKM.

- 6 To adjust other Send parameters do the following using the SOF controls in row 4 on the associated CKM:
- To enable or disable channel assignment to the current Aux, press the CKM knob.
 - To toggle the Aux between Pre and Post, press the knob **In** switch (when the **In** switch LED is lit it indicates Pre-fader).

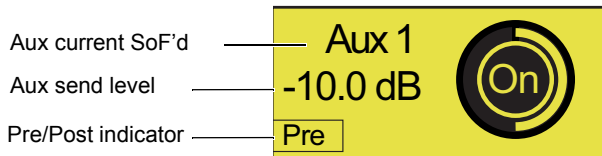

Channel display for an input channel in SOF mode

To access the sends of another Aux output do any of the following:

- On the MTS, tap another Aux output's Channel Tile to spill those Aux Sends to the faders.
- Press the Attention key on any other Aux strip.
- Attention another Aux using the external screen.

To exit Sends on Faders, do any of the following:

- On the MTS, tap to disable the Sends on Faders Channel Tile Function button.
- On the MLM, press the flashing **Cancel** switch.
- On the external screen, tap Exit Sends on Faders in the alert dialog.

Using Sends on Faders Follows AFL Mode

Sends on Faders Follow AFL mode lets you simultaneously monitor the Aux output mix and adjust its send levels using the faders with the press of a switch or the touch of on-screen button.

Sends on Faders Follow AFL must be enabled on each desired Monitor bus independently. Make sure to enable Sends on Faders Follows AFL on the Monitor bus that your input channels are currently routed to (assuming you want all input channels to be subject to Sends on Faders Follow AFL).

For example, you can route some of your input channels to Monitor bus A with Sends on Faders Follow AFL disabled, and route other channels to the other Monitor bus B with Sends on Faders Follows AFL *enabled*. You can then route each Monitor bus to a discrete hardware or headphone output.

 For more information on configuring your Monitor buses, see [Configuring the Monitor Buses and Solo Options](#).

If any input channels are targeted to *both* Monitor buses, then enabling Sends on Faders Follows AFL on either Monitor bus results in Sends on Faders behavior for that channel.

Enabling Sends on Faders Follow AFL

To enable Sends on Faders:

- 1 Go to the Options > Buses page of the external screen.
- 2 Under Monitor Bus A or Monitor Bus B, select Sends on Faders Follow AFL so it is checked.

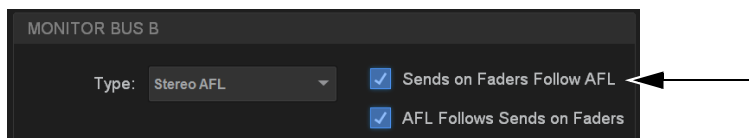

Sends on Faders enabled for Monitor Bus A

Accessing Aux Sends in Sends on Faders Follow AFL Mode

After enabling Sends on Faders Follow AFL, you can bank the Aux sends to faders by soloing an Aux output. You can activate Sends on Faders Follow AFL in Split Banking mode, and Inputs and Layouts Fader Bank mode. You can bank to other channels while in Sends on Faders Follow AFL mode, but you must stay within the current banking mode (Split Banking mode or Fader Banking mode) to remain in Sends on Faders Follow AFL mode. You can also access other sends for other Aux outputs while Sends on Faders Follow AFL is active.

To adjust Aux Sends on Faders:

- 1 Bank input channels to the faders in any fader banking mode, or bank a User Layout that includes input channels.
- 2 On the MTS, touch Universe, then touch Auxes to show Aux channel tiles.
- 3 Touch the Solo Channel Tile Function button so it lights.

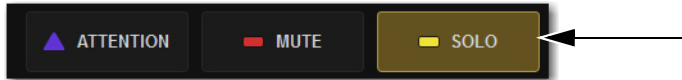

Solo Channel Tile function switch

- 4 Tap the Channel Tile for the Aux output whose sends you want to adjust.



You can also solo Aux outputs from the channel strips when Auxes are banked to the center fader bank in Split Banking mode, or by using the Solo button for the Aux output on the Outputs page of the external screen.

The channel displays show SOF and the number or name of the Aux output.



A Channel Tile showing a soloed Aux (left) and a channel display indicating Sends on Faders mode (right)

On the Universe view on the MTS, the Sends on Faders button lights.

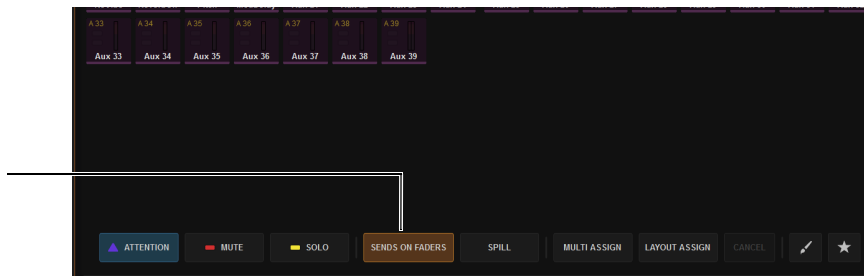

Indication of Sends on Faders enabled

- 5 Adjust the faders to adjust send levels.



See also [Position Safe When Spilling](#).

To access the sends of another Aux output:

- Solo another Aux output to spill those Aux Sends to the faders.
- Tap a different Aux tile on the MTS.

To exit Sends on Faders, do any of the following:

- Un-solo the currently soloed Aux output.
- On the MLM, press the flashing **Cancel** switch.
- On the external screen, tap Exit Sends on Faders in the alert dialog.

Adjusting Stereo Sends in Sends on Faders Modes

To adjust Aux Send pan in Sends on Faders mode, the fader bank from which you are adjusting pan must be in Channel Strip mode.

To adjust stereo sends in Sends on Faders modes:

- 1 Bank to the desired input channels.
- 2 Use Direct Sends on Faders, or solo a stereo Aux output while Sends on Faders Follows AFL is enabled, to enter Sends on Faders mode.
Aux Send pan for each banked channel is assigned to the bottom row of encoders in Channel Strip mode, and P <Aux number/name> appears in the encoder displays.
 - 3 Rotate the knob to adjust send pan for the corresponding channel.
 - Press the send pan encoder **In** switch to toggle that send pre-/post fader.



VCA's Trim Aux Sends in Sends on Faders Mode

The VCAs Trim Aux Sends in SOF setting in Options > Interaction lets you use VCAs to quickly trim multiple Aux Send levels (such as all drums, or all background vocals) while in Sends on Faders mode.

To use VCAs Trim Aux Sends in SOF:

- 1 Go to Options > Interaction and make sure VCAs Trim Aux Sends in SOF is enabled (its default setting).
- 2 Assign channels to Auxes and set their preliminary send levels.
- 3 Make sure you have assigned channels to VCAs.
- 4 Place an Aux into Sends on Faders mode. (For instructions, see the *VENUE S6L System Guide.pdf*)
The Input channel displays show SOF and the number or name of the Aux output.
- 5 Bank VCAs to fader strips.
 - To access 8 Aux VCAs at a time, press a VCA soft key in the left bank of MLM Soft Keys.
 - To access Aux VCAs across all fader strips, press the **VCAs** banking switch on the MLM.The corresponding (VCA) fader strip displays show SOF VCA, the number and name of the VCA, and the number or name of the Aux being trimmed.

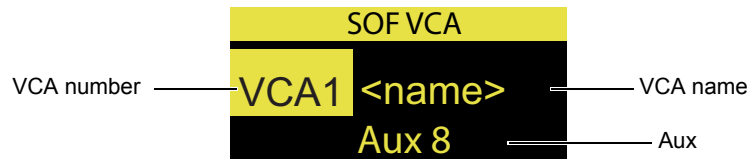

VCA display in Aux VCA mode

Faders on SOF VCAs locate to 0 (unity). Trims made with SOF VCAs directly change the corresponding Aux send levels (changes are not stored in the Show file). After exiting and re-entering SOF VCA mode, VCA faders again locate to 0 (unity).

 *When VCAs are in SOF VCA mode the blue "0" LED does not light, to indicate that SOF VCA mode is enabled.*

- 6 Adjust a VCA to trim the corresponding Aux Send levels.
SOF VCA mode is designed to make small trim adjustments. Note that any offsets between channel Aux send levels can be lost if the SOF VCA is lowered or raised to extremes.

Adjusting Aux Sends on the External Screen

You can toggle individual sends on/off and pre-/post-fader, as well as view send level and pan (for stereo sends) for the attentioned channel on the Inputs page of the external software.

 For more information on working with channels on the external screen, see [Adjusting Parameters on the External Screen](#).

To adjust Aux Sends on the external screen:

- 1 Go to the Inputs page.
- 2 Select the Inputs tab, then select the bank of input channels you want to access using the Input Channel Type buttons.

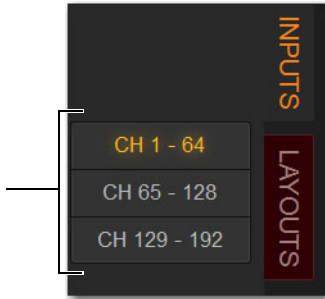

Input Channel Type buttons

- 3 Attention an input channel.
- 4 To toggle an Aux Send on/off, select the thermometer-style indicator. When the indicator lights, the send is on. The indicator lights in the color assigned to that Aux output.

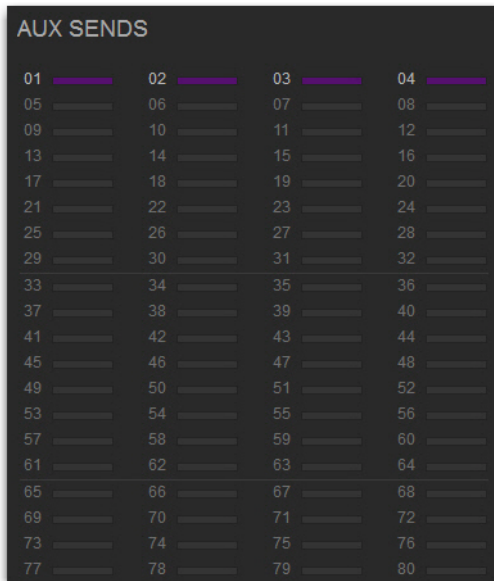

Inputs page Aux Sends section showing Auxes 1–4 enabled for the attentioned channel(s)

Expanded Aux Sends View on the External Screen

The Inputs page provides an expanded Aux Sends view that provides touch access to all Aux parameters. Auxes in Expanded Aux view can be sorted, and the display filtered by color, favorites, and In status.

To use Expanded Aux view (refer to the figures):

- 1 Navigate the external screen to the Inputs page.
- 2 Tap in the Auxes view within the range of 16 Auxes you want to show in Expanded view. Or tap the Expand icon in the upper right corner of the Aux section to show the previously Expanded Aux view.
Expanded Aux view displays Auxes in banks of 16. All Aux parameters can be adjusted on the external screen.
- 3 To show a different bank of Auxes, select a tab (such as 17-32).
- 4 To control how and which Auxes are displayed, use the Filter buttons (123 or A-Z), color blocks, star, or IN (to show only Auxes that are on/enabled).
- 5 To make or change assignment to Mains, use the L-R and C/MONO buttons.

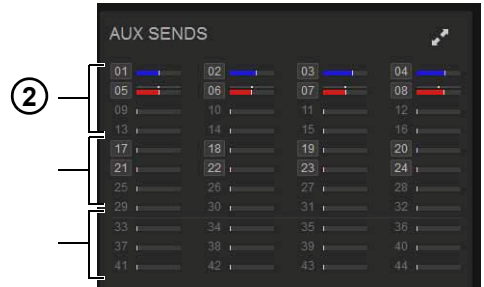

Aux Sends Touch zones in the Inputs page

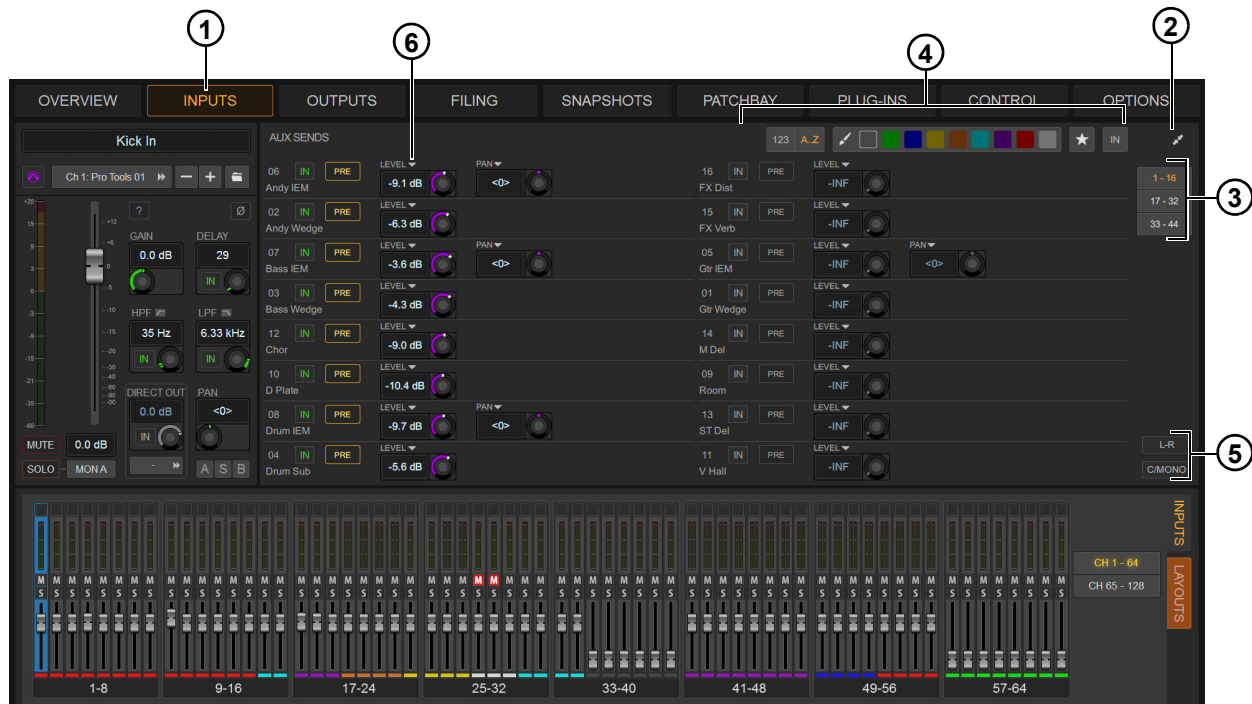

Expanded Aux view in the Inputs page

- 6 To access Reset and Channel Control Aux commands, tap the triangle above each Aux Level block and choose a command from the pop-up menu and sub-menu.
- 7 To close the Expanded Aux view, tap the Expand icon (“2” in the figure).

Classifying Auxes for Snapshots

You can classify Aux Sends as *monitor sends* (“Mon”) or as *effects sends* (“FX”) for the purposes of scoping and safing each type separately in snapshots. [Classifying Aux Sends](#). In addition, you can use the [User Aux Scope](#) tab to scope Auxes individually.

Matrix Mixers

This chapter covers using the S6L system’s Matrix Mixers, and includes the following topics:

- [Matrix Mixers Overview](#)
- [Assigning Input Sources to Matrix Mixers](#)
- [Adjusting Matrix Mixer Input Controls](#)
- [Delay Compensation with Matrix Mixers](#)
- [Adjusting Matrix Mixer Output Controls](#)
- [Snapshot Data and Parameters for Matrix Mixers](#)

Matrix Mixers Overview

The S6L system provides 16 (E6L-144) or 24 (E6L-192) mono Matrix Mixers for setting up alternate mixes, fill and delay feeds, and cue, monitor or press mixes.

Each of the available Matrix Mixers can receive up to 24 discrete input sources. Input sources can be any combination of input channels, Auxes, Groups, Monitor A or Monitor B, or Mains buses. Each Matrix Mixer has a mono output, but you can combine two Matrix Mixers into one stereo Matrix output using the Make Stereo command (see [Make Selected Mono Strips Stereo/Make Selected Stereo Strip Mono](#)).

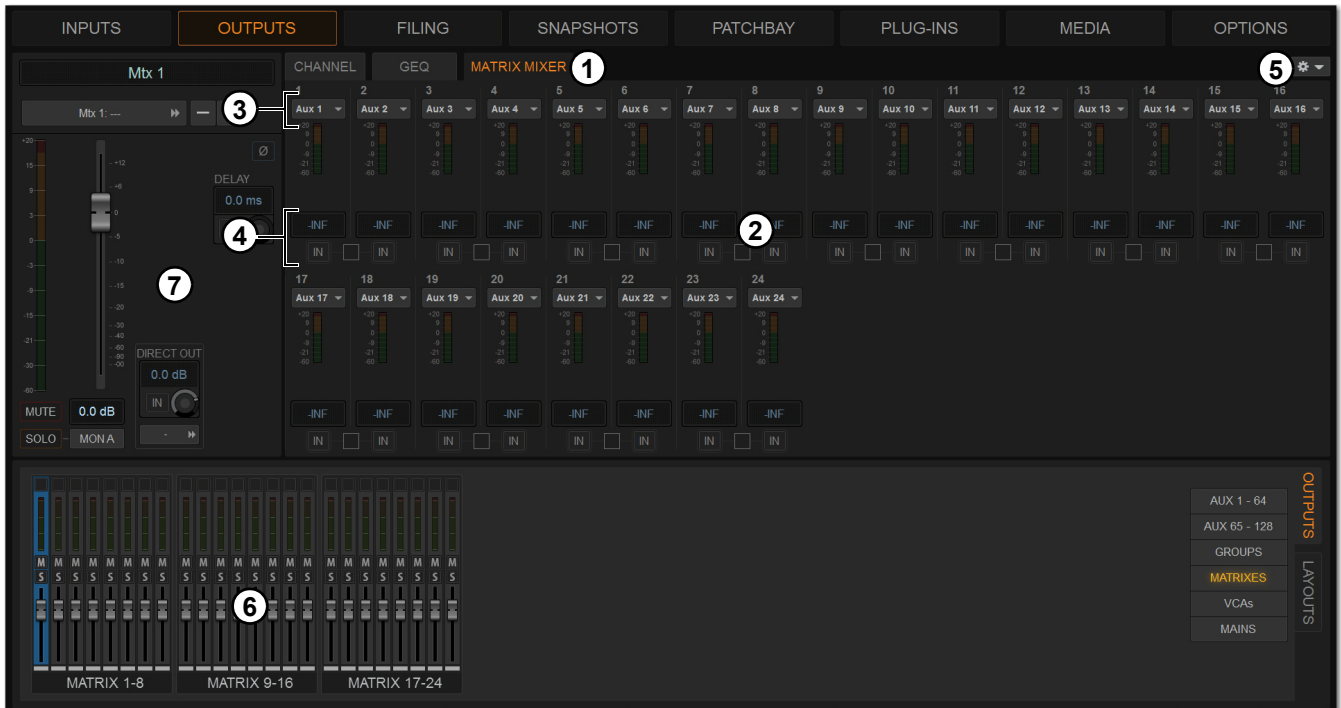

A Matrix Mixer on the Outputs page of the external screen

- | | |
|--|--|
| 1 – Matrix Mixer Tab | 5 – Matrix Mixer Reset/Clear Selector |
| 2 – Matrix Inputs | 6 – Matrix Mixer Output Fader Strips |
| 3 – Matrix Input Source Selectors | 7 – Matrix Mixer Output Controls |
| 4 – Matrix Input Controls | |

Assigning Input Sources to Matrix Mixers

Each Matrix Mixer can receive up to 24 discrete input sources. You can assign any combination of input channels, Auxes, Groups or Mains buses. Each Matrix Mixer has a mono output, but outputs can be linked to form a stereo pair. A variety of pickoff points are available when assigning Matrix input sources. Matrix input source assignments are made using the external screen.

Pickoffs for each input are selected when you select the input source. Matrix Mixers provide the following pickoff points for source channels:

Input Channels Top of channel, Insert Return, or Pre-Fader Post-Mute

Output Channels Pre-Fader Pre-Mute, or Post-Fader

Monitor Busses Pre-Fader Pre-Mute, or Post-Fader

 While either Monitor A or B are assigned to any Matrix, Solo on that Matrix is unavailable.

To assign input sources to a Matrix mixer:

- 1 On the external screen, go to the Outputs page.
- 2 Select the Outputs tab, then select the Matrixes Channel Type button.



Output Channel Type buttons

- 3 Attention the desired Matrix Mixer(s).

 You can use Multi-Select to attention multiple Matrix Mixers and apply the same input source to all selected Matrixes.

- 4 Select the Input Source selector at the top of each Matrix channel
- 5 For each input source, choose the following:
 - Choose the desired input source.
 - Choose the desired channel.
 - Choose from the available pickoff points.

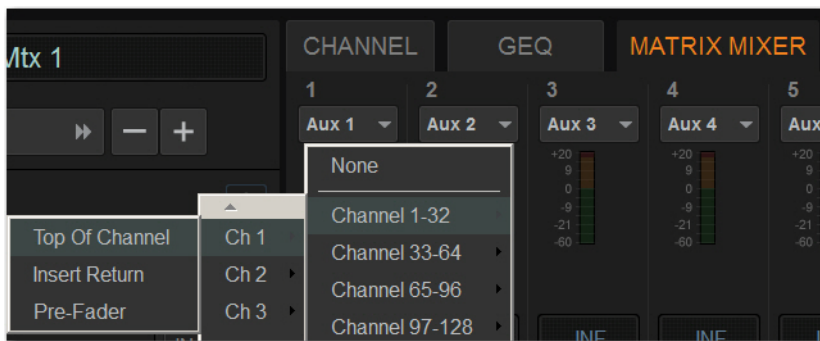

Matrix Mixer input source menu showing input sources, channels, and pickoff points

Adjusting Matrix Mixer Input Controls

You can adjust Matrix Mixer input levels using the CKM in Channel Control mode, or the external screen.

Adjusting Matrix Mixer Input Level

To adjust Matrix Mixers input levels:

- 1 Bank Matrixes to the faders.
- 2 Select a banked Matrix.
- 3 Press any **MIX** Channel Control Function switch on the associated CKM.
– or –
 - Touch the Matrix Mixer touch zone on the associated CTM in Meters or Channel view.



Matrix Mixer touch zone on the CTM in Channel view

The selected Matrix Mixer's input controls are spilled to CKM encoders. The source for each Matrix Input is shown in the corresponding encoder display. The encoders for the different inputs are colored according to their global color-coding setting.

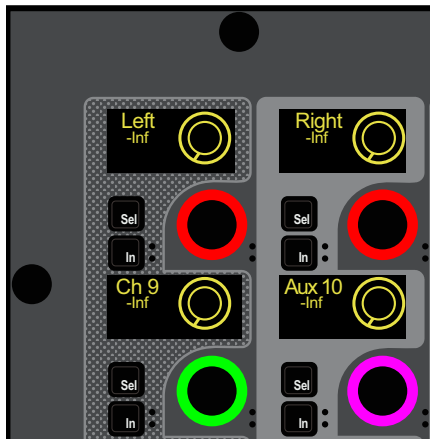

Matrix Mixer input sources on the CKM encoders

- 4 To toggle an input on/off, Press the encoder under the display showing the Matrix Mixer input you want to adjust.
The corresponding encoder **In** switch lights green when the input is on. On the CTM in Channel view, and the MTS in Meters and Channel views, thermometer-style level indicators light when the input is on, and is dimmed when off.
- 5 To adjust input level, rotate the encoder under the display showing the desired Aux Send.
Input level is shown in the corresponding encoder display, on the CTM in Channel view, and on the MTS in Meters and Channel views.

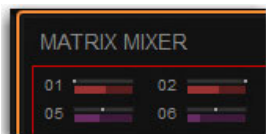

Matrix Mixer input levels shown on the CTM in Channel view

To enter an input levels on the external screen:

- 1 On the Matrix Mixer tab, touch the input level field.
- 2 Type in an amount using the keyboard, and then press Enter.

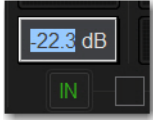

Entering a Matrix Mixer input level using a keyboard

Linking and Unlinking Adjacent Matrix Inputs

Adjacent inputs to Matrix mixers can be linked or unlinked on a per input pair basis. Link status can be specified on a per Matrix basis (for example, inputs 1 and 2 can be linked for Matrix 1, but unlinked for Matrix 2). This gives you the ability to control inputs as either a stereo-linked pair or as independent mono inputs.

- When linked, level and source on/off controls are linked.
- When unlinked, discrete level and on/off controls affect each individual channel.

To link or unlink inputs to Matrix mixers:

- 1 On the external screen, go to the Outputs page.
- 2 Select the Outputs tab, then select the Matrixes Channel Type button.
- 3 Select the checkboxes below any adjacent inputs to link or unlink them. A check mark in the checkbox indicates a linked input source; an empty checkbox indicates unlinked sources.

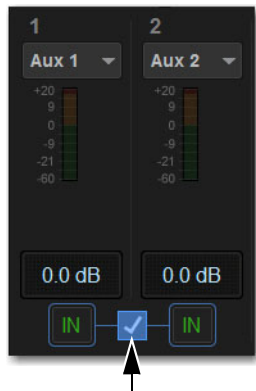

Matrix link button

Matrix Mixer Input Pan

Matrix mixer input pan controls adjust the panning of each Matrix mixer input across the stereo outputs of a stereo Matrix Mixer.

To control Matrix send pan from the Global Control encoders:

- 1 Assign the Matrix mixer input source to Global Control for the stereo Matrix you want adjust.
- 2 Press the encoder **Sel** switch to assign send pan control to the encoder.
- 3 Adjust the encoder to adjust pan.
 - Rotate to the left to pan the input source to the left (odd-numbered) Matrix mixer.
 - Rotate to the right to pan the input source to the right (even-numbered) Matrix Mixer.

Resetting Matrix Mixer Input Parameters

You can reset level, pan and stereo link settings for any matrix mixer. Input source assignments persist.

To reset a Matrix mixer parameter to its default value:

- 1 Attention one or more Matrix mixers you want to change.
- 2 Touch-and-hold (right-click) the encoder on-screen and choose **Reset**.

To reset all Matrix mixer parameters to their default values:

- 1 Attention one or more Matrix mixers you want to change.
- 2 Select the Matrix Mixer Reset/Clear Selector at the top right of the Matrix Mixer, and choose **Reset Mix**.

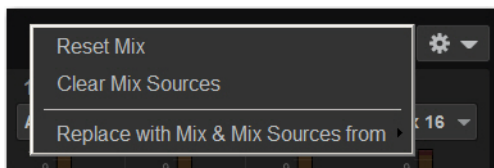

Matrix Mixer Reset/Clear menu

Clearing Matrix Mixer Input Assignments

You can clear mixer input assignments to quickly set all the input sources to None.

To clear Matrix input assignments:

- 1 Attention one or more Matrix mixers you want to change.
- 2 Select the Matrix Mixer Reset/Clear Selector and choose **Clear Mix Sources**.

Copying Matrix Mixer Input Settings

You can copy mixer settings from one Matrix mixer to another mixer of the same type. This lets you quickly duplicate monitor mixes or other signal feeds.

⚠ *Copying mixer settings overwrites all the settings on the destination mixer.*

To copy settings between mixers:

- 1 Attention the Matrix mixer that you want to be the destination of the copied settings so that it is displayed on-screen.
- 2 Select the Matrix Mixer Reset/Clear Selector and choose **Replace With Mix and Mix Sources From**.
- 3 Choose the Mtx (Matrix mixer) from the sub-menu whose settings you want to copy to the current Matrix Mixer.

Delay Compensation with Matrix Mixers

VENUE automatically compensates for the delay offsets that can arise when combining different signal paths within a Matrix mixer.

Additional Information about Delay Compensation

- The overall latency through a Matrix is determined by the path with the highest latency.
- All inputs within a Matrix mix are guaranteed to be phase accurate, but mixes are not necessarily aligned to each other. This ensures that all mixes are not penalized in the case of one or more exceptionally high-latency signal paths.
- Delay compensation only accounts for a channel's post-insert pickoff. Channels that feed User Inputs and Auxes (pre-insert) will not be fully compensated for.
- Any latency associated with Monitor buses is *not* included in the calculation of delay compensation for the corresponding Matrix.

Adjusting Matrix Mixer Output Controls

You can bank Matrix Mixer outputs to the S6L's faders and adjust level, solo, and mute using the channel strips. You can select Matrix Mixers to adjust built in EQ and dynamics using the encoders on the associated CKM in Channel Control mode.

Each Matrix Mixer features the same output processing capabilities as other output channels: a built-in 7-band parametric EQ, a built-in compressor/limiter, four plug-in slots (and one hardware insert slot), and the ability to insert a built in 31-band graphic EQ.

Accessing Matrix Mixer Output Processing on the External Screen.

You can adjust Matrix Mixer output parameters using the external screen, or by spilling them to the faders.

To access Matrix Mixer processing parameters on the external screen:

- 1 On the external screen, go to the Outputs page.
- 2 Select the Outputs tab, then select the Matrixes Channel Type button.



Output Channel Type buttons

- 3 Attention the desired Matrix Mixer(s).
- 4 Select the CHANNEL tab to access built-in channel EQ and Comp/Lim
- 5 Select the GEQ tab to insert and adjust built-in GEQs. For more information see [Adjusting Parameters on the External Screen](#).

To spill Matrix Outputs to the faders:

- See [Spill Mode for Outputs](#).

Snapshot Data and Parameters for Matrix Mixers

Snapshots can store and recall all source assignments of each matrix mixer when the Matrix (“Mtx”) data type is scoped, as shown in the following table.

Table 1. Snapshot data types and parameters for Matrix mixers

Snapshot Data Type	Included Parameters (for Each Scoped Channel Strip)
MTX	Mixer Input Sources and pickoffs; Mixer Input level, Mixer Input on/off state and Mixer <i>Input</i> Link state

The Recall Safe tab of the Snapshots page provides two data “Mix” data types that let you discretely “safe” source and/or user input assignments to prevent them from being changed with a snapshot recall.

For complete information on VENUE snapshots, see [Snapshots](#).

Muting and Mute Groups

Channels can be muted on the S6L system in two ways:

Explicitly Using the channel strip **Mute** switch on the control surface, from the MTS, or from the fader strips on the Inputs and Outputs pages of external screen. Mute switches light solid red when they are explicitly muted.

Implicitly As a member of a Mute Group or VCA, or when any other channel is soloed in SIP (Solo in Place) mode. Mute switches flash when they are implicitly muted.

This chapter shows how to do the following:

- Mute Individual Channels
- Use Mute Groups

Muting Individual Channels

Explicit Mute

You can mute individual channels using the channel strip **Mute** switch, from the MTS, or from the external screen. Muting individual channels always behaves in additive (latched) fashion. You can mute individual channels in any sequence, and they will remain muted until they are un-muted. Muting individual channels always mutes them *explicitly*.

Channel mute has the following characteristics, depending on the type of channel muted.

Input Channels Channel mute is pre-fader on input channels.

Output Channels Mute operation is post-fader on all types of Output buses.

Mains Only the linked Main buses are muted/unmuted. See [Linking/Unlinking Mains](#).

VCAs When you mute a VCA, its member channels are muted. The VCA mute indicator lights solid red, and the member channel Mute indicators flash to show they are muted as part of a VCA.

To toggle mute on individual channels from the channel strip:

- 1 Bank to the desired channels.
- 2 Press the **Mute** switch.
Mute lights solid red to indicate the channel is muted.

To toggle mute on individual channels from the MTS:

- 1 Touch Universe to show the Universe view.
- 2 Touch a Channel Tile Type button (Inputs, Auxes Groups, Matrixes, VCAs or Mains) to access the desired channel(s) on the MTS.
- 3 Touch the Mute Channel Tile Function button.

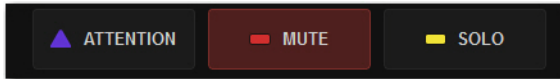

Mute Channel Tile Function button

- 4 Touch a Channel Tile.
The Channel Tile is bordered in red and the Channel Tile Mute LED lights solid red to indicate the channel is muted.



A Channel Tile showing a muted input channel

To toggle mute on individual channels from an external screen fader strip:

- 1 Select the Overview, Inputs, or Outputs page.
- 2 Select the Mute button on the desired channels' fader strip so it is lit.

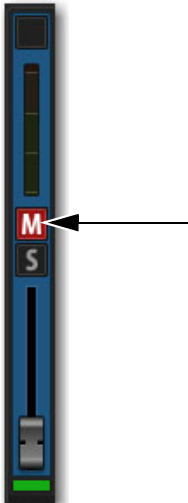

Fader strip Mute button enabled

Mute Groups

Mute Groups let you mute and un-mute multiple channels simultaneously by pressing a single switch. This section shows how to assign channels to Mute Groups, and toggle them on/off.

 *Mute Groups only affect the status of channel Mute switches, and do not affect the on/off status of Aux Sends, output of the Talk-back/Oscillator section, or the routing of signals to the monitor outputs.*

Assigning Channels to Mute Groups

You can assign any types of channels to Mute Groups except VCAs. You can also assign a Channel to multiple Mute Groups. Channels can be assigned and managed in the Mute Groups tab of the Control page on the external screen, where you can also give Mute Groups custom names. You can also assign channels to Mute Groups using the MTS, or from the channel encoders in Channel Control mode.

Assigning and Managing Mute Groups in the Mute Groups Tab

The Control tab provides a Mute Groups sub-tab in which you can manage assignments and name your Mute Groups.

To access the Mute Groups tab:

- Navigate the external screen to Control > Mute Groups.

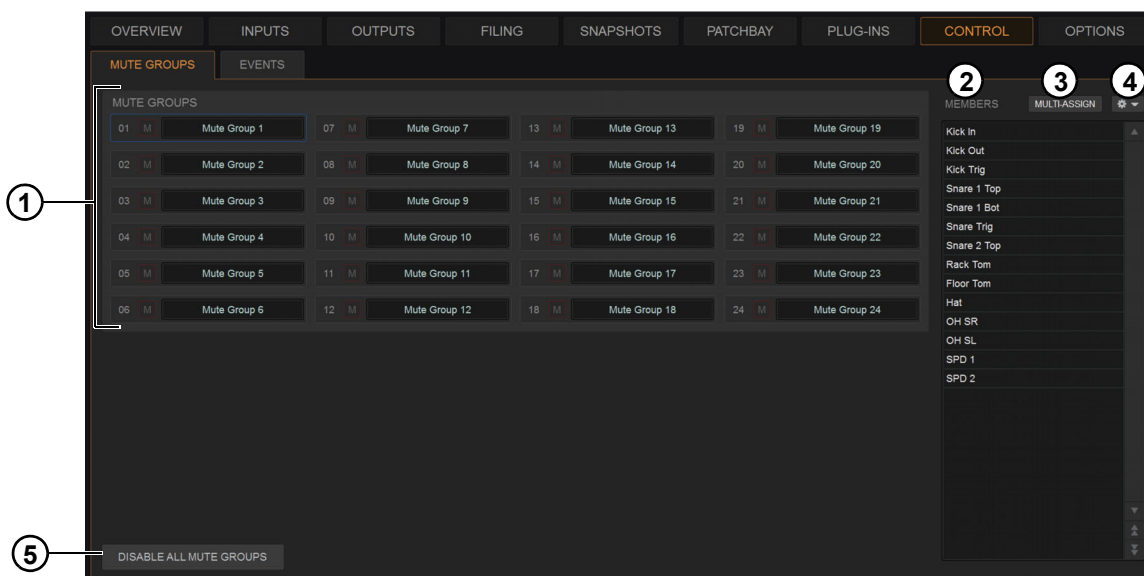

Control > Mute Groups

The Mute Groups tab provides the following features as shown in the figure above.

Mute Groups tab

	Item	Description
1	Access to up to 24 Mute Groups	24 selectable Mute Groups, each with Mute button and editable name
2	Members list	List of channels assigned to the currently selected Mute Group
3	Multi-Assign button	Enables/disables Assign to Mute Groups mode
4	Settings cog (gear icon)	Commands to manage Mute Group assignments
5	Disable All Mute Groups button	To disable (suspend) and re-enable all Mute Groups

To select a Mute Group:

- Click its box in the Mute Groups tab. The selected Mute Group becomes outlined in blue and the **Members** list shows all channels assigned to that Mute Group.

To name a Mute Group:

- 1 Double-click any Mute Group name (such as Mute Group 1).
- 2 Enter a custom name and press Enter.

Mute Group names are shown on the MLM in the left column of the right Soft Keys.

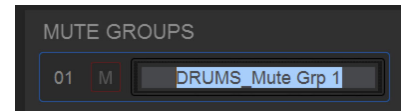

Entering a custom name for a Mute Group

To assign channels to the selected Mute Group:

- 1 Select the Multi-Assign button above the Members List.
- 2 Select the desired channels (on the control surface or on-screen) then press the flashing Multi-Assign button to confirm.

To toggle a Mute Group (mute/unmute its channels) from the external screen:

- On the external screen, press the Mute button for that Mute Group.

You can also toggle a Mute Group on/off using the Right Soft Keys on MLM. Mute Groups 1–6 are available from the first page of the Right Soft Keys menu. Mute Groups 1–24 are available on the Mute Group sub-pages.

To toggle Mute Groups using the MLM:

- 1 In the left-hand column of the Right Soft Keys display, locate any Mute Group 1–6 that you want to activate.
To access all Mute Groups (1–24) press the Mute Groups key in the right-hand column of the Right Soft Keys display.
- 2 To turn a Mute Group on, press the corresponding Soft Key so it lights.
- 3 To turn the Mute Group off, press the corresponding Soft Key so it is unlit.

To disable all Mute Groups from the external screen:

- In Control > Mute Groups, press Disable All Mute Groups.
The Disable All Mute Groups button lights red and the Mute Groups alert appears on the external screen. To enable Mute Groups press Disable All Mute Groups again (it becomes unlit) or press Enable Mute Groups in the on-screen alert.

To create a new Mute Group with the members of an existing Mute Group:

- 1 Select the Mute Group you want to define.
- 2 Click the Settings cog (gear icon) and choose Replace with Members from, then choose an existing Mute Group from the hierarchical sub-menu.

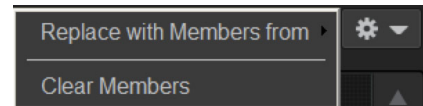

Mute Groups menu

To remove a member from a Mute Group:

- 1 Right-click the channel in the Mute Group Members list and choose Unassign.

To clear a Mute Group:

- 1 Select the Mute Group you want to clear.
- 2 Click the Settings cog (gear icon) and choose Clear Members.

To attention a member of a Mute Group:

- Select the channel in the Mute Group Members list.

Assigning Channels to Mute Groups Using the MTS and Channel Strips

To add or remove members of a Mute Group:

- 1 On the MTS, touch Mutes.



Mute Channel Tile Types button

- 2 Touch the Attention Channel Tile Function button.

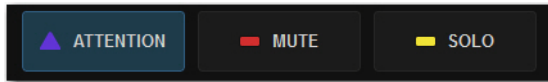

An enabled Attention Channel Tile Function button

- 3 Touch the desired Mute Group Channel Tile so it is bordered in blue (attentioned) to target that Mute Group for the assignments. The text in the upper left corner of the Channel Tile (such as MG 1 and MG 2) indicate the Mute Group number the Channel Tile corresponds to.



An attentioned Mute Group Channel Tile

- 4 Touch Multi-Assign on the MTS.

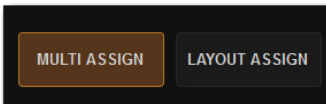

Enabled Multi-Assign button on the MTS

In the banner display on the external screen, a message appears indicating that the system is in Mute Group assign mode.



Banner Display message indicating that Mute Group assign mode is active

- 5 To add/remove channels using the MTS:
 - Touch a Channel Tile Type button (Inputs, Auxes Groups, Matrixes, or Mains) to access those types of channels on the MTS.
 - Touch any Channel Tiles so it is bordered in orange to add them to the Mute Group.
 - Touch a Channel Tile so the orange border disappears to remove that channel from the Mute Group.



Channel Tiles targeted for Mute Group assignment

- 6 To add/remove channels using the channel strips:
 - Bank to the desired channels.
 - Press any channel strip **Attention** switches to add them to the Mute Group. Selected **Attention** switches flash.
 - Press a flashing Attention switch so it no longer flashes to remove it from the Mute Group.
- 7 To confirm the assignments and exit Multi-Assign mode on the MTS tap Multi-Assign so it is unlit.
 - To cancel the assignments and exit Multi-Assign mode, touch the banner display message to expand the message, then select Cancel.

To assign channels to Mute Groups in Channel Control mode:

- See [Assign VCAs and Mute Groups from Channel Control Encoders](#).

Toggling Mute Groups On/Off

You can toggle a Mute Group on/off using the Right Soft Keys on MLM, or using the MTS. Mute Groups 1–6 are available from the first page of the Right Soft Keys menu. Mute Groups 1–24 are available on the Mute Group sub-pages.

Using the MLM

To toggle Mute Groups 1–6 using the MLM:

- 1 In the left-hand column of the Right Soft Keys display, locate any Mute Group 1–6 that you want to activate.
- 2 To turn a Mute Group on, press the corresponding Soft Key so it lights. The channels in that Mute Group are implicitly muted, and their Mute switches (on the control surface) and Mute buttons (on the external screen) flash red.

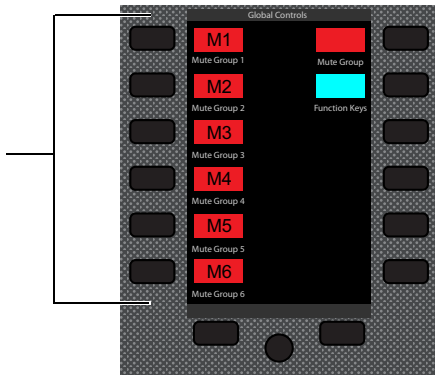

Right Soft Keys and display showing the main menu

- 3 To turn the Mute Group off, press the corresponding Soft Key so it is unlit.

To access all Mute Groups:

- 1 In the right-hand column of the Right Soft Keys display, locate Mute Group and press the corresponding Soft Key. Mute Groups 1–12 are shown in the display.

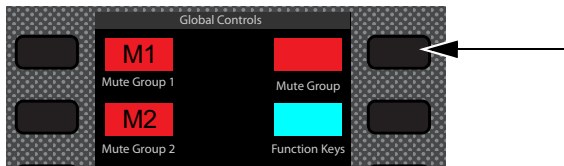

Mute Group Soft Key

- 2 Press any Soft Key to activate the corresponding Mute Group.
 - Or press the lit Next switch to access Mute Group 13–24, then press the corresponding Soft Key.

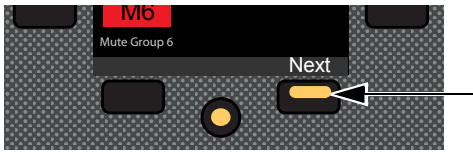

Next Page switch

The channels in that Mute Group are implicitly muted, and their Mute switches flash red.

To return to the first page of the Left Soft Keys menu:

- Press the lit HOME switch.

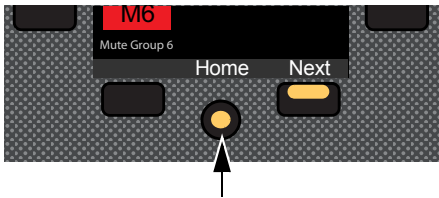

Home switch

Using the MTS

To toggle a Mute Group from the MTS:

- 1 On the MTS, touch Mutes.
- 2 Touch the Mute Channel Tile Function button.



Mute Channel Tile Function button

- 3 To turn a Mute Group on, touch the desired Mute Group Channel Tile so it is bordered in red and the Solo LED is lit red.



An enabled Mute Group Channel Tile

- 4 To turn the Mute Group off, touch the Mute Group Channel Tile so it is no longer bordered in red and LED turns off.

Explicit and Implicit Channel Mute with Mute Groups and VCAs

Any input or output channel implicitly muted by a Mute Group or VCA can be explicitly *un*-muted, explicitly muted, and reset to its implicit mute state by repeatedly pressing a channel Mute switch. Explicitly unmuteing or muting a channel in this way does not permanently remove that channel from the Mute Group or VCA.

This feature is useful to temporarily unmute a channel during a line check without having to release the entire Mute Group or VCA.

To cycle through the available Mute modes:

- 1 Activate a Mute Group, or mute a VCA. The **Mute** switches on all implicitly muted channels flash.
- 2 Press a flashing channel strip **Mute** switch to *explicitly un-mute* the channel. Its Mute switch is now unlit.
- 3 Press the same (now unlit) **Mute** switch again to *explicitly mute* the channel. The **Mute** switch is now lit solid.
- 4 Press the same Mute switch again to implicitly mute the channel and return it to being controlled by the active Mute Group or VCA. Its Mute switch resumes flashing.

 *Select multiple channels first to be able to toggle all their states at once. The Mute behavior may vary if some, but not all, of the selected channels are members of a Mute Group or VCA.*

Snapshot Data and Parameters for Mute

Snapshots can store and recall mute status when the MUTE data type is scoped, as shown in the following table:

Table 2. Snapshot data types and parameters for Matrix mixers

Snapshot Data Type	Included Parameters (for Each Scoped Channel Strip)
MUTE	Explicitly muted channels, and channels implicitly muted via VCA mute.

 *Mute Group state and assignments cannot be stored nor recalled via Snapshots. Mute Group state and information is stored with the Show file.*

For complete information on VENUE snapshots, see [Snapshots](#).

Soloing and the Monitor Buses

The S6L system provides two discrete, independently configurable Monitor buses, as well as two discrete headphone outputs on S6L-32D/24D/24C, each of which is also independently configurable. S6L-16C provides a single headphone output. You can route individual channels to either or both Monitor buses, and feed each Monitor bus to discrete hardware outputs and the headphone outputs.

This chapter shows how to configure the Monitor buses and soloing options on the S6L system, how to adjust the Monitor buses, how to solo channels, and how to use the headphone outputs.

Configuring the Monitor Buses and Solo Options

The S6L system provides two discrete Monitor buses. Each bus is independently configurable. You configure your Monitor buses using the Options > Buses page of the external screen.

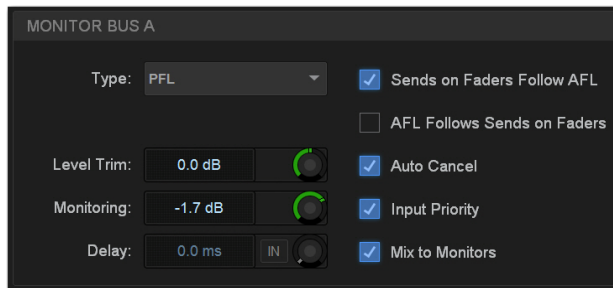

Monitor Bus options on the Options > Buses page

Selecting a Solo Mode

Three Solo modes are offered for input channels: Pre-Fader Listen (PFL), After-Fader Listen (AFL) and Solo In Place (SIP). Outputs are always soloed in AFL mode. You can also toggle Solo modes using the AFL switch in the Monitoring section on the MLM.

To select a Solo mode:

- 1 On the external screen, go to the Options > Buses page.
- 2 Under Solo and Monitor Operation, select the **Type** pop-up menu and choose one the following Solo modes:

Pre-Fader Listen (PFL) PFL Solo mode sends the signal from explicitly soloed input channels to the Monitor bus. The signal is post-insert, pre-fader and pre-mute. Mono input signals are sent to both sides of the Solo bus, and the left and right sides of stereo input signals are sent to the corresponding sides of the Monitor bus. PFL is the default Solo mode.

After-Fader Listen (Stereo AFL) AFL Solo mode sends the signal from explicitly soloed channels and solo-safe inputs to the Monitor bus. Soloing of outputs is always AFL. In AFL Solo mode, both input and output signals are sent to the Monitor bus post-fader and post-pan/balance, and are always panned to stereo even if the Main buses are configured in L-C-R mode.

Solo In Place (SIP) SIP mode applies to input channels only. SIP sends the signal from the soloed channel(s) to the Mains buses, bypassing the Monitor bus. Signal is sent post-pan/balance. Show files do not open in SIP mode. If you save a Show file while in SIP, when you reopen the Show file, it will open in PFL Solo mode.



In SIP mode, the soloed channel(s) is (are) sent directly to the Main buses. Use this feature only at soundcheck.

Sends on Faders Follow AFL

When Sends on Faders Follow AFL is enabled, soloing an Aux output simultaneously assigns its sends to the faders and routes the Aux output's signal to the Monitor bus (in AFL solo mode). Sends on Faders Follow AFL is enabled on each Monitor bus independently. When enabling Sends on Faders, make sure to enable it on the Monitor bus your input channels are currently routed to (assuming you want all input channels to be subject to Sends on Faders).

You can, for example, route some of your input channels to Monitor bus A with Sends on Faders disabled, and route other channels to the other Monitor bus B with Sends on Faders *enabled*. You can then route each Monitor bus to a discrete hardware or headphone output. If any input channels are targeted to *both* Monitor buses, then enabling Sends on Faders on either Monitor bus results in Sends on Faders behavior for that channel.

To enable Sends on Faders:

- 1 On the external screen, go to the Options > Buses page.
- 2 Under Monitor Bus A or Monitor Bus B, select Sends on Faders Follows AFL so it is checked.

AFL Follows Sends on Faders

When AFL Follows Sends on Faders is enabled, entering Sends on Faders mode for an Aux solos that Aux output (requires that the Monitor bus to which the Aux is assigned is configured for Stereo AFL). The AFL Follows Sends on Faders setting is stored and recalled with each Show file. By default, the option is off (not selected).

To set AFL to follow Aux encoder assignment:

- 1 Go to the Options > Buses page.
- 2 In the Solo and Monitor Operations section, select the AFL Follows Sends on Faders option.

Select Follows Solo

See [Select Follows Solo](#).

Auto Cancel and Input Priority

The Auto Cancel option determines whether Solo switches cancel other soloed channels or are additive (latching). The Input Priority option determines whether soloed inputs replace soloed outputs on the AFL/PFL Solo bus.

Auto Cancel On, Input Priority Off A solo cancels all other solos (inputs and outputs)

Auto Cancel On, Input Priority On An input solo cancels all other soloed inputs; an output solo cancels all other output solos; soloed inputs temporarily replace soloed outputs

Auto Cancel Off, Input Priority Off Solos are additive, and soloed inputs and outputs are heard together

Auto Cancel Off, Input Priority On Solos are additive, and soloed inputs temporarily replace soloed outputs.

Sending the Mains Mix to Monitors

This option sends the Mains mix signal to the selected Monitor bus. When enabled (lit), whenever channels are not soloed the Main mix is present in the Headphones output (Phones A or B) that the Monitor bus is routed to (or to near-field monitors when a hardware output is patched to the Monitor bus). This option mirrors the functionality of the **Mix to Monitors** switch.

To send the Main mix to the Monitor bus:

- Press **Mix to Mons** on the MLM on the S6L control surface.
 - or –
- Go to the Options > Buses page and select the Mix to Monitors option.

Monitor Output from an L-C-R Main Mix

The stereo Mix to Monitors signal is derived from the L-C-R Main mix by adding a -3 dB signal from the Center channel to the Left and Right monitor channels.

Monitor Output from an L-R+M Main Mix

In a L-R+M Main mix, only the Left and Right channels are heard in the Monitor bus.

Listen to Monitors

This feature is not yet implemented.

Adjusting Monitor Buses

You can route and adjust Monitor bus levels using the S6L control surface or the external screen. You can apply a delay to each Monitor bus on the external screen.

Routing Channels to the Monitor Buses

You can route any channel to either or both Monitor buses independently. You can route channels to Monitor buses using the channel strip Channel Menu and the external screen. By default, all channels are routed to Monitor Bus A. When you solo a channel, the soloed signal is sent to the Monitor bus.

⚠ *When a channel is routed to both Monitor buses, any solo and monitoring options set on either bus affect the behavior of that channel when soloed.*

To route channels to the Monitor buses using the Channel Menu:

- 1 Bank the desired channels to the control surface's faders.
- 2 Press the channel strip **Menu** switch until Monitor appears in the channel display.
- 3 To route the channel to Monitor Bus B, press the Left Menu switch so it is unlit. The Right Menu switch lights. Mon B appears in the channel display, and on the CTM and MTS in Channel view.
- 4 To route the channel back to Monitor Bus A, press the Right Menu switch so it is unlit. The Left Menu switch lights. Mon A appears in the channel display, and on the CTM and MTS in Channel view.
- 5 To route channels to both Monitor buses, press the Left and Right Menu switches so they are both lit. Mon A+B appears in the channel display, and on the CTM and MTS in Channel view.



A channel display showing a channel routed to Monitor Bus A (Left) Bus B (center) and Buses A and B (right)

To route channels to the Monitor Buses on the external screen:

- 1 Navigate to the desired channel on the Inputs or Outputs page of the external screen.
- 2 Select the Mons A/B/A+B button to cycle through the three Monitor Bus routing options for the attentioned channel.

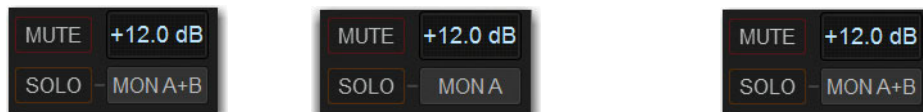

External screen showing a channel routed to Monitor Bus A (Left) Bus B (center) and Buses A and B (right)

Adjusting Monitor Bus Level

The Monitoring encoder on the MLM lets you target a Monitor bus for level control of the targeted Monitor bus.

To adjust the level of a Monitor bus on the control surface:

- 1 Push the encoder to target the encoder to Monitor bus A or B. The A or B LED lights to indicate the currently targeted Monitor bus.
- 2 Rotate the encoder to adjust the level for the targeted Monitor bus. Monitor bus levels are indicated on the Monitor Bar at the bottom of the MTS.

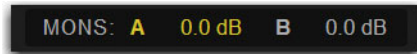

Monitor Bar

To adjust the level for the Monitor bus on the external screen:

- 1 Go to Options > Buses.
- 2 In the Solo and Monitor Operations section, adjust the Monitoring encoder.

Delaying a Monitor Bus

You can delay a Monitor bus to time-align it with the sound coming from the stage.

To adjust monitor bus delay:

- 1 On the external screen, go to Options > Buses.
- 2 Select the In button beneath the on-screen encoder to enable Delay for the desired Monitor bus.
- 3 Select the Delay encoder in the section and drag to adjust. When lit, the Delay setting is applied to the monitor output.

Routing the Monitor Bus to Outputs and Plug-Ins

The Monitor bus can be routed to hardware outputs and to bus-fed plug-ins.

Hardware Outputs For routing to hardware outputs, the Monitor (Solo) bus outputs are available in the Mains tab of the Patchbay > Outputs page. Monitor bus outputs are assignable to any number of physical outputs on the system. Use this capability to route monitor outputs to multiple cue stations (in-ear mix and wedge mix), to an outboard analyzer, to a listen wedge mix, or to near-field monitors. Monitor busses can also be assigned as Matrix input sources.

Bus-Fed Plug-Ins For routing to bus-fed plug-ins, the Monitor bus appears as a choice in the plug-in routing selector. This lets you route the Monitor bus to a bus-fed stereo plug-in such as an onboard analyzer. Plug-ins can not be inserted on the Monitor bus.

Routing the Monitor Bus to Hardware Outputs

To route the Monitor bus to hardware outputs:

- 1 In the Patchbay, select the Outputs tab, then select the Mains tab.
- 2 Select a Hardware I/O tab to select the desired hardware output.
- 3 Select in the grid to assign the desired Monitor bus to the desired destination.



Solo In Place, when engaged, is simultaneously routed to the Main and Monitor buses.

Routing the Monitor Bus to Plug-Ins

To route Monitor output to a bus-fed plug-in:

- 1 On the external screen, go to the Plug-Ins page.
- 2 Make sure the desired stereo plug-in is installed and assigned to a rack slot.
- 3 Select the Plug-In Input selector at the top of the corresponding rack slot, and choose Bus Outs > Mains > Monitor - stereo.

Soloing Channels

Solo operation depends on the type of channel being soloed, and on any selected solo options. In all modes, a channel's **Solo** switch lights to indicate that the channel is soloed.

Input Channels Soloing an Input Channel sends signal to the Solo bus (when in PFL or AFL modes) or to the Mains bus (when in SIP mode). In SIP mode only, when a channel is soloed, all other channels that are not soloed or solo safe are implicitly muted. Implicit mutes are indicated by a flashing mute switch.

Output Buses Soloing an output channel sends signal to the AFL/PFL Solo bus. This applies to Groups, Auxes, and Matrixes. Outputs are always AFL. Stereo buses use true stereo AFL. When you solo a stereo bus, the two buses are heard as a stereo pair when soloed. Mono buses are heard as dual mono when soloed.

Momentary And Latching Switch Operation

Channel strip **Solo** switches can operate with either momentary or latching behavior.

To engage momentary solo on a channel:

- Hold the **Solo** switch for more than one second. Release the solo switch to un-solo the channel.

To latch solo on a channel:

- Press and release the **Solo** switch. Press the switch a second time to unsolo the channel.

Soloing Single Channels

You can solo channels from the channel strip, the MTS, and the external screen.

To solo a single channel from the channel strip:

- Press a channel strip **Solo** switch so it lights. The solo switch latches on a momentary press.
– or –
- Hold the channel **Solo** switch for more than one second for momentary solo. The channel will automatically unsolo when you release the switch.

To toggle solo from the MTS:

- 1 Touch **Universe** to show the Universe view.
- 2 Touch the appropriate Channel Type button (**Inputs**, **Auxes**, **Groups**, **Matrixes**, **VCAs**, or **Mains**) to show the channel you want to solo.
- 3 Touch the **SOLO** Channel Tile Function button so it lights.

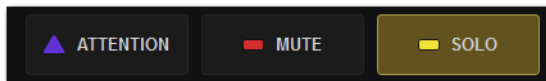

Solo Channel Tile Function button

- 4 Touch the a Channel Tile. The Channel Tile is bordered in yellow and the Channel Tile Mute LED lights solid yellow to indicate the channel is muted.



A Channel Tile showing a soloed Aux output

To toggle solo on a single channel from an external screen fader strips:

- 1 Select the Overview, Inputs, or Outputs page:
- 2 Select the Solo button on the desired channels' fader strip so it is lit.
 - or –
 - From the Inputs or Outputs page

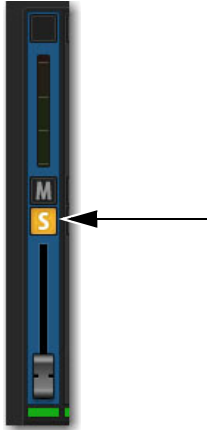

Fader strip Solo button enabled

Soloing Multiple Channels

You can solo multiple channels using channel strip **Solo** switches.

To solo multiple channels:

- 1 Bank the desired channels to the faders.
- 2 Do one of the following:
 - With the Auto Cancel option enabled, press the **Solo** switches on multiple channel strips simultaneously.
 - or –
 - Hold **Multi-Select** and press the **Solo** switches on one or more channel strips.
 - or –
 - With the Auto Cancel option disabled, press **Solo** switches on multiple channels in any sequence. The **Solo** switches latch on.

Toggling the Solo Status of Multiple Channels

To toggle the Solo status of multiple channels, do one of the following:

- With the Auto Cancel option enabled, hold the **Multi Select** switch while pressing the Solo switches on channels you want to toggle.
- With the Auto Cancel option disabled, press Solo switches in any sequence. The Solo switches latch on and off.

Soloing VCAs

When you solo a VCA, its member channels are soloed. If the VCA members include a combination of input and output channels, their solo status follows any selected solo options.

Clearing Solos

To clear all soloed channels:

- Press the flashing **Solo Clear** switch to clear all soloed channels.



The Events list can be used to assign the Solo Clear function to a footswitch or any other available trigger.

Solo Bus Metering

When a channel or dynamics key input is sent to the Solo bus, its signal is metered on the Selected Channel meters, temporarily replacing the metering for any currently targeted channel.

Trimming Solo Bus Level

PFL Solo bus monitoring levels can be controlled by the on-screen Level Trim control in the Solo and Monitor Operations section. The trim amount is adjustable over a range of -20 dB to $+20$ dB.

PFL signals are frequently hotter than AFL signals. Because Level Trim only affects PFL signals, you can use Level Trim to balance PFL volume levels with AFL or Mix to Monitors volume levels, with a minimum of Monitoring level adjustment during a show.

To trim the Solo bus level:

- 1 Solo a channel.
- 2 Go to Options > Buses, and adjust the Level Trim setting in the Solo and Monitor Operations section.

The following diagrams show the signal flow for PFL and AFL modes.

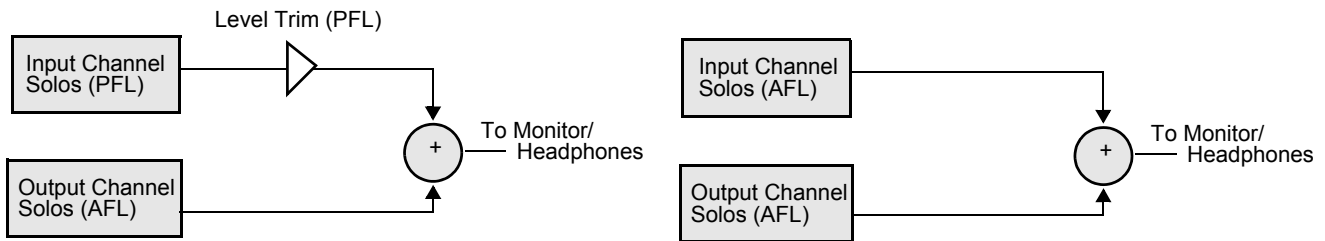

Level Trim in PFL mode (left) and no Level Trim in AFL mode (right)

Solo Safing Channels

Solo Safing an input channel prevents that channel from being implicitly muted when any other channel is soloed. Solo safed channels are automatically added to any explicitly soloed channels. Solo Safe only applies to SIP and AFL solo modes. Solo safe status is ignored in PFL mode.

You can Solo Safe channels using the Channel Safe switches and on the external screen fader strips. You can also Solo Safe a channel using the CKM in Channel Control mode. Solo Safe mode is enabled on the Options > Interactions page.

To enable Solo Safe for the Channel Safe switches:

- 1 On the external screen, go to the Options > Interaction page.
- 2 In the Channel Safe Switches section, under Inputs and Outputs, select Solo Safes as desired.

 You can create an event that lets you cycle through the various Channel Safe switch modes, as well as suspend or disable Bank Safe (Disable Bank Switch). See [Creating Events](#).

To Solo Safe channels using the Channel Safe switches:

- 1 Make sure you have enabled Bank Safe for the Channel Safe switches.
- 2 On the S6L control surface, do the following:
 - Bank the desired channel to the faders.
 - Press **Safe** for the channel you want Solo Safe.



S6L Channel Safe switch engaged

3 On the external screen, do the following:

- Go to the Inputs or Outputs page, and navigate to the desired channel using the provided tabs and buttons.
- Select the Channel Safe switch for the desired channel, located at the top of each fader strip.

Solo Safe a channel using the CKM:

1 Bank the desired channel to the faders.

2 Select the to Automation Safe so it lights, and then press the **INPUT** Channel Control Function switch so it lights.

– or –

- Touch the channel’s Input touch zone on the associated Channel Touch Module (CTM).

3 Locate the Solo Safe encoder, indicated by Solo Sf on the encoder display, and press the encoder.

The encoder **In** switch lights green, and the channel is Solo Safed.



Automation Safe parameter on a CKM encoder

Solo Safe status for the channel is indicated as follows:

- On the control surface channel strip, the **S** LED lights yellow.
- In the Input section of the MTS and CTM Channel view for the channel, **S** lights yellow.
- On the external screen the Safe button flashes green and shows the letter S (A appears if the switch is acting as an Automation Safe, and B appears if it is acting as a Bank Safe).

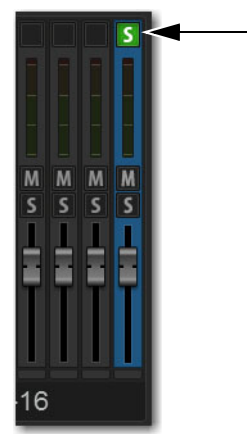
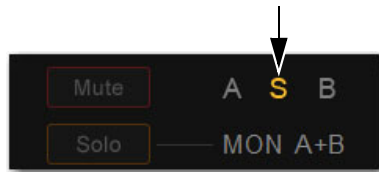
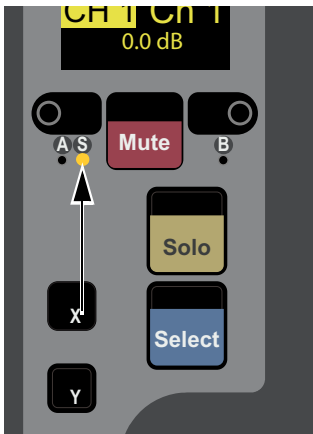

Indications that a channel is Solo Safed on the channel strip (left) the MTS/CTM Channel view (center) and on the external screen (right)

Using the Headphone Outputs

The front panel of the S6L-32D/24D/24C control surface provides two discrete headphone outputs (Phones A and B). S6L-16C provide a single headphone output (Phones).

Configuring the Headphones Outputs

You can choose the Monitor bus that you want feeding each headphone output.

To configure the headphone output:

- 1 On the external screen, go to the Options > Busses page.
- 2 In the Headphones section, located the Phones A and Phones B pop-up menus. With S6L-32D/24D/24C, Phones A corresponds to the left front-panel headphone jack, and Phones B corresponds to the right headphone jack.
- 3 Select a Phones pop-up menu, and choose one of the following:
 - To feed Monitor Bus A to the headphone output, choose Mons A.
 - To feed Monitor Bus B to the headphone output, choose Mons B.

Adjusting Headphone Level

Output level for each headphone output is controlled by its corresponding volume control located next to each headphone jack. The overall level of the Monitor bus feeding the headphone output also contributes to the headphone level.

To adjust Headphone level:

- Adjust the headphone volume control to adjust level as needed.

 *The headphone volume control is post-Monitor bus level. If no signal is present on headphones, make sure the level for the Monitor bus is set properly.*

Part III: External VENUE Software Screen

External VENUE Software Screen Overview

You do not need the external VENUE software screen to mix a performance, as all essential mixing controls are provided on the S6L control surface. However, the external screen is essential when setting up and configuring the system before a performance.

Viewing Pages and Tabs

To access pages and sub-tabs on the external screen, use the buttons at the top of the external screen, **F** switches and Soft Keys on the MLM, or the computer keyboard.

Using the External Screen

To view a page, do one of the following:

- Select a Page button at the top of the screen so it lights orange.

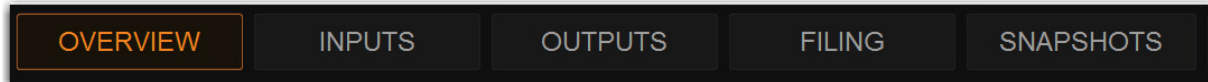

Overview page button selected

To view a tab:

- On the Overview, Filing, Snapshots, Patchbay, Control and Options pages, select a tab below the page names.

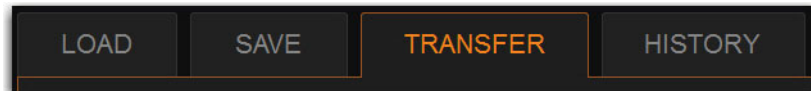

Transfer tab of the Filing page selected

- On the Inputs and Outputs pages, select the tabs along the side of the fader section to access those types of channels.

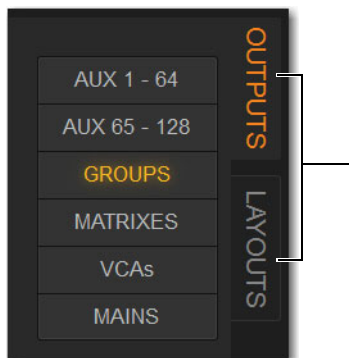

Outputs tab selected on the Outputs page

- For output channels, select a tab below the page name to access processing functions for the currently attentioned channel.

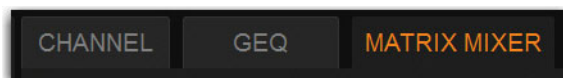

Matrix Mixer tab of a Matrix output selected

Using Switches on the MLM

The MLM provides **F 1–5** switches in the Transport/Function switch section.

Transport/Function Switches

These dual-function switches provide dedicated switches to control the Pro Tools Transport, as well as programmable function switches that you can use to control a wide range of system parameters using events.

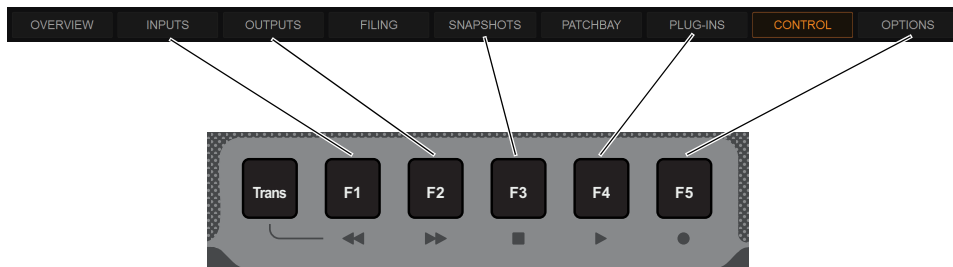

F1–5 switches

When **Trans** is unlit, by default the switches target pages on the external screen, as follows:

- F1** Targets the Inputs page.
- F2** Targets the Outputs page.
- F3** Targets the Snapshots page.
- F4** Targets the Plug-Ins page.
- F5** Targets the Options page.

 To see the default (factory) Function key assignments, use the **Clear Console** command. All available Function Keys can be assigned and reassigned using **Events**.

To view a tab:

- While viewing the Overview, Filing, Snapshots, Patchbay, Control or Options pages, press its corresponding **F** switch (1–5) repeatedly to cycle through available tabs.

Soft Keys

Function view on the MLM Soft Keys provide all default View mode events, letting you access Control, Overview, Filing, and Patchbay pages and their tabs, in addition to Inputs, Outputs, Snapshots, Plug-ins, and Options.

To access Function view on the MLM:

- 1 Press the Function key in the right bank of MLM Soft Keys.
In Views with multiple tabs (such as Options) press its Soft Key repeatedly to cycle through its tabs.
- 2 To navigate to Functions 13–24, press the Soft Key below Next.

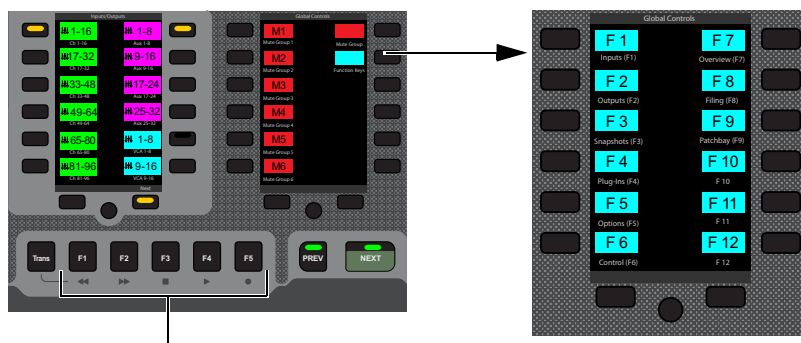

Function switches (F1–F5), and Function Soft Keys

To access all Function Keys:

- 1 In the right Soft Keys on the MLM, press the switch for Function Keys.
The first 12 currently assigned Function switches appear in the Soft Keys.

To view a tab:

- While viewing the Overview, Filing, Snapshots, Patchbay, Control or Options pages, press its corresponding **F** Soft Key repeatedly to cycle through available tabs.

By default, Function Soft Keys 1–9 target pages on the external screen (see [Default F Key assignments and Keyboard Equivalents](#)). Target pages are shown in the Soft Key (Event) name.

Using the Computer Keyboard

You can also use the F keys on your computer keyboard to target pages on the external screen. Keyboard F keys map to VENUE pages left-to-right. For example, keyboard F1 targets the Overview page, F2 Inputs, and so on.

The following table lists both the VENUE F key assignments and computer keyboard assignments.

Table 3. Default F Key assignments and Keyboard Equivalents

VENUE View	VENUE F keys (default Event keys)	Keyboard F keys
Inputs	F1	F2
Outputs	F2	F3
Snapshots	F3	F5
Plug-Ins	F4	F7
Options	F5	F9
Control	F6	F8
Overview	F7	F1
Filing	F8	F4
Patchbay	F9	F6

Overview of Software Pages

The software screen provides the following pages and tabs.

Overview

View meters, attention, mute, and solo channels.



Overview page

Inputs and Outputs Pages

Attention channels, and view, name, configure, and adjust parameters for the currently attentioned channel.



Inputs page

See [Overview, Inputs, and Outputs Pages](#).

Filing

Load, save, and transfer shows and presets, and access the console History.

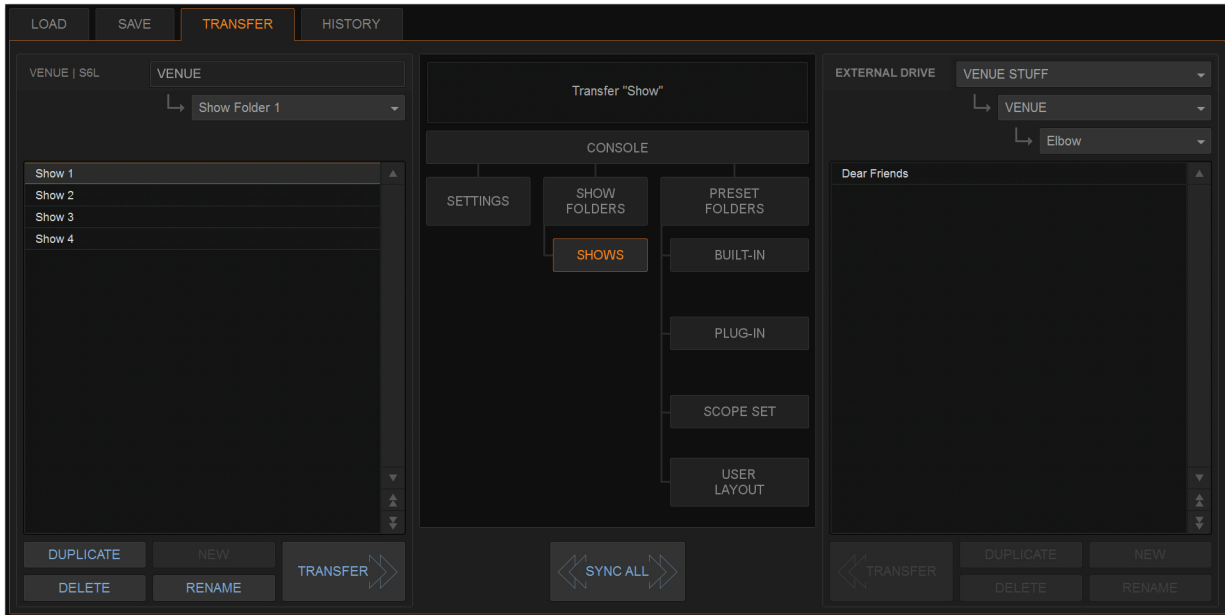

Filing page (Transfer tab)

 See [Filing](#).

Snapshots

Store and recall snapshots, and access the Recall Safe window.

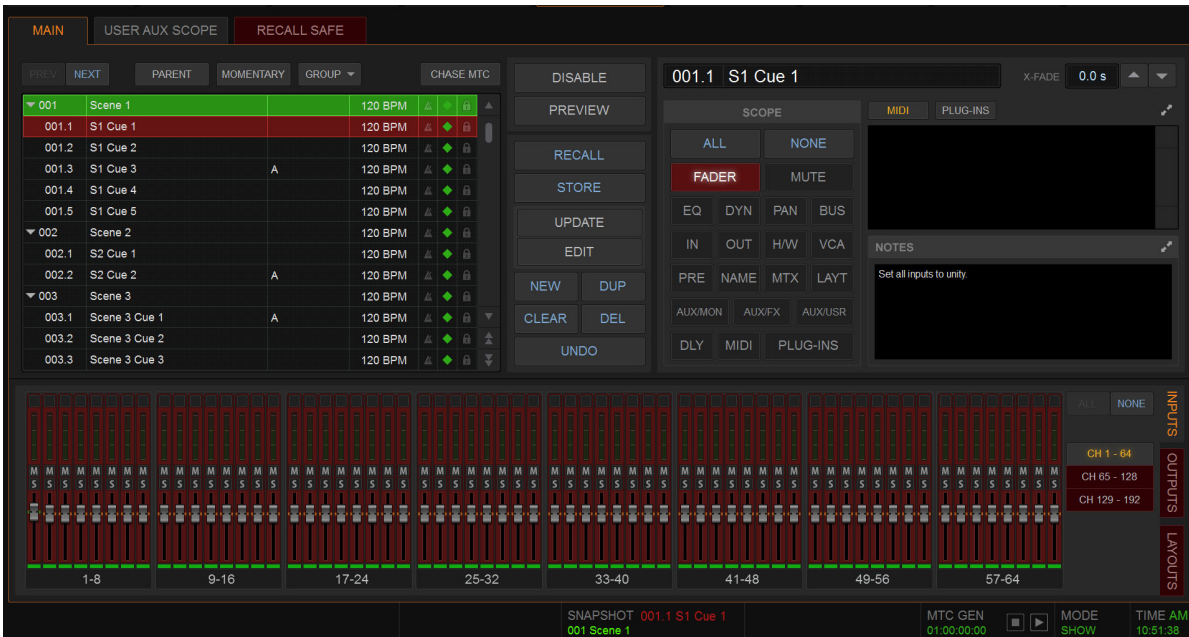

Snapshots page

 See [Snapshots](#).

Patchbay

Patch input and output channels to hardware inputs and outputs, and name channels.

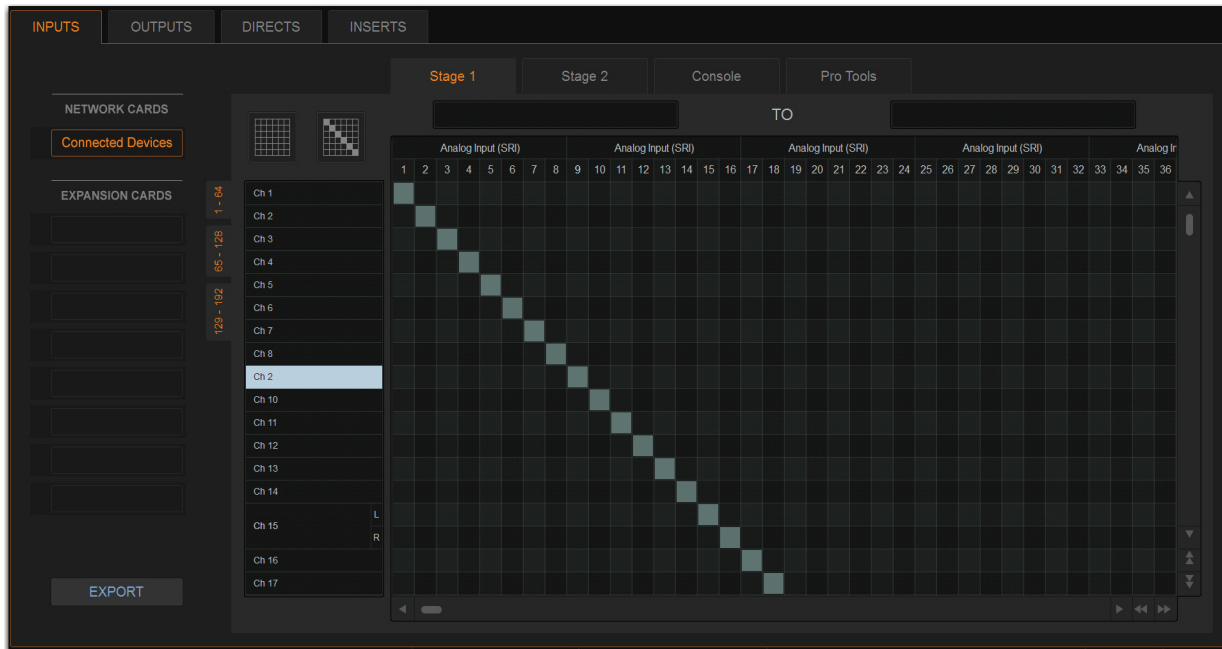

Patchbay page

 See [Patchbay](#).

Plug-Ins

Configure and arrange plug-in racks, and assign, patch/route, and manage plug-ins.

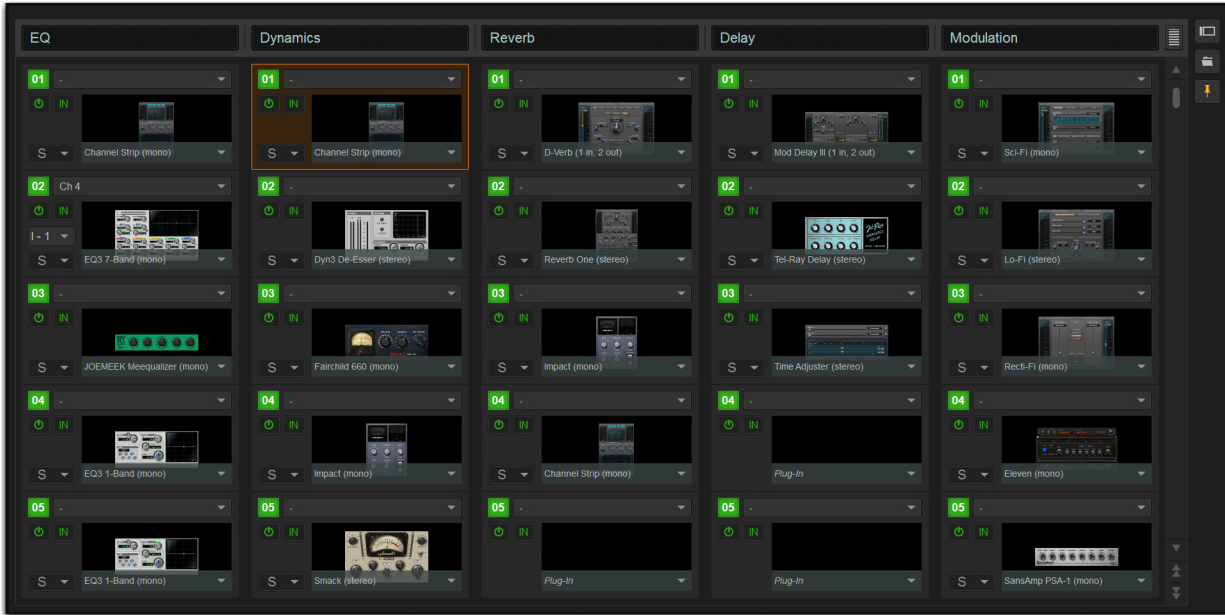

Plug-Ins page

 See [Plug-Ins](#).

Control

Manage Mute Groups and configure events.

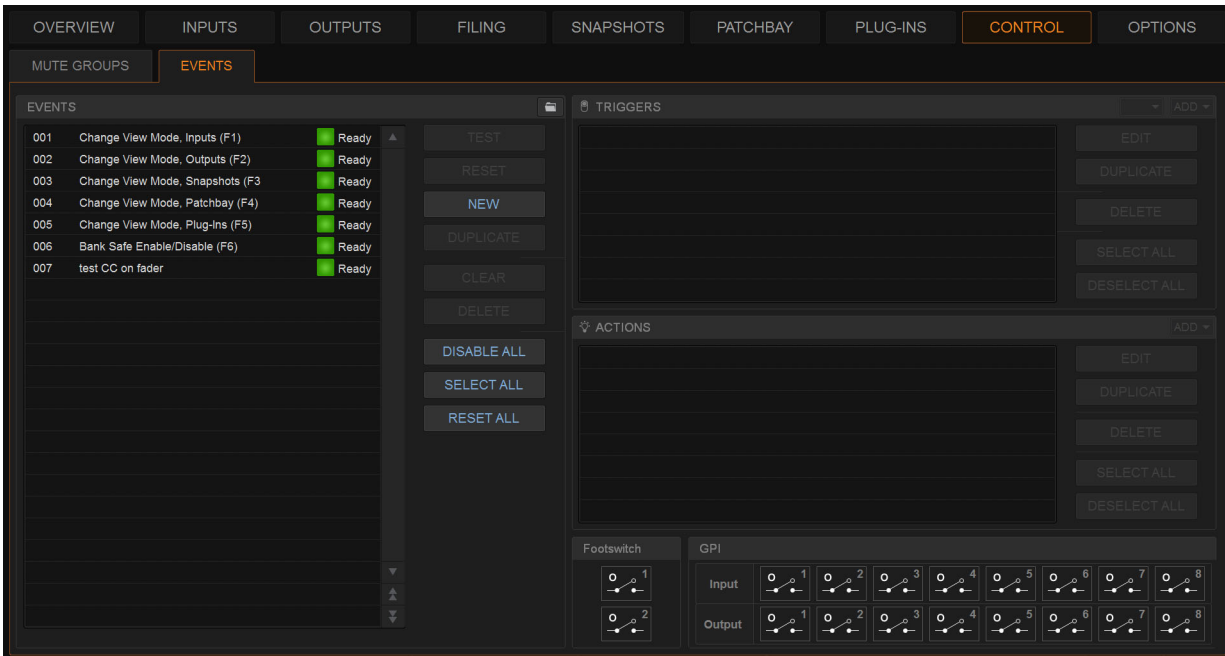

Control page Events tab

 See [Events](#). For Mute Groups, see [Muting and Mute Groups](#).

Options

Configure system, routing and metering options, set interaction, hardware and general preferences, and install plug-ins.

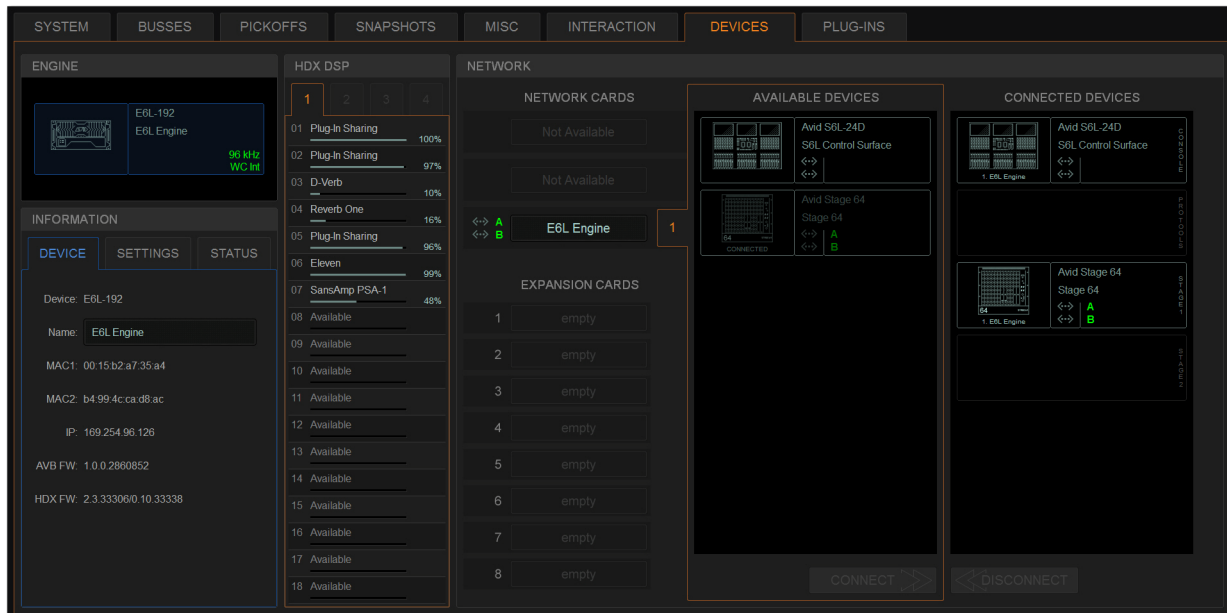

Options page (Devices tab shown)

 See [Options](#).

Banner Display

At the bottom of the external screen, a banner display shows message and alert dialogs, and system status information at all times.

Messages, alerts, and warning dialogs in the banner display alert you to certain operating conditions such as Multi-Select and Multi-Assign modes (appearing in blue), system alerts (appearing in orange) and warning dialogs (appearing in red). You can select the messages and alerts shown in the banner display to expand the message, letting you confirm (OK) or cancel the current mode, and dismiss alerts and warning dialogs.



Banner display showing a message

When adjusting a parameter, the banner display shows the value of the parameter (such as fader level or EQ band gain) as you make changes to that parameter.

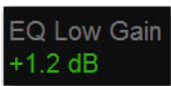

Banner display showing the value of the currently adjusted parameter

The banner display also shows snapshot information, the current operating mode (Show or Config mode), and system status information such as a plug-in rack status and word clock status. You can choose to show the current time in the Status area (see [System Clock](#) for more information).



Banner display showing snapshot information, current operating mode, and status

Type Text Search

Type Text search lets you use the keyboard for fast navigation to a channel, or to quickly go to a specific snapshot or event. You can enter the first characters of a channel name or the absolute channel number to target that channel on the external screen, or in Channel Control (see also [Selecting Channels](#).)

To search for and select a channel by name:

- 1 Go to the Inputs, Outputs, or Patchbay page.
- 2 Type the first few letters, channel number, or full name of the channel. For example, type “s” to go to the first channel beginning with the letter s (such as Snare).
- 3 Press the Tab key on your keyboard to cycle through and select any other channels beginning with that letter (such as *Snare Top*, *Snare Bottom*, or *Strings*).

To search for and select a list item by name (or number):

- 1 Go to the Snapshots page, Filing page, or the Events tab of the Options page. Or, select a Presets window (built-in Dynamics or EQ presets, Input Channel presets, or Scope Sets).
- 2 Type the first few letters or number of the desired item.
- 3 Press the Tab key on your keyboard to cycle through and select any other items that begin with the same letters.

Channel Numbers and Names

Channel numbers in VENUE are “absolute” channel numbers. Renaming changes the displayed name associated with each channel, but the absolute channel number remains fixed.

To search for and select a channel by absolute number:

- Type a number on the keyboard to select the corresponding channel.

Overview, Inputs, and Outputs Pages

The Overview, Inputs, and Outputs pages of the external VENUE software screen show channel data for system input and output processing channels, and let you adjust certain channel parameters, as follows:

Overview Provides output meters for all system input or output channels, and lets you attention, solo, and mute channels. If using an S6L-16C, the Universe view is a tab available in the Overview page. (On other control surfaces, Universe view is displayed on the MTS.)

Inputs and Outputs Show channel data for the currently attentioned channel, including virtual fader strips for up to 64 channels at a time, and let you adjust many different channel parameters for the currently attentioned channel. The Inputs and Outputs pages also let you perform tasks such as reordering input channels using drag-and-drop, copying and pasting channel settings, inserting blank channel strips, and managing members of output channels.

Navigating the Overview, Inputs, Outputs Pages

To access the Overview, Inputs, or Outputs page, use the buttons at the top of the external screen, buttons on the MLM, or the keyboard.

To access the Overview page:

- Select the Overview button, or press the **F1** key on the keyboard.

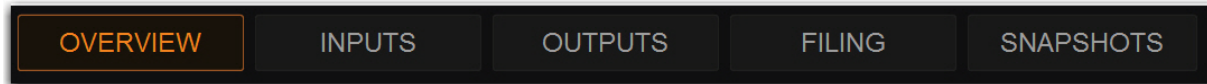

Overview page button selected

To access the Inputs page:

- 1 Select the Inputs button.
- 2 Press the **F1** Function switch on the MLM.
 - or –
 - Press the **F2** key on the keyboard.

To access the Outputs page:

- 1 Select the Outputs button.
- 2 Press the **F2** Function switch on the MLM.
 - or –
 - Press the **F3** key on the keyboard.

Universe View

If using an S6L-16C, the Universe view is a tab available in the Overview page. On other control surfaces, Universe view is displayed on the MTS.

To access channels on the Inputs or Outputs page:

- 1 Go to the Inputs or Outputs page.
- 2 Select the Inputs or Outputs tab along the side of the fader strip section.
- 3 Do either of the following depending on the tab you selected:
 - For inputs, select the button showing the channel range you want to access (CH 1–64, CH 65–128, or CH 129–192).
 - For outputs, select the button showing the type of output channels you want to access (Aux x–xx, GROUPS, MATRIXES, VCAs, or MAINS).

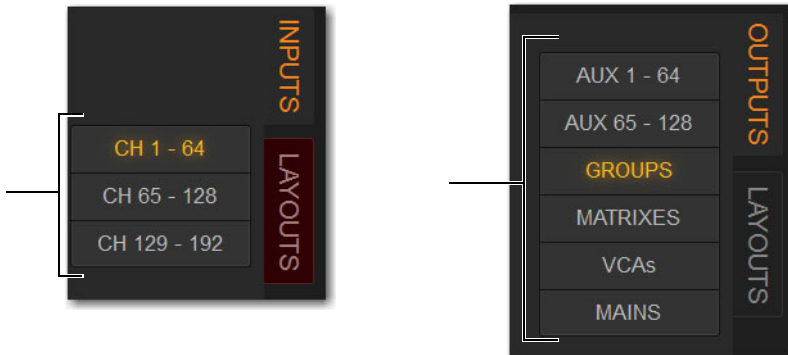

Input Channel Bank buttons (left) and Output Channel Type buttons (right)

To access channels on the Overview page:

- 1 Go to the Overview page.
- 2 Select the Inputs or Outputs tab, under the Overview button, to access those respective channels on the Overview page. Solo and mute are activated by clicking on the corresponding icon.

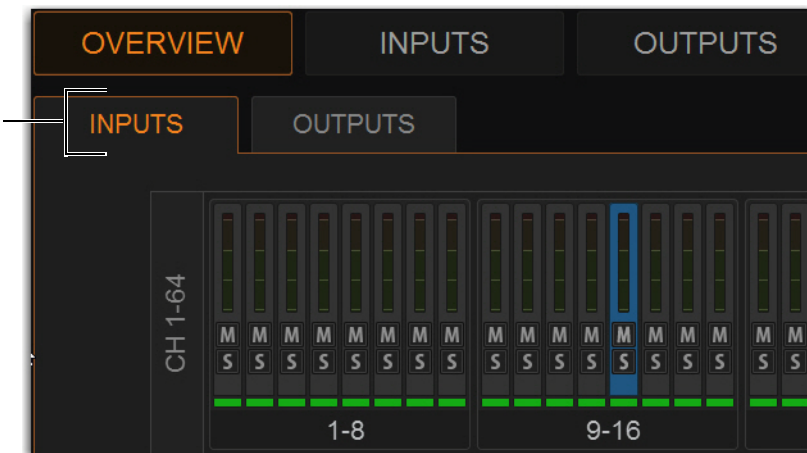

Overview page Inputs and Outputs tabs (Inputs selected)

Attentioning Channels from the External Screen

You can attention channels from the Overview, Inputs, or Outputs page. When you attention channels from the external screen, the channels are also attentioned on the channel strips and on the MTS (and vice-versa). By default, the Inputs or Outputs page shows the attentioned channel's parameters, which you can adjust on the external screen.

To attention a channel on-screen

- Touch anywhere in the on-screen fader strip, except on the fader, mute, solo or safe buttons.

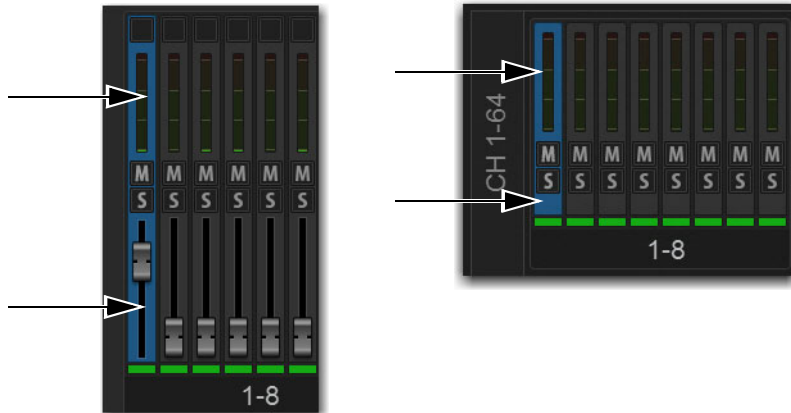

Touch in the indicated areas to attention a channel from the external screen fader strips (Inputs/Outputs page at left, Overview page at right)

To attention multiple channels on-screen:

- Press and hold the **Multi-Select** switch (or hold Shift on the keyboard) and touch the fader strips on-screen.

To select an 8-channel bank on-screen:

- Touch the bank name (such as 1–8 or Aux 1–8) below the on-screen fader strips to select all the channels in that bank. Hold Shift and touch to select additional banks or channels. One channel remains the attentioned channel, and lights blue.

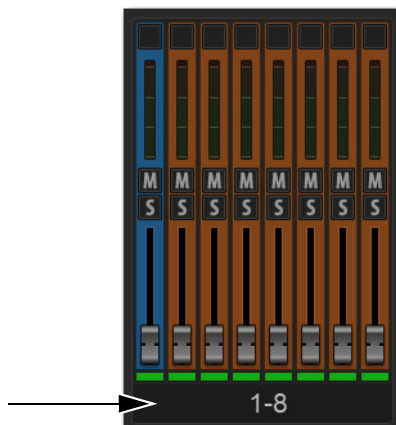

Select the bank display to select multiple channels on-screen

To select all input channels or all output channels on-screen (Multi-Select):

- Double-tap any bank name below the on-screen fader strips in the Input or Outputs screen. One channel remains the attentioned channel, and lights blue.

To remove a channel from a selection:

- Control-touch (or **Fine**-touch) a highlighted channel.

To exit a Multi-Selection:

- Press the **Cancel** switch on the MLM, or the Cancel button in the on-screen banner display.

Adjusting Parameters on the External Screen

This section describes how to adjust channel parameters on the external screen. Control over the parameters described here are common to input and output channels.

Adjusting Faders on the External Screen

You can move on-screen faders independently or in ganged fashion.

To adjust a single fader on-screen, do one of the following:

- Touch, hold, and drag the fader of one of the attentioned channels.



Drag a fader on-screen to adjust channel level

To move multiple faders on-screen in ganged fashion:

- 1 Attention multiple channels on-screen.
- 2 Touch, hold, and drag the fader of one of the attentioned channels.

The faders on the selected channels will move in ganged fashion. Any offset between the faders is maintained until at least one of the faders is minimized (moved to $-\infty$) or maximized (set to +12 dB).

To reset an entire channel to its default settings:

- On-screen, touch and hold (right-click) the on-screen fader and choose Reset Ch <n>.

Adjusting Encoders on the External Screen

You can adjust on-screen encoders by dragging the encoder.

To adjust an on-screen encoder:

- 1 Touch an encoder so that it is highlighted.
- 2 Drag upwards to turn the encoder clockwise; drag downwards to turn the encoder counter-clockwise.

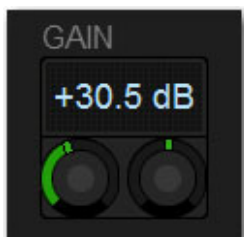

On screen encoders

Adjusting Values on the External Screen

In addition to typing numeric values in text boxes, you can adjust parameter values and numeric option settings on-screen by dragging directly over the corresponding text box, and by entering values using the keyboard.

To adjust a value on-screen by dragging:

- 1 Select the text box to highlight the value.
- 2 Drag up to increase the value; drag down to decrease the value.
 - or –
 - Type in a value using the keyboard, and press Enter.



Entering a parameter value on the external screen

Toggling Buttons on the External Screen

You can toggle on-screen buttons such as Solo and Mute by touching (selecting) the on-screen button.

To toggle an on-screen button:

- Touch the button to toggle that parameter on/off. The button lights when the parameter is on.

Resetting Channels and Parameters from the External Screen

You can reset a single parameter, and reset an entire strip (including its I/O hardware patching) to default settings from the external screen.

To reset an on-screen parameter to its default value, do one of the following:

- Touch-and-hold (right-click) the control and choose Reset <parameter> to <default value>.

To reset all parameters on a channel:

- 1 Enable Config mode.
- 2 Go to the Inputs or Outputs page.
- 3 Touch-and-hold (right-click) the fader strip and choose Reset <channel name/number>.

Working with EQ and Dynamics on the External Screen

You can adjust built in channel EQ, Graphic EQs (GEQs), and Dynamics on the Inputs and Outputs pages for the attentioned channel. You can also insert GEQs on the Outputs page. Input Direct, for input channels only, lets you bypass all EQ and Dynamics.

Adjusting Channel EQ on the External Screen

You can toggle EQ on/off, adjust frequency and gain for any available EQ band of the built-in EQ, toggle Analog and Digital EQ modes, and engage Input Direct.

To toggle EQ on/off:

- 1 Go to the Inputs or Outputs page and attention the desired channel.
- 2 Select the EQ in/out button. The EQ is in when the button lights.

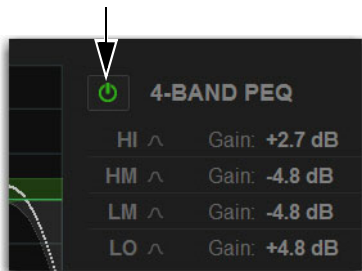

EQ in/out button

To adjust EQ on the screen using the Graph display:

- 1 Go to the Inputs or Outputs page and attention the desired channel.
- 2 Select the EQ in/out button to put the EQ in circuit.
- 3 Drag the handles in the on-screen EQ graph display for each EQ band (Lo, Lo-Mid, Hi-Mid, or Hi), as follows:
 - Drag a handle right or left to adjust EQ band frequency.
 - Drag a handle up or down to adjust EQ band gain.

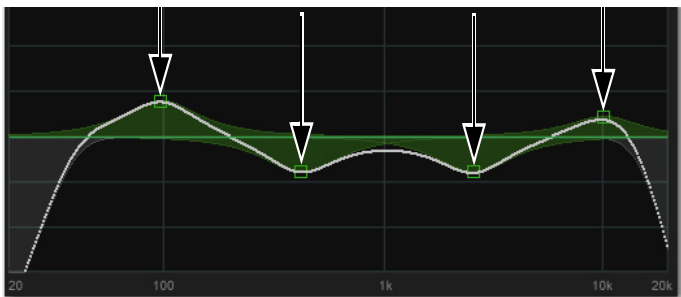

Drag the handles in the EQ graph display to adjust EQ

Analog and Digital EQ Modes

The Analog button on the Inputs and Outputs pages of the external screen toggles the built-in EQ between digital mode and analog mode, on a per-channel basis, and is adjusted on-screen.

Digital Mode Provides a standard digital parametric EQ. Frequency range of 20 Hz to 20 kHz and gain range of +/-18 dB are available on all bands. Hi and Lo bands can be Bell (default) or Shelf. Digital Q is expressed in Q factor terms in the range 10 (left, a narrow band) to 0.1 (right, a wide band). Digital mode is the default EQ mode.

Analog Mode Provides an EQ with a response modeled on that of an analog console renowned for its EQ section. Frequency range is limited to match, and the outer bands provide shelving only. Analog Q is expressed in octaves of *bandwidth* in the range 0.1 (left, a tenth of an octave) to 2 (right, two octaves.)



The HPF and LPF does not change when the EQ is switched between Digital and Analog mode.

To toggle analog and digital EQ modes:

- Select the Analog button. Analog lights when the EQ is in analog mode, and is unlit when in digital mode.

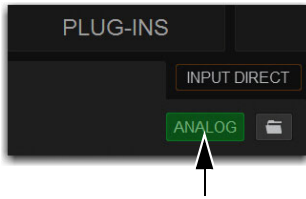

Analog/Digital EQ button (Analog enabled)

Adjusting Graphic EQ on the External Screen

S6L systems provide 32 built-in 31-band Graphic EQs (GEQs), which you can insert on the Mains, Group, Aux, and Matrix outputs. You can adjust GEQs on the external screen, as well as using the CKM (see [Adjusting Graphic EQ on the Control Surface](#)).

To insert a Graphic EQ on an Output bus:

- 1 Go to the Outputs page and attention the output channel in which you want to insert the Graphic EQ.
- 2 Select the GEQ tab.
- 3 Select the Graphic EQ selector and choose an available mono or stereo Graphic EQ.

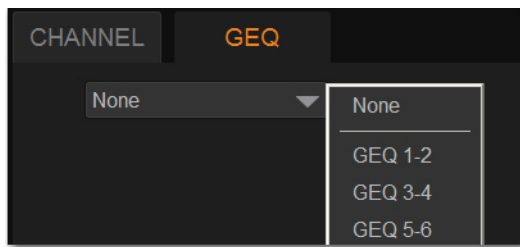

Selecting a Graphic EQ

The entire Graphic EQ is displayed on-screen.

To toggle the GEQ in/out:

- Select the GEQ in/out button. GEQ is in when the button lights.

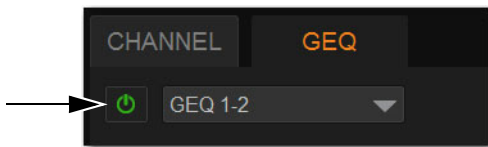

GEQ in/out button

To adjust GEQ on the external screen:

- Drag the GEQ band sliders up or down to adjust band gain.

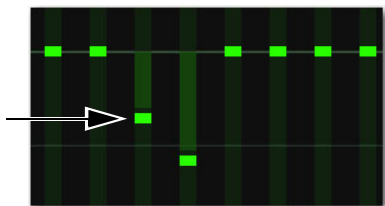

GEQ sliders

To adjust GEQ overall output level:

- Drag the GEQ output level encoder, or select the level field and type in a value.

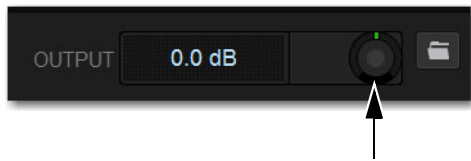

GEQ output level

Adjusting Dynamics on the External Screen

To toggle Dynamics on/off:

- 1 Go to the Inputs or Outputs page and attention the desired channel.
- 2 Select the Exp/Gate and/or Comp/Lim in/out buttons, as desired. The processor is in when the button lights.

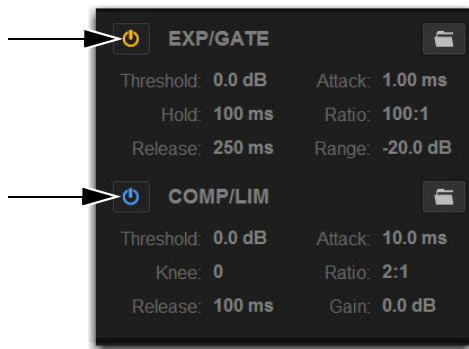

Dynamics In/Out buttons

To adjust Dynamics on the screen using the Graph display:

- 1 Go to the Inputs or Outputs page and attention the desired channel.
- 2 Select the EQ in/out button to put the EQ in circuit.
- 3 Drag the handles in the on-screen Dynamics graph display as follows:
 - To adjust Comp/Lim threshold and ratio, drag the blue handles.
 - To adjust Exp/Gate threshold and ratio, drag the orange handles.

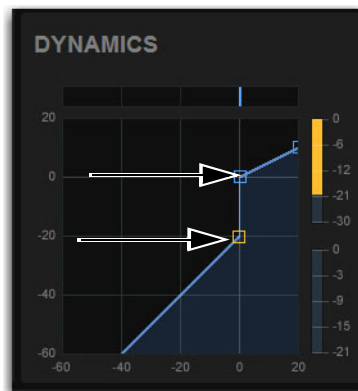

Comp/Lim handle (top, in blue) and Exp/Gate handle (bottom, in orange)

 *The Dynamics Graph does not support Fine adjust mode using the Fine switch.*

Sidechain

You can engage a built-in Dynamics processor sidechain, select the external key sidechain input, and engage key listen using the external screen. For an overview of S6L system sidechain processing, see [Sidechain](#).

Engaging the Sidechain

The sidechain must be engaged to enable both external key and EQ filter sidechain processing for the selected channel. The Key In control can be toggled in or out of circuit from Channel Control or on-screen.

To toggle the side-chain in or out of circuit from the Inputs or Outputs page:

- For Comp/Lim, select the COMP/LIM Sidechain tab, and then select the Key In button.
- For Exp/Gate, select the EXP/GATE Sidechain tab, and then select the Key In button.

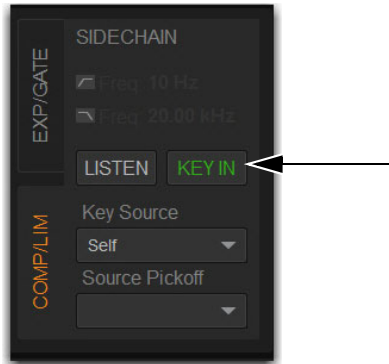

Key In button

Selecting the External Key Sidechain Input

(Key Source)

The Key Source selectors lets you select the side-chain source for either dynamics processor and its pickoff point. You can use any of the following as the key source for the Comp/Lim and the Exp/Gate:

- Self
- Any input channel
- Console hardware inputs
- You can also specify the pickoff source for the key signal for input channels.

To select the key input for the sidechain:

- 1 Go to the Inputs or Outputs page and attention the desired channel.
- 2 Select the EXP/GATE Sidechain tab in the dynamics section to select the gate.
- 3 Select the Key Source selector and choose an available channel or bus.

To select a pickoff point for the key source signal:

- Select the Source Pickoff selector and choose one of the following pickoff sources for the selected key signal: Top of Channel, Insert Return or Pre-Fader.



Key Filters are engaged and adjusted using the CKM in Channel Control mode. See [Using Sidechain EQ Filters](#).

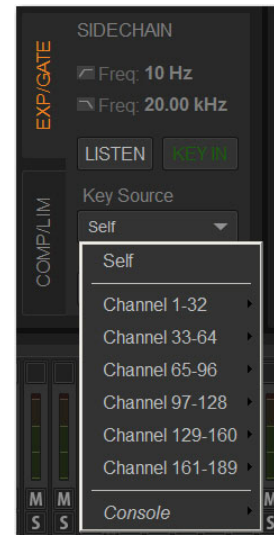

Choosing a Key Source

Key Listen

The Key Listen button toggles the key onto the Solo bus, replacing the signal there. This happens regardless of whether the key is the channel signal or the external key, or whether it has been side-chain filtered.

Key Listen always overrides all other signals on the Solo bus. If soloed channels are already on the Solo bus, they are suppressed until Key Listen is cleared. If additional channels are soloed while Key Listen is on, they will be added but suppressed.

The Key Listen solo is also exclusive to itself; pressing Key Listen on a different processor or channel turns off the previous Key Listen and the new Key Listen takes over.

⚠ *Key Listen on a dynamics plug-in does not route the signal to the solo bus, but to the plug-in output. Use caution when using the Key Listen with a plug-in dynamics processor.*

To engage Key Listen:

- Select the Listen button in the on-screen Exp/Gate controls.

To disengage Key Listen:

- Select Listen again. The Solo bus reverts to its previous signal (soloed channels, or none). You can also press Solo Clear once to turn off any currently engaged Key Listen button. Press Solo Clear a second time to clear channel solos, if any.

Input Direct

Input Direct lets you completely bypass the built-in dynamics and EQ processing, and all inserts on input channels. This mode routes the input signal directly from the Top of Channel pickoff to the channel fader.

To bypass all processing on an input channel:

- 1 Go to the Inputs or Outputs page and attention the desired channel.
- 2 Select the Input Direct button in the EQ section. All built-in channel EQ and Dynamics are bypassed, and the button flashes to indicate Input Direct mode is active.

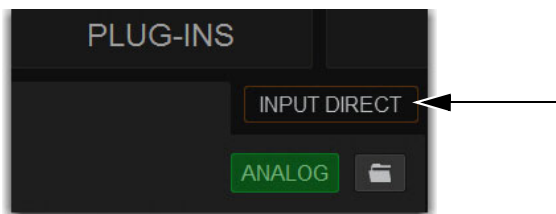

Input Direct button

Copying and Pasting Settings

Copying and Pasting Channel Settings

You can copy channel settings in their entirety from one channel and paste them to one or more channels from the Inputs and Outputs pages. Using the Events list, Copy and Paste can be assigned to any Function switch on the console. For more information, see [Events](#).

 You can also store and load settings as *Input Channel Presets*. For information, see [Input Channel Presets](#).

To copy and paste channel settings on-screen:

- 1 Go to the Inputs or Outputs page and attention the channel whose parameters you want to copy.
- 2 Touch-and-hold (right-click) within the upper channel display and choose Copy.

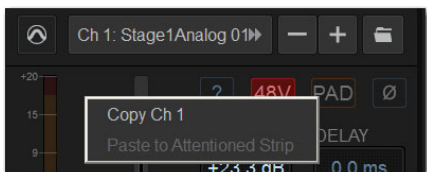

Channel Copy/Paste pop-up menu

 You do not need to select the channel before copying its settings on-screen.

- 3 Attention one or more destination channels. You can only paste to attentioned/multi-selected channels.
- 4 Touch-and-hold (right-click) on the lower fader strip on-screen, or on any non-control area of the destination channel, and choose Paste to Selected Strip(s). The status displays shows a message confirming the operation.

Parameters and Channel Types

Input channels can only be copied or pasted to other Input channels. Output channels can only be copied or pasted to other channels of the same type (such as Aux, Group, or Matrix). When pasting channel settings:

- Settings common to the source and destination channel are always pasted.
- Copied settings with no corresponding parameter in the destination channel are ignored.
- Settings in the destination channel with no corresponding parameters are left unchanged.

Copying and Pasting Mono and Stereo Channel Settings

You can copy a mono channel and paste its settings to one or more stereo channels. Mono settings are applied equally to the left and right channels of the stereo destination. The stereo destination channel retains its current balance and width settings.

You can also copy a stereo channel and paste its settings to one or more mono channels. The left channel settings of the stereo source are applied to the mono channel(s). The mono destination channel retains its current pan setting.

Settings Excluded from Copy and Paste

Input Channels The following Input channel parameters are not copied or pasted (the current settings of the destination channels are retained):

- Patchbay assignments, including Direct Outs
- Channel Name
- Hardware and software insert (plug-ins) assignments and in/out state.

Output Channels The following Output channel parameters are not copied or pasted (the current settings of the destination channels are retained):

- Patchbay assignments, including Direct Outs
- Channel Name
- Hardware and software insert (plug-in) assignments and in/out status
- GEQ settings
- Output membership (the assignment of channels to an Aux, Group VCA, or Matrix).

 *To copy GEQ settings, use the copy/paste GEQ shortcut or use GEQ Presets. Use the Replace with Mix (members) From command to replace output membership for an Aux, Group, VCA, or Matrix.*

Copying and Pasting EQ Settings

Built-in channel and Graphic EQ settings can be copied and pasted between channels. EQ presets can also be saved and loaded to archive and transfer settings.

To copy and paste an EQ setting:

- 1 Go to the Inputs or Outputs page and attention the channel whose parameters you want to copy.
- 2 Do one of the following:
 - To copy a channel EQ setting, touch-and-hold (right-click) the on-screen EQ section or EQ graph (not on an encoder) and choose Copy EQ Settings.
 - or –
 - To copy a Graphic EQ setting, touch-and-hold (right-click) the graphic EQ display (not on a fader) and choose Copy GEQ Settings.

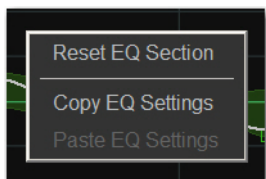

EQ Reset/Copy/Paste pop-up menu

- 3 Attention one or more destination channels. You can only paste to attentioned/multi-selected channels.
- 4 Do one of the following:
 - To paste a channel EQ setting, touch-and-hold (right-click) in the new channel's EQ section or graph and choose Paste EQ Settings. All EQ settings, including HPF settings, are copied to the new channel.
 - or –
 - To paste a Graphic EQ setting, touch-and-hold (right-click) in the new channel's Graphic EQ section and choose Paste GEQ Settings.

Copying and Pasting Dynamics Settings

Built-in dynamics settings can be copied and pasted between channels.

To copy and paste dynamics settings:

- 1 Go to the Inputs or Outputs page and attention the channel whose parameters you want to copy.
- 2 Touch-and-hold (right-click) anywhere in the Comp/Lim or Exp/Gate (input channels only) areas of the on-screen dynamics section and choose Copy <channel number/name> Settings.

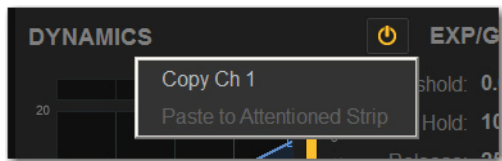

Dynamics Copy/Paste pop-up menu

- 3 Attention one or more destination channels. You can only paste to attentioned/multi-selected channels
- 4 Touch-and-hold (right-click) in the Comp/Lim or Exp/Gate areas of the on-screen dynamics section and choose Paste Comp/Lim Settings or Paste Exp/Gate Settings.

To copy and paste all of a channel's built-in dynamics settings:

- 1 Go to the Inputs or Outputs page and attention the channel whose parameters you want to copy.
- 2 Touch-and-hold (right-click) in the on-screen Dynamics Graph and choose Copy Dynamics Settings.
- 3 Attention one or more destination channels. You can only paste to attentioned/multi-selected channels
- 4 Touch-and-hold (right-click) in the on-screen Dynamics Graph of the new channel and choose Paste Dynamics Settings.

Configuring Channels on the External Screen

Naming Channels

You can name channels from the Inputs and Outputs pages. Channel names can be up to 32 characters in length. When displayed on the control surface, names are abbreviated to fit the display.

To change the name of a channel:

- 1 Go to the Inputs or Outputs page.
- 2 Attention the channel whose name you want to change.
- 3 Double-tap the channel name.

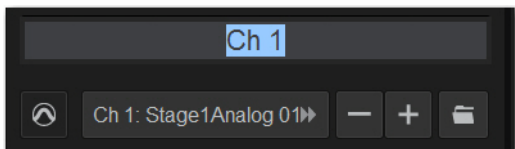

Changing the name of an Input Channel on the Inputs page

- 4 Type a new name and press Enter on the computer keyboard.

Make Selected Mono Strips Stereo/Make Selected Stereo Strip Mono

You can combine pairs of mono channels to make stereo channels, whose left and right sides are then controlled by a single channel strip on the S6L control surface and on the fader strips on the external screen. This can be useful for creating effects returns or playback channels, for example. Input and output channels can be combined into stereo channels, except VCA and the Mains. You can also split stereo channels back into mono channels

To combine two mono input channels into a single stereo channel:

- 1 Put the system into Config mode.
- 2 Multi-Select two channels.
- 3 Touch-and-hold (right-click) either of the selected mono channels on-screen and choose **Make Selected Mono Strips Stereo**.

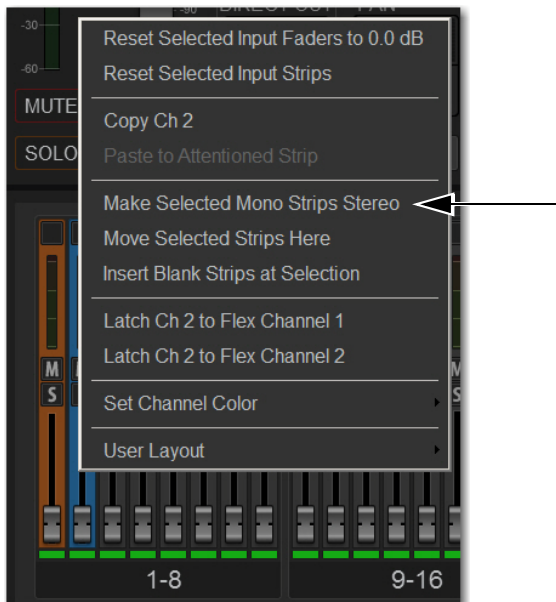

Two mono inputs about to be combined into one stereo channel

- ◆ Each selected channel is combined with the next-highest selected channel, even if the selected channels are not consecutive.
- ◆ For input channels, blank strips are created and inserted where necessary to maintain channel layout in that bank.
- ◆ For output channels, no blank strips are created or inserted, and channels in the layout in that bank are shuffled to the left, including the corresponding Aux Sends.
- ◆ Parameter values from the left most channel of each pair are applied to both channels
- ◆ The pan control becomes a Balance/Width control.
- ◆ Combined channels are shown in the Patchbay as left and right sides of the channel name. Mains and VCAs cannot be combined or split.



Stereo Input Channel on the Input tab of the Patchbay

- ◆ In the Options > Buses page for Stereo Auxes, and the Bus Assign section for stereo Groups, stereo status of a bus is indicated by two interlocking green circles.



To split a stereo channel into two mono channels:

- 1 Put the system into Config mode.
- 2 Attention the stereo channel you want to split.
- 3 Touch-and-hold (right-click) the attentioned channel and choose Split Selected Stereo Strip to Mono.
The stereo channel is split, placing the channels next to each other on the control surface and in the Patchbay. Delete blank strips manually to maintain channel layout, if necessary.

Move Selected Strip

You can move an attentioned Input, Aux, Group, or Matrix strip from its current position to a new location. When you move a channel using Move Selected Strip, other channels are moved (and renumbered) lower or higher to accommodate the moved channel.

To move a Channel strip:

- 1 Put the system in Config mode.
- 2 Go to the Inputs or Outputs > Auxes, Groups, or Matrixes page and attention the channel whose parameters you want to move.
- 3 On-screen, touch-and-hold (right-click) on the destination strip (where you want to move the attentioned channel).
- 4 Choose Move Selected Strip Here from the pop-up menu. The channel strip is moved before the destination strip.

 *Snapshots cannot store and recall custom console channel positions.*

 *You can also drag and drop channels. See [Reordering Channels Using Drag and Drop](#).*

Inserting Blank Strips

(Input Channels Only)

The Insert Blank Strip command lets you insert one or more blank (or “spacer”) strips anywhere among your input channels. In addition, blank strips are automatically inserted when you use the Make Stereo command to convert two mono input channels into a single stereo channel, preserving the channel layout.

Blank strips are strictly placeholders (no audio or any type or processing take place), and therefore consume no additional processing overhead or DSP resources. Use blank strips to create obvious divisions between groups of instruments, or to optimize the bank placement of inputs on the console. Blank strips are saved and loaded as part of the Show file.

Blank Strips on the Control Surface

A blank strip has no LCD channel name display, and all of its physical controls and indicators are inactive. Blank strip faders are set to the bottom (–inf) position and always revert to this position if moved.

Blank Strips On-Screen

On the MTS Universe view, blank strips appear as blank Channel Tiles. On the external screen, blank strips appear as a simple gray strip with no fader, buttons or meter. Insert and remove blank strips on the external screen.

Adding Blank Strips

Blank strips can be inserted manually, and are also created automatically when you use the Make Stereo command. You can also insert multiple blank strips.

To manually add a blank strip:

- 1 Enable Config mode.
- 2 Go to the Inputs or Outputs page.
- 3 Touch-and-hold (right-click) an input channel strip (or a blank strip) at the location where you want to insert a blank strip and choose Insert Blank Strip. For example, if you want to have a blank strip at channel strip 16, touch-and-hold (right-click) on channel 16.

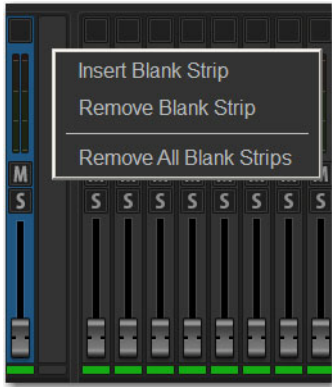

Blank strip menu

All channels to the right of the insertion point are shuffled one position to the right.

To insert multiple blank strips:

- 1 Enable Config mode.
- 2 Create a multi-selection of channels.
- 3 Touch-and-hold (right-click) on one of the selected channels and choose Insert Blank Strips at Selection.

A blank strip is inserted in place of each selected channel strip, shifting all channels accordingly and maintaining the multi-selection.

Blank Strips When Using Make and Split Stereo

VENUE automatically creates blank strips when you use the Make Stereo command in order to preserve the current channel layout. Similarly, blank strips may be automatically removed when you use the Split Stereo command to revert a stereo strip to its two contributing mono channels.

Make Stereo A blank strip is automatically inserted at the location previously occupied by the right-side channel of the newly-formed stereo pair. There is no shuffling of the remaining input channels as a result of this operation.

Split Stereo The behavior when splitting a stereo strip into two mono strips is as follows:

- If a blank strip is located immediately adjacent to the (previously) stereo channel, the right channel of the stereo pair occupies this position and the blank strip is automatically removed. No other channels shuffle.
- If no blank strip is located immediately adjacent to the (previously) stereo channel, all channels to the right of the split point shuffle one position to the right and the right channel of the stereo pair is inserted.

Removing Blank Strips

To remove a blank strip:

- Touch-and-hold (right-click) the blank strip you wish to remove and choose Remove Blank Strip.

To remove all blank strips:

- Touch-and-hold (right-click) any blank strip and choose Remove All Blank Strips. Blank strips are removed and all channels to the right are shuffled to the left.

Reordering Channels Using Drag and Drop

You can reorder Input channels, Auxes, Groups, and Matrixes by dragging and dropping on-screen. You can reorder any channels in a User Layout, including output channels. When you reorder channels, the location of the channel changes on the control surface and on-screen. The original hardware input for the channel remains the same, and all other channel parameters are preserved.

To reorder a channel:

- 1 Put the system into Config mode.
- 2 Go to the appropriate page on the external screen, depending on where you want to reorder channels:
 - To reorder input channels, go to the Inputs page and select the Inputs tab.
 - To reorder output channels, go to the Outputs page and select the Aux, Groups, or Matrixes tab.
 - To reorder channels in a User Layout, go to the Inputs or Outputs page, and then select the Layouts tab.
- 3 Attention the channel you want to move.
- 4 Touch-and-hold the channel then drag it to the desired location., denoted by the orange line, then release your finger.

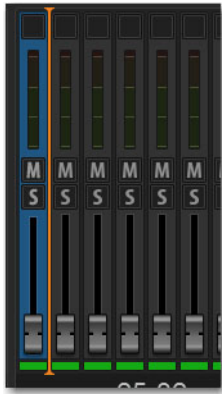

Reordering an Input channel using drag and drop



You can select and reorder multiple input channel strips. Shift-Touch multiple fader strips and drag them to the new location.



Channels can also be moved using the Move Selected Strip command. See [Move Selected Strip](#).

Inserting Plug-Ins on Channels

You can insert plug-ins on input and output channels directly from the Inputs or Outputs page, or from the Plug-In Rack. For complete information on routing and inserting plug-ins, see [Routing Plug-Ins](#).



You can also insert outboard hardware. See [Hardware Inserts](#).

Input Channel, EQ, and Dynamics Presets

You can use Presets to store and load input channel settings, built-in channel EQ and GEQ settings, and Dynamics settings from the Inputs and Outputs pages.

 For information about managing Presets files and folders, see [Working with Presets](#)

Input Channel Presets

You can store and load input channel configurations as Input Channel Presets. Input Channel Presets can be previewed, loaded and transferred just like other Preset files, letting you quickly configure channels from among a library of favorite setups.

When an Input Channel is stored or recalled as a preset, all parameters are affected except the following:

- Patchbay assignments, including Direct Outs
- Hardware and software insert (plug-in) assignments and in/out state.

 *Choosing a preset automatically loads the saved settings into the attentioned channel. Depending on the stored settings this may dramatically change channel level and signal routing. Use caution when previewing Input Channel Presets with a live source.*

To store a channel as an Input Channel Preset:

- 1 Adjust parameters as needed.
- 2 Go to the Inputs or Outputs page.
- 3 Attention the channel whose settings you want to save or load.
- 4 Under the channel name, select the Presets Folder icon to open the Input Channel Presets window.

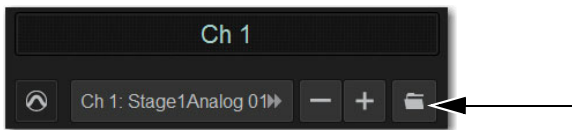

Channel Presets icon in the Inputs page

- 5 Choose a Presets folder from the Folder pop-up menu.

 See [Creating Preset Folders](#) to create your own Presets folder so they show up in a Presets Folder pop-up menus.

- 6 Select New, enter a name for the Preset, then select OK, or choose Cancel to exit the Presets folder without making changes.

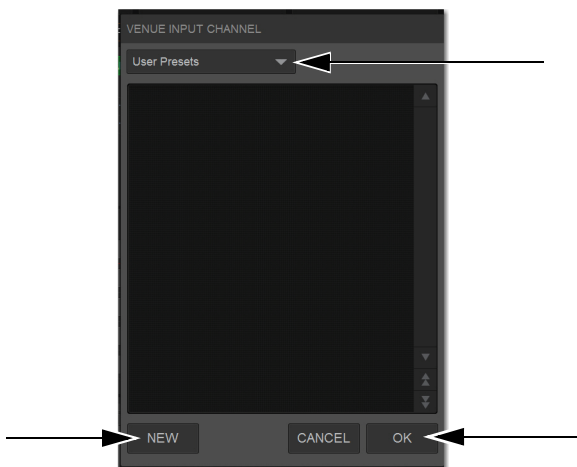

Input Channel Presets window showing the Folder pop-up menu (top) and the New and OK buttons (bottom)

To preview and load a saved Channel Preset:

- 1 Navigate to the Inputs page for the desired channel. Channel Presets can only be loaded into a single channel at a time.
- 2 Select the Channel Presets icon to open the Presets window.
- 3 Choose a Presets folder from the Folder pop-up menu.
- 4 Do any of the following in the Presets window:
 - To preview an existing preset, select its name in the Presets window so it is highlighted.
 - To load the currently selected preset, select OK.
 - To load a preset and close the Presets window, double-tap the preset.
 - To cancel without changing settings, choose Cancel.

To rename, duplicate, overwrite or delete a Channel Preset:

- Touch-and-hold (right-click) the preset name in the Preset window, then choose Rename, Duplicate, Delete, or Overwrite.

Channel Compatibility and Input Channel Presets

The following describe how different types of channel data is handled when storing or loading Input Channel Presets:

Channel Names and Presets New presets automatically inherit the current Input Channel Name, or you can give them a custom name in the Presets window. The default channel number (such as “Ch 16”) is used for the preset name if the channel has an empty (null) name.

Loading Mono to Stereo Mono settings are applied equally to the left and right channels of the stereo destination. The stereo destination channel retains its current balance and width settings.

Loading Stereo to Mono When loading a stereo preset into a mono Input Channel, the left channel settings in the stereo preset are applied to the mono destination channel. The mono destination channel retains its current pan setting.

Groups Group bus assignments are not applied if the settings in the preset do not match the current system Bus Configuration

Aux Sends Aux send level or pan settings for individual Aux sends are not applied if the stored mono/stereo state does not match the current mono/stereo state. For example, assume the stored preset has Aux 1–2 combined as a stereo channel, but the current system configuration has these Auxes as individual mono Auxes. When the preset is recalled Aux 1 and Aux 2 will retain their current settings (they will not be updated), while all other Auxes are updated to the preset settings.

Presets for Built-In Channel EQs, Graphic EQs, and Dynamics

You can save and load built-in channel EQ, GEQ, and Dynamics settings as Preset files. Preset files are stored in Preset Folders, and can be moved between systems and used with other Show files. Each processor has its own Presets folder in which settings are stored and from which they are loaded. GEQ settings can only be accessed from the Outputs page.

To save or load presets:

- 1 Adjust parameters as needed.
- 2 Go to the Inputs or Outputs page and attention the channel whose settings you want to save or load.
- 3 Depending on the processor settings you want to save, select the corresponding Presets folder icon to open the Presets window.

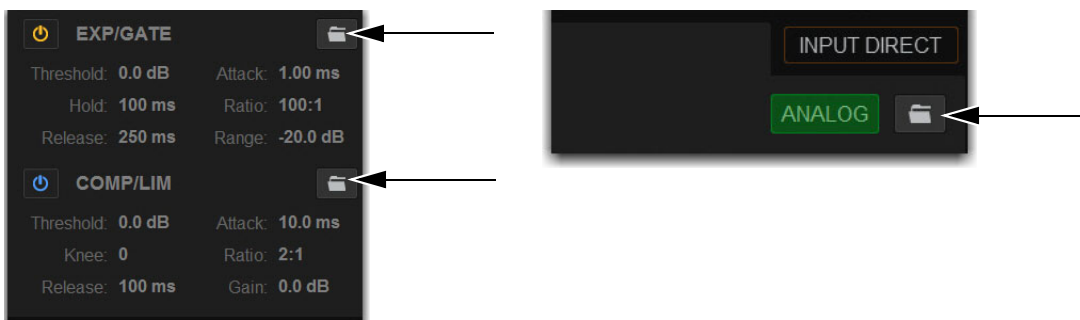

Dynamics Presets Folder icons (left) and the channel EQ Presets Folder icon (right)

4 Choose a Presets folder from the Folder pop-up menu.

 You can create your own Presets folder from the Filing page, which then shows up in any Presets Folder pop-up menu. See [Creating Preset Folders](#)

5 Do any of the following in the Presets window:

- To save the current settings as a new preset, choose **New** and enter a name for the preset file. All processor settings are saved to the preset.
- To preview an existing preset, select its name in the Presets window so it is highlighted.
- To load the currently selected preset, select **OK**.
- To load a preset and close the Presets window, double-tap the preset.
- To cancel without changing settings, choose **Cancel**.

 Check the **Factory Presets** folder for pre-configured settings, where available.

To rename, duplicate, overwrite or delete a Preset:

- Touch-and-hold (right-click) the preset name in the Preset window, and then choose **Rename**, **Duplicate**, **Delete**, or **Overwrite**.

Assigning Channels to Buses and VCAs on the External Screen

You can assign channels to buses and VCAs on the external screen.

To assign channels to the Mains or Groups on the external screen:

- 1 Go to the Inputs or Outputs page, depending on the type of channels you want to assign.
- 2 Select the Inputs or Outputs tab.
- 3 Use the Input Channel Bank buttons or the Output Channel Type buttons to bank those channels to the fader strips.

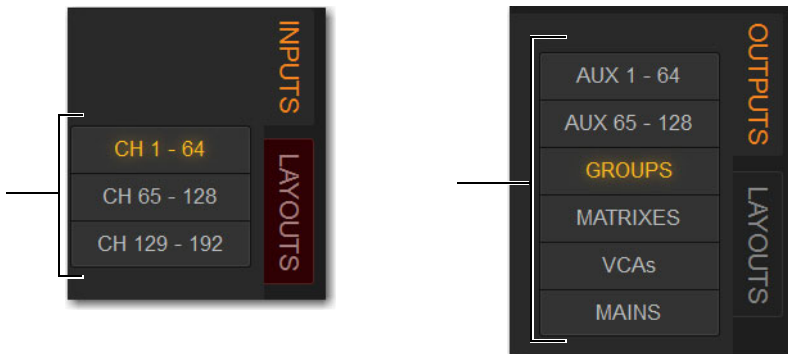

Input Channel Bank buttons (left) and Output Channel Type buttons (right)

4 Attention one or more channels.

5 In the Bus Assign section, do any of the following:

- To assign to Mains Left-Right, select the **L-R** button so it lights.
- To assign to the Center/Mono bus, select the **C/Mono** button so it lights.
- To assign to a Group, select Groups 1–x, as available, so they light. A group with a single yellow ring is mono, and interlocking green rings is stereo.

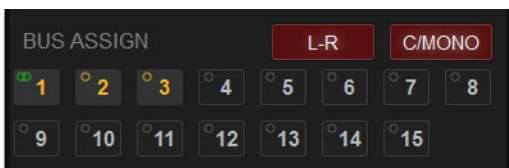

Bus Assign section showing a channel assigned to Mains L-R, C/Mono, and Groups 1, 2, and 3

To assign channels to Aux buses on the external screen:

- 1 Go to the Inputs page.
- 2 Select the Inputs tab, then select the bank of input channels you want to access using the Input Channel Type buttons.
- 3 Attention an input channel.
- 4 In the Aux Sends section, select the thermometer-style indicator. When the indicator lights, the send is on. The indicator lights in the color assigned to that Aux output.
- 5 To toggle an Aux Send pre-/post-fader, select the Aux Send number. When set to pre-fader, a border appears around the Aux Send number.

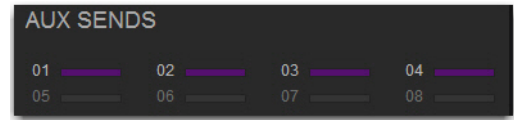

Managing Output Channel Assignments (Members)

You can view, reset, clear and copy (duplicate) Mains, Aux, Group, Matrix, and VCA assignments (members) on the external screen.

Viewing Output Assignments

When an output channel is targeted on-screen, its members are shown in the Members list on the right side of the Outputs page.

To view input assignments to an output:

- 1 Go to the Outputs page.
- 2 Select the Output Channel Type tab to show those channels on the screen.
- 3 Attention the desired output channel. Channels assigned to the attentioned output channel are displayed in the Members list on the right side of the page.

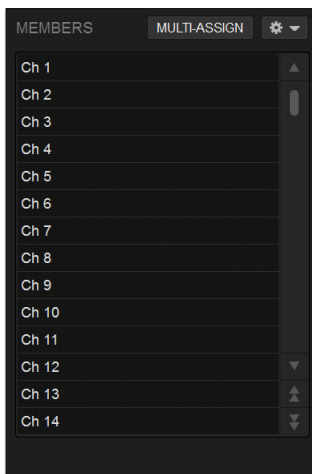

Channel assignments shown in the Members list

To jump to any assigned input channel from the Outputs page:

- Select the name of the input channel in the Members list.

Removing and Resetting Assignments

You can remove input assignments from an output on-screen.

To remove one input assignment from an output:

- 1 Attention the output channel you want to change so that its members are displayed on-screen.
- 2 In the Members list, touch-and-hold (right-click) the input assignment you want to remove and choose Unassign.

To remove all input assignments:

- 1 Attention the output channel you want to change so that its members are displayed on-screen.
- 2 Select the pop-up menu at the top of the Members list (gear icon), and choose **Reset Mix** (for buses) or **Clear All Members** (for VCAs).



Removing all input assignments from a bus

Copying Assignments Between Outputs

You can copy the current input assignments from one output to another of the same type. This lets you quickly duplicate monitor mixes.

⚠ Copying Aux bus assignments overwrites all the assignments on the destination Aux bus.

To copy input assignments between buses:

- 1 Attention the output channel to which you want to copy assignments.
- 2 Select the pop-up menu at the top of the Members list (gear icon), choose **Replace With Mix From**, and then from the list choose the bus whose assignments you want to copy to the currently attentioned bus.



Copying input assignments between Aux buses

Color-Coding Channels from the External Screen

You can color-code channels to help identify key channels or groups of channels faster on the Inputs or Outputs page.

To set a channel color on the external screen:

- 1 Touch-and-hold (right-click) a fader strip on-screen, or select multiple channels and right-click any of the multi-selected faders.
- 2 From the pop-up, select **Set Channel Color** and choose one of the available color options.

The color coding is reflected in the MTS channel tiles; on the CTM for the color-coded channels; on the Channel Color switch; on the CKM encoders for Aux Sends, Matrix input controls, Group assignment controls, and Mains assignment control; and on the fader strips and the Aux Sends section on the external screen.

💡 You can also color-code channels from the MTS. See [Color-Coding Channel from the Universe View](#).

Filing

Data can be stored, recalled and transferred between VENUE systems, as well as VENUE Standalone software, using the Filing page. There are three types of information files that can be managed separately, as follows:

Show Files These files are used to store, recall and transfer system settings, snapshots, and events. (Snapshots and events can also be imported from Show files.)

Preset Files These files are used to store settings for input channels, built-in processors and plug-ins, User Layouts, Recall Safe Scope Sets, and Events.

Console Setting Files These files are used to transfer or back up the current state of the S6L system.

! *The system does not need to be in Config mode to carry out many file management tasks. However, the system must be in Config mode to load Shows. This minimizes the chance of an accidental interruption of audio throughput.*

Creating Shows

A Show file contains all configuration, signal routing, mixer settings, plug-in information, snapshots, and other operational settings. Shows are grouped together in Show Folders.

Show Folders

Show Folders contain Show files. You can create and manage Show Folders from the Save tab of the Filing page.

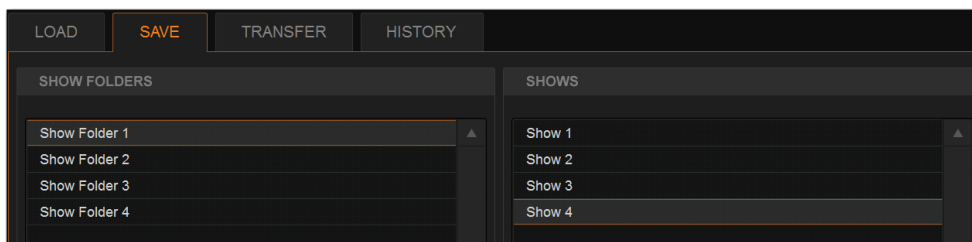

Show Folders and Show files in the Save tab of the Filing page

Creating Show Folders

To create a new Show Folder:

- 1 Go to the Filing page and select the Save tab.
- 2 In the Show Folders column, select the New button.
- 3 Type a name for the Show Folder and press Enter.

! *You can also touch-and hold (right-click) any folders and file names in the Filing page columns and choose the relevant command from the pop-up.*

Duplicating Show Folders

To duplicate a Show Folders:

- 1 In the Show Folders column, select a Show folder so it is highlighted.
- 2 Select the Duplicate button.

The folder and all of the Show files it contains are duplicated.

Renaming Show Folders

To rename a Show Folder:

- 1 In the Show Folders column, select a Show folder so it is highlighted.
- 2 Select the Rename button.
- 3 Type a new name for the Show folder and press Enter.

Deleting Show Folders

When you delete a Show Folder, all Show files contained in that folder are also deleted.

To delete a Show Folder:

- 1 In the Show Folders column, select a Show folder so it is highlighted.
- 2 Select the Delete button.

Show Files

Creating a Show File

When you create a new Show file, it captures the current state of the system. Show files are automatically saved when they are created.

To create a new Show file:

- 1 Go to Filing > Save.
- 2 In the Show Folders column, select the Show folder where you want to save the Show.
- 3 In the Shows column, select the New button. The new Show file captures the current state of the system.
- 4 Type a name for the Show file and press Enter.
- 5 Double-tap in the Notes field for the Show and type any comments you want to save with the Show.

Information about the Show file is shown in the Info area of the Filing page.

 *Show files are automatically saved when they are created; no further action is required to save them.*

Overwriting (Updating) a Show File

You can also update an existing Show file by overwriting it.

To update (overwrite) an existing Show file:

- In the Shows column, touch-and-hold (right-click) the Show file name you want to overwrite, and choose **Overwrite** from the pop-up menu. The current state of the system is saved to the selected Show file.
 - or –
- Press the **Over Write** switch on the MLM.

Duplicating Show Files

To duplicate a Show file:

- In the Shows column, touch-and-hold (right-click) the Show file name you want to overwrite, and choose **Duplicate** from the pop-up menu.

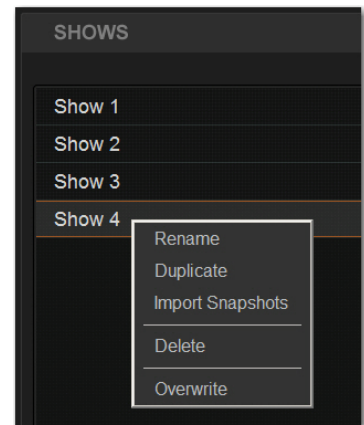

Renaming Show Files

To rename a Show file:

- 1 In the Shows column, select a Show file name so it is highlighted.
- 2 In the Shows column, select the Rename button, then type a new name for the Show file and press Enter.

Deleting Show Files

To delete a Show file:

- 1 In the Shows column, select a Show file name so it is highlighted.
- 2 In the Shows column, select the Delete button.

Loading a Show

You can load a Show file using the Load tab of the Filing page. Show files are stored locally on your system. Show files can be stored on USB drives, but must first be transferred to the system before loading (see [Transferring Settings, Shows and Presets](#)). The system must be in Config mode to load Shows.

! *Loading a Show automatically replaces the current system settings, and may interrupt audio throughput.*

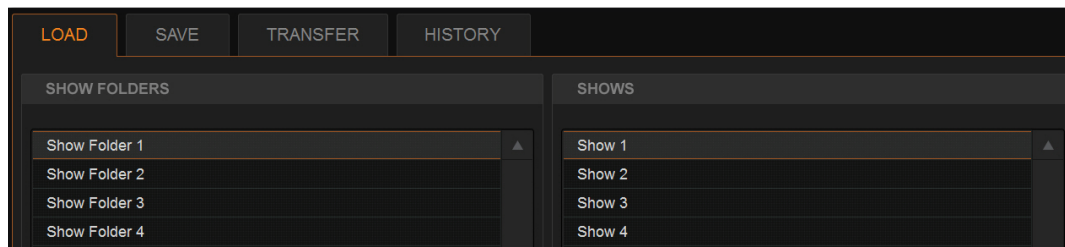

Show Folders and Show files in the Load tab of the Filing page

To load a Show file:

- 1 Put the system into Config mode.
- 2 Go to the Filing page and select the Load tab.
- 3 In the Show Folders column, select a Show Folder name to select the folder. Any Show files in the folder are displayed in the Shows column.
- 4 In the Shows column, select a Show file name so it is highlighted.
- 5 Select the Load button. The system loads the new Show file, replacing the current system configuration, routing, and control settings with those contained in the new file.

System Configurations and Loading Shows

Show files include system configuration settings such as the type of control surface; the type of Engine and the number of HDX Mix Engines; and Mains and Mix (Aux/Group) Bus configurations.

- If a Show file includes the same system configuration settings as the current configuration, the configuration information appears in blue text in the Info area.
- If a Show file differs from the current configuration, but can be loaded on the system, the relevant configuration changes appear in orange text in the Info area.
- If a Show file differs from the current configuration and cannot be loaded on the system in its entirety, the configuration information appears in red text in the Info area.
- If a Show file includes active Event triggers that would not be activated when the Show is loaded due to the current state of the control surface, a confirmation dialog appears letting you ignore those triggers or automatically activate them on Show load.

Working with Presets

Preset files are used to store, recall and transfer factory or user-defined presets. Preset files are grouped in the following types of Preset Folders:

Built-in Channel EQ, 31-band Graphic EQ, Compressor/Limiter, Expander/Gate, and Input Channel Presets.

Plug-In Plug-ins Settings Files.

Scope Set Settings for Recall Safe and User Aux Scope configurations.

User Layout Custom User Layouts.

Events Event definitions



For information on saving, previewing and loading presets, see any of the following: [Input Channel, EQ, and Dynamics Presets](#), [Plug-In Presets and Snapshots](#), [Using Scope Sets](#), [Working with User Layout Presets](#), or [Events Presets](#).

Preset Folders

Preset Folders contain Preset files. Each of the built-in processors and each plug-in has its own Factory Defaults folder containing pre-defined Presets. A User Presets folder, for storing your Presets, is also provided.

You can create additional Preset Folders and store new Presets in them. These folders can then be transferred to a portable storage device for transfer to other VENUE systems.

Creating Preset Folders

To create a new Preset Folder:

- 1 Go to the Filing page and select the Transfer tab.
- 2 In the center column, select Preset Folders. A list of Preset Folders appears in the left column.
- 3 In the left column, select the New button.
- 4 Type a name for the Preset Folder and press Enter.

The new Preset Folder is available in the Preset window for each processor or plug-in.



You can also touch-and hold (right-click) any folders and filenames in the Filing page columns and choose the relevant command from the pop-up.

Duplicating Preset Folders

To duplicate a Preset Folder:

- 1 In the left column, select a Preset Folder so it is highlighted.
- 2 Select the Duplicate button.

The folder and all of the Preset files it contains are duplicated.

Renaming Preset Folders

To rename a Preset Folder:

- 1 In the left column, select a Preset Folder name so it is highlighted.
- 2 Select the Rename button.



You can also touch-and-hold (right-click) a Preset Folder name and choose Rename, or double-click a Preset Folder name to rename the folder.

- 3 Type a new name for the Preset Folder and press Enter.

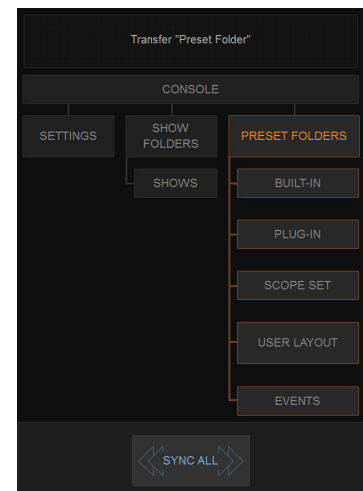

Preset Folder

Deleting Preset Folders

When you delete a Preset Folder, all Presets contained in that folder are also deleted.

To delete a Preset Folder:

- 1 In the left column, select a Preset Folder name to select it.
- 2 Select the Delete button.

Preset Files

You can manage Preset files from the Transfer tab of the Filing page. You cannot create Preset files from the Filing page. Preset files are created from the Presets window of the channel, processor, or plug-in. Scope Sets are created using the Scope Sets window of the Snapshots page Recall Safe tab. User Layouts are created from the User tab of the Inputs or Outputs page, and Events Presets from the Events Presets window of the Control > Events page.

Duplicating Presets

To duplicate a Preset file:

- 1 Go to the Filing page and select the Transfer tab.
- 2 Select any of the following:
 - Select Built-In or Plug-In then choose a processor or plug-in from the pop-up menu. The available Preset Folders for the processor or plug-in appear in a pop-up menu above the left column.
 - Select Scope Set to select Recall Safe (Scope Sets) or User Aux Scope presets to transfer.
 - Select User Layout to select User Layouts to transfer.
 - Select Events to select Event definitions to transfer.

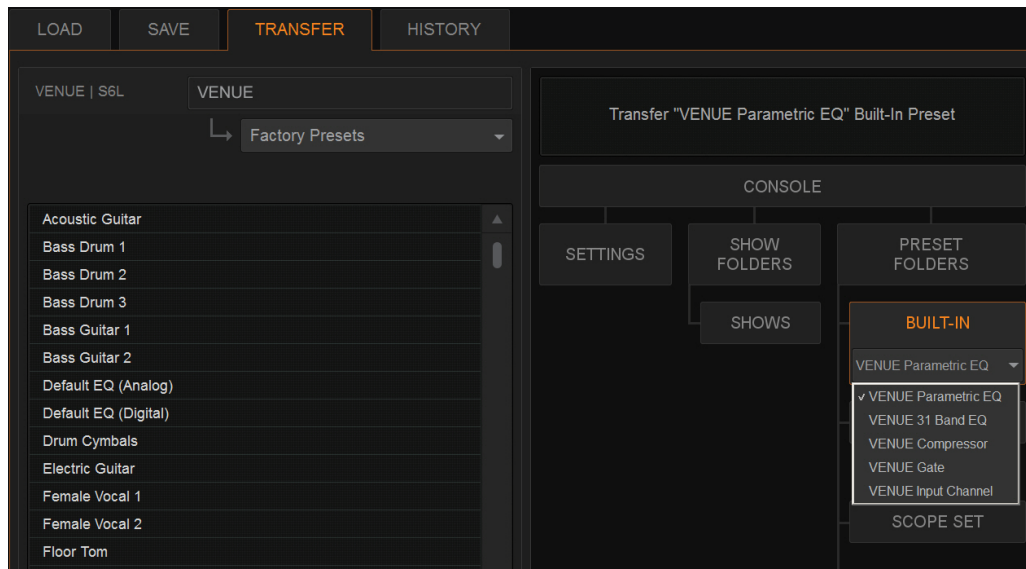

Built-In EQ in the Transfer tab of the Filing page

- 3 In the left column, choose a Preset Folder from the pop-up menu. Any Presets in the folder appear in the left column.
- 4 In the left column, select a Preset file name so it is highlighted.
- 5 Select the Duplicate button.

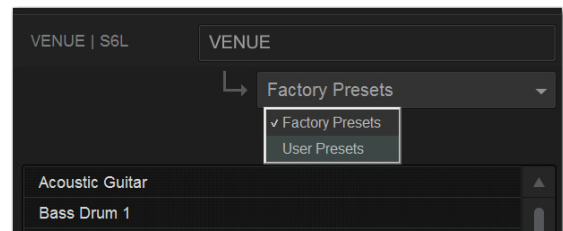

Renaming Presets

To rename a Preset file:

- 1 In the left column, select a Preset file name so it is highlighted.
- 2 Select the Rename button.
- 3 Type a new name for the Preset file and press Enter.

Deleting Presets

To delete a Preset file:

- 1 In the left column, select a Preset file name so it is highlighted.
- 2 Select the Delete button.

Transferring Settings, Shows and Presets

You can copy Console Settings, Shows, and Presets to and from a portable storage device (such as a USB flash drive) for backup, transfer from standalone software, and transfer between systems.



Console Settings are equivalent to an auto-saved Show file, and store the current state of the system. By transferring Console Settings, you can transfer the current state of the system without having to first create and name a Show file.

Settings, Shows and Presets cannot be loaded onto the destination system directly from the portable storage device, but must first be transferred to the system before loading. Transfer of Settings files, Show files, and Preset files is managed from the Transfer tab of the Filing page. The left column shows files on the system. The right column shows the contents of the portable storage device in the right column. Items are selected for transfer in the center.

To transfer Settings, Shows or Presets between your system and a portable storage device:

- 1 Go to the Filing page and select the Transfer tab.
- 2 Connect a portable storage device such as a USB flash drive to the S6L control surface. The device appears above the right column.
- 3 Do one of the following to select the type of data to transfer:
 - To transfer all data, select **Console**.
 - To transfer Console Settings, select **Settings**.
 - To transfer Show Folders, select **Show Folders**.
 - To transfer individual Shows, select **Shows**.
 - To transfer Preset Folders, select **Preset Folders**.
 - To transfer Presets for individual items, select **Built-In** or **Plug-In** and choose a built-in processor or plug-in, or **Input Channel** from the pop-up menu.
 - To transfer Scope Sets for Recall Safe or User Aux Scope, select **Scope Sets** and then choose the desired type (Recall Safe or User Aux Scope) from the pop-up menu.
 - To transfer User Layouts, select **User Layouts**.
 - To transfer Events, select **Events**.

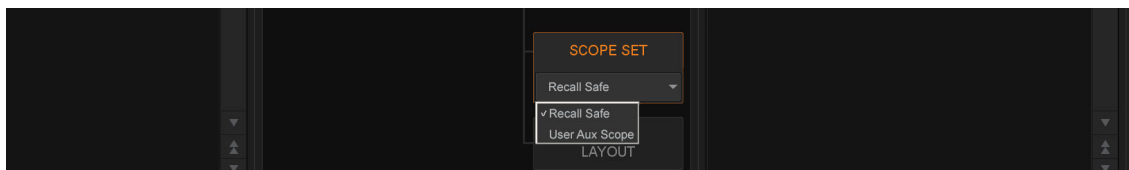

Selecting Recall Safe or User Aux Scope

4 Do one of the following to select the items to transfer:

- In the left column, select the items you want to transfer to the portable storage device.
- or –
- In the right column, select the items you want to transfer from the portable storage device to your system.

⚠ *To transfer Console and Console Settings from an external device to your system, first enable Config mode.*

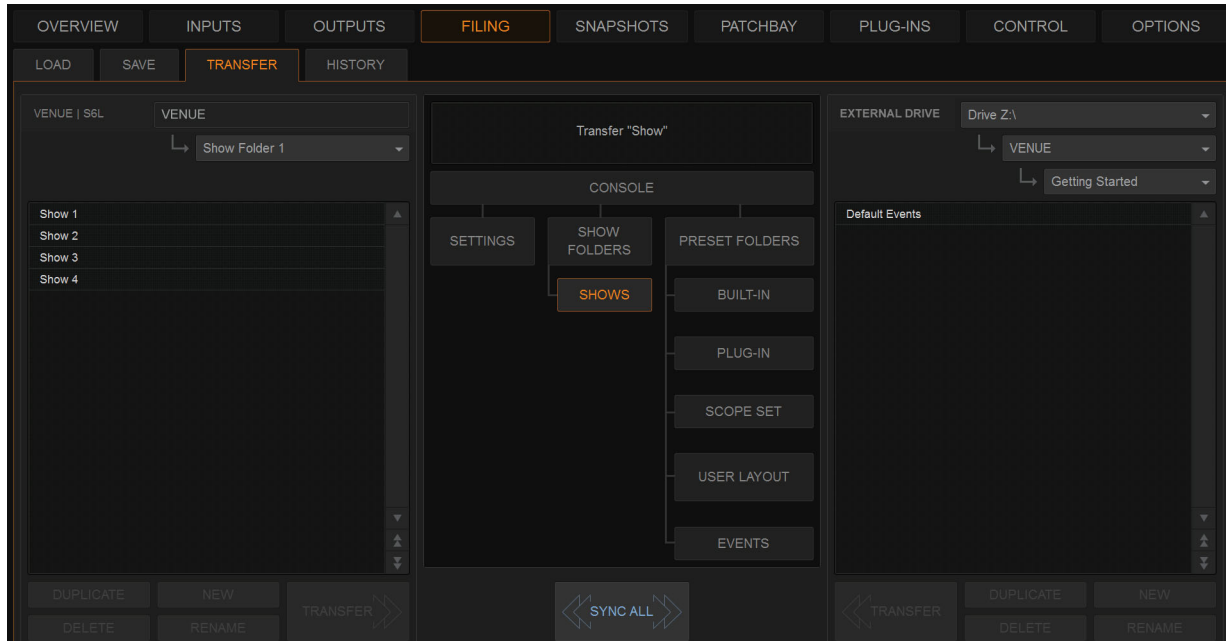

Preparing to transfer a Show file to a USB storage device

5 Select the Transfer button.

Large transfers may take time. Transfer status is shown by a progress bar. A transfer may be canceled by selecting Cancel.

⚠ *Canceled transfers may result in partial folder contents, which will have to be deleted manually.*

Synchronizing Settings, Shows and Presets

Instead of transferring data in one direction between the VENUE system and a portable storage device, you can synchronize all data in both columns of the Transfer tab in a single operation.

Synchronizing data causes new files to be copied and files with the same name but a more recent modification date/time to be automatically updated on both devices.

⚠ *When synchronizing data, the VENUE software replaces data files of the same name with the file that has the most recent date/time. Check to be sure that the system clock times and time zones are correctly set on the system and on the computer running the Standalone software when preparing data for synchronization.*

To synchronize Settings, Shows, or Presets between the VENUE system and a portable storage device:

- 1 Go to Filing > Transfer.
- 2 Connect a portable storage device (such as a USB flash drive) to a USB port on the S6L control surface. The device appears above the right column.

- 3 Do one of the following to select the type of data to synchronize:
 - To synchronize all data, select the **Console** icon.
 - To synchronize Console Settings, select the **Settings** icon.
 - To synchronize Show Folders, select the **Show Folders** icon.
 - To synchronize individual Shows, select the **Show** icon.
 - To synchronize Preset Folders, select the **Preset Folders** icon.
 - To synchronize Presets for individual items, select the **Built-In** icon or the **Plug-In** icon and choose a processor or plug-in from the pop-up menu.
 - To synchronize Scope Sets for Recall Safe, select **Scope Sets**
 - To synchronize User Layouts, select **User Layouts**.
- 4 From the pop-up menus above each column, choose the folders containing the elements you want to synchronize.
- 5 Select the **Sync All** button. The contents of the left and right columns are synchronized.

Import Snapshots and Events

You can import Snapshots and Events from available Show files using the **Import** features on the **Filing** page. Importing snapshots or events *adds* the imported items to the corresponding list (unlike **Events Presets** which *replace* all items in the Events list).

 *The right-click snapshots command **Import** that was available in previous versions of VENUE software for S6L is no longer in the right-click menu. Use the **Import** button in the **Filing** page instead.*

To import snapshots or events:

- 1 Make sure the Show file containing the desired items is present on your system. If not, use the **Transfer** page to do so.
- 2 Go to the **Filing** page and select the **Load** or **Save** tab.
- 3 Select the Show folder that contains the Show file from which you want to import.
- 4 In the Shows column, select the Show file from which you want to import.
- 5 Touch the **Import** button and choose **Import Snapshots** or **Import Events** from the pop-up menu.

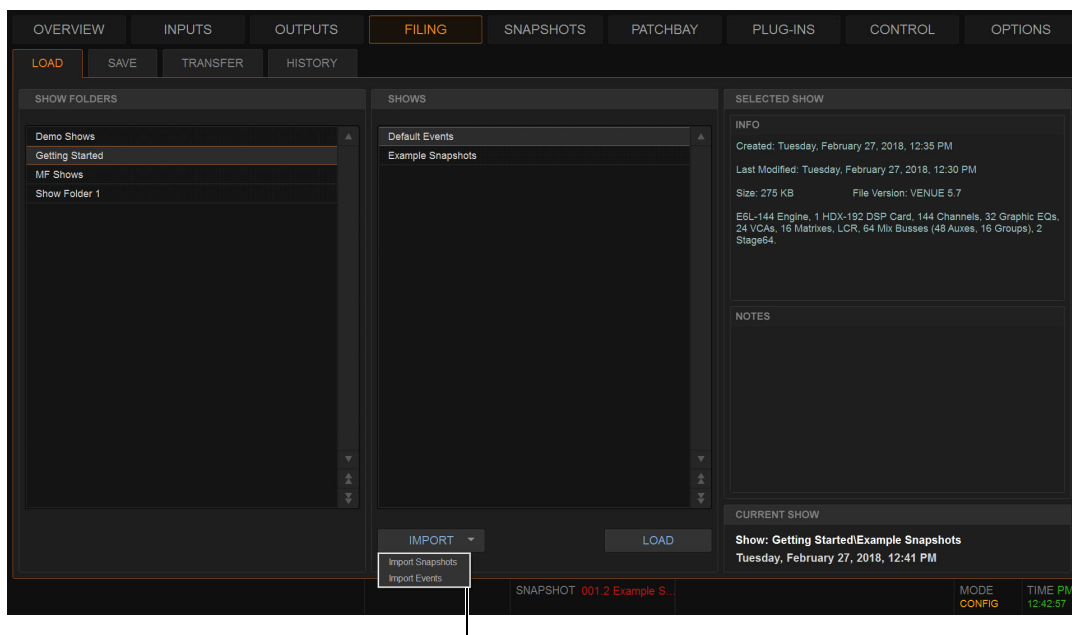

Import pop-up in Filing > Load

6 In the Import Snapshots or Import Events window, select one or more items so they are highlighted in the list.

When selecting snapshots:

- Selecting a Parent snapshot selects all its affiliated Child snapshots.
- Selecting a Child snapshot but not its Parent will result in the Child snapshot being redesignated as a Parent after it is imported.
- To deselect a selected snapshot, hold Ctrl and tap the snapshot you want to remove from the selection.

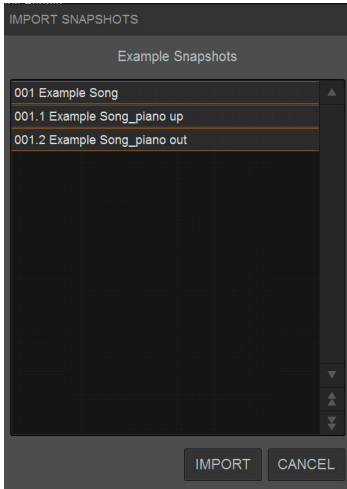

Import Snapshots

7 Tap the Import button.

The selected items are added to the Snapshots or Events list of the currently loaded Show and have an asterisk (*) added to the end of their snapshot or event name.

 *Any single Show file can contain a maximum of 999 snapshots and up to 999 events.*

Undoing Changes Using the History Feature

The VENUE system automatically saves the current state of the system while you are working, allowing you to quickly return the system to a previous state.

The History feature uses Show files to capture the system state, and displays the files in the History tab.

 *Show Folders and Show files displayed in the History tab can only be loaded or deleted. They cannot be duplicated or renamed.*

Show Folders in the History tab

There are two Show Folders in the History tab:

- ◆ The *Most Recent Changes* folder includes all auto-saved Show files for a ten-hour period.
- ◆ The *Previous Days* folder includes only the last auto-saved Show file for each day since the system was last cleared.

Show Files in the History tab

The auto-saved Show files displayed in the History tab are named according to the date and time of their creation, and cannot be renamed.

The Notes field for each auto-saved Show file includes a description of the conditions that caused the automatic save.

Several conditions cause the system to automatically save a new Show file in the History tab, as follows:

- ◆ In the course of normal work, a new Show file is automatically saved in the History tab approximately every ten minutes. Saves are less frequent when the system is idle.
- ◆ A new Show file is automatically saved just prior to a significant change in the system setup, including:

- Change of system channel or bus configuration
- Recall, storage, or modification of a Snapshot
- Loading of Console Settings or a Show

Loading an Auto-Saved Show

To return the system to an earlier state at any time, you can load any of the auto-saved Show files displayed in the History tab.

To load an auto-saved Show file:

- 1 Go to the Filing page and select the History tab.
- 2 In the Show Folders column, select the Show Folder name to select the folder and display its contents in the Shows column.
- 3 In the Shows column, select the name for the Show you want load.

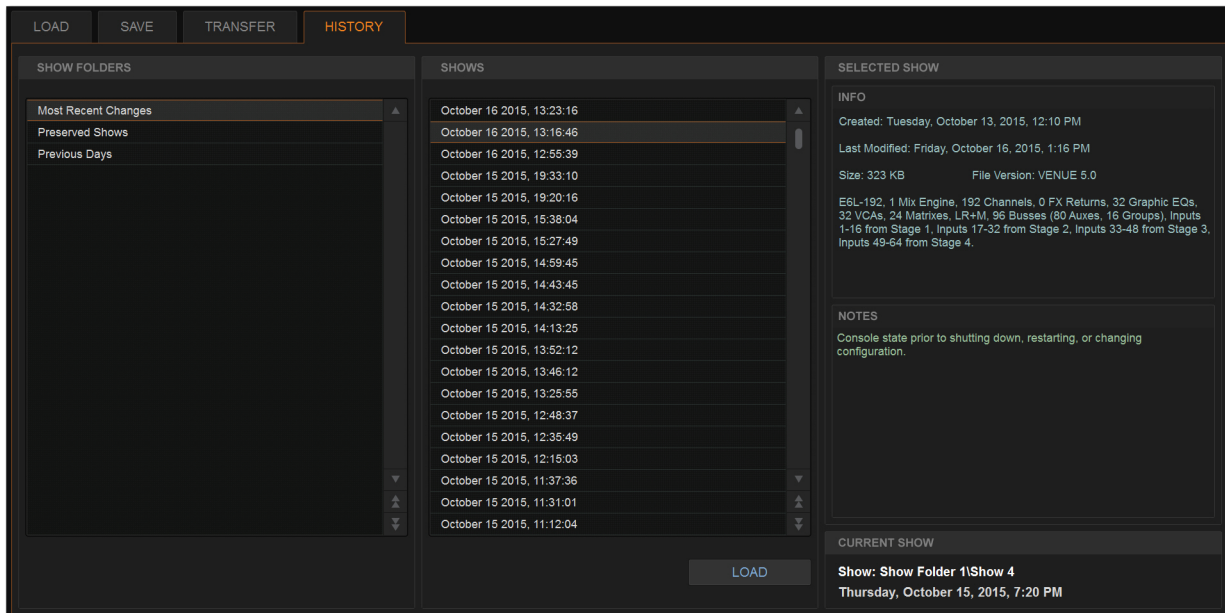

The History tab of the Filing page

- 4 Select the Load button.

The VENUE system loads the selected Show file, replacing the current system configuration, routing, and control settings with those contained in the selected file.

Snapshots

Snapshots let you flexibly store and recall a wide range of mixing parameters. Snapshots are commonly used to store the mixer setup and levels for individual scenes, songs or sound cues in a performance. Snapshots store information about channels and mix parameters, and you can use a variety of methods to edit, preview, filter, and manage snapshot data.

Snapshots are contained and stored as part of a Show file. A single Show file can contain up to 999 snapshots. Once stored, snapshots can be recalled manually or automatically (triggered by events or incoming time code). Snapshots are controlled from the on-screen Snapshots page.

This section covers the following topics:

- [Snapshots Page Overview](#)
- [Creating Snapshots](#)
- [Hierarchical Snapshots \(Parent and Child Snapshots\)](#)
- [Momentary Snapshots](#)
- [Snapshot Groups](#)
- [Recalling Snapshots](#)
- [Managing Snapshots](#)
- [Making Changes to Snapshots](#)
- Using [Preview Mode](#)
- [Adding MIDI and Plug-In Data to Snapshots](#)
- [User Aux Scope](#)
- Using [Recall Safe](#)
- [Automation Safing Channels](#)

Snapshots Page Overview

The Snapshots page provides controls for storing, recalling, and managing snapshots, providing a central location for setting up and replaying automated performances.

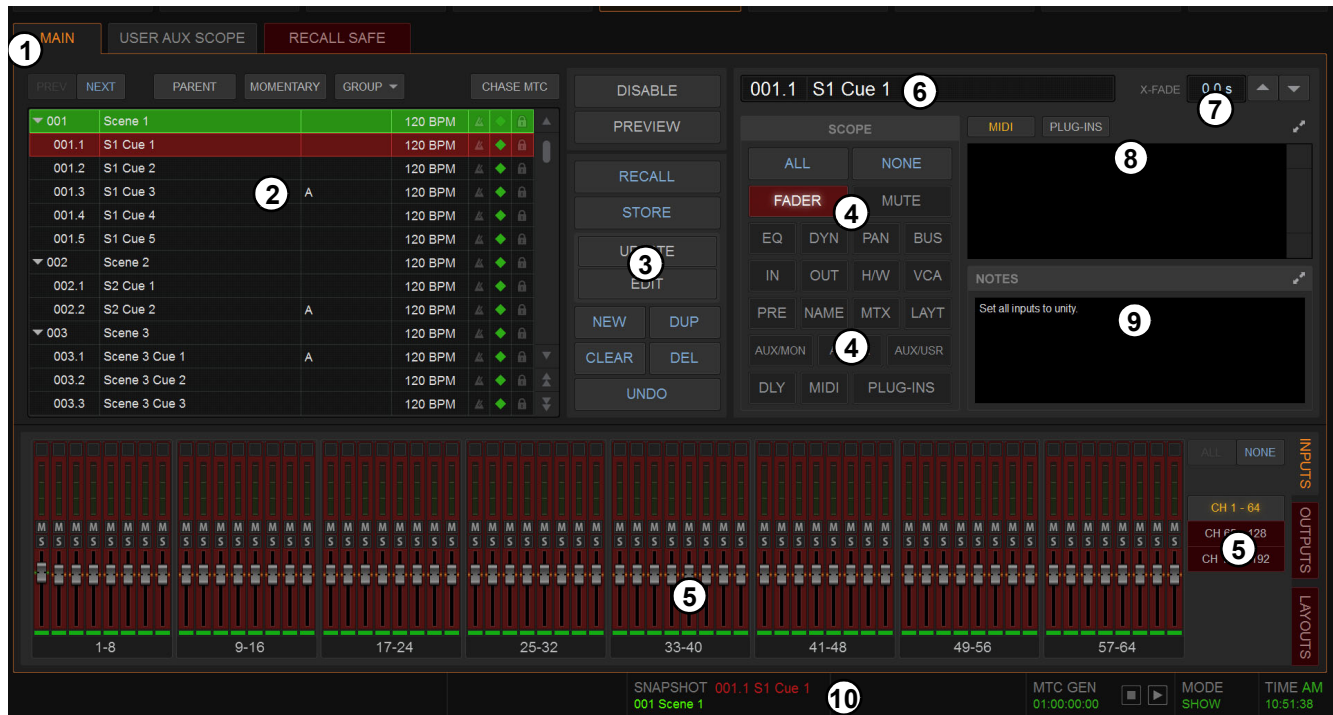

- 1 – Main, User Aux Scope, and Recall Safe Tabs
- 2 – Snapshots List
- 3 – Snapshot Command Buttons
- 4 – Snapshot Scope Controls
- 5 – Channel Scope Controls
- 6 – Currently Targeted Snapshot Display
- 7 – Snapshot Crossfade Controls
- 8 – MIDI/Plug-Ins List
- 9 – Snapshot Notes
- 10 – Snapshot Status Display

Main, User Aux Scope, and Recall Safe Tabs

The Snapshots page provides Main, User Aux Scope, and Recall Safe tabs.

Main Provides the primary snapshot controls.

User Aux Provides a matrix of Auxes that can be scoped individually per input channel. See [User Aux Scope](#).

Recall Safe Provides a matrix of channel parameters that can be globally safed (or isolated) from Recall for all snapshots. See [Recall Safe](#).

Snapshots List

Snapshots can be targeted, renamed, recalled, previewed, edited, locked, reordered, duplicated, searched, and deleted from the Snapshots list. You can also designate snapshot hierarchy (Parent/Child snapshots), create Momentary snapshots, and create snapshot Groups. Icons are provided showing the status of various snapshot attributes.

Snapshot Entries

By default, each item in the Snapshots list has a number (001–999) and name. Numbering will be different for Parent/Child snapshots, and Momentary snapshots, as follows:

- Child snapshots are automatically numbered corresponding to their Parent snapshot, with a decimal number (such as .1, and .2). For example, for a Parent snapshot 001, its first associated Child snapshot is numbered 001.1.
- Momentary snapshots do not have a number.

Snapshot Entry Status Indication

Snapshot entries in the Snapshots list are highlighted in the following colors to indicate their statuses:

Green Indicates the currently recalled snapshot.

Red Indicates the currently targeted snapshot.

Yellow Indicates that the snapshot is both the currently recalled *and* the currently targeted snapshot.

Blue Indicates that the snapshot is part of a multi-selection but not the last recalled or currently targeted snapshot.

Snapshot Attribute Icons

To the right of each snapshot number and name are icons indicating the status of the available snapshot attributes. Icons can be shown or hidden. The following attributes have icons:

- Each snapshot provides a MIDI icon that lights if MIDI messages are included in the snapshot (See [Adding MIDI Data to Snapshots](#).)
- If either the MIDI Read or Generate feature is enabled, each snapshot shows a time code value, trigger indicator, or send indicator. (See [Snapshot Time Code Display](#).)
- If system Tempo has been enabled in Options > Misc, Tempo data can be shown for each snapshot instead of MIDI. Each snapshot shows an associated tempo, along with a Tempo On/Off toggle icon. (See [Adding Tempo Data to Snapshots](#).)



Both MIDI and Tempo are available parameters at all times. However, the Snapshots list can only display one or the other at a time.

- On systems connected to a compatible Pro Tools system with VENUE Link enabled, a snapshot can be configured to create a Marker in the Pro Tools recording when that snapshot is recalled. The diamond-shaped Markers icon toggles this feature on/off for each snapshot. (For more information, see the *S6L Live Recording Guide.pdf*.)
- Each snapshot provides a Lock icon that toggles the snapshot between Locked (write-protected) and Unlocked. See [Locking Snapshots](#).

To show or hide snapshot attribute icons:

- Touch-and-hold any snapshot in the Snapshot list and select **Show** or **Hide** any of available attributes.

When snapshots are assigned to a Snapshot Group, the letter of the assigned Groups is also shown in the list. Group assignment is always displayed and cannot be hidden.

Recall Buttons (Prev and Next)

The Recall Previous (–) and Recall Next (+) buttons at the top of the Snapshots list cause the previous or next snapshot in the list to be targeted and recalled in one step.

Parent / Child

Designates one or more items as Parent or Child snapshots. See [Hierarchical Snapshots \(Parent and Child Snapshots\)](#).

Momentary / Sequential

Designates one or more items as Momentary snapshots. See [Momentary Snapshots](#).

Group

Assigns or unassigns one or more selected snapshots to Snapshot Groups. See [Snapshot Groups](#).

Chase MTC/LTC

Enables or suspends automated recall of snapshots when either the MTC/LTC Read or MTC Generate option is enabled.

Snapshot Keyboard Shortcuts

When the Snapshots page is displayed, you can perform the following snapshot functions with these keyboard shortcuts:

Snapshot Function	Keyboard Shortcut
Target Next/Previous Snapshot	Up/Down Arrow keys
Target First Snapshot in List	Home key
Target Last Snapshot in List	End key
Target Snapshot at Top of Page	Page Up
Target Snapshot at Bottom of Page	Page Down
Select Multiple Consecutive Snapshots	Shift-select snapshots
Select Multiple Non-Consecutive Snapshots/Deselect any Snapshot	Ctrl-select snapshots
Select All Snapshots	Ctrl + A
Create New Snapshot	Ctrl + N
Recall Targeted Snapshot	Ctrl + R
Store Targeted Snapshot	Ctrl + S
Undo	Ctrl + U
Add or update MIDI/Plug-in data to snapshot	Touch-and-hold MIDI/Plug-ins entry

Selecting Snapshots

You can select single snapshots or multiple snapshots in order to target, recall, duplicate, edit, lock, designate, group, or delete them in the snapshots list.

To select multiple consecutive snapshots:

- Hold the Shift key and select the snapshot names in the Snapshots list.

To clear a selection of multiple consecutive snapshots:

- Select any snapshot name in the Snapshots list.
 - or –
- Rotate the encoder in the Snapshots section of the MLM.

To select or de-select non-consecutive snapshots:

- Hold the Ctrl key and select the snapshot names in the Snapshots list.

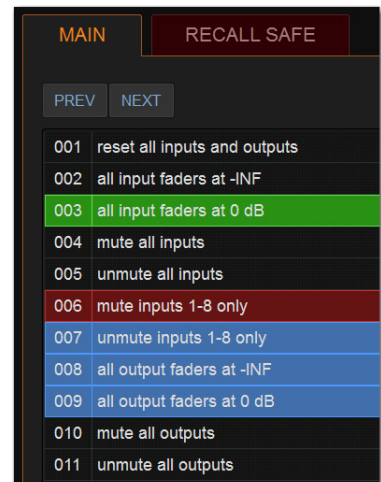

Multiple items selected in the Snapshots list

Snapshot Type Text Search

Type Text search lets you use the keyboard for fast navigation of the Snapshots list.

To search for and target a snapshot:

- 1 Go to the Snapshots page.
- 2 Type the number of the snapshot, or type the first letters of the snapshot name.
- 3 Press the Tab key on your keyboard to cycle through any snapshots that start with the same letter.

Centering the Snapshot List

The Options > Snapshots page provides a preference setting to always center the Snapshot list on the last recalled snapshot. This setting lets you always view the snapshots immediately above and below (prior to and following) the last recalled snapshot. This setting only affects the scroll position of items in the Snapshot list.

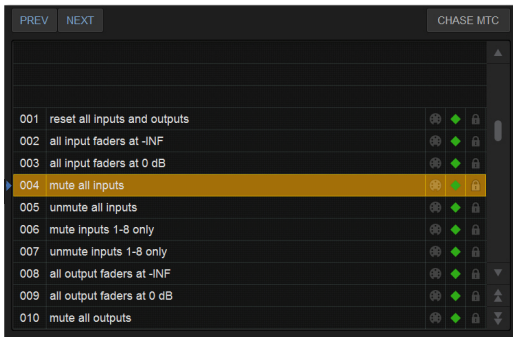

Snapshot list with Center Last Recalled Snapshot enabled

To center the Snapshot list on the last recalled snapshot:

- In the Snapshots General Preferences section of the Options > Snapshots page, select Center Last Recalled Snapshot. In the Snapshot list, a blue pointer appears to the left of the center position. If a Momentary snapshot recalled, it is centered in the list, but pressing Previous or Next recalls the snapshot above or below the previously recalled snapshot, respectively, not the previous or next Momentary snapshot (if any). For more information, see [Momentary Snapshots](#).

Snapshot Command Buttons

Disable Temporarily disables all snapshot functions.

Preview An “offline” mode in which the system continues to process audio using its settings at the time Preview is invoked, letting you recall, edit and manage snapshots without affecting the current mix.

Recall Recalls the targeted snapshot, updating the system to reflect the status of all scoped data types and channels in the snapshot (subject to the current Recall Safe settings). If the setting Confirm Snapshot Recall is enabled in the Options > Snapshots page, a confirmation dialog appears requiring you to confirm that you want to recall the snapshot.

Store Stores the current state of the system in the targeted snapshot for all data types and channels, overwriting any existing data in the snapshot.

Update Lets you apply isolated changes to one or more snapshots at once (such as updating a channel EQ across all snapshots).

Edit Enables Edit mode. Lets you adjust parameters freely and apply those changes to one or more snapshots. Changes can be applied in Absolute or Relative fashion.

Undo Returns the system to its state before the last snapshot command.

New Creates a new snapshot that captures the current state of all data types and channels.

Duplicate Creates a copy of the selected snapshots.

Clear Clears the contents of the targeted snapshot, but retains any associated MTC information.

Delete Deletes the targeted snapshots.

Snapshot Scope Controls

When you create a snapshot, it captures the current state of *all* system settings. However, you can select which of these settings you want to be recalled when you recall a particular snapshot.

The selection of data types and channels that are recalled when you recall a snapshot is referred to as the *scope* of a snapshot. The Snapshot Data Type buttons and on-screen faders determine (and display) the data types are recalled for which channels.

The Recall Safe tab provides global control of automation safe status for parameters on individual channels. The User Aux Scope tab lets you specify scope for individual Auxes on a per-Input channel basis.

Scope States

Scoped Red display indicates that the data type or channel is currently scoped and will be affected by snapshot recall.

Not Scoped Gray display indicates that the data type or channel is not currently scoped and will not be affected by snapshot recall.

Data Type Scope Buttons

The Snapshot Data Type Scope buttons display scope status for the corresponding types of controls on the control surface. See Table 5 on page 261 for a complete list.

Data Type Scope Action Buttons

All Turns on the scope for all data types at once. This is equivalent to selecting all of the Data Type buttons so they are lit red.

None Turns off the scope for all data types at once. This is equivalent to deselecting all of the Data Type buttons so they are unlit.

 For a list of parameters associated with each Data Type, see [Snapshot Data Types and Parameters](#).

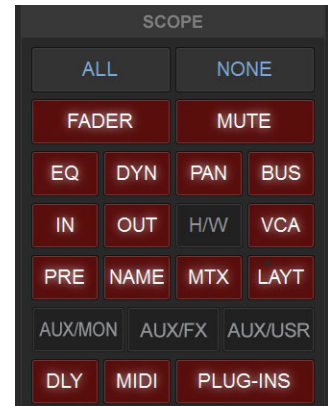

Channel Scope Controls

Channels are included or excluded from snapshots by selecting them on-screen in the Snapshot Channel Faders display. The Snapshot faders display the scope status of each channel, along with indication of the fader positions and mute states that will result by recalling the targeted snapshot.

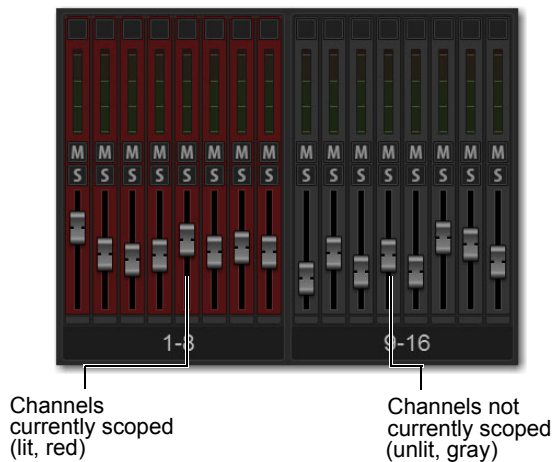

Snapshot channel fader display showing different scope states

By default, you cannot adjust fader position, Solo, Mute, and Safe status directly from the Channel Scope controls. You can choose to enable this ability by enabling the [Enable Strip Control on Snapshots Tab](#) setting.

Channel Fader Position

When you target a snapshot with scoped channels that have different fader positions from the current fader positions, the target fader positions are shown in bright red.

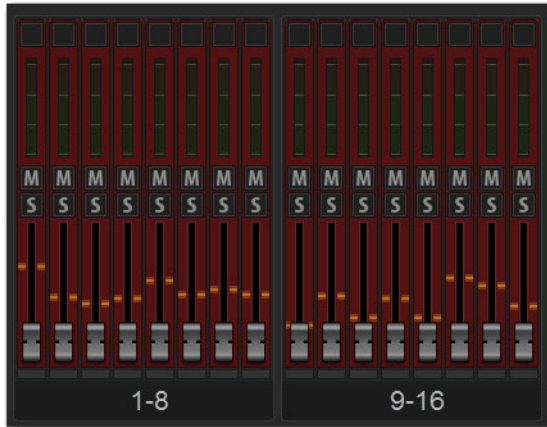

Snapshot channel fader display showing target fader positions

Channel Mute State

When you target a snapshot with scoped channels that have different mute states from the current mute states, the target mute buttons are outlined in yellow.

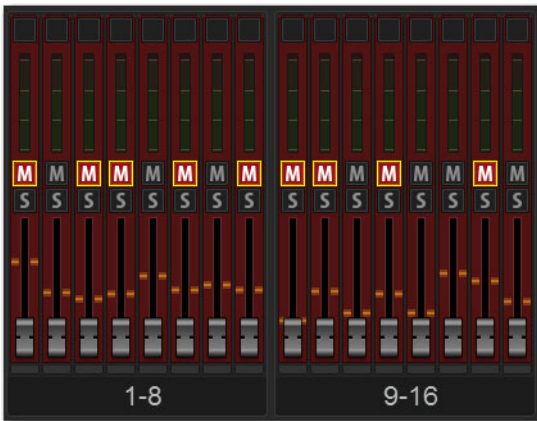

Snapshot channel fader display showing target mute states

 Though the currently selected channel is displayed in the Snapshots page, keep in mind that you cannot target a different channel from this page. The currently selected (target) channel is indicated for visual reference only. To select and target a different channel, use the channel Select switches or the Channel Scroll buttons.

Channel Scope Action Buttons

All Turns on the scope for all channels displayed on the current tab (such as 1–64). Double-tapping the All button turns on the scope for all channels on the system.

None Selecting the None button turns off the scope for all channels on the current page. Double-tapping the None button turns off the scope for all channels on the system.

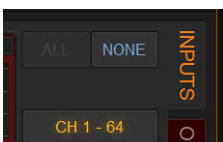

Channel Scope Action Buttons

Snapshot Status Display

The Snapshot Status display shows the numbers and abbreviated names of the currently targeted snapshot (in red text) above the currently recalled snapshot (in green or yellow). Recalling the targeted snapshot makes it the currently recalled snapshot.

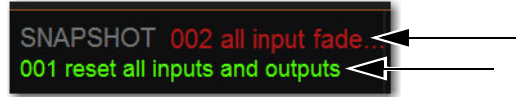

Next Snapshot (top) and Last Recalled snapshot (bottom) in the Status area

Creating Snapshots

Snapshots can be created at any time to store the current channel and parameter settings. You can create new snapshots manually in the Snapshots page, or by duplicating existing snapshots to build your mix as you work.



Use the first snapshot in a Show file to establish the basic settings for a performance. For subsequent snapshots, use the scope controls, User Aux Scope, and Recall Safe settings to selectively recall only those controls that need to change between sections or songs, leaving other controls unaffected by snapshot recall.

Creating New Snapshots

When you create a snapshot, it captures the current state of all system settings. When recalling a snapshot, you can selectively recall parameters using the snapshot scope controls.

To create a new snapshot:

- 1 Set parameters as you want them to be stored in the snapshot.
- 2 Select **New**. The new snapshot appears in the Snapshots list.



You can undo the New snapshot command at any time by pressing the Undo Snapshot Command button.



When you create a new snapshot it automatically inherits the channel and data type scope of the currently targeted snapshot.

Naming Snapshots

New snapshots are automatically numbered and appear as “<Untitled>” in the Snapshots list. Snapshots can be renamed at any time. You can undo snapshot naming operations.

To name a snapshot:

- 1 Do one of the following:
 - Double-tap the snapshot name in the Snapshots list or the current target name display.
 - Touch-and-hold the snapshot name and choose **Rename**.
- 2 Type a name for the snapshot.
- 3 Press Enter on the keyboard or select another snapshot name.

Adding Notes to Snapshots

You can add notes to snapshots at any time. You do not need to store the snapshot to save the notes in the snapshot.

To add or edit comments for a snapshot:

- 1 Double-select the Notes header or select the Expand icon to expand the Notes field.
- 2 Double-select in the Notes field and enter text.



MIDI and plug-in data is not captured when a snapshot is created. This data is added to existing snapshots directly from the MIDI/Plug-Ins lists. See [Adding MIDI and Plug-In Data to Snapshots](#).

Hierarchical Snapshots (Parent and Child Snapshots)

The Snapshots List lets you organize snapshots into a two-level hierarchy consisting of *Parent* (primary) and *Child* (secondary) snapshots. The ability to designate Parent and Child snapshots makes it easier to manage multiple snapshots associated with a scene, song, or other segment of a performance.

Up to 99 Child snapshots can be associated with a single Parent snapshot. Child snapshots are automatically numbered corresponding to their Parent snapshot, with a decimal number (such as .1, and .2). For example, for a Parent snapshot 001, its first associated Child snapshot is numbered 001.1. Parent snapshot numbers are unaffected by adding or removing Child snapshots.

Parent	001	Scene 1
Child	> 001.1	Cue 1
Child	> 001.2	Cue 2
Child	> 001.3	Cue 3
Child	> 001.4	Cue 4
Child	> 001.5	Cue 5
Parent	002	Scene 2
Child	> 002.1	Cue 2.2
Child	> 002.2	Cue 2.3

You can optimize how hierarchical snapshots are displayed in the list by [Collapsing and Expanding Parent/Child Views](#). The Snapshot List also provides tools for [Managing and Editing Hierarchical Snapshots](#).

Designating Snapshots as Parent or Child

You can designate snapshots as Parent or Child snapshots in the following ways:

- By selecting one or more snapshots and using the Parent/Child button on-screen in the Snapshots tab
- Using drag and drop in the Snapshots list
- By editing the Snapshot Number

To designate snapshots as Parent or Child snapshots in the Snapshot List:

1 Click to select one or more snapshots in the list.

Above the Snapshot List, the Parent/Child button displays Child or Parent depending on what is selected in the Snapshots List:

- When one or more unaffiliated or Parent snapshots are selected, the button becomes Child.
- When one or more Child snapshots are selected, the button becomes Parent.
- When both Parent and Child snapshots are selected, or if no snapshots are selected, the button is unavailable.

PREV	NEXT	CHILD	MOMENTARY	GROUP	CHASE MTC
001	Scene 1			120 BPM	⚙️ 🔒
002	S1 Cue 1			120 BPM	⚙️ 🔒
003	S1 Cue 2			120 BPM	⚙️ 🔒
004	S1 Cue 3			120 BPM	⚙️ 🔒
005	S1 Cue 4			120 BPM	⚙️ 🔒
006	S1 Cue 5			120 BPM	⚙️ 🔒
007	Scene 2			120 BPM	⚙️ 🔒

Multiple unaffiliated snapshots 002–006 selected in the Snapshot List

2 Click the Parent/Child button on-screen, as appropriate for the selected snapshot.

The selected snapshots are designated as Parent or Child. Parent snapshots show an Expand/Collapse icon next to their number.

PREV	NEXT	PARENT	MOMENTARY	GROUP	CHASE MTC
▼ 001	Scene 1			120 BPM	⚙️ 🔒
001.1	S1 Cue 1			120 BPM	⚙️ 🔒
001.2	S1 Cue 2			120 BPM	⚙️ 🔒
001.3	S1 Cue 3			120 BPM	⚙️ 🔒
001.4	S1 Cue 4			120 BPM	⚙️ 🔒
001.5	S1 Cue 5			120 BPM	⚙️ 🔒
002	Scene 2			120 BPM	⚙️ 🔒

Child snapshots 001.1–001.5 associated with a Parent snapshot 001

To designate a snapshot as a Child snapshot using drag and drop:

- 1 Make sure there is at least one Parent snapshot in the list, with at least one Child snapshot associated with it.
- 2 In the Snapshot list, drag the desired snapshot onto a Parent snapshot (indicated by the destination Parent becoming outlined in white), then drop the new snapshot.



▼ 022	PCh 1		120 BPM	▲	◆	🔒
022.1	PCh 6		120 BPM	▲	◆	🔒
022.2	PCh 2		120 BPM	▲	◆	🔒
023	PCh 3		120 BPM	▲	◆	🔒
024	PCh 4		120 BPM	▲	◆	🔒
025	PCh 5		120 BPM	▲	◆	🔒

Designating a Child snapshot by dragging and dropping a snapshot (025) onto a Parent (022)

The snapshot is moved, designated as a Child snapshot, and renumbered. While using drag and drop, the following rules apply:

- Dropping a Parent snapshot onto an existing Parent designates it as a Child snapshot. If the moved Parent has any associated Child snapshots, the moved Parent and all its associated Child snapshots are moved and renumbered.
- You cannot drop a Child snapshot onto an existing Child snapshot.
- When a Child snapshot is dragged and dropped outside of its Parent, it becomes a standard (unaffiliated) snapshot.

Snapshots can also be designated as Parent or Child by editing their Snapshot number.

To designate Parent or Child snapshots by editing Snapshot number:

- 1 Double-click the displayed Snapshot number (such as 001).
- 2 To designate a Child snapshot, enter a number-decimal-number (such as 15.1) and press Enter.
 - If the first numbers correspond to an existing Parent snapshot, the edited snapshot becomes a Child associated with that Parent. For example, if there is a Parent snapshot numbered 015 and you edit a different snapshot number to 15.1, that edited snapshot becomes a Child (015.1) to the Parent 015.
 - If that same Parent snapshot (015) has two Child snapshots 015.1 and 015.2, editing an unaffiliated snapshot number (such as 018) to become 15.2 places the edited snapshot as the second Child, and renumbers the previously numbered 015.2 snapshot to 015.3. Any other higher numbered Child snapshots are similarly incremented.
 - If the edited snapshot number is higher than any existing Parent snapshot, the edited snapshot becomes a Child of the highest numbered Parent in the list. For example, if there are five Parent snapshots 001–005, editing the Snapshot number of one snapshot to become 8.1 results in the edited snapshot becoming snapshot 005.1 (a Child of the highest numbered Parent, 005).

Collapsing and Expanding Parent/Child Views

Parent/Child snapshot views can be expanded or collapsed in the Snapshot List. When expanded, all Child snapshots associated with a Parent are displayed in the list. When collapsed, only the Parent snapshot is displayed.

Collapsing Snapshot families make the Snapshots List easier to manage when selecting and rearranging snapshots, such as when reordering a song, song list, or scenes for a performance.

Views can be expanded and collapsed manually, and will auto-expand/collapse when moving, designating, and recalling snapshots.

Manually Collapsing and Expanding Parent/Child Views

To collapse or expand a Parent and its associated Child snapshots:

- 1 Select a Parent in the Snapshot List.
- 2 Tap to toggle the Expand/Collapse icon to the left of the Snapshot number.

Snapshot ID	Name	BPM
▼ 001	Scene 1	120 BPM
001.1	S1 Cue 1	120 BPM
001.2	S1 Cue 2	120 BPM
001.3	S1 Cue 3	120 BPM
001.4	S1 Cue 4	120 BPM
001.5	S1 Cue 5	120 BPM
▼ 002	Scene 2	120 BPM
002.1	S2 Cue 1	120 BPM
002.2	S2 Cue 2	120 BPM
▼ 003	Scene 3	120 BPM
003.1	Scene 3 Cue 1	120 BPM

Snapshot ID	Name	BPM
▶ 001	Scene 1	120 BPM
▼ 002	Scene 2	120 BPM
002.1	S2 Cue 1	120 BPM
002.2	S2 Cue 2	120 BPM
▼ 003	Scene 3	120 BPM
003.1	Scene 3 Cue 1	120 BPM
003.2	Scene 3 Cue 2	120 BPM
003.3	Scene 3 Cue 3	120 BPM

Expand/Collapse icon shown when expanded (at left) and collapsed (at right)

Automatic Collapse and Expand

Parent/Child views automatically expand or collapse when the following occur:

- Collapsed snapshot views automatically expand when a collapsed Child snapshot is recalled, and whenever a Child snapshot is added to or removed from that family of snapshots.
- Recalling a Child snapshot associated with a different Parent automatically collapses the auto-expanded snapshot view (the Parent of the newly recalled Child is automatically expanded).
- Collapsed Parent snapshots are highlighted whenever any associated Child snapshot is selected.
- When a Child snapshot in an expanded view is selected, collapsing that view deselects the Child. If the previously selected Child was also the Targeted snapshot when the view was collapsed, its Parent becomes Targeted and selected.

Managing and Editing Hierarchical Snapshots

You can rearrange, update, edit, delete, and duplicate hierarchical snapshots similar to standard snapshots but with additional capabilities and choices to simplify list management tasks.

Rearranging Parent and Child Snapshots

Rearranging Parent snapshots in the list automatically updates their snapshot numbers just like standard snapshots. All associated Child snapshots move with the Parent, and Child snapshot numbers are also updated. For example, moving a Parent snapshot 001 so it becomes the second Parent rennumbers that Parent to 002, and its Child snapshots are renumbered 002.1, 002.2 and so on.

Child snapshots can be rearranged by dragging them up or down among other Child snapshots associated with the same Parent, and their numbering is automatically updated. Child snapshots can be renamed just like standard snapshots.

When rearranging Parent or Child snapshots, views automatically expand or collapse (see [Automatic Collapse and Expand](#)).

Editing Parent and Child Snapshots

When updating, storing, deleting, or duplicating a Parent snapshot you can choose whether to update the selected snapshot only (Selected Only), or to apply the change to all associated (Child) snapshots (All).

Momentary Snapshots

You can designate one or more snapshots as *Momentary* snapshots. Momentary snapshots are non-sequential, and have no associated snapshot number. Recalling Momentary snapshots does not change the Currently Recalled or Targeted state of the list.

Use Momentary snapshots for any situation in which you need to recall one or more parameters without losing your current place in the Snapshot List. For example, if a vocal mic goes out during a performance you can recall a Momentary snapshot that only changes the patching for the vocal channel to the input of a spare/backup mic. The Snapshot List remains unchanged.

Creating Momentary Snapshots

To create a Momentary snapshot:

- 1 Create a new snapshot, or select an existing Parent snapshot in the list (Child snapshots cannot become Momentary snapshots).
- 2 Tap the Momentary button above the Snapshot List.

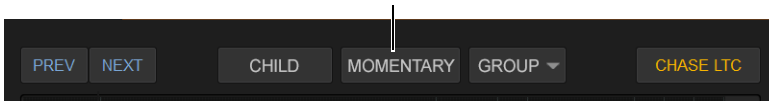

Momentary button

The snapshot is moved to the end of the Snapshot list, and is not numbered. To convert the Momentary snapshot back to a standard snapshot, select the Momentary snapshot (the Momentary button becomes Sequential) and tap the Sequential button.

A screenshot of a Snapshot List table. The first two rows are numbered: 026 Scene 26 and 027 End. The last two rows are Momentary snapshots: Momentary example 1 and Momentary example 2. A white bracket on the left side groups the two Momentary snapshots together.

▶ 026	Scene 26		120 BPM	▲	◆	🔒
027	End		120 BPM	▲	◆	🔒
	Momentary example 1		120 BPM	▲	◆	🔒
	Momentary example 2		120 BPM	▲	◆	🔒

Momentary snapshots in the list

Recalling Momentary Snapshots

Momentary snapshots can be recalled manually by selecting them in the Snapshot List.

To recall a Momentary snapshot manually in the Snapshot list:

- Select and recall the snapshot just as you would for a standard snapshot:
 - Scroll the list or use Type Text Search to select the desired snapshot.
 - Press Recall.
 - Define an Event that recalls the snapshot.

In the Snapshot List the recalled Momentary snapshot lights red, and the previously recalled snapshot lights green. If the Center Last Recalled Snapshot option is enabled in Options > Snapshots, the Momentary snapshot is centered in the list. Pressing Previous or Next recalls the snapshot above or below the previously recalled snapshot in the list, respectively.

 *Momentary snapshots can also be recalled via time code.*

Editing Momentary Snapshots

Momentary Snapshots can be selected, renamed, Stored, Updated, and Edited just like standard snapshots. In addition:

- Momentary snapshots can be reordered in the list by dragging and dropping them between other Momentary snapshots.
- Moving a Momentary snapshot and dropping it between standard snapshots converts it into a standard (sequential) snapshot with an appropriate snapshot number.
- Moving a Momentary snapshot onto an existing Parent or between Child snapshots converts it into a Child snapshot with an appropriate snapshot number.

Momentary Snapshots do not support Parent or Child designation, but can be assigned to [Snapshot Groups](#).

Snapshot Groups

You can organize snapshots into Snapshot Groups, to be able to quickly update multiple snapshots simultaneously. A Snapshot Group can contain one or more snapshots, and snapshots can be assigned to multiple groups.

For example, in a theatrical production you might want to create a Snapshot Group for all cues that include a specific character, and another group for when that character is wearing a hat or a mask. If you decide you want to use a different EQ setting on a character mic, you can adjust the EQ in one of the corresponding snapshots. When you Store the change (to update the single snapshot) you can choose to apply the change to all other snapshots in the group (without having to manually select the other snapshots).

Or in a music performance, you might create a Snapshot Group for all songs where the drummer sings lead. By grouping all the snapshots for songs when the drummer sings you can increase the level of the lead vocal in one of those snapshots, then choose to apply the level increase to all snapshots in the same Snapshot Group.

Assigning Snapshots to Groups

To assign snapshots to a snapshot group:

- 1 Select one or more snapshots in the list, and make sure none of them are locked (you cannot assign locked snapshots to a Snapshot Group).
- 2 Tap the Group selector located just above the list.
The Group selector shows a hierarchical menu. Each top-level choice (Groups A–Z >, Groups AA–ZZ >, Groups BA–BZ > and so on) provides its own sub-menu of choices (Group: A–Z, Group: AB–AZ, Group: BA–BZ, and so on).
- 3 Choose a Group to which you want to assign the currently selected snapshots.
The chosen Group (such as A) appears in the list for the selected snapshot(s). (The location of the Group indicator varies depending on the display status of other snapshot attributes such as time code or markers.)



Snapshot List showing three snapshots assigned to Group A

To remove a group assignment:

- 1 Select the snapshot(s) you want removed from the group.
- 2 Tap the Group selector and deselect the group from the appropriate sub-menu.

Editing Grouped Snapshots

When you Store, Update, or Edit a snapshot that is assigned to a Snapshot Group you can choose to apply the edit(s) to only the selected snapshot (Selected Only) or to all other snapshots in the same Snapshot Group(s) (All).

Recalling Snapshots

To recall a snapshot, you target the snapshot, scope channels and parameters that are recalled when you recall the snapshot, then recall the snapshot.

 You can also target and recall snapshots using the [Snapshot Controls](#) on the MLM.

Targeting Snapshots

Targeting a snapshot lets you preview which data types and channels will be affected by that snapshot before recalling it. When a snapshot is targeted, the on-screen Data Type buttons and Channel Faders update to show the data types and channels enabled for recall by the snapshot.

 *Preview mode lets you take the system controls offline to recall and edit snapshots without affecting the current mix. See [Preview Mode](#).*

To target a snapshot, do any of the following:

- Rotate the encoder in the Snapshots section of the MLM so the targeted snapshot is shown in the Snapshot display.



Snapshots section of the MLM

- On the Snapshot page of the external screen, select the snapshot name in the Snapshot list.
- Type the number or name of the snapshot on the keyboard.
- Press the Home/End, Page Up/Page Down, and Up/Down Arrow keys on the keyboard to navigate the Snapshot list.

The targeted snapshot is shown in the Snapshot display on the MLM, highlighted in red in the external screen Snapshots list, and shown in red in the external screen Status display.

Scoping Channels and Parameters

When you create a snapshot, it captures the current state of all system settings. When recalling a snapshot, you can scope the channels you want affected (using the Channel Scope controls), and the parameters that are recalled (using the Data Type Scope buttons).

 You can rescope snapshot data at any time. You do not need to store/overwrite a snapshot if you change the scope of a snapshot.

To scope channels for recall:

- 1 On the Snapshots page of the external screen, select the individual fader strips so that they are displayed in red.
- 2 To select channels in banks of eight, select the channel numbers at the bottom of the on-screen fader strips so the channels.

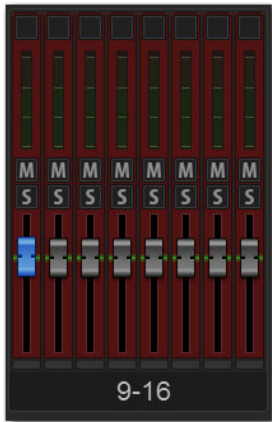

A bank of eight channels scoped for snapshot recall

- 3 To select all channels, select the ALL Channel Scope Action button.
- 4 To clear all channels from the scope, select the NONE Channel Scope Action button.

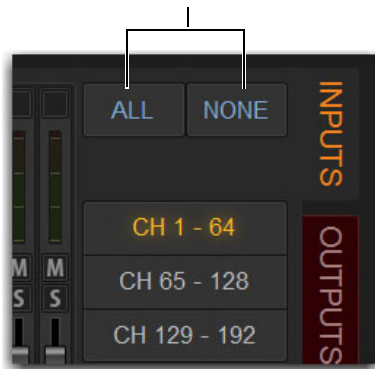

ALL and NONE Channel Scope Action buttons

- 5 The fader strips for scoped channels are highlighted in red.

To scope parameters for recall:

- 1 For each parameter of the scoped channels you want affected when the snapshot is later recalled, select the corresponding Data Type button so that it is scoped (displayed in red).

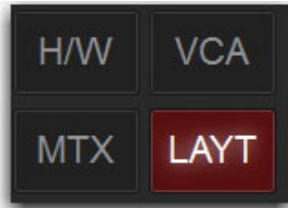

Layouts included in the scope of a snapshot

- 2 To scope all parameters, select the ALL button.
- 3 To clear all data types from the scope, select the NONE button.

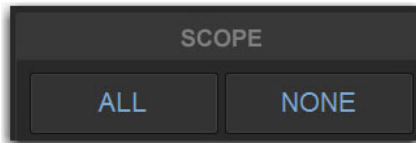

ALL/NONE Data Type Scope buttons

 *When you create a new snapshot it automatically inherits the channel and data type scope of the currently targeted snapshot.*

Recalling Snapshots

You can do the following when recalling snapshots:

- Target and instantly recall successive snapshots (next or previous)
- Target first, then recall one or more snapshots
- Select multiple snapshots and recall them all sequentially
- Target snapshots, change Data Type or Channel Scope settings, then recall.

 *Undoing snapshot recall commands might cause audio to be interrupted. Use Undo with caution in performance.*

Confirm Snapshot Recall

When the **Confirm Snapshot Recall** setting is enabled in the Options > Snapshots tab, a warning dialog appears asking to confirm the operation.

Recalling Successive Snapshots Instantly

You can instantly recall successive snapshots in the Snapshots list using the S6L control surface or the external screen. This command references the currently recalled snapshot, not the targeted snapshot.

To instantly recall successive snapshots using the control surface:

- On the MLM, press the PREV or NEXT switch, under the Right Soft Keys. The switches are lit when a next and/or previous snapshot is available to recall.



Prev/Next Snapshot switches

To instantly recall successive snapshots on the external screen:

- Select the PREV or NEXT button at the top of the Snapshots list.

⚠ The Snapshot Recall buttons combine target and recall actions in one step, causing the previous or next snapshot to be instantly active. These buttons cannot be used to preview snapshots before recalling them.

Targeting Before Recalling Snapshots

You can target then recall a snapshot using the S6L control surface or the external screen.

To target and then recall a snapshot using the control surface:

- Rotate the encoder in the Snapshots section of the MLM so the targeted snapshot is shown in the Snapshot display.
- (Optional) Set the scope of the snapshot.



Snapshots section of the MLM

- Press the lit **Recall** switch.

To target and then recall a snapshot using the external screen:

- Select the snapshot name in the Snapshot list.
- (Optional) Set the scope of the snapshot.
- Select the Recall button on-screen.

💡 Snapshot Recall can also be triggered by a footswitch or any number of other functions using events. For more information, see [Events](#).

Managing Snapshots

You can manage snapshots in the list by storing, locking, clearing, duplicating, deleting, or moving them. When any of these actions are performed while multiple snapshots are selected, on a Parent snapshot, or on a snapshot that is a member of a Snapshot Group, you can choose to apply the action to only the selected snapshot or all related snapshots.

Storing Snapshots

You can modify the contents of an existing snapshot, overwriting it with new settings, using the *Store* command. It is not necessary to recall a snapshot to store it. You can undo Store commands.

To store the current state of the system in an existing snapshot:

- 1 Set all parameters as you want them to be stored in the snapshot.
- 2 Select the snapshot in the Snapshot list.
- 3 Select the Store button on-screen.
- 4 Set the scope by doing the following:
 - For each parameter you want to be affected when the snapshot is recalled, select the corresponding **Data Type** button so that it is scoped (displayed in red).
 - For each channel you want affected when the snapshot is recalled, select its on-screen channel fader so that it is scoped (displayed in red).

Locking Snapshots

Snapshots can be *locked* to prevent them from being accidentally altered, overwritten or deleted. Locked snapshots can be selected, recalled, moved and duplicated. They cannot be overwritten, renamed, rescoped or otherwise changed. New and duplicated snapshots default to unlocked. Lock status can be changed at any time, including while in Preview mode.

To lock a snapshot:

- 1 Go to the Snapshots page and select the Main tab.
- 2 In the Snapshot list, select the padlock icon at the far right of the row for any item. The padlock icon illuminates to indicate the snapshot is now locked.

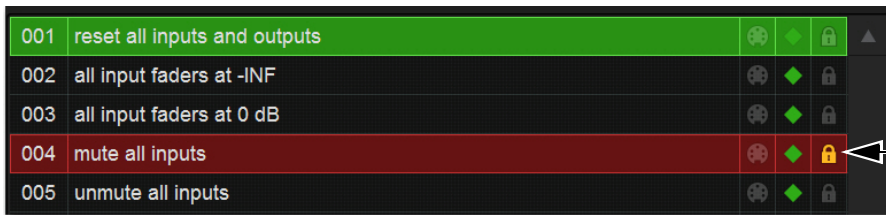

Snapshot lock controls

- 3 Select multiple snapshots using **Multi-Select** or the Shift key to lock or unlock multiple snapshots at once.

Once locked, operations that would otherwise affect the snapshot cause the Status display and channel LCDs and Snapshot LCD to temporarily show a message reminding you that the operation cannot be applied while the snapshot is locked.

To unlock a snapshot:

- Select the lit padlock icon in the row for that snapshot.

Undo and Locked Snapshots

You can undo locking or unlocking a snapshot. When toggling lock status for a selection of more than one snapshot, the entire operation creates a single undo point (it does not track and provide undo for each individual snapshot in the selection).

⚠️ *Undo can revert snapshots to “unlocked” status. For example, if you change the scope of an unlocked snapshot, lock the snapshot and then use Undo, the snapshot is unlocked. Pressing Undo one more time will revert the snapshot to its original scope.*

Locking Snapshots and MIDI Record

When using the MIDI Record feature, all MIDI data captured up to the point a snapshot is locked is preserved. If the MIDI Record operation is still active at the time the snapshot is locked, record mode is exited, the REC button becomes unavailable for that snapshot, and subsequent incoming MIDI messages are not captured.

Available Operations with Locked Snapshots

The following table details which operations can or can not be performed on a locked snapshot.

Operation	Allowed while Locked	Disallowed while locked
Select/target snapshot	X	
Recall snapshot	X	
Duplicate snapshot	X	
Re-sequence in snapshot list by:		
• Dragging in snapshot list	X	
• Manually editing sequence number	X	
• Re-sorting by time code	X	
Overwrite (Store to locked snapshot)		X
Update changes		X
Parent/Child (designate)	X	
Momentary/Sequential (designate)	X	
Group (assign or unassign)		X
Apply Edit mode changes		X
Clear		X
Delete		X
Modify Scope		X
Modify User Aux Scope		X
Add/Modify stored MIDI data		X
Add/Modify stored Plug-In data		X
Add/Modify stored Media data		X
Modify Notes		X
Modify X-Fade time		X
Modify Snapshot Name		X
Modify Time Code Location		X
Toggle Time Code Enable		X
Undo changes	X	

Clearing Snapshots

The contents of a snapshot can be cleared while keeping the snapshot in the Snapshot list and retaining its MTC information. This lets you maintain a placeholder that you can use later to store new data. You can undo Clear commands.

To clear the contents of a snapshot:

- 1 Select the snapshots you want to clear.
- 2 Select the Clear Snapshot Command button.
- 3 In the dialog box, select Clear to confirm. Cleared snapshots are renamed “<Untitled>.”

Duplicating Snapshots

Snapshots can be duplicated from the Snapshots list. You can undo Duplicate commands.

To duplicate snapshots:

- 1 Select the snapshots you want to duplicate.
- 2 Do one of the following:
 - Select Dup (Duplicate).
 - or –
 - Touch-and-hold the snapshot name and choose Duplicate.

A copy of each selected snapshot is placed after the selection, with a plus sign (+) appended to the original snapshot name.

If multiple snapshots are selected in the list, the new (duplicate) items are added below their original source snapshots.

Deleting Snapshots

Snapshots can be deleted from the Snapshots list. You can undo Delete commands.

To delete snapshots:

- 1 Select the snapshots you want to delete.
- 2 Do one of the following:
 - Select Del (Delete).
 - or –
 - Touch-and-hold the snapshot name and choose Delete. The snapshots are removed from the Snapshots list, and succeeding snapshots are renumbered.

Moving Snapshots

Existing snapshots can be rearranged in the Snapshots list. When you move one or more snapshots, they are automatically renumbered in the list, but MTC values are left unchanged. You can undo a snapshot move.

To move one or more snapshots:

- 1 Select one or more events in the Snapshots list.
- 2 Touch any selected snapshots and drag them to a new location in the list. As you move items, a white line appears indicating the destination.
- 3 Release your finger to drop the snapshots at the desired location in the list. Snapshots that are moved will be adjacent regardless of their original locations relative to each other (whether adjacent or non-adjacent). Snapshots will be renumbered as necessary according to the new sequence of events.

Importing Snapshots

Snapshots from other Show files can be imported into the currently loaded Show file in the Filing > Load/Save tabs.

For more information, see [Import Snapshots and Events](#).



In VENUE software versions 5.6 and lower, Import Snapshots was available via right-click. Beginning in VENUE software version 5.7, use the Import button instead.

Making Changes to Snapshots

There may be situations where you need to change specific parameters in existing snapshots while leaving other parameters unchanged.

For example, if a guitarist changes instruments in the middle of a tour it might be necessary to change levels and EQ on the guitar channel in all the snapshots in a show. Snapshots provides the following modes to accommodate these types of situations:

Edit Mode Lets you capture individual control changes while you mix, and apply those changes to one or more pre-existing snapshots as absolute or relative changes. For example, you could enter Edit mode the first time a guitarist uses a new guitar in rehearsal. When you are satisfied with your settings you can apply them (in absolute or relative fashion) to update other snapshots. See [Using Edit Mode](#).

Update Mode Lets you update data in pre-existing snapshots after you've already made changes and decided you want to keep them. While Edit mode requires you to know ahead of time that you will be updating snapshots, Update mode lets you decide to update other snapshots with current settings after making adjustments to your mix. For example, if its the third consecutive night you've reached to increase gain on the DI channel for a new guitar, you could use Update mode to quickly take the gain increase you just made and apply it to other snapshots. See [Using Update Mode](#).



Events-driven recall of snapshots is disabled while in Edit or Update mode. For more information, see [Events](#).

Using Edit Mode

Edit mode is a powerful way to update specific parameters across multiple snapshots without overwriting any settings you want to preserve. By entering Edit mode before making adjustments, you can edit a single control or any number of controls, and your changes are tracked from the point Edit mode was entered.



The ability to edit a single control in Edit mode provides more selectivity than Update mode.

Absolute and Relative Edits

Changes can be applied to one or more selected snapshots as *absolute* or *relative* values. Any parameter can be edited in absolute fashion; all dB parameters can be edited in relative fashion.

Examples of Absolute and Relative Edits

Absolute Changing a fader level from 0 dB to -3 dB and applying that change as Absolute results in that fader being set identically to -3 dB in all selected snapshots.

Relative Changing a fader level from 0 to -3 dB and applying that change as Relative results in that fader being reduced by that amount in all selected snapshots, or 3 dB relative to the value previously stored in the snapshot(s). For example, a channel previously at -6 dB would be changed to -9 dB.

Making Relative Changes with Mixed Data Types

If a combination of dB and non-dB parameters (such as gain and EQ frequency) are edited and applied in relative fashion, the dB parameters are adjusted as relative (delta) changes and the non-dB are applied as absolute changes.

To update specific parameters in existing snapshots using Edit mode:

- 1 Go to the Snapshots page and select the Main tab.
- 2 Select the Edit button to enter Edit mode. The Edit button changes into two smaller flashing buttons: Abs, and Rel. The system begins tracking all changes while you make them.

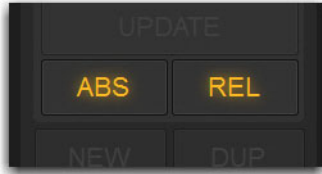

Absolute (ABS) Relative (REL) Edit mode buttons

- 3 Adjust any combination of scopable parameters.
- 4 Select the snapshot(s) to which you want to apply your edits.
- 5 Select either of the flashing buttons Abs (for Absolute) or Rel (for Relative). You can cancel Edit mode by pressing the **Cancel** switch on the control surface, selecting the Cancel button on-screen, or by pressing the ESC key on your computer keyboard.

The selected snapshots are updated according to your changes and your choice of Absolute or Relative edit.

Using Update Mode

You can use the Update command to capture changes and apply them to existing snapshots. Update mode is most useful when you realize during the course of mixing that you want to capture your current settings to use in other snapshots. You can undo Update commands.

To update specific parameters in existing snapshots:

- 1 Make sure the channel is set as needed.
- 2 Select Update. The current data and channel scope is cleared.
- 3 Set the scope to reflect only those parameters you want to update by doing the following:
 - For each parameter you want to update, select the corresponding Data Type button so that it is scoped (displayed in red).
 - and –
 - For each channel you want to update, select the channel so that it is scoped (displayed in red).

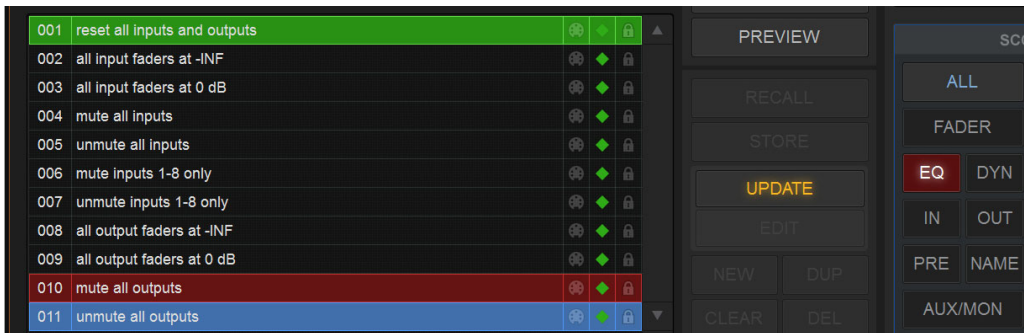

Updating an EQ setting for a channel

- 4 Select the snapshot or range of snapshots you want to update in the Snapshots list.
- 5 Select Update. The scoped parameters are updated in the selected snapshots.

Undoing Snapshot Commands

The Undo function returns the system to the state immediately before the last snapshot command. Undo is multi-level (up to 100), is available while in Preview mode and after performing an Edit or Update mode action.

 *Undoing snapshot recall commands may cause audio to be interrupted. Use Undo with caution in performance.*

To undo a snapshot command:

- Select the Undo button in the Snapshot commands section.

 *If the Undo button is dimmed, Undo is not available.*

Disabling Snapshots

You can temporarily disable the storage and recall of all snapshots. While snapshots are globally disabled, you can target snapshots in the Snapshots list to preview their properties, but you cannot recall them.

To disable all snapshots:

- Select the Disable button in the Snapshot commands section.

Suspend MTC Recall

To disable MTC or LTC recall of individual snapshots in the list:

- 1 Select the green Enable icon in the row for the desired snapshot so that it is unlit.
- 2 Select the Disable/Enable icon again to re-enable the snapshot.

Preview Mode

Preview mode lets you recall, store and edit snapshots without affecting the current mix.

When enabled, Preview mode takes the system offline from the live audio mix so you can “work ahead” during a rehearsal, performance or event to preview upcoming snapshots and edit them as needed. Any control that can be stored and recalled by snapshots is available while in Preview mode, and you can also modify the Snapshot list. Once you are done previewing or editing snapshots, you can store your changes to update the existing snapshots with your changes.

Using Preview Mode

The basic workflow for using Preview mode is as follows:

- 1 Make sure your active mix is set as desired, and make sure the rehearsal, event or performance has an upcoming opportunity for you to go offline.
- 2 Enter Preview mode by selecting the Preview button on the main Snapshots page. The word “PREVIEW” flashes in red across the screen for confirmation, as do all input and output channel strip displays.

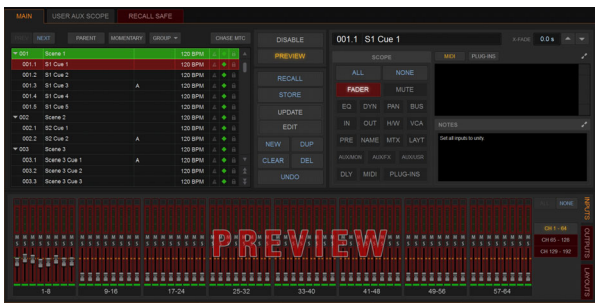

Preview mode

- 3 Do any of the following:

Edit the Snapshots List Reorder snapshots in the list, if desired, by touching-holding-and dragging them. Changes to the order of items in the Snapshots list may affect the current active mix if the affected snapshots rely on MIDI or MTC triggering. (For more information, see [Changing Settings in Preview Mode](#).)

Create a New Snapshot Adjust settings as desired and create a new snapshot by selecting New. (See [Creating New Snapshots](#).)

Recall and Edit an Existing Snapshot Recall a snapshot to preview its settings and make any adjustments necessary, being sure to re-store the snapshot before exiting Preview mode. Storing a snapshot in Preview mode does not affect previously stored MIDI or Plug-in data (if any).

Edit Channel and Scope Settings Edit any channel settings, parameters, or scope associated with the snapshot being previewed. The Snapshots page displays the current snapshot name in italics to indicate that at least one parameter has been changed, and the Channel Faders show you the previous level for each channel in bright red. Scope Data Type buttons and Channel Scope functionality remain live and active at all times (in other words, changes made to these controls while in Preview mode will remain once Preview mode is exited).

Add and Edit MIDI, Plug-In Data To add MIDI, or plug-in data associated with the snapshot, select the Add button in the MIDI or Plug-Ins snapshot list, or select the options in the Media list. For more information, see [Adding Plug-In Data to Snapshots](#).

- 4 To undo an action made while in Preview mode, select the Undo button on-screen. (For more information about Undo in Preview mode, see [Making Changes to Snapshots](#).)
- 5 To update the currently previewed snapshot but remain in Preview mode, press or select Store.
- 6 Continue previewing and editing settings as needed (all snapshot functions are available in preview mode).
- 7 When you are finished and need to exit Preview mode, press **F1** (or select the on-screen Preview button).

⚠ *Exiting Preview mode without storing will discard the changes made while in Preview mode (Preview mode is cleared each time you exit). You must explicitly store changes to update the associated snapshots.*

Undo and Preview Mode

In Preview mode, you can Undo actions applied to the Snapshot List (such as Recall, Store, New and Duplicate) without affecting the online mix.

 *Multiple levels of Undo are available.*

Changing Settings in Preview Mode

The system tracks any changes to settings or to the Snapshot list while in Preview mode, but only Snapshot list actions create an Undo point. Choosing Undo will undo the last action you took while in Preview mode, up to a maximum of 100 levels of Undo. Any changes made after the last Preview action are also undone (the Snapshot screen is returned to its exact state prior to the action that created the Undo point).

Changing the Snapshot List in Preview Mode

Changes made to the Snapshot list are automatically tracked and available for Undo, regardless of whether Preview mode is enabled or not. This includes any Recall of snapshots triggered by incoming MIDI or MTC while in Preview mode.

For example, if a MIDI Snapshot Recall occurs while you are in Preview mode, the online mix will be updated with that snapshot. Pressing Undo immediately after that Recall will undo that Snapshot recall and revert the online mix to its state prior to the Undo.

Consider turning off the Chase MTC option while in Preview mode to disable all MIDI recall of snapshots. In addition, you can always use the History feature to recover from any unexpected results.

Changing MIDI, Plug-In, and Media Data in Preview Mode

Changes made to MIDI, Plug-In, and Media data cannot be undone. For more information, see [Adding MIDI and Plug-In Data to Snapshots](#).

 *Take advantage of Tool Tips in the banner display to confirm what action the Undo button will revert. See [Undoing Snapshot Commands](#).*

Available and Unavailable Functions in Preview Mode

In order to maintain essential mix indicators and controls while in Preview mode, not all functions are taken offline.

The following sections detail what is and what is not available during Preview mode.

Always Active

Certain essential mix functions remain live and active at all times, regardless of whether Preview mode is enabled. The following vital mix functions continue to affect or be affected by the adjustments made to settings:

- Metering
- AFL/PFL
- Dynamics Key Listen
- Monitoring level, Headphone level and Monitoring bus Delay
- Talkback, Osc and 2-Track
- Mute Groups (recall only)
- Recall Safe
- MIDI snapshot Recall, Chase MTC and Disable (Snapshots)
- Snapshot list and Recall Safe (deleting, adding, or editing snapshots are/will be reflected online and affect the mix)
- History (auto-save)

Recall Safe in Preview Mode

The Recall Safe settings are global, and are applied to filter snapshot data regardless of the current operating mode. For details on Recall Safe and other automation safe features, see [Recall Safe](#).

Available and Editable in Preview Mode

Almost all system functions, such as selecting channels and banking faders, are available in Preview mode.

 *Only those controls that can be stored and recalled via snapshots are available for offline previewing and editing.*

Not Available in Preview Mode

The only controls not available while in Preview mode are those controls which are not able to be stored or recalled via snapshots. In addition, Config mode options are unavailable in Preview mode.

Unavailable functions include the following:

- Make Stereo, or Split to Mono
- Move channels
- Input channel Gain Guess
- Input channel Input Direct switch
- Insert mode (plug-ins cannot be edited)
- Enabling or disabling sample rate conversion

 *These functions are neither available for offline access in Preview mode, nor do they remain active (online) while in Preview mode. To adjust any of the above settings, you must exit Preview mode.*

Config Mode

Config mode is not available while in Preview mode. Pressing the Config switch (or double-selecting the Config/Show mode icon on-screen) displays a dialog box in which you can choose to “Exit Preview” (return to online mix, in Config mode), or “OK” (remain in Preview mode).

The system automatically switches to Show mode if Config mode is active at the time Preview mode is entered.

Plug-Ins and MIDI Data in Preview Mode

In Preview mode, plug-ins and MIDI data operate in a similar way as when using the standalone software.

You must explicitly add or update plug-ins and MIDI data to update snapshots, whether or not Preview mode is enabled. You can do this from the main Snapshot page, or (for plug-ins) from the plug-in racks.



Updating plug-in data in an associated snapshot from the plug-in view

Plug-Ins in Preview Mode

Recalling a snapshot that contains plug-in data affects the offline (Preview) routing and bypass state of the plug-in only; the online plug-in parameter settings are not recalled, and the online mix is not affected.

The following plug-in functions are available offline in Preview mode:

- Plug-in routing can be changed
- Plug-in rack view can be changed
- Plug-ins can be added to a snapshot to capture its current online parameter settings and (Preview mode) routing

The following plug-in functions are not available while in Preview mode:

- Plug-ins cannot be added to or removed from rack slots
- Plug-in presets cannot be recalled or saved
- Plug-in parameters cannot be changed (you cannot open plug-in windows while in Preview mode)
- Plug-ins cannot be installed

 For more information, see [Adding Plug-In Data to Snapshots](#).

MIDI in Preview Mode

Incoming MIDI or MTC continues to trigger snapshot recall while in Preview mode. However, MIDI messages stored to snapshots are not sent out when a snapshot is recalled in Preview mode. For more information, see [Adding MIDI Data to Snapshots](#).

MTC/LTC and Other Online Event Triggers

While in Preview mode, triggers that occur in the online state of the system are executed, including MTC-or LTC-driven recall of snapshots. Triggers caused by changes to the offline (Preview) controls are ignored and do not cause events to occur. For more information, see [Events](#).

Adding MIDI and Plug-In Data to Snapshots

You can add MIDI and plug-in data to snapshots using the MIDI/Plug-In list. Open the list to add and edit data. You can expand the list for a larger view of list items.

To open the MIDI/Plug-Ins list:

- On the Snapshots page, select the MIDI or PLUG-INS button.

To expand the To open the MIDI/Plug-Ins list:

- Select the Expand button.

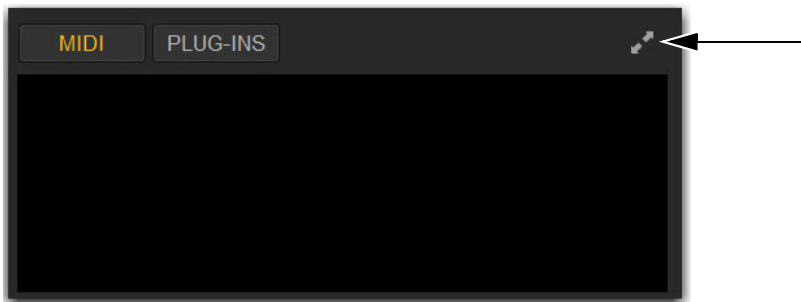

MIDI/Plug-Ins List Expand button

Adding MIDI Data to Snapshots

When the MIDI data type is scoped for a snapshot, any stored MIDI messages are sent when the snapshot is recalled.

The following MIDI messages are supported and available in the MIDI list:

- Note Off
- Note On
- Poly Key Pressure
- Control Change
- Program Change
- Channel Pressure
- Pitch Bend
- MIDI Machine Control Stop
- MIDI Machine Control Play
- MIDI Machine Control Fast Forward
- MIDI Machine Control Rewind
- MIDI Machine Control Eject
- MIDI Machine Control Chase
- MIDI Machine Control Pause
- MIDI Machine Control Locate

When the MIDI data type is scoped for a snapshot, its MIDI messages are sent when the snapshot is recalled.

No MIDI message data is captured when a snapshot is first created. MIDI messages are added to existing snapshots directly from the MIDI pop-up menu. You can store up to 20 MIDI messages in each snapshot.

To add a MIDI message to a snapshot:

- 1 Target the snapshot you want to modify.
- 2 Select the Expand button.
- 3 Select Add and choose a message from the pop-up menu.

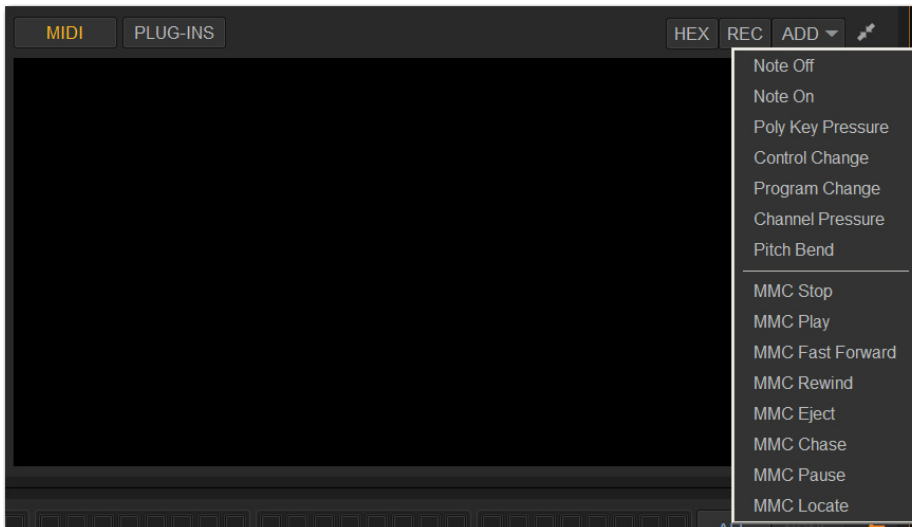

Snapshot MIDI pop-up menu

The MIDI lights in the Snapshots list for each snapshot that contains MIDI messages.

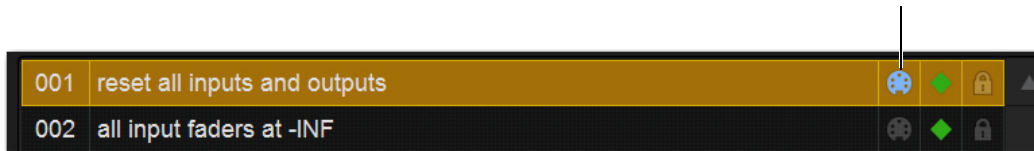

Lit and unlit MIDI icons in the Snapshots list

To record incoming MIDI data to a snapshot.

- 1 Select REC.
- 2 Send a supported MIDI command.
- 3 Select REC again when done.

To edit a MIDI message in the MIDI list:

- 1 Double-select the message text to display the pop-up menu bar for the message.

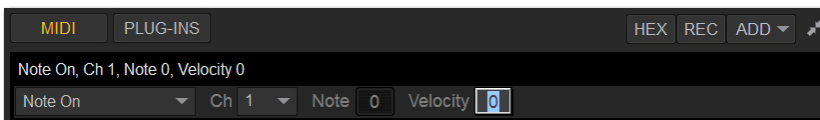

Editing a MIDI message in the snapshot MIDI list

- 2 Choose the message name and send channel or device ID from the pop-up menus.
- 3 Enter the message values in the text fields or drag up or down across the text field to change the values.
- 4 Select in the MIDI list area to dismiss the pop-up menu bar.

To remove a MIDI message from a snapshot:

- Touch-and-hold the MIDI message in the MIDI list and choose Delete.

Viewing MIDI Messages in Hexadecimal Format

You can toggle the view of MIDI messages in the MIDI list between hexadecimal and decimal formats.

To toggle the view format of the MIDI list:

- Select the Hex button in the MIDI/Plug-Ins list header.

Safing MIDI Message Output

You can temporarily disable output of embedded MIDI messages so that they are not sent when a snapshot is recalled, even when the MIDI data type is scoped.

 MIDI output is automatically suspended while in Preview mode.

To safe MIDI message output on-screen:

- 1 Go to the Snapshots page and select the Recall Safe tab.
- 2 Select the MIDI global output Safe button above the parameter matrix so that it lights.

Adding Plug-In Data to Snapshots

When the Plug-In data type is scoped for a snapshot, plug-in routing, in/out state, and settings are recalled with the snapshot. (Adding or changing plug-in side-chain routing is not supported in snapshots.)

The Snapshots Plug-Ins list lets you select multiple plug-ins and add, remove and update them simultaneously across one or more snapshots. Multiple snapshots can be selected, and others can be added to or removed from the selection, at any time prior to adding, removing, or updating plug-ins and snapshots.

No Plug-In data is captured when a snapshot is first created. Plug-In data is added to existing snapshots from the Plug-Ins list or from the Plug-In rack.

Adding Plug-Ins to Snapshots

To add a plug-in to one or more snapshots from the Snapshots page:

- 1 Select one or more snapshots in the Snapshots list.
- 2 Select the Expand button in the MIDI/Plug-Ins list to expand the Plug-In list.
- 3 Select the ADD button within the Snapshot Plug-Ins list and select a plug-in (or All Plug-Ins) from the menu.

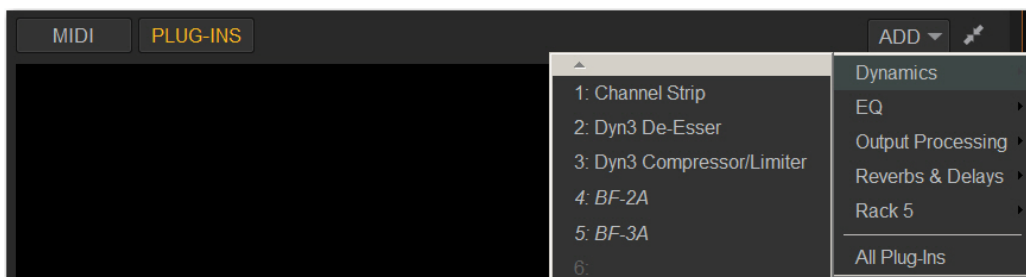

Snapshot Plug-In list

To add a plug-in to snapshots from the Plug-Ins page:

- 1 Select one or more snapshots in the Snapshots list.
- 2 Go to the Plug-Ins page.
- 3 Select the Snapshots menu for the plug-in to be added and choose Add This Plug-In To Selected Snapshots. The selected plug-in is added to the currently targeted snapshot, as well as all other snapshots within the multi-selection.

Snapshots within the multi-selection that already contained the plug-in being added are unaffected and preserve any previously stored settings.

Removing a Plug-In from Snapshots

To remove a plug-in from snapshots from the Snapshots page:

- 1 Select an individual snapshot, or create a multi-selection of snapshots in the Snapshots list.
- 2 Select the Snapshots Plug-Ins icon to show the Snapshots Plug-Ins list.
- 3 Touch-and-hold a plug-in within the plug-in list of the currently targeted snapshot and choose Remove This Plug-In From Selected Snapshots.

To remove a plug-in from snapshots from the Plug-Ins page:

- 1 Select one or more snapshots in the Snapshots list.
- 2 Go to the Plug-Ins page. All plug-ins that are associated with any of the currently selected snapshots are identifiable by a red Snapshot selector.
- 3 Select the red Snapshot selector for the plug-in to be removed and choose Remove This Plug-In From Selected Snapshots.

The selected plug-in is removed from the currently targeted snapshot, as well as all other snapshots within the multi-selection. Only snapshots within the multi-selection that contain the selected plug-in are affected.

Updating a Plug-In Across Snapshots

To update a plug-in across snapshots from the Snapshots page:

- 1 Select one or more snapshots in the Snapshots list.
- 2 Select one or more plug-ins (shift-select) within the plug-in list of the currently targeted snapshot

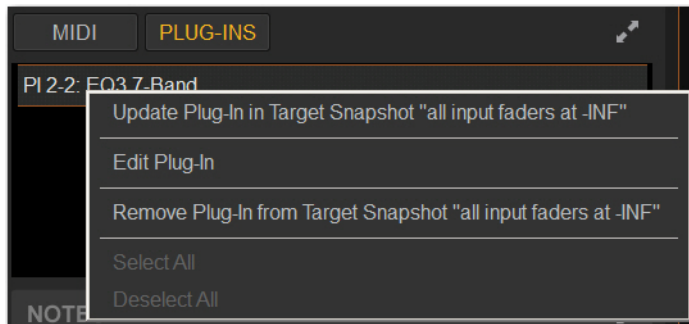

Snapshots plug-ins pop-up menu with multiple plug-ins selected in the Snapshots Plug-Ins list

- 3 Touch-and-hold the desired plug-in within the plug-in list and choose Update Plug-In In Selected Snapshots.

To update a plug-in across multiple snapshots from the Plug-Ins page:

- 1 Select one or more snapshots in the Snapshots list.
- 2 Go to the Plug-Ins page. All plug-ins that are associated with any of the currently selected snapshots are identifiable by a red Snapshot selector.
- 3 Select the Snapshot selector for the plug-in to be updated and choose Update This Plug-In In Selected Snapshots.

The selected plug-in is updated within the currently targeted snapshot, as well as all other snapshots within the multi-selection. Snapshots within the multi-selection that do not already contain the plug-in being added are unaffected.

Editing Plug-Ins

The Snapshot page provides two ways to quickly navigate to a plug-in to edit its routing assignment or parameters.

To edit a plug-in associated with a snapshot:

- Double-tap the item in the Snapshot Plug-Ins list. Or, in the Snapshots Plug-Ins list touch-and-hold a plug-in and choose Edit Plug-In.

Adding Tempo Data to Snapshots

The Snapshots list can be toggled to display Tempo, along with a Tempo On/Off indicator for each snapshot entry.

Storing a tempo with snapshots lets your system tempo change per song or scene. This lets you take full advantage of Tempo Sync (aka Tap Tempo) to synchronize delay and echo plug-ins. The System Tempo is set on the Options > Misc page. For details on configuring the system tempo and using it to synchronize plug-ins, see [Tap Tempo for Plug-ins](#).

Displaying Tempo in the Snapshots List

To show Tempo in the Snapshots list:

- Touch-and-hold anywhere in the Snapshots list and choose Show Tempo.
Tempo is displayed in BPM (beats per minute) or milliseconds, as set in the Options > Misc page.

To change the units for Tempo display:

- 1 Go to the Options > Misc page.
- 2 In the Tap Tempo section, select BPM or ms.

Assigning and Enabling a Tempo

Each snapshot can store a custom tempo value. You can manually enter a custom tempo, or use a shortcut to assign the current System Tempo.

You can use the Tempo Enable icon to enable or disable tempo recall when the associated snapshot is recalled.

To assign a Tempo value to a snapshot manually:

- 1 In the Snapshots list, double-tap the Tempo value you want to change, then do one of the following:
 - From the keyboard, type a new tempo value.
 - Press the Up and Down Arrow keys to increase and decrease the selected value.
- 2 Press Enter or select another snapshot Tempo value to confirm the entry.

To assign the current System Tempo to a snapshot:

- 1 Make sure Tempo is shown in the Snapshots list.
- 2 Touch-and-hold and choose the Set Tempo to option, which will display the current System Tempo.

To toggle tempo on/off for each snapshot:

- 1 Make sure Tempo is shown in the Snapshots list (if not, touch-and-hold any item in the list and choose Show Tempo).
- 2 Select the Tempo icon. The icon lights when tempo is enabled.

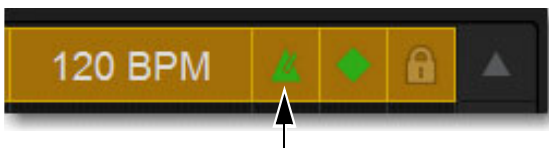

The current tempo and a lit Tempo icon in the Snapshots list

Adding Pro Tools Markers Using Snapshots

With VENUE Link enabled, you can set individual snapshots to create a new Marker in the Pro Tools Timeline. While Pro Tools is recording, whenever that snapshot is recalled, a new Marker is created and named according to the recalled snapshot.

 For more information, see the *VENUE S6L Live Recording Guide.pdf*.

Displaying the Marker Icon

To show Markers in the Snapshots list:

- Touch-and-hold anywhere in the Snapshots list and choose Show Markers.

A lit Markers icon indicates that recalling that snapshot will create a new Marker in the Pro Tools timeline when recording.

Snapshot Options

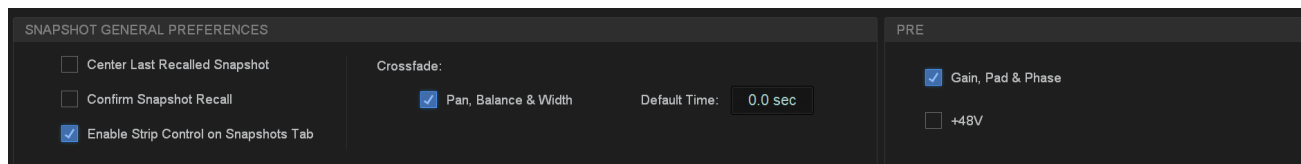

Snapshot options

Center Last Recalled Snapshot

The Options > Snapshots page provides a preference setting to always center the Snapshot list on the last recalled snapshot. When enabled, the Center Last Recalled Snapshot setting lets you always view the snapshots immediately above and below (prior to and following) the last recalled snapshot. This setting only affects the scroll position of items in the Snapshot list.

Confirm Snapshot Recall

When this setting is enabled, a warning dialog appears when any snapshot is recalled asking to confirm the operation. When not enabled, recalling snapshots requires no confirmation.

Enable Strip Control on Snapshots Tab

When this setting is enabled (the default setting), you can adjust channel faders, Safe, Solo, and Mute controls in the strips sections along the bottom of the main Snapshot tab. When not enabled, these controls cannot be adjusted on-screen (legacy behavior).

Crossfade Time

You can set the X-fade (crossfade) time for the channel faders between snapshots from 0–99.9 seconds, in 0.1 second increments. This value determines the *fade time*, or the time it takes for the controls to move to their new positions when a snapshot is recalled. In addition to channel faders you can optionally enable snapshot crossfade for pan/balance/width,

All other controls are unaffected by the crossfade time, and are updated instantly when a snapshot is recalled. Each snapshot may be assigned its own crossfade time. In addition, crossfades will continue through a subsequent snapshot recall as long as the crossfading channels are not scoped in the incoming snapshot.

Pan, Balance & Width

Enable this setting have channel pan parameters follow snapshot crossfade settings.

Default Crossfade Time

The default crossfade time assigned to new snapshots can be set with this option, with a possible range of 0–99.9 seconds.

To set the Default Crossfade Time:

- Go to Options > Snapshots, then under Snapshot General Preferences enter a value or drag in the text box and press Enter.

Snapshots

Crossfade Bypass

Snapshot crossfades can be up to 99.9 seconds. You can quickly bypass (cancel) a crossfade and immediately advance to the stored snapshot fader settings in order to speed up rehearsals, or whenever on-stage action moves faster than a programmed crossfade.

To bypass a snapshot crossfade:

- Recall the same snapshot at any point during the crossfade. Doing so recalls the entire contents of that snapshot, in addition to bypassing the crossfade. This is equivalent to recalling the snapshot with an effective crossfade time of 0 seconds. Any scoped parameters which were manually changed during the crossfade time will be reset to the values stored in the snapshot.

Special Cases for Crossfade Bypass

Incoming MIDI Commands The snapshot crossfade is not bypassed if a MIDI Program Change message recalling the same snapshot is received during the crossfade.

MTC The snapshot crossfade is not bypassed if a MTC trigger recalling the same snapshot occurs during the crossfade.

Multiple Simultaneous Crossfades The crossfade can be bypassed for the most recently recalled snapshot only.

Preview Mode If you enter Preview mode in between Recall commands, the offline (Preview mode) crossfade will be bypassed; the online crossfade will not.

Pre Settings

Snapshots can be used to recall the preamplifier settings on inputs for all scoped input channels. You can set any of the following Pre parameters to be recalled by the Pre data type button: Gain, Pad and Phase/polarity, +48V (Phantom Power), HPF corner frequency and in/out state.

To set the Pre parameters recalled by the Pre Data Type button:

- Go to Options > Snapshots.
- Under Pre, select the options you want to include. Selected items will be affected when the Pre data type is included in the scope of a snapshot.

Classifying Aux Sends

You can classify Aux Sends as *monitor sends* (“Aux Mon”) or as *effects sends* (“Aux FX”), which lets you scope each type separately from the Snapshots tab of the Options page.

 This option is only a means of organizing Aux Sends for snapshot control, and does not directly affect Aux bus operation. See also [User Aux Scope](#).

To classify Aux Sends for snapshot scope:

- Go to the Options page and select the Snapshots tab.
- For each Aux Send bus or bus pair, select the Aux Mon or Aux FX buttons to classify it as a monitor send or effects send, respectively.

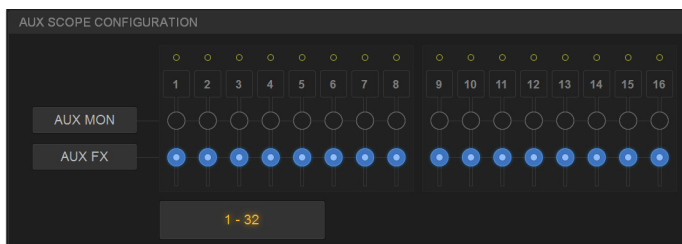

Classifying Aux Sends

Aux Pre/Post State

Select this option to include the pickoff point pre-fader or post-fader state of each Aux Send in snapshots.

User Aux Scope

The User Aux tab provides a grid that lets you scope individual Aux Sends per Input channel, to specify which Aux Sends on each input to include or exclude when storing and recalling snapshots.

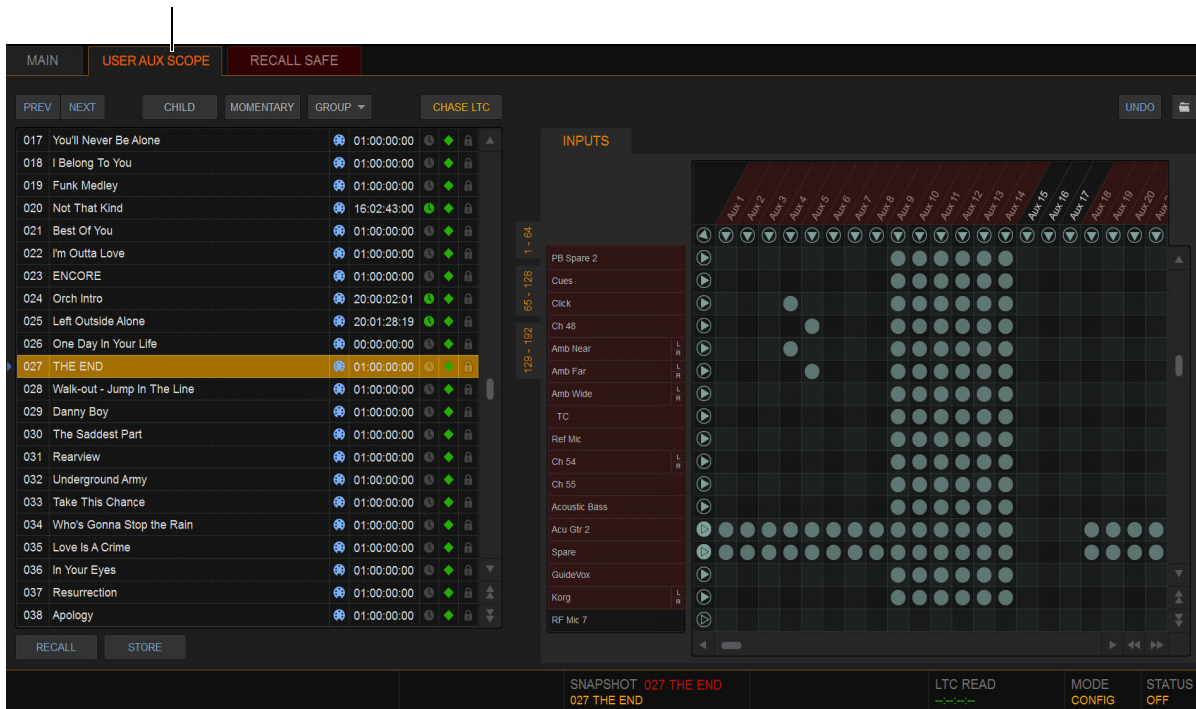

User Aux Scope tab (at top) and grid (at right) shown in the Snapshots tab

In addition, the Data Type Scope button **AUXUSR** (Aux User) is provided in the main Snapshots tab. This button enables (includes) or disables (excludes) User Aux grid settings from being recalled by snapshots.

User Aux Scope Example

The ability to include or exclude individual Auxes in snapshots has many applications, including monitor mixing.

For example, you can configure a single snapshot to raise the monitor level of a specific input such as lead guitar only in the mix for the lead guitarist. By scoping only the Aux feeding the guitarists monitor mix on the guitar input channel, recalling a snapshot with that Aux raised a few dB will not affect the guitar level in other performers' monitors.

The example image to the right shows the User Aux Scope grid configured for this example. A snapshot "003 Gtr 1_Solo +2dB IEM 3" has been stored with only the Aux "IEM 3" scoped for the input channel "GTR E 1_stg L."

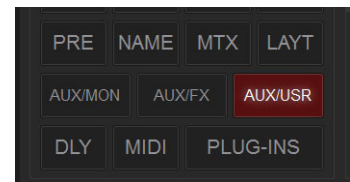

Using the User Aux Scope Grid

To enable User Aux Scope settings:

- 1 Go to the Snapshots page.
- 2 On the Main tab, enable the AUX/USR button in the Scope section.

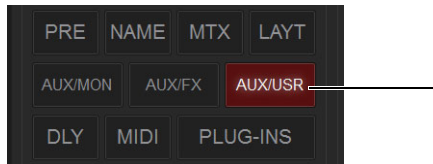

AUX/USR button enabled in the Scope section of the Snapshots Main tab

When the AUX/USR button is enabled:

- The matrix in the User Aux Scope tab becomes active.
- Settings in the User Aux Scope tab are recalled with the current snapshot(s), as long as they are not Recall Safed.

When the AUX/USR button is not enabled the User Aux tab remains available but the matrix is taken offline and is grayed out, indicating User Aux Scope settings will not be recalled with the current snapshot(s).

Aux Mon, Aux FX, and Aux User

When the AUX/USR Data Type Scope button is enabled in the Main tab of the Snapshots page, the AUXMON and AUXFX Data Type Scope buttons remain available and control scope for Auxes classified as Mon or FX in the Options > Snapshots screen. Enabling AUXMON or AUXFX scopes the corresponding Auxes; by enabling AUX/USR you can add (or remove) individual Auxes.



The AUXMON and AUXFX scope buttons do not affect and are not affected by the AUX/USR button. The User Aux matrix does not indicate scope status of AUXMON or AUXFX.

To access the User Aux Scope grid:

- 1 Go to the Snapshots page and make sure the AUX/USR Data Type Scope button is enabled.
- 2 Select the User Aux Scope tab. Select a Channel tab to display the desired Input channels.

To scope individual Auxes on specific Input channels:

- 1 Make sure the desired Input channels are scoped (fader strips are red) in the Snapshot Main tab.
- 2 In the User Aux tab, select in the grid at the intersection of the appropriate Aux (column) and channel (row). A dot appears, indicating that the corresponding Aux on that channel is scoped.

To scope multiple Auxes or channels at a time:

- Touch and drag in a column, across a row, or at an angle.

To scope an Aux across all currently displayed channels:

- Select the Aux grid icon at the top of the appropriate column until the triangle is white.

To scope all Auxes for a particular channel:

- Select the Channel grid icon next to the Channel Name in the appropriate row until the triangle is white.

To toggle the status of an entire Aux column or channel row:

- Select the appropriate Aux or Channel grid icon repeatedly until it displays the desired status. For more information, see [5 – User Aux Scope Matrix](#).

To scope all Auxes across all channels and clear any current settings:

- Select the triangular icon at the upper left of the matrix (at the top of the ALL column).



You can undo or redo the last action taken in the matrix. Selecting a different snapshot clears the Undo.

Using Aux User Presets

The configuration of the Aux User tab can be stored as a User Aux Scope settings file. User Aux Scope settings (presets) can be previewed, recalled and transferred just like plug-in, EQ and dynamics settings.

To store the current User Aux Scope settings as a preset:

- 1 Configure the User Aux Scope tab as desired.
- 2 Select the Presets icon (the folder icon located above and to the right of the matrix).
- 3 Select New.

To preview and recall a saved preset:

- 1 From the User Aux Scope tab, select the Presets icon to display the User Aux Scope Presets window.
- 2 If necessary, choose the appropriate folder by selecting it from the Folder selector.

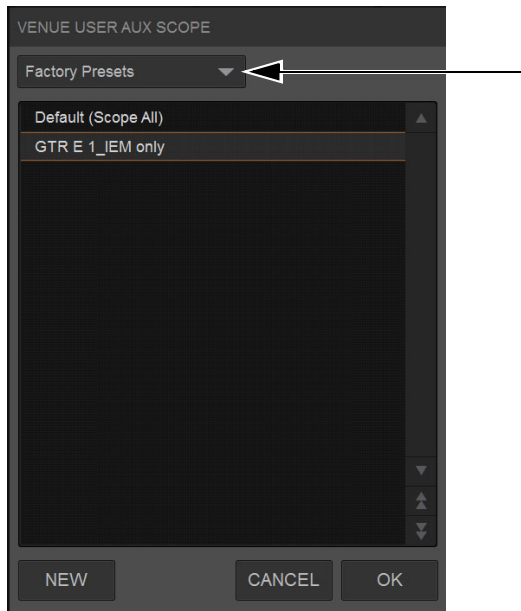

User Aux Scope presets Folder selector

- 3 Do any of the following:
 - To preview an existing preset, select its name in the window.
 - To load the currently selected preset, press Enter or press OK in the window title bar.
 - To cancel without changing User Aux Scope settings, select Cancel.

Transferring User Aux Scope Presets

You can transfer User Aux Scope presets from the Filing page. To access User Aux Scope presets, touch-and-hold (right-click) Scope Sets and choose User Aux Scope from the pop-up menu.

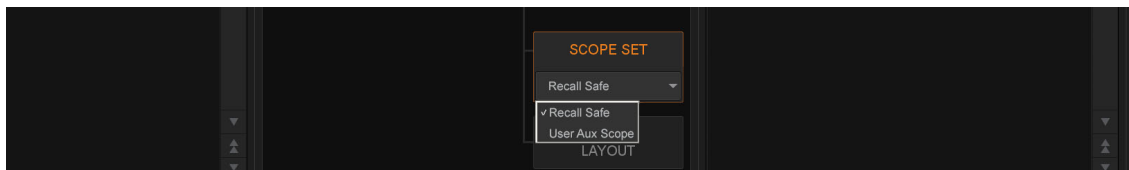

Selecting Recall Safe or User Aux Scope

User Aux Scope Displays and Controls

The User Aux Scope tab provides the following displays and controls.

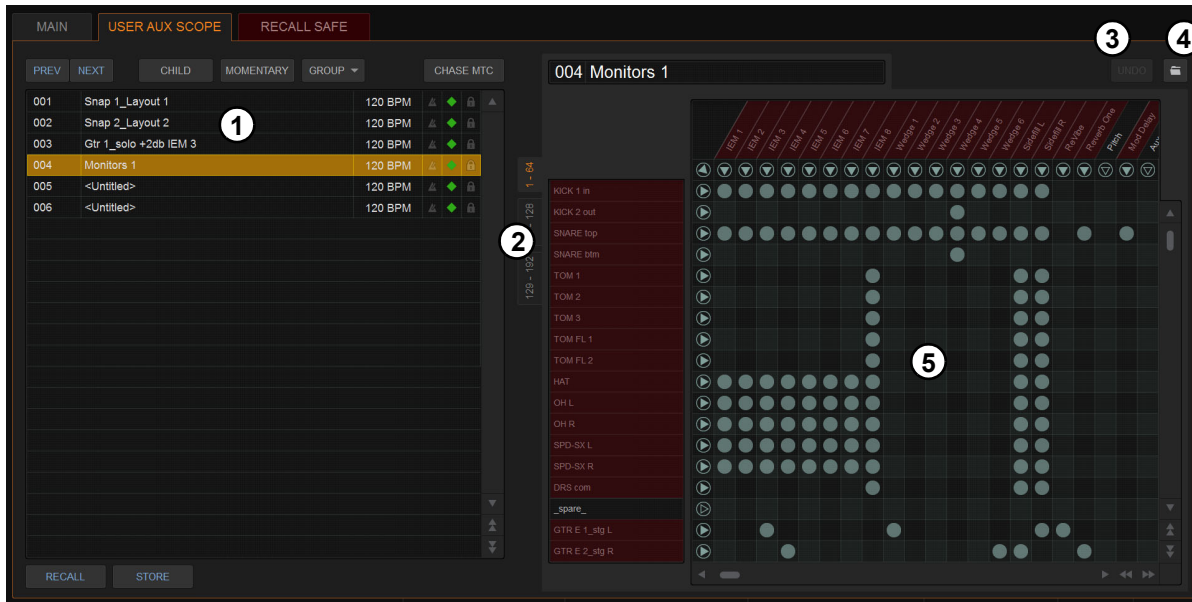

Primary displays and controls in the User Aux Scope tab

1 – Snapshot List

The Snapshot list and its primary functions (such as Previous and Next) remain visible and available from the User Aux Scope tab.

2 – Channel Tabs

Along the left side of the matrix are the Channel tabs, which select different ranges of Input channels listed in the matrix.

3 – Undo

The Undo function lets you undo the last action applied to the User Aux Scope matrix.

⚠ Targeting (selecting) a different snapshot clears the User Aux Undo function.

4 – User Aux Scope Presets

See [Channel Safe](#).

5 – User Aux Scope Matrix

The User Aux Scope matrix is a scrollable grid in which you can scope individual Auxes and Input channels. You can undo and redo matrix operations.

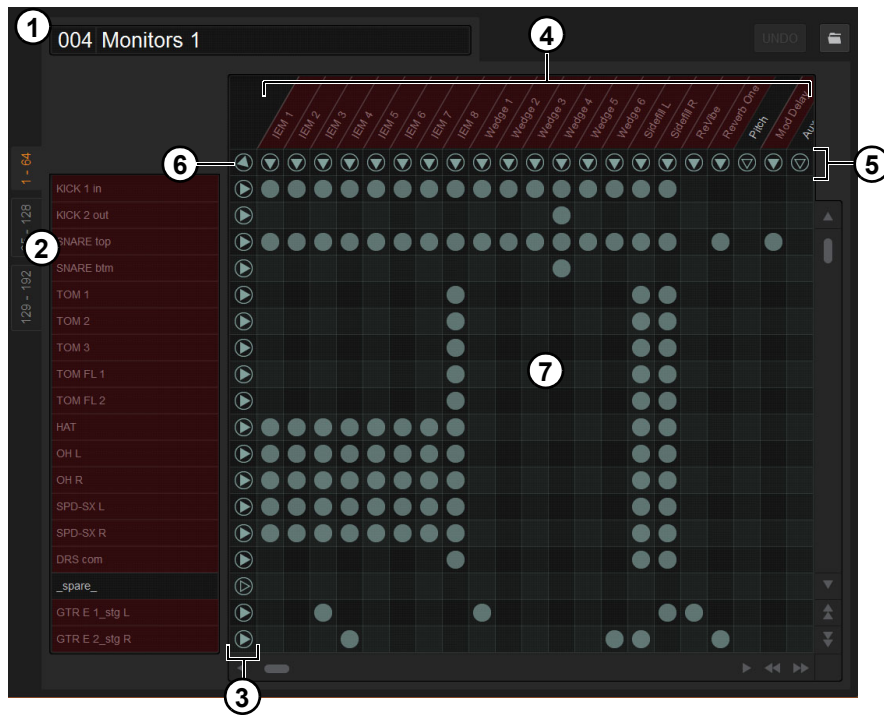

User Aux Scope matrix

The following table describes the elements of the User Aux Scope matrix shown in the figure above.

Legend	Item	Description
1	Snapshot	Displays the name of the currently targeted snapshot
2	Channels	Tab select ranges of Input channels shown in rows in the list. Red indicates scoped channels (for a channel to be scoped and red it must be scoped in the Snapshots Main tab). Double-clicking an Input Channel name lets you rename it.
3	Channel icons	Toggles scope of all Auxes on the corresponding channel; indicates scope status for that row
4	Auxes	All available Auxes are listed across the top of the matrix. Red indicates scoped Auxes
5	Aux icons	Toggles scope of the corresponding Aux on all channels; indicates scope status for that column
6	“All”	This single icon (above all Channel icons and to the left of all Aux icons) toggles scope on/off for all channels and Auxes
7	Grid	Matrix of channels and Auxes. A lit circle indicates that Aux is scoped on that channel

Matrix Icons

The display state of the Aux and Channel grid icons indicate scope status for that column or row as follows:

Icon	Name	Description
	None	A dark Aux or Channel grid icon indicates that no items in that column or row are scoped.
	Some	A lit triangle inside an unlit circle indicates that at least one item in that column or row is scoped.
	All	A lit (white) triangle and circle indicates that all items in that column or row are scoped.

Recall Safe

Recall Safe lets you select which parameters on which channels you want to be “safed” from snapshots. Recall Safe is global to all snapshots, can be turned on or off quickly, and provides preset capabilities in the form of Scope Sets. Scope Sets can be loaded and saved just like Presets for built-in EQ, dynamics, and plug-in settings. Current Recall Safe settings are stored with the Show file.

 *Individual channels can be safed from all effects of snapshot recall using channel Automations Safe. See [Managing Snapshots](#).*

To access Recall Safes:

- 1 On the external screen, go to the Snapshots page and select the Recall Safe tab. The Recall Safe tab is red when Recall Safe is on and in effect, and gray when Recall Safe is off or when nothing is safed.



Indication of active Recall Safe from the main Snapshots page

Recall Safe Displays and Controls

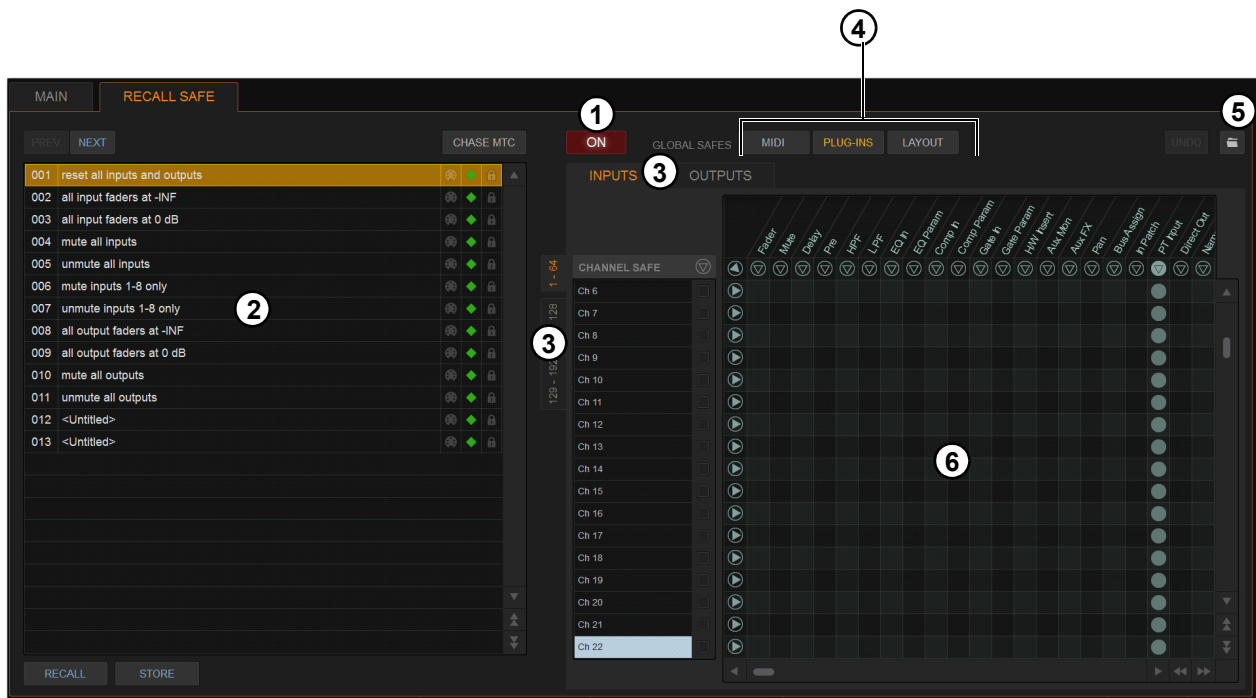

Displays and controls in the Recall Safe tab

1 – On

The master On button toggles the entire Recall Safe feature on or off globally. When lit (blue), Recall Safe is active. When dark, Recall Safe is suspended.

2 – Snapshot List, Recall and Store

The Snapshot list and its Recall and Store functions remain visible and available from the Recall Safe tab at all times.

3 – Channel and Channel Type Tabs

The Inputs and Outputs tabs at the top of the parameter matrix selects the channel type whose safe status you want to view or edit. Along the left side of the parameter matrix are the Channel Type tabs, which change depending on whether you are viewing Input or Output tabs.

4 – Global Safe for MIDI Output, Plug-Ins, and Media

These checkboxes let you globally suspend recall of MIDI output, plug-in changes and/or Media page Transport commands. They are considered separate from the parameter matrix and do not follow the Recall Safe master On (or Off) status.

5 – Scope Sets

Scope Sets are presets for the Recall Safe tab that can be stored and loaded, just like plug-in, EQ and dynamics presets. Scope sets can be used as a template when creating new Shows, or used to change Recall Safe settings during a performance. Like other presets and settings files, Scope Sets can be transferred from the Filing page, making it easy to maintain and transfer Recall Safe configurations. For more information, see [Using Scope Sets](#).

6 – Parameter Matrix

The parameter matrix is a scrollable grid in which you can safe parameters and channels. You can undo and redo parameter matrix operations.

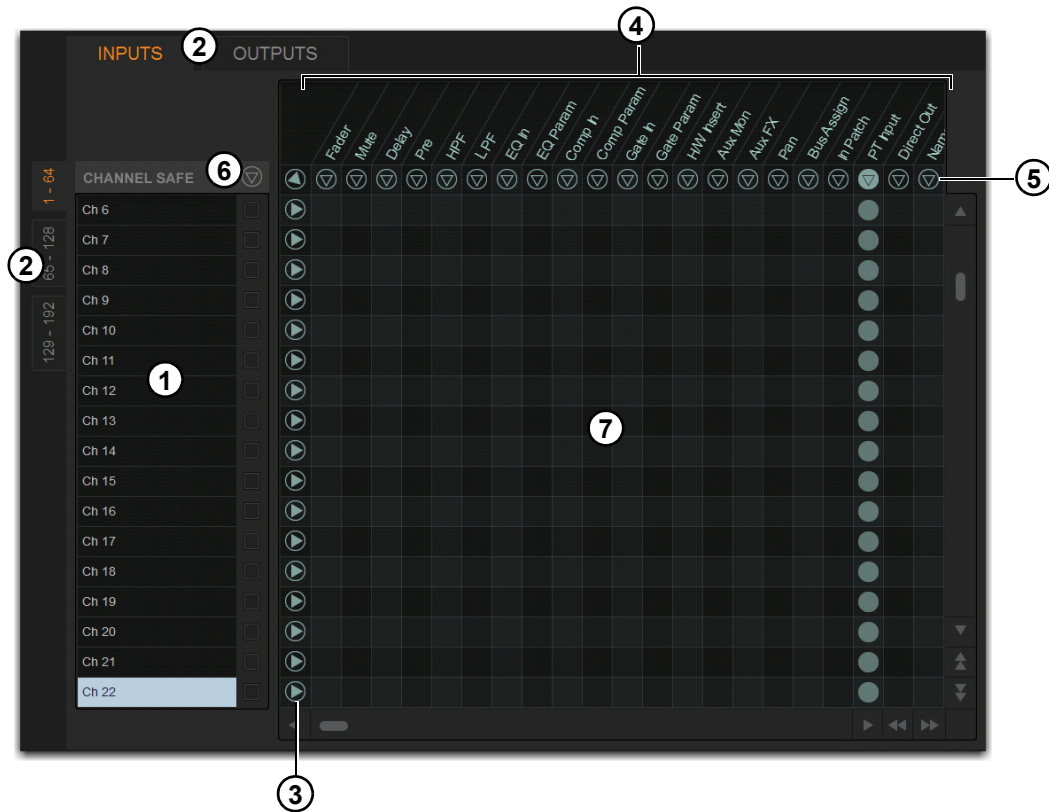

Parameter matrix for Recall Safe

1 – Channels

2 – Channel Type Tabs

3 – Channel Icons

4 – Parameters

5 – Parameter Matrix Icons

6 – Channel Safe Button

7 – Grid

Parameters are represented in the columns of the parameter matrix; channels are listed along the left side in rows.

Selecting in the grid enables safe status for that parameter on that channel. Parameter and Channel grid icons provide shortcuts to quickly “safe all” parameters, and to safe entire channels. Selecting these icons lets you quickly toggle recall safe status for entire columns and rows. You can also use the master grid icon located in the upper left most corner to toggle the entire grid.

Parameter Matrix Icons

The display state of the Parameter and Channel grid icons indicate safe status for that column or row as follows:

None A dark Parameter or Channel grid icon indicates that no items in that column or row are safe enabled.

Some A dark triangle inside a lit blue circle indicates that at least one item in that column or row is safe enabled.

All A lit (white) triangle indicates that all items in that column or row are safe enabled.

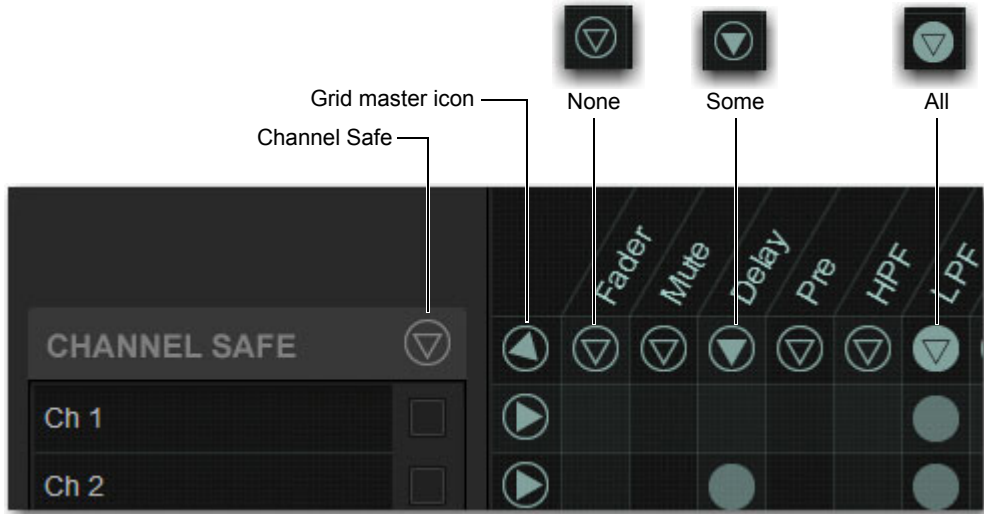

Display states for grid icons in Recall Safe

Channel Safe Controls

The CHANNEL SAFE column acts as a global “all channel” setting or override, mirroring the Channel Safe switches and buttons (when in Channel Safe Switches act as Automation Safes mode).

Controls in the CHANNEL SAFE column are not part of the parameter matrix; they function *in addition to* the parameter matrix. As a result, you do not need to enable any CHANNEL SAFE settings to use the Recall Safe parameter matrix.

 For more information, see [Managing Snapshots](#).

Using Recall Safe

To access Recall Safe:

- 1 Go to the Snapshots page and select the Recall Safe tab.
- 2 Select a Channel Type tab to display the desired channels.

To safe individual parameters on specific channels:

- Select in the grid at the intersection of the appropriate parameter (column) and channel (row). A blue dot appears, indicating a parameter is safed.

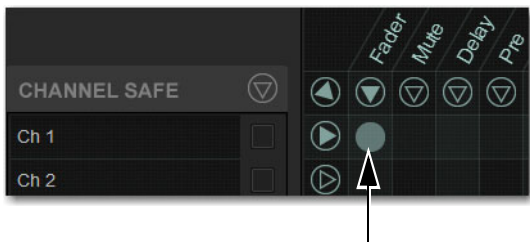

Enabling recall safe for channel 1 fader

To safe multiple parameters or channels at a time:

- Touch and drag in a column, across a row, or at an angle.

To safe a parameter across all currently displayed channel types:

- Select the Parameter grid icon at the top of the appropriate column until the triangle is white.

To safe all parameters for a particular channel:

- Select the Channel grid icon in the ALL column for that channel (row).

To toggle the status of a parameter column or channel row:

- Select the appropriate Parameter or Channel grid icon repeatedly until it displays the desired status. For more information, see [6 – Parameter Matrix](#).

To safe all parameters across all channels and clear any current settings:

- Select the triangular icon at the top of the ALL column.



You can undo or redo the last action taken in the parameter matrix.

Channel Safe

To automation safe an individual channel and retain all recall safe settings for that channel:

- Select in the CHANNEL SAFE column for the desired channels.



A channel (row) Channel Safe button does not need to be lit in order to Recall Safe individual parameters for that channel.

To automation safe all parameters across all channels and retain all current recall safe settings:

- Select the CHANNEL SAFE master icon at the top of the Channel Safe column.



The Channel Safe column mirrors the channel automation Safe controls. For more information, see [Managing Snapshots](#).

MIDI

When engaged, this button prevents the MIDI data stored in the snapshot from being sent. This does not affect sending of Bank Select and Program Change commands with the Snapshots Send on Channel option (Options > Snapshots > MIDI).

To enable Recall Safe for MIDI Snapshot output:

- Select the MIDI Snapshot Output Safe button, located above the parameter matrix.

 For more information, see [Adding MIDI Data to Snapshots](#).

Plug-Ins

When engaged, this button prevents plug-in control settings, in-circuit state, and routing from being recalled.

To enable Recall Safe for plug-ins:

- Select the Plug-In Snapshot Safe button, located above the parameter matrix.

 For more information, see [Adding Plug-In Data to Snapshots](#).

Media

When engaged, this button prevents USB 2-track record and playback transport commands for from being recalled.

To enable Recall Safe for USB 2-track Transport controls:

- Select the Media Snapshot Safe button, located above the parameter matrix.

 For more information, see [Adding Tempo Data to Snapshots](#).

Matrix

Snapshots can store and recall all source assignments of each matrix mixer when the Matrix data types is scoped. In addition, all User Input assignments are stored, letting you reconfigure Matrix mixers and User Input assignments on a per snapshot basis, if desired.

The Recall Safe tab provides two data “Mix” data types that let you discretely “safe” source and/or user input assignments to prevent them from being changed with a snapshot recall.

The following table describes what can be stored and recalled in each snapshot when the Matrix data types is scoped.

Table 4. Snapshot data types and parameters for Matrix mixers

Snapshot Data Type	Included Parameters (for Each Scoped Channel Strip)
Matrix	Mixer Input Sources, User Input Assignments (global to all Matrixes), and pickoffs; Mixer Input level, Mixer Input on/off and Mixer Input Link

Using Scope Sets

The configuration of the Recall Safe tab can be stored as a Scope Set settings file. Scope Sets can be previewed, recalled and transferred just like plug-in, EQ and dynamics settings.

To store the current Recall Safe settings as a Scope Set:

- 1 Configure the Recall Safe tab as desired.
- 2 Select the Scope Sets icon (the folder icon located above and to the right of the parameter matrix).
- 3 Select New.

To preview and recall a saved Scope Set:

- 1 From the Recall Safe tab, select the Scope Set icon to display the Scope Set window.
- 2 If necessary, choose the appropriate Scope Sets folder by selecting it from the Folder selector.

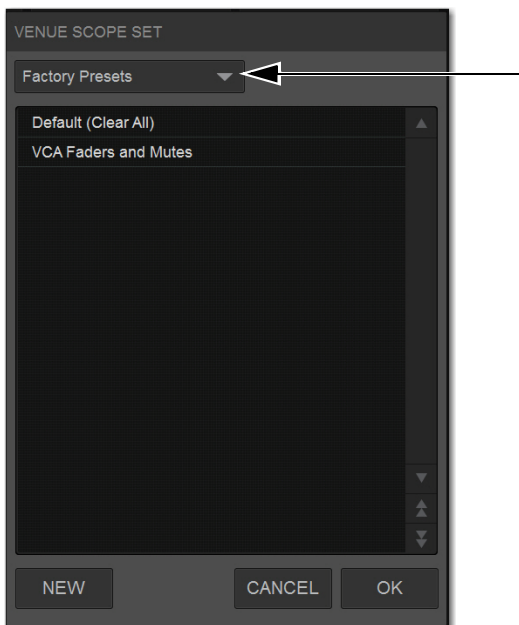

Scope Sets Folder selector

- 3 Do any of the following:
 - To preview an existing Scope Set, select its name in the Scope Sets window.
 - To load the currently selected Scope Set, press Enter or press OK in the Scope Sets window title bar.
 - To cancel without changing Recall Safe settings, select Cancel.



See [Filing](#) for complete information on transferring system data.

Automation Safing Channels

Automation Safing a channel lets you suspend the effect of snapshots on all parameters of the channel. You can Automation Safe channels using the Channel Safe switches, the Channel Knob Module (CKM) in Channel Control mode, or the Channel Menu. To Automation Safe channels using the Channel Safe switches, you must first enable Automation Safe mode.

Automation Safing Using the Channel Safe Switches/Button

The Channel **Safe** switch on the S6L control surface and the Channel Safe button on the external software screen toggle Automation Safe for that channel when Automation Safe mode is enabled. Automation Safe Mode is enabled globally for input and output channels on the Options > Interaction page of the external screen.

To enable Automation Safe for the Channel Safe switches:

- 1 On the external screen, go to the Options > Interaction page.
- 2 In the Channel Safe Switches section, under Inputs and Outputs, select Automation Safes as desired.

 You can create an event that lets you cycle through the various Channel Safe switch modes, as well as suspend or disable Automation Safe. See [Creating Events](#).

To Automation Safe channels using the Channel Safe switches:

- 1 Make sure you have enabled Automation Safe for the Channel Safe switches.
- 2 On the S6L control surface, do the following:
 - Bank the desired channel to the faders.
 - Press **Safe** for the channel you want to Automation Safe.



S6L Channel Safe switch engaged

- 3 On the external screen, do the following:
 - Go to the Inputs or Outputs page, and navigate to the desired channel using the provided tabs and buttons.
 - Select the Channel Safe switch for the desired channel, located at the top of each fader strip.

Automation Safe status for the channel is indicated as follows:

- On the control surface channel strip, the **A** LED lights green.
- In the Input section of the MTS and CTM Channel view for the channel, **A** lights green.
- On the external screen the Safe button flashes green and shows the letter B (A appears if the switch is acting as an Automation Safe, and S appears if it is acting as a Solo Safe).

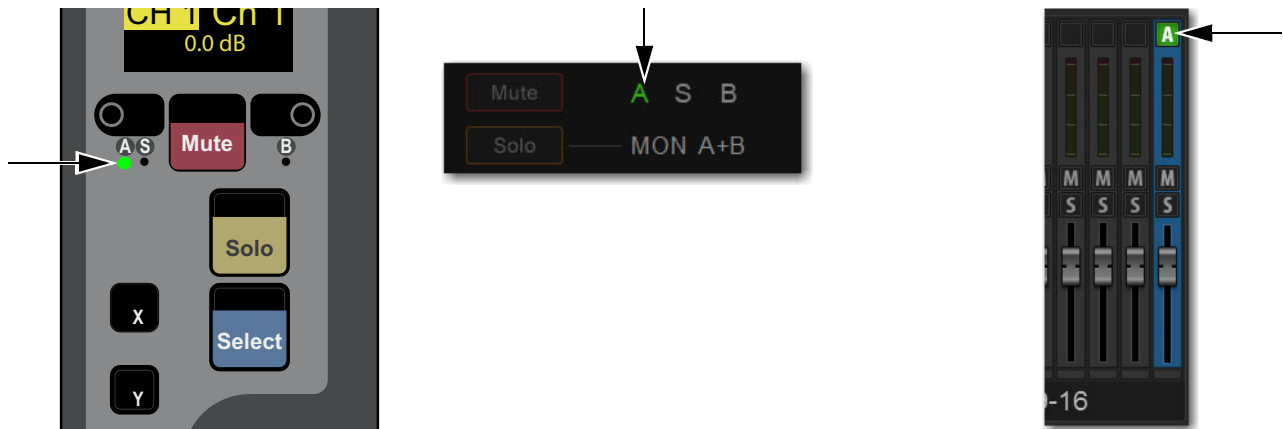

Indications that a channel is Automation Safed on the channel strip (left) the MTS/CTM Channel view (center) and on the external screen (right)

Automation Safing Using the Channel Knob Module (CKM)

To Automation Safe a channel using the CKM:

- 1 Bank the desired channel to the faders.
- 2 Press the **Select** switch for the channel you want to Automation Safe so it lights, then press the **INPUT** Channel Control Function switch so it lights.

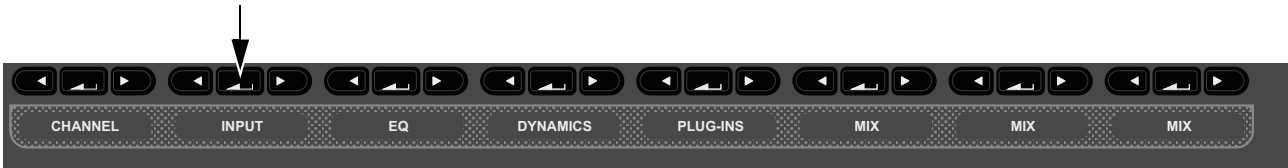

CKM Channel Control Function Switches

– or –

- Touch the channel's Input touch zone on the associated Channel Touch Module (CTM).



Input touch zone on the CTM in Meters view (left) and in Channel view (right)

Input parameters are assigned to the associated CKM.

- 3 Locate the Automation Safe encoder, indicated by Auto Sf on the encoder display, and press the encoder. The encoder **In** switch lights green, and the channel is Automation Safed.



Automation Safe parameter on a CKM encoder

Automation Safing Using the Channel Menu

You can Automation Safe a channel using the Channel Menu when a different Safe mode (such as Bank and/or Solo Safe) is enabled for the Channel Safe switches.

To Automation Safe a channel using the Channel Menu:

- 1 Bank the desired channel to the faders.
- 2 Press the **Menu** switch for the channel you want to Automation Safe until **Safe Mode** appears in the channel display. The Safe modes enabled by the Left and Right Channel Menu switches are shown below **Safe Mode**.
- 3 Press the Left Channel Menu Switch so it lights to Automation Safe the channel. The **A** LED lights green.

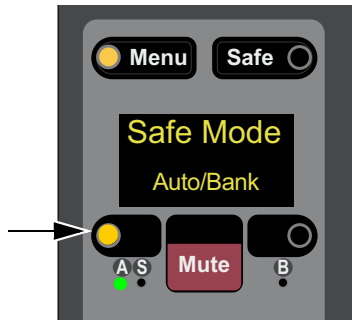

Right Channel Menu switch engaged

Snapshot Data Types and Parameters

Table 5. Snapshot data types and parameters included in each data type

Snapshot Data Type	Included Parameters (for Each Scoped Channel Strip)
Fader	Main volume level
Mute	Mute state for explicitly muted channels, and channels muted via VCA mute (Mute Group state is not snapshottable)
EQ	EQ type selection (analog/digital); EQ in-circuit state; Band gain, freq, Q, bell/shelf selection (digital only), band on/off
Dyn	Compressor/Limiter in-circuit state; threshold, ratio, attack, release, knee, makeup gain Expander/Gate in-circuit state; threshold, ratio, attack, release, hold time, range, side-chain input
Pan	Channel pan or balance/width Pan or balance/width for each Group bus returning back to L–R
Bus	Group bus assignments, group bus mono/stereo-linked state (if mono groups) or dual-mono/true stereo state (if stereo groups), L–R bus assignment and C/M bus assignments for input strips and groups
In	Input routing for input channels.
Out	Main out assignments; direct out assignments, level, in-circuit state, & tap-off point (excluding VCAs)
H/W	Hardware Insert routing and in-circuit state (excluding VCAs)
VCA	VCA membership
Pre	Gain, pad, phase, phantom power, HPF corner frequency & in-circuit state
Name	Name for each strip
MTX	Mixer Input Sources, User Input Assignments, and pickoffs; Mixer Input level, Mixer Input on/off and Mixer Input Link state
LAYT	User Layout
Aux Mon	On/off, pre/post selection, level, and pan/balance for each Aux bus classified as a Monitor Aux
Aux FX	On/off, pre/post selection, level, and pan/balance for each Aux bus classified as an FX Aux
AUX USR	On/off, pre/post selection, level, and pan/balance for each Aux bus enabled in the User Aux grid
Dly	Channel delay time & in-circuit
MIDI	All MIDI messages that were added to the associated MIDI list for that snapshot.
Plug-Ins	Rack slot settings, in-circuit state, and I/O routing for each plug-in added to plug-ins list for that snapshot

Patchbay

The Patchbay is used to assign Input and Output Channels, Direct Outputs, and Inserts to hardware inputs and outputs. The Patchbay also provides the ability to name input and output channels and to export your patchlist.

Accessing the Patchbay

To show the Patchbay screen:

- Select the Patchbay button on the external screen.

To jump to the Patchbay from the Inputs and Outputs screens:

- Select the channel routing indicator, right below the channel name display. The screen automatically jumps to the corresponding Patchbay screen (whether an input, output, or bus).

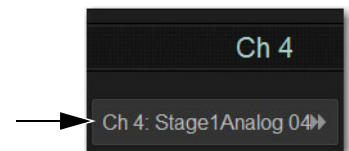

Overview of the Patchbay

The Patchbay screen lets you patch hardware I/O to input and output channels, and consists of the following tabs and controls:

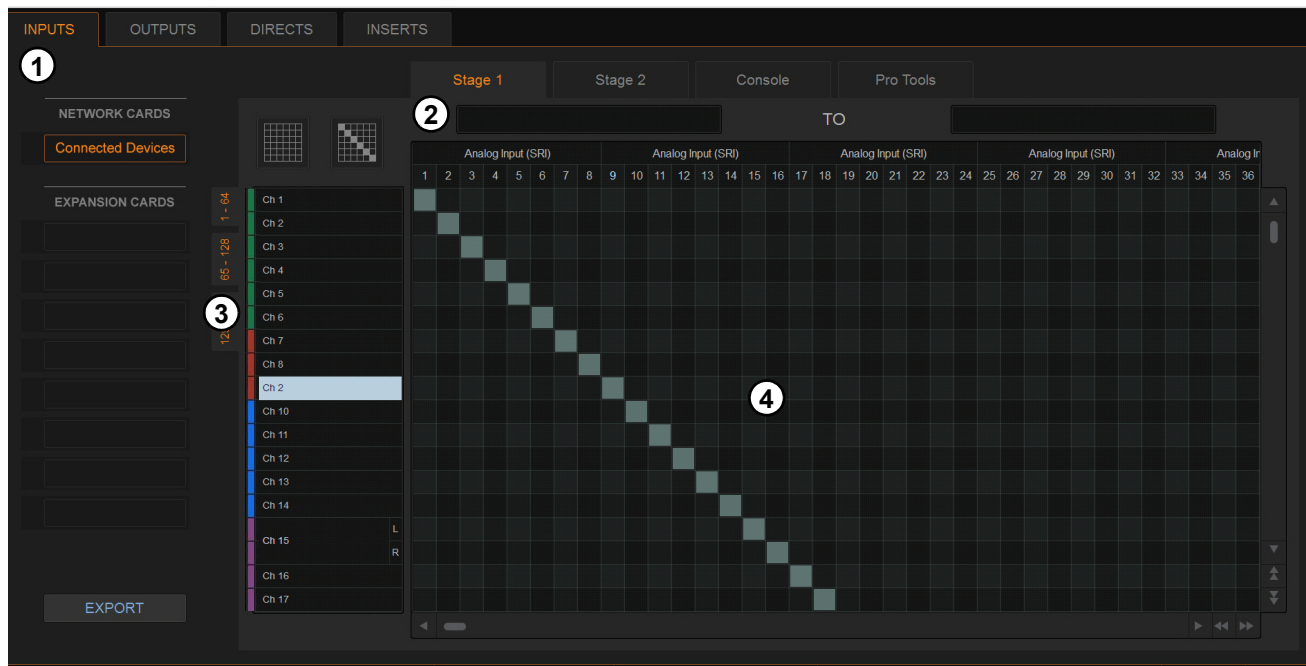

Patchbay page (Inputs tab shown)

1 – I/O Tabs

3 – Channel Type Tabs

2 – Hardware Tabs

4 – Patching Grid

I/O Tabs

Select these tabs to display and patch Inputs, Outputs, Directs (Direct Outputs), or Inserts. Other options in the Patchbay screen change to reflect the currently selected I/O tab.

 *The Inserts tab lets you patch hardware inserts on input and output channels. See [Hardware Inserts](#) for more information.*

Hardware Tabs

Select these tabs to display the hardware inputs and outputs available for the current I/O and Channel Type. These tabs represent the physical inputs and outputs of the system, as follows:

Hardware Tabs	Hardware Inputs	Hardware Outputs
Stage (1–6)	Stage I/O unit analog and digital inputs	Stage I/O unit analog and digital outputs
Console	S6L control surface analog and digital inputs, and the built-in oscillator.	S6L control surface analog and digital outputs
Local (1–2)	Local 16 analog and digital inputs	Local 16 analog and digital outputs
Pro Tools	Assignable Ethernet AVB Inputs from Pro Tools (see S6L Live Recording Guide.pdf for more information).	Assignable Ethernet AVB outputs to Pro Tools (see S6L Live Recording Guide.pdf for more information).

Available hardware inputs and outputs are based on channel type selection, system configuration and hardware device status. See [Unavailable I/O](#).

Channel Type Tabs

Select these tabs to select and display specific types of channels, as available for the currently selected I/O. The following table shows the available Channel Types for the current I/O.

I/O Tab	Channel Types available
Inputs	Input channels
Outputs	Mains, MTX (Matrixes), Auxes, Groups
Directs	Input and Output Channels
Inserts	Input and output channels.

Network and Expansion Cards

Select items under Network Cards or Expansion Cards to select and display channels for the corresponding IO devices.

Network Cards (Connected Devices) Displays I/O available on connected Stage 64s (such as SRI, SRO, DSI, DSO, or DNT-192 Dante cards).

Expansion Cards Displays I/O available on E6L option cards, if any, such as MADI-192 MADI Option cards.

Patching Grid

The patching grid shows hardware I/O across the top, and system channels (with colors) down the left side. The available channel tabs and choices are determined by the currently selected I/O tab and Channel type(s). The grid squares represent patch points between hardware I/O and VENUE mixing channels.

Navigating the Patching Grid

To scroll through the channel list (vertically):

- Select a channel name at the left of the patching grid, then press the Up or Down Arrow keys on the keyboard.

To scroll through the hardware I/O list (horizontally):

- Select a hardware I/O channel at the top of the patching grid, then press the Left or Right Arrow keys on the keyboard.

To scroll the patching grid, do one of the following:

- Select the up/down or left/right patching grid scroll arrows to move square by square.
- Select the up or down patching grid double arrows to move screen by screen.
- Touch and hold in the patching grid and drag in any direction.

Navigating to Channel Types

The Patchbay uses multiple tabs to access different hardware I/O and channel types in the patching grid. For example, the Outputs tab provides sub-tabs of output channel types for you to patch these different outputs independently.

Examples

To show output channels:

- Go to the Patchbay page and select the Outputs tab.

To show a specific type of output in the patching grid:

- In the Patchbay page, select the MAINS, MTX (Matrix), GRP, or AUX tabs. Press and hold Shift, then select multiple tabs to show multiple types at once.
- To show Stage 64 I/O, select Connected Devices (below NETWORK CARDS). To show E6L I/O (such as MADI-192 MADI Option cards, if any), select MADI-192 below EXPANSION CARDS.

To navigate to a different hardware source:

- Select the appropriate hardware tab across the top of the patching grid.

Visual Indicators and Displays

The Patchbay uses the following visual display conventions in all its tabs and pages.

Available I/O

When I/O is available for patching, the patching grid for the corresponding I/O lights.

Patched I/O

When a hardware connection is patched, its connection is dimmed in all Patchbay screens. This lets you see which hardware connections are in use without having to switch back and forth between Patchbay screens. You can also use the dimmed column number indicator to jump to the Patchbay page for the existing assignment (for more information, see [Shortcut for Locating Assignments](#)).

Unavailable I/O

The Patchbay displays hardware tabs for all possible configurations. For example, if your current configuration includes two Stage 64 I/O racks, three Stage tabs still appear in the Patchbay. Unavailable I/O for unconnected Stage 64 I/O racks and either unavailable or reserved Pro Tools I/O is indicated in the patching grid as follows:

Stage I/O Appears grayed out in the Patchbay under its corresponding hardware tab, and is italicized in all routing pop-up lists.

Pro Tools I/O When a Pro Tools computer is connected to the S6L control surface, system input channels with Stage inputs assigned to them are highlighted in purple under the Pro Tools hardware tabs in the Patchbay. This indicates that the Pro Tools I/O channels are reserved for use as direct digital splits to Pro Tools (outputs) or Virtual Soundcheck channels (inputs).



When a Pro Tools computer is not connected, all Pro Tools I/O is grayed out and unavailable in the Patchbay.

Shared I/O

The Patchbay indicates input and output ownership of Stage 64s and Stage 32s using colored text (see [IO Sharing Example](#)).

Patching Input Sources to Input Channels

You can patch inputs sources to input channels using the Patchbay on the external VENUE software screen.

 *Plug-in outputs can also be an input source. See [Routing Plug-Ins as Bus Processors \(Effect Send/Return\)](#).*

 *The S6L system comes pre-loaded with Demo show files, which offer preset system configurations for some of the most common mixing scenarios, including pre-patched inputs. See [Loading a Show](#) for instructions on loading Show files.*

To patch a single input source to an input channel:

- 1 On the external screen select Patchbay.
- 2 Select the Inputs tab.
- 3 To the left of the patching grid, select the range of input channels yo want to access in the patching grid.

 *Shift-touch any number of Channel Type and/or hardware tabs to select and display multiple tabs in the patching grid.*

- 4 Along the top of the patching grid, select a hardware tab to display hardware input sources.
- 5 Touch in the row for the channel and in the column for the hardware source. Grid squares light when channels are patched.



A lit grid square showing a hardware input source patched to an input channel

Channel source information is shown on-screen under the channel name on the external screen Inputs page, and on the MTS and CTM in Channel view. Channel source information is also shown on the control surface on the Channel Menu Source page in the channel display.

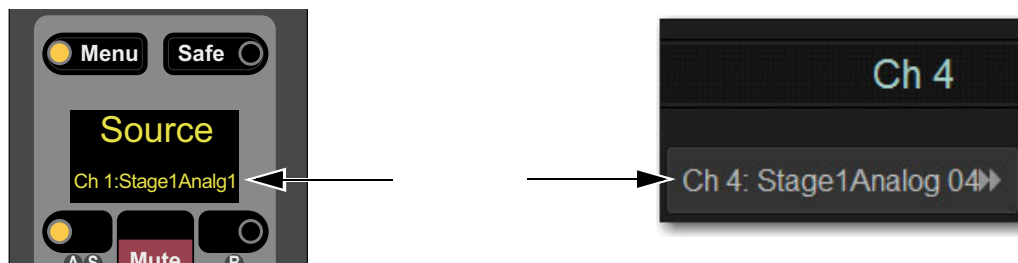

Channel Menu Source page (left) and Inputs page of the external screen (right)

To assign multiple channels in a single action, do either of the following:

- Touch, hold, and drag vertically, horizontally, or at an angle to assign multiple patch points in a single action.
- Select the Default Assignment button, and then select Assign in the confirmation dialog to assign all Stage inputs currently displayed in the channel grid to multiple consecutive input channels.

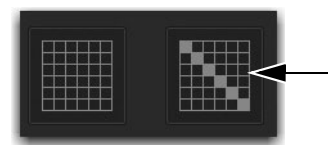

The Default Assignment button

Patching Output Channels to Hardware Outputs

Mains, Auxes, Groups and Matrix Mixer outputs can be assigned to any hardware output on the system using the Patchbay. In the Patchbay, each S6L system component has a corresponding hardware tab that displays the available hardware output destinations, as follows:

Hardware Tabs	Component Hardware Outputs
Stage 1–6	Stage I/O unit analog and digital outputs
Console	S6L control surface analog and digital outputs
Pro Tools	Assignable Ethernet AVB outputs to Pro Tools (see the S6L Live Recording Guide.pdf for more information).

To assign an output channel to a hardware output from the Patchbay:

- 1 Go to the Patchbay and select the Outputs tab.
- 2 To the left of the channel grid, select the Mains, Mtx (Matrix), Grp (Groups), or Aux tab to display those output channels in the grid.
- 3 Along the top of the channel grid, select a hardware tab to display available hardware output destinations.
- 4 Touch in the row for the channel and in the column for the hardware destination. Grid squares light when channels are patched.

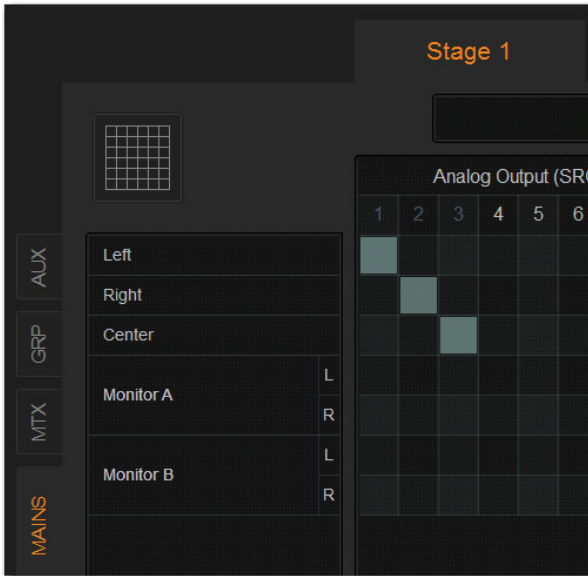

Mains patched to a Stage 64 hardware output

Channel destination information is shown on-screen under the channel name on the external screen **Outputs** page, and on the MTS and CTM in Channel view. Channel destination information is also shown on the control surface on the Channel Menu Destination page in the channel display.

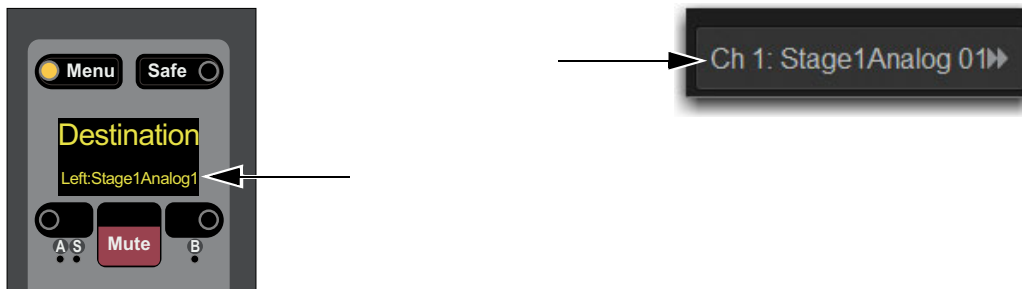

Channel Menu Source page (left) and Inputs page of the external screen (right)

Patching Direct Outputs

Direct Outputs of input channels, Auxes, Groups, Matrix Mixer, and Mains outputs can be assigned to any hardware output or Pro Tools output using the Patchbay Directs tab. Each hardware output destination may be fed by only one Direct Output signal (multiple Direct Output signals cannot be routed to a single output). You can choose the pickoff point for each channel's Direct Out.

To assign a channel to a Direct Output:

- 1 Go to the Patchbay page and select the Directs tab.
- 2 To the left of the channel grid, select the Mains, Mtx (Matrix), Grp (Groups), or Aux tab to display those output channels in the grid.
- 3 Along the top of the channel grid, select a hardware tab to display available hardware output destinations.
- 4 Touch in the row for the channel and in the column for the hardware destination. Grid squares light when channels are patched.

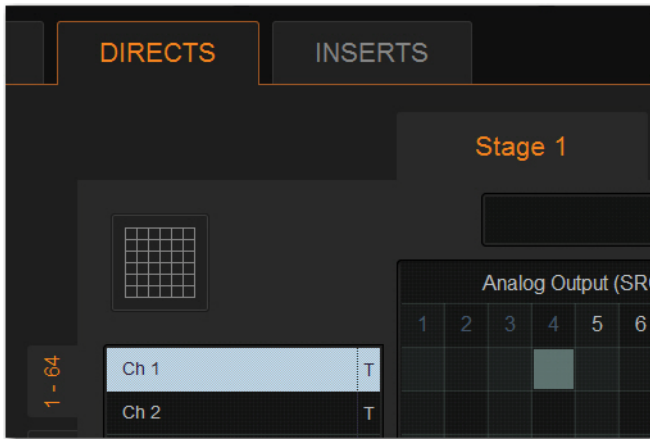

Assigning a Direct Output in the Patchbay

- 5 Select the pickoff point for the Direct Output by selecting the letter to the right of the channel and choosing from the pop-up menu. See [Direct Output Pickoff Points](#).

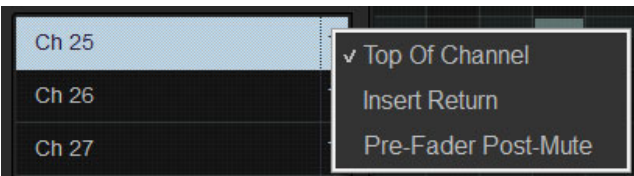

Selecting a Direct Output pickoff point in the Patchbay

Direct Output Pickoff Points

The “pickoff point” is the point in the signal path where the audio signal is picked off the main signal and sent to the Direct Output. The pickoff points for Direct Output signals are selected in the Directs tab of the Patchbay page. The following pickoff points are available for each type of channel or bus:

Pickoffs for Direct Outs

Channel Type	Available Pickoff Points
Input-channels	Top of channel Insert return Pre-Fader, or Post-Fader (configured globally in Options > Pickoffs)
Output channels	Top of <bus> Pre-Fader Post-Mute Post-Fader

Pickoff points for input channels are configured as pre-or post-fader globally.

Configuring Input Channel Pre-or Post-Fader Pickoff Points

Pickoff points for input channels are configured as pre-or post-fader globally.

To configure the Direct Output pickoff point for Inputs:

- 1 Go to the Options page and select the Pickoffs tab.
- 2 Under Input Channel Fader Pickoff Point, select Pre-Fader or Post-Fader.

Unpatching and Clearing Assignments

To unpatch a single channel in the Patchbay:

- Touch a lit square in the patching grid corresponding the channel you want to unpatch

To clear Patchbay Assignments:

- 1 Select the appropriate I/O tab, Channel Type tab, and Hardware tab.



To clear all Input, Output, Direct, or Insert assignments, press and hold Shift, then select all Channel Type and Hardware tabs to select all pages.

- 2 In the top left corner of the patching grid, select the Clear Assignments button, and select Clear in the ensuing dialog. All Patchbay assignments for the selected Patchbay pages are cleared.

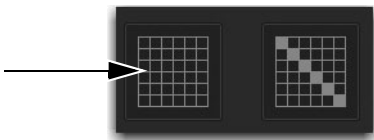

The Clear Assignment button

- 3 Repeat for other types of I/O as necessary.

Multiple Input and Output Patching

A single hardware input source can be patched to multiple input channels in the Patchbay. An output bus can be patched to multiple hardware outputs.

⚠ *Multiple input sources cannot be assigned to a single input channel.*

To assign a hardware input source to multiple input channels:

- 1 Go to the Patchbay page and select the Inputs tab.
- 2 Patch the input source for the first input channel.
- 3 Select additional grid squares in the same column to assign the source to additional channels so they are lit. The selected hardware input is patched to each of the assigned input channels.

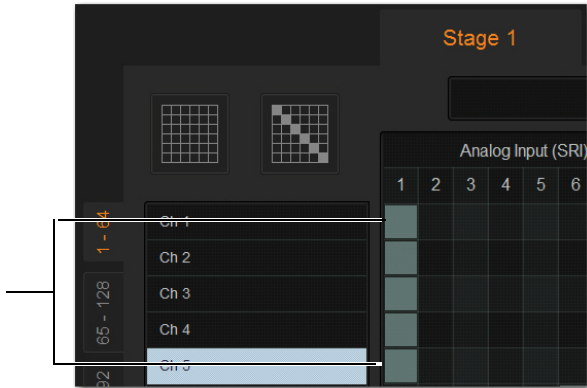

A hardware input routed to multiple input channels

To patch an Output bus to multiple hardware outputs:

- 1 Go the appropriate Patchbay page and select the Output tab.
- 2 Patch assign the desired output channel to the first hardware output.
- 3 Select additional grid squares in the same row to assign the same output channel to additional hardware outputs. The selected output channel is assigned to all the assigned hardware outputs. An asterisk (*) appears at the end of the displayed destination to indicate the multiple routing.

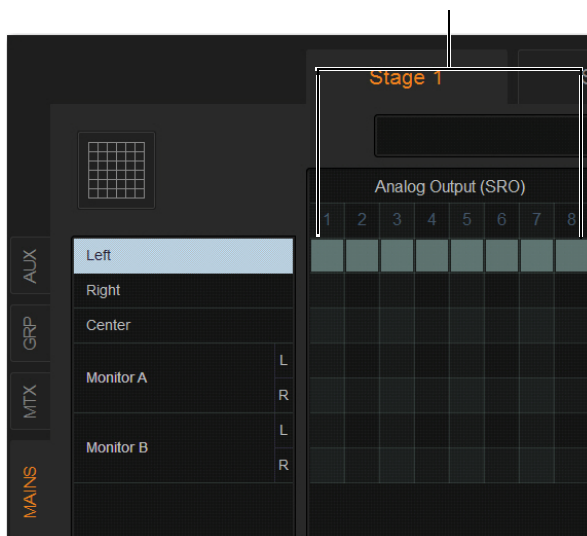

Mains Left patched to multiple hardware outputs

Warning When Stealing Inputs or Outputs in the Patchbay

The Patchbay indicates hardware outputs that are already in use by dimming the column number for that physical output. In addition, a dialog is shown if the patch will steal a hardware input *or* output that is already in use, asking you to confirm or cancel the reassignment.

 *If you repatch a hardware input to a different channel, Input gain, pad and phantom power move with the hardware input, replacing those settings on the destination channel. This occurs when repatching manually (in the Patchbay) or via a snapshot.*

To confirm a reassignment, do one of the following:

- Select Assign when prompted to confirm the reassignment.
 - or –
- Select again on the same patch point.

To cancel a reassignment, do either of the following:

- Select Cancel to leave the patchpoint unchanged.
- Select any other point in the grid (the Patchbay grid remains active, even when the Confirm Assignment dialog is open on-screen).

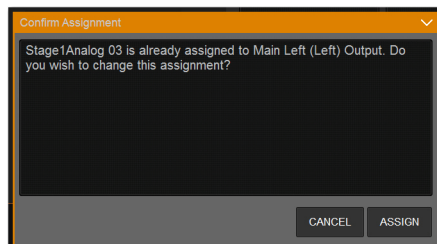

Warning when reassigning an output that is already in use

 *To suppress the reassignment warning dialog, hold Default (on the S6L control surface) or Alt (keyboard) while selecting in the patch grid to change the assignment.*

Shortcut for Locating Assignments

Before reassigning in the Patchbay, you may want to double-check the existing assignment to the desired hardware output. This can be done quickly from within the Patchbay.

To identify the bus or channels currently assigned to a hardware output:

- Select any dimmed (already assigned) column number at the top of the Patchbay. The Outputs page containing the assignment is automatically revealed in the patching grid.

Naming Channels from the Patchbay

Channel names can be changed from the Patchbay. Channel names can be up to 32 characters in length. When shown in the displays on the S6L control surface, channel names are abbreviated to fit the displays.

To name or rename a channel from the Patchbay:

- 1 Double-tap the channel name at the top of the screen or in the column of the grid.
- 2 Type a new name and press Enter on the computer keyboard.

 *When naming channels from the columns of the grid, press Tab on the keyboard to go to the next channel; press and hold the Shift key and Tab to go to the previous channel.*

Type Text Search

Type Text search lets you use the keyboard for fast navigation to a channel. You can enter the first characters of a channel name or the absolute channel number to target that channel.

To search for and select a channel:

- 1 Type the first few letters, full name, or channel number of the channel. For example, type “s” to go to the first channel beginning with the letter *s* (such as *Snare*).
- 2 Press the Tab key to cycle through and select any other channels beginning with that letter (such as *Snare Top*, *Snare Bottom*, or *Strings*).

 *Avoid giving channels names that begin with numbers different from the absolute channel number. When you type a number, VENUE navigates to absolute channel numbers regardless of the channel name.*

Patch List Export

The Patchbay Export generates a patch list in an easily readable format.

To export Patchbay information:

- 1 Insert a USB storage device into any USB port on the S6L control surface.
- 2 Go to the Patchbay page and select the Export button.

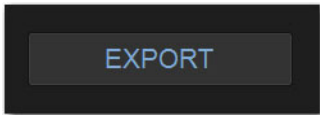

Patchbay Export Information button

- 3 Do any of the following:
 - If you have more than one USB device connected, make sure the correct USB one is selected. If it is not, select **Next Disk** to cycle through until the correct one is selected.
 - Select **Save** to export info to the selected USB device (or select **Cancel** to dismiss the dialog without exporting).
- 4 Select **OK** to confirm the export procedure. You can now remove the USB device and transfer the exported file to a personal computer for printing, formatting, and distribution.

 *When exporting a Patch list from the Standalone software, the generated HTML file is automatically opened using your default Internet browser (such as Internet Explorer, Mozilla Firefox or other).*

Contents of Exported Patchbay Information

Exported Patchbay information is saved as an HTML file, and the file name includes the date and time of the export. Contents include the following:

VENUE Patch List

Show Name, file path, date and time of Show file.

Input and Output Patching (Stage, Console, and Pro Tools)

Stage I/O Hardware input and output numbers and the channel numbers or names are shown for each Stage I/O unit.

Console I/O Hardware input/output types and numbers, and channel patch are shown.

Local I/O Hardware input/output types and numbers, and channel patch are shown for each Local 16.

Pro Tools I/O Pro Tools input and output channel numbers and channel patch are shown.

- Unavailable channels are labeled N/A.
- Direct outs are identified uniquely.

Plug-Ins

This chapter explains how to configure plug-ins before a performance, and how to use plug-ins during a performance. Plug-Ins can be inserted on all channels and bus outputs, or used as bus processors for effects such as reverb and delay.

 *S6L systems support 64-bit AAX DSP plug-ins only. For complete information on S6L-compatible plug-ins, visit the Avid website (www.avid.com).*

When a [WSG-HD Waves SoundGrid Option Card and Waves Plug-Ins](#) are installed in an E6L engine, Waves SoundGrid plug-ins can be integrated directly into your VENUE mixes just like other VENUE plug-ins.

Plug-Ins Quick Start

Before a performance, enable Config mode and do any of the following:

- Install plug-ins (see [Installing and Authorizing Plug-Ins](#)).
- Assign plug-ins to racks and rack slots (see [Plug-In Racks](#)).
- Assign plug-in input and output routing, including sidechain routing (see [Routing Plug-Ins](#)).
- View and adjust plug-ins from the S6L control surface or on-screen (see [Adjusting Plug-Ins on the External Screen](#)).
- Save and load plug-in settings as Presets, or with snapshots (see [Plug-In Presets and Snapshots](#)).

During a performance, do all of the following:

- Enable Show mode to “safe” (lock out) plug-in rack assignments and other plug-in rack operations that could interrupt a performance.
- Patch channels and buses to available plug-ins, re-assign plug-in routing, or re-assign existing side-chain routing.
- Adjust plug-in parameters from Channel Control, Global Control, or on-screen.
- Save and load plug-in settings as Presets, or within snapshots.

Using Config and Show Modes for Plug-Ins

The current system mode status (Config or Show mode) determines which plug-in functions are available.

Config mode is required to install plug-ins, assign them to rack slots, and to establish side-chain routing. When in Show mode, any operations that might interrupt audio throughput are locked out and unavailable.

 *Plug-In actions that interrupt audio require Config mode. For more information, see [Enabling Config Mode](#).*

Installing and Authorizing Plug-Ins

Plug-Ins are installed on your system using a USB drive. Plug-in installers are transferred to your USB drive, then installed on the S6L control surface. For Waves plug-ins, see

⚠ *Because installing plug-ins can interrupt audio throughput, always install plug-ins before a performance.*

Transferring Plug-In Installers to USB

To transfer plug-in installers to a USB drive:

- 1 Make sure there is enough free space on the USB drive to accommodate all the software.
- 2 Unzip the downloaded software by doing the following, depending on your computer platform:

Mac Double-click the ZIP file containing the software to unzip it.

Windows Right-click the ZIP file containing the software, select Extract All... from the pop-up menu, and in the ensuing dialog click Extract.

- 3 In the unzipped files, locate the “AAX Plug-Ins” folder.
- 4 Copy the entire “AAX Plug-Ins” folder to the top (root) level of the USB drive.

Installing Plug-Ins

To install a plug-in:

- 1 Put the system into Config mode.
- 2 Insert the USB drive containing the plug-in installer(s) into an available USB port on the S6L control surface.

⚠ *Plug-Ins cannot be installed using the USB ports on the E6L engine.*

- 3 On the external VENUE software screen, go to the Options page and select the Plug-Ins tab. The following two lists are shown:

Plug-Ins to Install This list shows available plug-in installers. At the top of the list is the Device selector, which provides a pop-up menu of available media sources. Plug-In installers are stored locally after plug-in installation, and appear as available items when Previous Installs is selected from the Device selector. This lets you re-install plug-ins without the original plug-in installer.

Installed Plug-Ins This list shows all plug-ins already installed on the system. The plug-ins shown in plain text are available to process audio. Plug-Ins listed in italics are disabled and unavailable (see [Enabling and Disabling Installed Plug-Ins](#)).

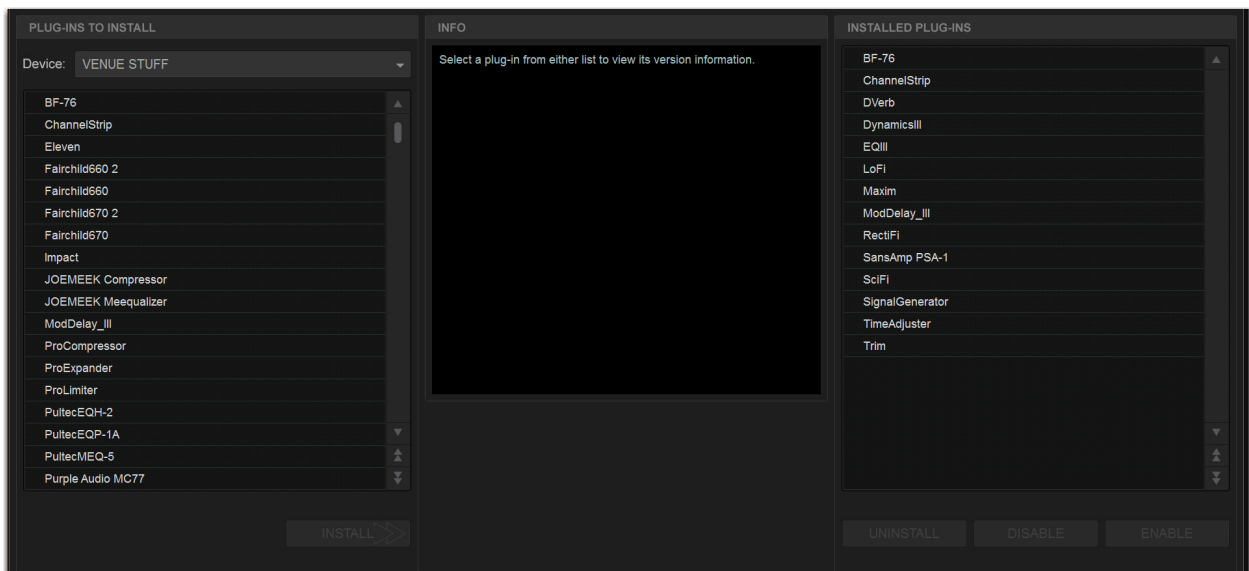

Options > Plug-Ins screen

- 4 In the Plug-Ins to Install list, select the device selector pop-up menu and do one of the following:
 - Choose **Previous Installs** to access any plug-in installers after a system update.
 - Choose **Console** to access all factory-installed plug-in installers after a system update or a full system restore.
 - Choose an external storage device, as available, to access plug-in installers on drives connected to the S6L control surface.

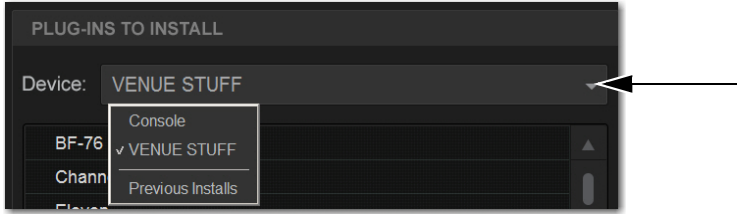

Device selector pop-up menu

- 5 Select a plug-in from the Plug-Ins to Install list on the left by doing any of the following:
 - Select a single installer so it is highlighted.
 - Shift-touch to select multiple consecutive installers.
 - Control-touch to select or deselect installers one at a time.
- 6 Select **Install** to install the selected plug.

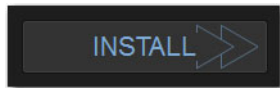

Plug-Ins Install button

- 7 When prompted, select **Accept** to accept the End User License Agreement (EULA) for the plug-in. The EULA for each plug-in installed must be during installation accepted.
Once installed, the plug-in appears in the Installed Plug-Ins list on the right.
- 8 Repeat as necessary to re-install all plug-ins needed on the system.

Uninstalling Plug-Ins

Uninstalling a plug-in removes the plug-in from the racks but the installer remains in the Previous Installs cache, making it easier to reinstall the plug-in at a later time without requiring the installer media.

The list of available plug-ins you see in VENUE software is updated automatically each time you load a Show file to keep plug-in lists and menus uncluttered (see [Automatically Removing Plug-ins During Show Load.](#))

You can also remove or delete plug-ins and/or their installers manually. In order to completely remove and delete a plug-in and its installer, you must explicitly delete the plug-in, as described in the following sections.

 *Installing, uninstalling, and deleting plug-ins are not supported using the Standalone software.*

To uninstall a plug-in from the system but leave its installer available:

- 1 Put the system in Config mode.
- 2 Go to Options > Plug-Ins.
- 3 Touch-and-hold (right-click) the specific plug-in name from the right-hand list and choose the **Uninstall** option for the selected plug-in.

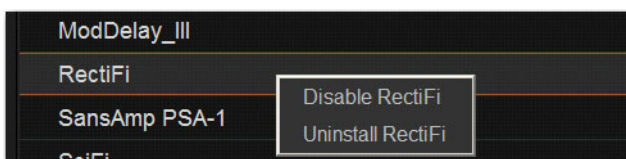

Disable/Uninstall plug-in menu

To reinstall a removed plug-in:

- 1 Put the system in Config mode.
- 2 Go to Options > Plug-Ins.
- 3 Select the Device selector and choose Previous Installs from the menu.
- 4 Select the plug-in and choose Install. If the desired plug-in is not listed, it must be re-installed from a USB drive containing its installer.

Deleting Uninstalled Plug-Ins

Once a plug-in is uninstalled, its installer can be deleted from the system. (Plug-ins which are currently installed cannot be deleted).

To completely remove a plug-in and its installer:

- 1 Put the system in Config mode.
- 2 Go to Options > Plug-Ins.
- 3 Select Previous Installs from the Device selector.
- 4 Touch-and-hold (right-click) the plug-in name and choose the Delete option for the selected plug-ins. The plug-in is removed from the system, and the stored plug-in installer is removed from the Previous Installs list.

Installing Plug-Ins Manually

If a plug-in does not appear in the Plug-Ins to Install list, it may not have a fully compatible VENUE installer and must be manually installed. This is required the first time you install the plug-in, and whenever you need to re-install a plug-in (such as after using the System Restore software to update or reset the system).



A plug-in without a VENUE installer may still be compatible. Consult the plug-in manufacturer for compatibility information.

To install a plug-in manually:

- 1 Make sure all sound systems are shut down or muted.
- 2 Insert the USB storage device with the plug-in installer into a USB port on the S6L control surface.
- 3 Go to the Options page and select the System tab.
- 4 Hold the Ctrl key and select Shutdown. Follow the on-screen directions to exit to the Desktop.
- 5 Copy the plug-in installer to the disk partition called User Data.
- 6 Launch the plug-in installer application and follow any on-screen directions. If prompted, do not restart the system from a plug-in installer. (Doing so will not harm the system, but will take longer, especially if you have multiple plug-ins to install manually.)
- 7 Quit the installer application and eject the installer disc.
- 8 Select the Return to VENUE shortcut on the desktop to re-launch the VENUE software.
- 9 Go to Options > Plug-Ins. Verify that the manually installed plug-in appears in the Console list of available plug-ins.

Authorizing Plug-Ins

A core set of plug-ins are installed on your system. These plug-ins do not require any authorization. Other plug-ins, such as the S6L plug-ins downloaded from your Avid account and paid plug-ins from Avid and our Development Partners, require authorization.

The S6L system supports iLok USB Smart Key authorization. Licenses that authorize the use of a plug-in are transferred from your iLok account to your iLok. This lets you take your iLok and your plug-in licenses anywhere, to use your plug-ins on any system.

After installing a plug-in, the system re-creates the list of available plug-ins. Whenever the racks initialize, the system checks for all installed plug-ins. If an iLok with a license for an installed plug-in is not connected to the S6L control surface, you will be prompted to try a demo version, or authorize the full version of the plug-in.

To authorize a plug-in:

- 1 When a plug-in authorization dialog appears, do one of the following:
 - To try a demo of the plug-in, select **Try**, where available.
 - or –
 - To have the system recognize the required license on your iLok, select **Authorize**. Insert your iLok into any available USB port on the S6L control surface when prompted.
- 2 Follow the instructions on-screen to complete the software authorization process.

Enabling and Disabling Installed Plug-Ins

The Installed Plug-Ins list shows Disabled plug-ins in *italics*. Plug-Ins can be manually disabled and enabled to manage DSP resources, troubleshoot possible conflicts, and to manage plug-in availability.

To globally disable or enable a plug-in:

- 1 Select the plug-in name in the Installed Plug-Ins list, at the right of the Options > Plug-Ins page.
- 2 Touch-and-hold (right-click) the plug-in and select whether to **disable** or **enable** the selected plug-in. If assigned to any rack slots, the plug-in will be displayed as unavailable and inactive.

Automatically Removing Plug-ins During Show Load

Plug-ins are verified during the Show file load procedure to streamline plug-in lists and menus by automatically removing unused plug-ins (plug-ins that were once installed but subsequently uninstalled or disabled).

In addition, the plug-in lists can be reset manually using the **Remove Unavailable Plug-ins** command. Plug-ins which are not available and not in use in the rack are automatically filtered from all plug-in menu lists when the show file is subsequently stored. This filtered list is stored with the Show file.

Plug-ins which are not available but *are* in use will remain in the rack and display a warning icon indicating the plug-in isn't installed or is disabled. Such plug-ins appear as italicized entries in the plug-ins menu lists.

Manually Removing Unavailable Plug-ins from the Racks

Unavailable plug-ins can be easily removed from rack slots using the **Remove Unavailable Plug-Ins** command.

To manually remove unavailable plug-ins:

- 1 Put the system in Config mode. Make sure the plug-in rack is fully initialized (the Status indicator displays OK).
- 2 Select the Plug-In Selector in any rack slot and choose **Remove Unavailable Plug-Ins**. This menu item is only available when one or more unavailable plug-ins are present in the rack (indicated by a warning symbol in the rack slot).
- 3 Select **Remove** to confirm the operation, or select **Cancel**.

If you proceed with the removal:

- All unavailable plug-ins are removed from the plug-ins rack.
- The italicized entries for unavailable plug-ins are removed from all plug-in menu lists.
- All references to unavailable plug-ins are removed from the Insert Processing section of all affected channels, and the insert point plug-in is set to **None**.
- All references to unavailable plug-ins are removed from all snapshots.

The new, updated list of available plug-ins is subsequently saved to the Show file.

History File and Removing Plug-ins

A History file is written immediately before removing unavailable plug-ins from the rack, in order to provide a means of undoing the operation.

Plug-in Version Checker

VENUE software includes a comprehensive database of plug-in information, and this info can be used to greatly simplify the process of managing your VENUE plug-ins.

Use this feature to get version details and compatibility information for a plug-in prior to installing, or after it has been installed to help diagnose or troubleshoot plug-in performance.

Version checking also warns you when you are about to downgrade a plug-in (install an older version over a newer version).

 *In addition to using the plug-in version checker, also check the VENUE plug-in tabs on the Avid website (www.avid.com) for the most up to date information*

To view plug-in version information:

- 1 Go to Options > Plug-Ins.
- 2 Select a plug-in from either list (Plug-Ins to Install, or Installed Plug-Ins).

 *Version information is not shown for a multi-selection. Select an individual plug-in to view its version information.*

The Info pane displays details about the currently selected plug-in, including whether a newer version of the plug-in is available. If a new version is available, you can find out whether it is a recommended update or a critical update. The following dialogs appear if you choose to install older plug-ins:

- If you choose to install a plug-in for which there is a critical or recommended update, a dialog appears asking you to confirm the installation procedure.
- A similar dialog appears when attempting to replace an installed plug-in with an older version of the same plug-in. Follow the instructions on-screen to install anyway, or cancel.

Using System Info to View Plug-in Version Information

Plug-in version information is included in exported System Info data.

The Plug-in sections of the exported System Info file show critical and recommended updates, with links to sites to download or check for newer versions.

To use System Info for Plug-In Version Maintenance:

- 1 Insert a USB storage device into any available USB port on the S6L control surface engine.
- 2 Go to Options > System.
- 3 Select the Info button.
- 4 Do any of the following:
 - If you have more than one USB device connected, make sure the correct USB device is selected. If it is not, select Next Disk to cycle through each available disk until the correct one is selected.
 - Select Save to proceed and export system info to the selected USB device.
 - Select Cancel to dismiss the dialog without exporting.
- 5 Select OK to confirm the export procedure.
- 6 Remove the USB device. Transfer the exported file to a personal computer for printing, formatting, archiving or distribution.
- 7 If viewing the System Info document from a computer with Internet access, use the included links to check for plug-in updates.

Plug-In Racks

The Plug-Ins page provides five plug-in racks. Each of the racks has slots into which you can load a plug-in. The different racks can be viewed all at once, individually, and in varying zoom levels. You populate the racks by *assigning* plug-ins in rack slots.

The number of racks and slots vary with different S6L systems.

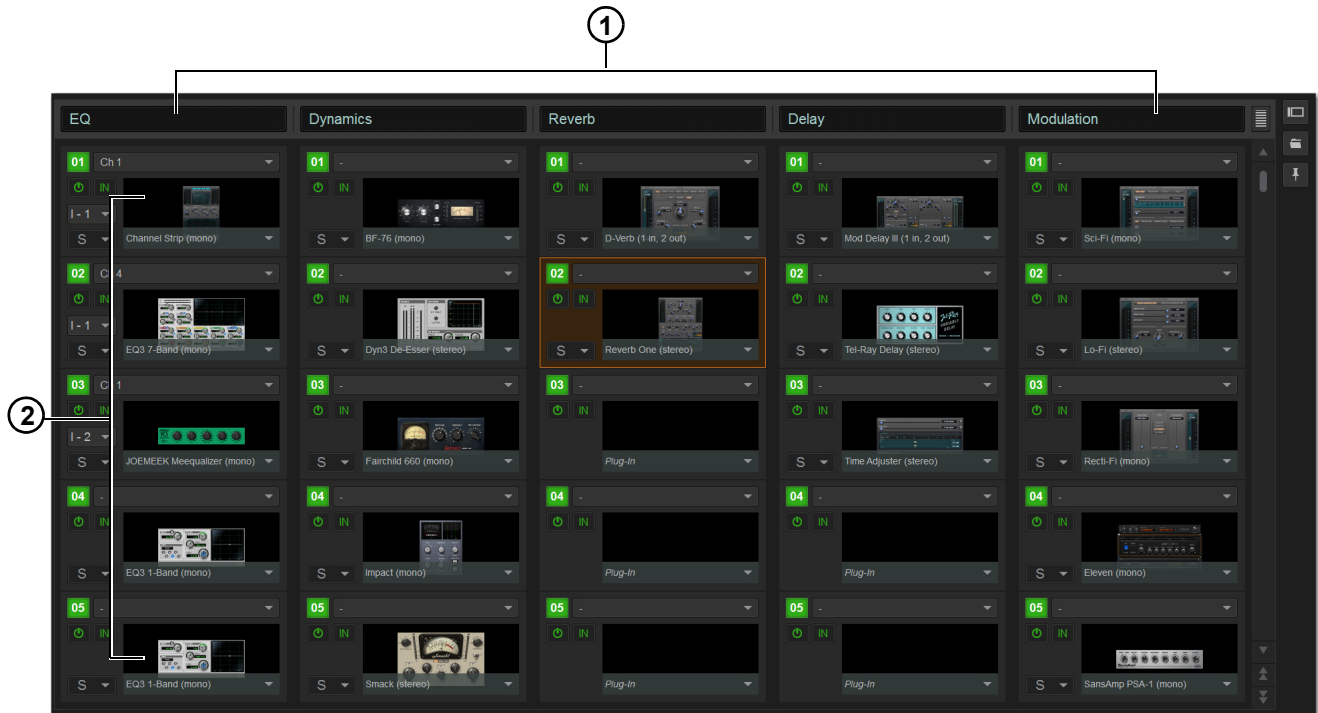

Plug-in racks (1) and rack slots (2), Full view, with custom rack names shown

Naming Plug-In Racks

You can name and rename each rack as needed.

To rename a plug-in rack:

- 1 Double-tap the rack name to highlight it on-screen.
- 2 Type a new name and press Enter. To return a rack to its default name, leave the name blank and press Enter.



Plug-Ins can be placed in any rack slot. Use the different racks to organize processing functions such as Dynamics, Vocal FX, Reverb, or Group Inserts.

Rack Views

The Plug-Ins page can be displayed in Full or Zoom views. Either view can show a Collapsed view of 10 rack slots.

Full View

The default view of the rack screen is Full view, in which five racks are shown at a time. This screen provides access to all rack slot controls and shows an icon representing each assigned plug-in. This lets you quickly see what plug-ins are available, and adjust their routing.

Zoom View (Plug-In View Mode)

In Zoom view, a single rack remains on-screen to the left, and the rest of the screen displays the targeted plug-in.



Zoom view, with a plug-in window open on-screen

To toggle Full or Zoom view modes, do one of the following:

- Select the View toggle switch (upper right corner of the rack).
 - or –
- Double-tap a plug-in icon in any rack view to open that plug-in window in Zoom view.

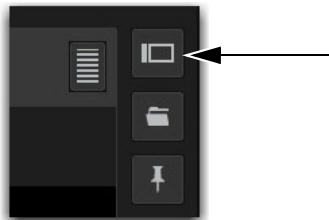

View toggle button

Collapsed View

You can collapse the plug-in racks so ten rack slots per row are shown in Full of Zoom view.

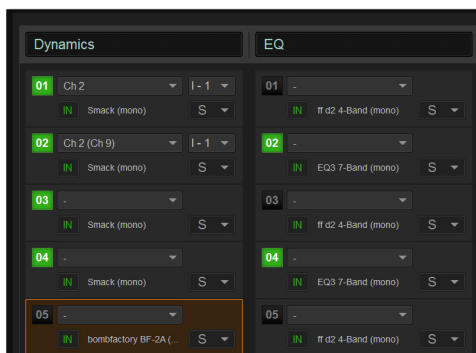

Full view, collapsed

To toggle between Expanded or Collapsed rack slot views:

- Select the Expand/Collapse button (upper right corner of the rack).

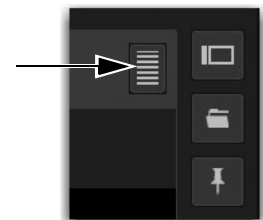

Plug-Ins

“Jump To” Plug-Ins

You can “jump to” a specific plug-in insert from the Input and Output pages to adjust it on-screen in the Zoom view of the Plug-In page.

To jump to a plug-in insert from the Inputs or Outputs screen:

- 1 Select a channel to display it in the Inputs or Outputs screen.
- 2 Select the plug-in name (or None if no plug-in is inserted in that slot) shown in the channel Inserts section.

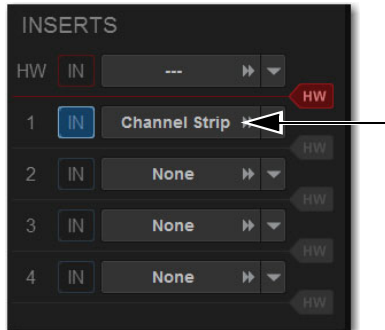

Jumping to a plug-in on a channel insert

To jump to a bus-fed plug-in:

- 1 Bank to the input channel the plug-in output is assigned to, or bank to the output feeding the plug-in.
- 2 Attention the channel to display it in the Inputs or Outputs screen.
- 3 Select the routing displayed beneath the Channel Name.

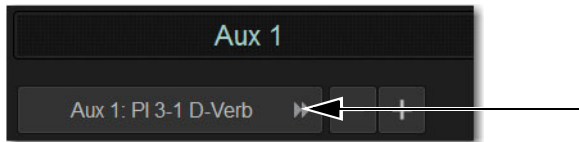

Jumping to a plug-in on a bus

Plug-Ins Screens and Channel Selection

When jumping to a plug-in, display depends on the type of plug-in routing, as follows:

Channel Inserts If the Plug-Ins screen is in Zoom view while you attention a channel, the last attentioned plug-in for that channel is automatically targeted and displayed in the Plug-Ins screen.

Bus-Fed Plug-Ins If no plug-ins are inserted on a channel (such as when returning a bus-fed plug-in to an input channel), the plug-in feeding that input channel is displayed.

Pinning a Plug-In View

You can decouple the plug-in view for consistent and constant access to a single plug-in on-screen, while still being able to select and adjust other plug-ins from the control surface. *Pinning* a plug-in view is useful any time you want to always display an important plug-in (such as an analysis plug-in or primary EQ).

To pin a plug-in view:

- 1 Bring the desired plug-in into the Zoom view (use the channel Select and Insert Mode switches, double-tap the desired plug-in from the rack, or jump to the plug-in from the Inputs or Outputs page).
- 2 Select the Push-Pin icon in the upper-right of the screen (the icon is located just to the left of the Presets and View Toggle icons).
 - When enabled, the Push-Pin icon appears lit. This indicates that the current plug-in will remain on-screen and will not lose focus, even if another channel is targeted.
 - When not enabled, the Push-Pin icon appears unlit. Plug-in view follows control surface selections.

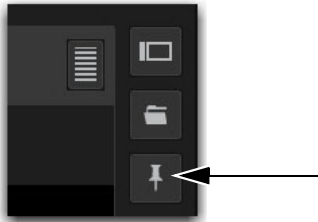

Push-Pin icon

Identifying Rack Slots

In the plug-in racks, the slot of the targeted plug-in is bordered in orange.

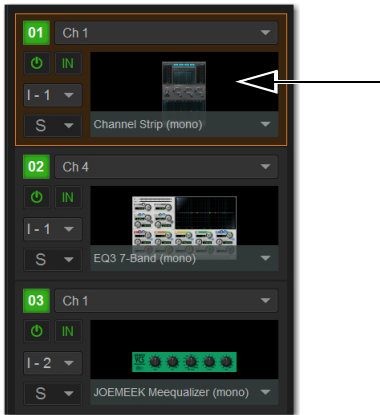

Targeted plug-in in a rack

Display of Unavailable or Inactive Plug-Ins

It is possible for a plug-in to be displayed in a rack slot but be unavailable for channel and bus processing. This can occur in any of the following circumstances:

- There are not enough DSP resources available for the plug-in.
- The assigned plug-in is part of the show file but is not installed on the current system.
- The plug-in has been disabled manually.

 To view DSP resource allocation, see [2 – HDX DSP](#).

Unavailable Plug-Ins

When a plug-in cannot be used because of insufficient DSP resources, because it is disabled, or because it is not installed on the system, a warning icon is shown in front of the affected plug-in. The plug-in icon is grayed out, and the rack slot Power switch displays a yellow switch LED.



Indication of an unavailable plug-in

For more information, see [Installing and Authorizing Plug-Ins](#).

Scope Indication in the Plug-Ins Page

The Plug-In Rack provides visual indication whenever a plug-in is scoped in the currently targeted snapshot. The Snapshot pop-up menu turns red whenever that plug-in is scoped by the currently targeted snapshot.

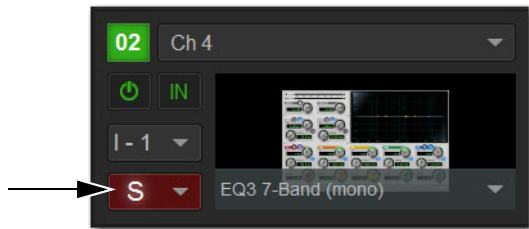

Indication of a scoped plug-in

For more information, see [Plug-In Presets and Snapshots](#).

Rack Slots

Each rack provides ten plug-in slots. You can assign any installed plug-in to any available rack slot.



A rack slot and its controls, with an assigned plug-in shown

Rack Slot Controls

Each rack slot provides the following controls to select and manage plug-ins:

1 – Power (Config Mode Only)

Power turns the rack slot on or off. When off, the plug-in consumes no DSP.

2 – In/Out (Bypass)

The In/Out switch takes the rack slot in or out of circuit (bypasses the slot and any plug-in assigned to it).

3 – Input Selector

The Input selector displays a menu of input sources for a plug-in. Use this to designate the plug-in as a channel insert or a bus processor by choosing from the Inserts or Bus sub-menus. For more information, see [Routing Plug-Ins](#).

Once a plug-in has been routed, its input source is displayed in the Input area of each rack slot, as follows:

- If the plug-in is being used as an insert, the channel or bus name and number is shown, for example, *Kick (Ch 1)* or *Aux (1–2)*. The Channel Insert/Bus Output selector automatically switches to Channel Insert mode, showing the insert point occupied by the plug-in.
- If the plug-in is on a bus, the selected bus source is shown in the Input selector, for example, *Aux 1* or *Grp 1*. The Channel Insert/Bus Output selector can be used to assign the output routing of the plug-in to a channel or bus.

4 – Channel Insert or Output Selector

The Channel Insert/Output selector displays different choices depending on whether the plug-in is being used as a channel insert, or as a bus processor, as follows:

- If the plug-in is being used as a channel insert, the Channel Insert Selector shows the four insert points on that channel (1–4). The letter “I” is shown before the insert number (for example, I-1 indicates the current plug-in is inserted into the first insert position on its channel).
- If the plug-in is being used as a bus processor, the selector is an Output selector, used to select the destination for plug-in output. When the plug-in is routed, the selector shows the channel to which the plug-in output is assigned.

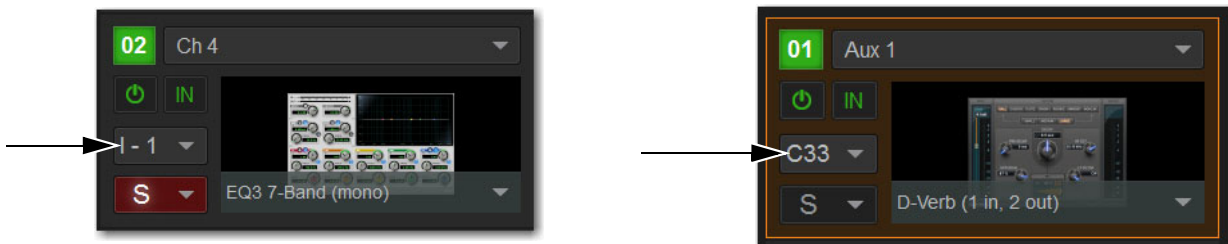

A rack slot shown an inserted mono plug-in (left) and a stereo plug-in assigned as a bus processor (right)

5 – Plug-In Selector

The Plug-In selector displays a list of available plug-ins to load into that rack slot. Plug-Ins are arranged by process type (such as EQ, Dynamics, and Delay). For more information, see [Routing Plug-Ins](#).

6 – Snapshots Menu

The Snapshots menu provides tools to manage snapshot-related plug-in features from within the Plug-Ins screen. Using the Snapshots menu, you can quickly check to see which existing snapshots refer to the current plug-in, as well as create, update, or remove snapshots.

Sidechain Selector

The Sidechain selector appears near the top of the Zoom view when you select a plug-in that supports side-chain or “key” input. In Config mode, the Sidechain selector lets you establish a side-chain routing to the plug-in. Once established, you can route and re-route side-chain signals in both Config and Show mode. For more information about side-chain signals, see [Sidechain Routing](#).

Assigning Plug-Ins to Rack Slots

Before a plug-in can be used to process audio, it must be assigned to a rack slot. Once assigned, you can use the plug-in as a channel insert or bus processor.

 Before a plug-in can be assigned, it must be installed. See [Installing and Authorizing Plug-Ins](#).

To assign a plug-in:

- 1 Put the system into Config mode.
- 2 Go to the Plug-Ins page.
- 3 Select the Plug-In Selector on an empty rack slot. (You can also use an already assigned rack slot to change a plug-in assignment.)

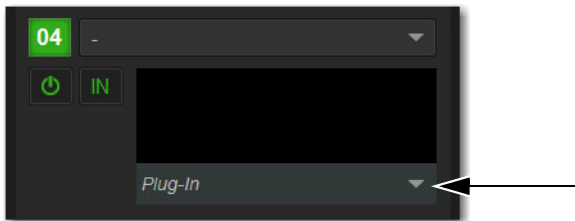

The Plug-In selector

- 4 Choose an available plug-in from the Plug-In selector sub-menus. Only plug-ins that are installed will be available.

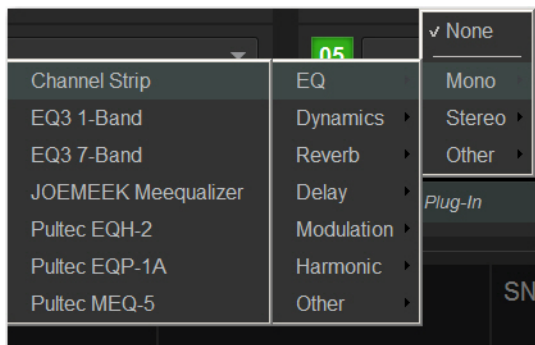

Plug-In selector menus

If the plug-in is not installed or there are insufficient DSP resources available, the plug-in will appear as unavailable, or inactive.

 Place the cursor over the plug-in to display a Tool Tip that explains why the plug-in is unavailable or inactive.

Plug-In Formats (Mono/Stereo)

Plug-Ins inserted on input channels must be symmetrical (in other words, mono in/out or stereo in/out). Plug-Ins on buses can be asymmetrical (mono-in/stereo or multichannel out).

Mono Can be used as inserts only in mono strips or mono Auxes, mono Groups, or Matrix buses or on the C/M bus.

Stereo Can be used as inserts in stereo strips, stereo-linked Auxes, and stereo Groups.

Other (Mono In/Stereo Out) Can be used on buses for delay, reverb, and similar processing.

Moving and Copying Plug-Ins

(Config Mode Only)

To move or copy a plug-in from the rack, drag the plug-in icon to a new rack slot. A pop-up menu appears offering two choices: Copy Plug-In Here, or Move Plug-In Here.

Moving a Plug-In

When you move a plug-in from one rack slot to another, the plug-in type, in/out state, power on/off, current plug-in settings, and routing are maintained. In addition, all associated snapshots are updated to reflect the new rack position.

Copying a Plug-In

When you copy a plug-in to a new rack slot, the source plug-in type, in-circuit state, active state, and current plug-in settings are copied to the destination rack slot. However, the source plug-in routing is not copied. In addition, plug-in snapshots are not copied.

Overwriting An Existing Plug-In

When either moving or copying, if there is an existing plug-in located in the destination rack slot, that plug-in is deleted. When the plug-in located in the destination rack is deleted, any routing or references in existing snapshots to the deleted plug-in will be automatically cleared.

Activating and Deactivating Plug-Ins

To activate and deactivate a plug-in:

- Select the appropriate rack slot Power switch. When active, the Power switch lights green. When a plug-in is unavailable (and inactive), the Power switch lights yellow.



Rack slot power switch

Routing Plug-Ins

After a plug-in has been assigned to a rack slot, you can specify its routing. Plug-In routing determines whether the plug-in is used as a channel insert or as a bus processor.

Inserting Plug-Ins on Channels

Four slots per channel are provided for plug-in inserts. Signal from the channel is routed to the insert and returned to the same channel. You can assign plug-ins to specific channel insert points from the Plug-Ins screen or from the Input screen.

To insert a plug-in on a channel from the Inputs or Outputs page:

- 1 Go to the Inputs or Outputs page.
- 2 Select the first available Inserts slot selector.



The Inserts selector

- 3 Choose an available plug-in from the rack sub-menus. All currently available plug-ins of a compatible mono/stereo format are listed in the sub-menus. Plug-Ins that are unavailable are listed in italics. Plug-Ins that are currently inserted on other channels are shown with their insert assignment.

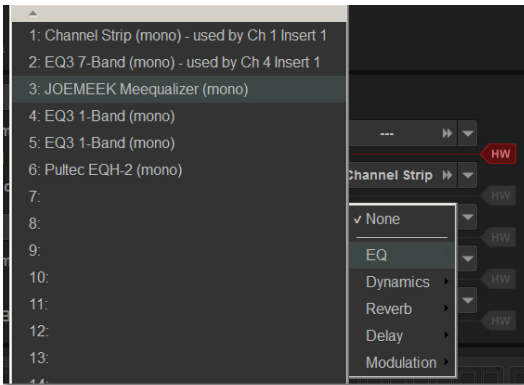

Plug-in rack sub-menus

- 4 The plug-in appears in the Inserts list for that channel.

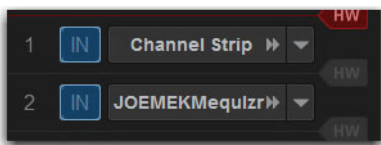

An assigned channel insert

- 5 To open the window for an inserted plug-in, select its name in the channel Inserts list.

To insert a plug-in on a channel from the Plug-Ins page:

- 1 Make sure the plug-in is already assigned to a rack slot. (See [Assigning Plug-Ins to Rack Slots.](#))
- 2 In the rack slot, select the Input selector and choose a channel from the Inserts sub-menus.

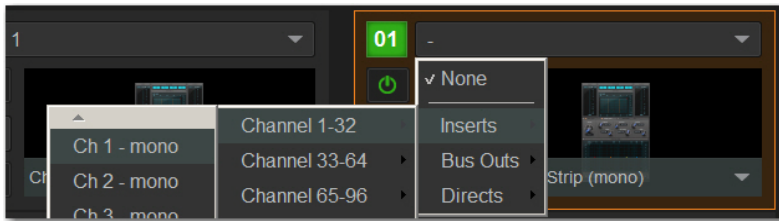

Inserts sub-menus

The rack slot automatically identifies and connects to the first available insert slot on the selected channel. The Channel Insert selector shows the current insert position. In the figure below, I-1 indicates the plug-in is in the first insert Inserts slot of channel 1.

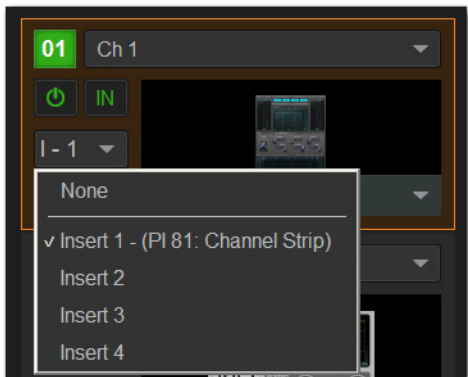

Channel Insert menu

If no insert slots are available on the channel, the selector displays a question mark.

Routing Plug-Ins as Bus Processors (Effect Send/Return)

Plug-Ins can be used on buses for send-and-return processing with effects such as reverb and delay. A plug-in is configured for bus processing by assigning an Aux, Group, Matrix, Main, Monitor output, or a Direct Out as the plug-in input source, then assigning the output of the plug-in to an input channel, or to a hardware output, as follows:

- Return bus-fed plug-ins to an input channel to establish an effects send-and-return path.
- Route bus-fed plug-ins to a hardware output for specialized processing needs (such as feeding an external crossover).

You assign plug-ins for bus processing from the Plug-Ins screen.

To use a plug-in as a bus processor:

- 1 Go to the Plug-Ins page.
- 2 Make sure the plug-in is installed and assigned to a rack slot.
- 3 Select the Input selector at the top of the corresponding rack slot, choose **Bus Outs**, then choose the desired output bus from the sub-menus.

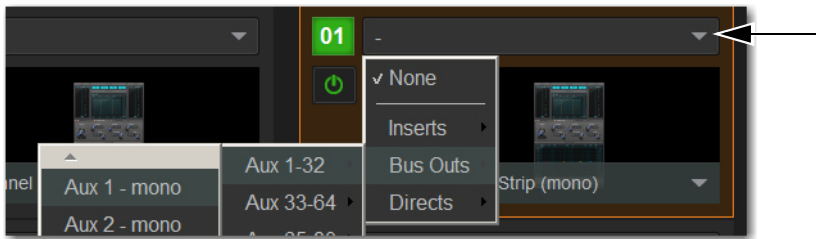

Input selector and sub-menus

- 4 Select the Plug-In Output selector and choose an input channel or a hardware output. Depending on the plug-in's output format (mono/stereo), available channels are lit (available for assignment) or unlit (unavailable for assignment) depending on their format.

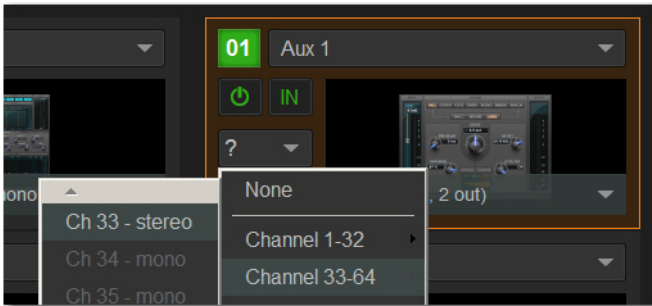

Assigning plug-in output to an input channel



When routing a plug-in with a stereo output to an input channel, make sure the input channel is a stereo channel. See [Make Selected Mono Strips Stereo/Make Selected Stereo Strip Mono](#).

When a bus-fed plug-in has both its input source and output assigned, it appears similar to the following in the rack:



An assigned bus-fed plug-in shown in the rack

Routing Channel Direct Outs to Plug-Ins

You can route the Direct Outs to plug-ins. This lets you directly feed plug-ins from individual channels to preserve Aux buses for other uses, with control over send level using the channel Direct Out level control.

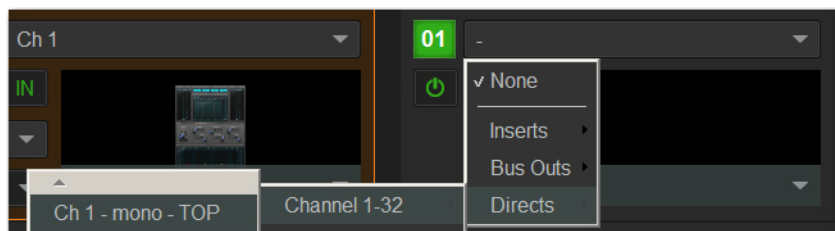

Assigning a channel Direct Out as a plug-in input source in the Plug-Ins page

When a channel Direct Out is routed to a plug-in, it follows the pickoff setting for that specific Direct Out (as set in the Patchbay), and is applied in addition to any other assignment made for that Direct Out. This makes it possible to use a channel's Direct Out to route that channel to both a Pro Tools recording option and to a plug-in.

⚠ *If you do use a Direct Out to feed both a hardware output such as a Pro Tools recording option as well as a plug-in, be aware that any adjustments to that Direct Out affect both the output signal and the signal fed to the plug-in.*

Sidechain Routing

S6L supports sidechain (key) processing for plug-ins that support sidechain triggering. The Sidechain selectors appear across the top of the Plug-Ins page in Zoom view for the targeted plug-in.

To assign side-chain routing to a plug-in:

- 1 Target a plug-in that supports sidechain processing in Zoom view of the plug-in.
- 2 Choose the side-chain source signal from the Key Source pop-up menu.
- 3 Choose the pickoff point (tap) for the side-chain signal from the Source Pickoff pop-up menu.

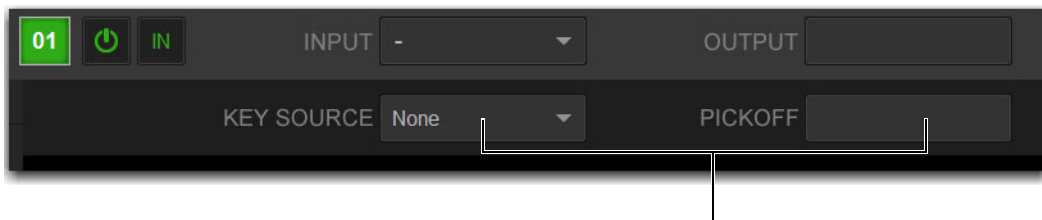

Sidechain controls

⚠ *Side-chain routing is not stored in snapshots.*

Adjusting Plug-Ins on the External Screen

You can adjust plug-ins on the Plug-Ins page.

 You can also adjust plug-ins using the CKMs in Channel Control mode. See [Adjusting Plug-Ins on the Control Surface](#) for more information.

To adjust a plug-in on-screen:

- 1 Attention a channel.
- 2 Go to the Plug-Ins page.
- 3 Double-tap a plug-in icon in any rack view to open that plug-in window in Zoom view.
- 4 Adjust the parameters for the plug-in appearing in the window as desired.

Bypassing Plug-Ins

Plug-Ins can be bypassed on-screen in the Inputs or Outputs page and from the Plug-Ins page.

To toggle a plug-in on/off (in/out of circuit):

- 1 Select the channel on which the plug-in is inserted.
- 2 Go to the Inputs page and select the in/out button next to the desired plug-in to toggle it in/out of circuit. When the button LED lights, it indicates that the plug-in is in-circuit. When unlit, the plug-in is out-of-circuit (bypassed).



An engaged plug-in (top) and a disengaged plug-in (bottom)

Plug-In Presets and Snapshots

You can save and load plug-in Presets files to import, export, and transfer plug-in settings files.

Snapshots can also be used to automate changes to plug-in routing and settings.

 *Presets can be applied to multiple Shows, while snapshots apply only to the Show file in which they are stored.*

Plug-Ins and Presets

Presets are files that you can create to save, load, archive and transfer custom plug-in settings. You can then create your own Preset folders to organize Preset files. Preset folders and files can be transferred using the Filing page.

To create a custom Presets folder:

- 1 Go to the Filing page and select the Transfer tab.
- 2 Select the Preset Folders icon.
- 3 Select the New button at the left of the screen.
- 4 Do one of the following:
 - To leave the folder at its default name, press Enter.
 - or –
 - Type a new name and press Enter.

To save a Preset:

- 1 Adjust the plug-in parameters as desired.
- 2 On the Plug-Ins page, select the Presets icon.

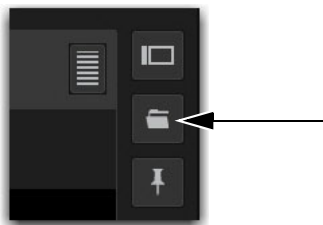

Plug-In Presets icon

- 3 In the Presets window, select **New**.
- 4 Enter a custom name for the Preset.

To load a Preset into a plug-in:

- 1 Make sure the presets are already transferred and available on the current system. (Many plug-ins come with factory presets that will be installed along with the plug-in.)
- 2 Select the channel containing the plug-in, and target the desired plug-in.
- 3 Select the Presets icon in the Plug-Ins screen.
- 4 Select a preset name in the Presets list to preview it. With the Presets list displayed, do any of the following:
 - To scroll through the list, press Up or Down arrow keys on your computer keyboard.
 - To load a preset and close the Presets list, double-tap a name in the Presets list.
 - Select **Cancel** to close the Presets list without changing settings.

Plug-Ins in Snapshots

Snapshots can automate plug-in settings, including routing, and in/out state. (Side-chain routing is not supported in Snapshots.) Snapshots can also store and recall Tempo.

 *Snapshots do not store or recall Presets. Snapshots store plug-in settings as they were when the Snapshot was created or saved.*

Each rack slot on the Plug-Ins page provides a Snapshot menu, with shortcuts for common snapshot-related tasks:

- Create a new snapshot
- Add one or more plug-ins to the MIDI/Plug-Ins list, and automatically re-scope the snapshot to include plug-ins.
- Remove plug-ins from one or more snapshots

Snapshots Containing this Plug-In Lists all currently loaded snapshots referencing the plug-in, in sequential order. Choose a snapshot to load it. (This menu option is useful for targeting snapshots while editing plug-in racks.)

Create New Snapshot Containing this Plug-In Adds a new snapshot to the snapshot list in which only plug-ins are scoped. This snapshot is inserted immediately after the currently targeted snapshot, which may not necessarily be the last snapshot. The snapshot is named to reflect the plug-in rack position, for example: “PI 1-1: Reverb One” is a Reverb One plug-in assigned to rack 1, slot 1.

Add (or Update) this Plug-In to Snapshot Adds a plug-in reference, with current settings, if the currently targeted snapshot does not already reference this plug-in. If the currently targeted snapshot already references this plug-in, the choice is Update (see next). If multiple snapshots are selected, this command changes to “Add Plug-In to Selected Snapshots” for batch-assignment.

Update this Plug-In in Snapshots Updates snapshots with current settings, if the currently targeted snapshot (or currently selected snapshots) already references this plug-in.

Remove this Plug-In in Snapshot Removes reference to this plug-in from the currently targeted snapshot, or from all currently selected snapshots.

 See [Adding Plug-In Data to Snapshots](#).

Tempo Settings in Snapshots

Each snapshot can store a custom tempo value. You can use the Tempo Enable icon to enable or disable tempo recall when the associated snapshot is recalled, letting you automate delay times in plug-ins that support Tempo Sync. See [Adding Tempo Data to Snapshots](#).

Plug-In DSP Usage

Plug-Ins utilize DSP resources when they are assigned to a rack slot, and that rack slot is powered on. Each HDX DSP card installed in an E6L engine provides 18 DSPs for plug-in processing.

Plug-In availability is limited to available DSP resources. Certain plug-ins use more DSP resources than others. You may not be able to instantiate a plug-in if there are not enough DSP resources available. You can turn off unused plug-ins to reclaim their DSP by making them inactive, or by removing them from the system.

You can view plug-in DSP usage on the Options > Devices page.

To view plug-in DSP usage:

- 1 On the external screen, go to Options > Devices.
- 2 In the HDX DSP section, select a tab 1–4 to view currently active plug-ins and the DSPs they are allocated to on the corresponding HDX TDM Mix Engine card.

Plug-In Levels

Meter levels on the S6L system are displayed in dBVU, with 0 dBVU = +4dBu analog out = -20dBFS.

Internally, the S6L system provides up to 32-bit processing for built-in EQ, dynamics, and plug-ins, with level matching circuitry and logic ensuring maximum fidelity and sonic performance throughout the entire signal path. Due to variances in how plug-in metering is implemented by different manufacturers, performance may vary with regard to plug-in gain reduction meters and their relative levels.

When using side-chain routing, be aware of potential level differences between input channel pickoff points. For more information, see [Sidechain](#).

Plug-In Latency and Processing Delay

Plug-In latency includes processing delay of the plug-in itself plus routing delay, as follows:

- Instance delay: 2 samples per plug-in
- DSP routing delay: 3 samples

Viewing Plug-In Latency

Cumulative channel processing delay can be viewed by touching-and-holding (right-clicking) the Inserts area of the selected channel. The cumulative delay includes latency reported by all inserted plug-ins, signal routing and the known hardware insert delay, if applicable.

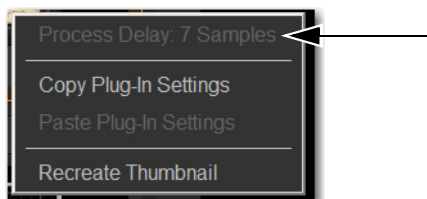

Cumulative process delay

Individual plug-In processing delay can be seen by touching-and-holding (right-clicking) the plug-in icon in the rack. Use the number reported when calculating latency for manual delay compensation.

Examples

If there is only one plug-in on a channel, the total delay will be the amount of plug-in latency + 2 + 3. (2 samples for the one plug-in instance, plus 3 samples for the DSP routing to the racks and back.)

If you have two plug-ins on a channel or bus, the delay will be plug-in #1 latency + 2 + plug-in #2 latency + 2 + 3. If plug-in #1 has 12 samples of latency, and plug-in #2 has 15, total latency will be 34 samples (12 + 2 + 15 + 2 + 3).

Initializing the Plug-In Racks

The racks are initialized (or re-initialized) whenever the system is first powered on, whenever the system is restarted, after installing a plug-in, and after disabling or re-enabling a plug-in.

While the racks are initializing, they are offline and do not process audio. Avoid performing any Filing or Transfer functions until the racks are finished initializing. Rack status is displayed on-screen in the banner display.

Tap Tempo for Plug-ins

Tap Tempo lets you quickly establish a system tempo to use as a beat clock for delay and echo plug-ins that support Tempo Sync.

The system tempo defaults to 120 BPM (beats per minute). You can set a custom tempo in a number of ways including by tapping a Function switch, Footswitch or other control as explained below. The system tempo is stored as a console setting within the Show file. Snapshots can also store and recall tempo.

Using Tap Tempo

To use Tap Tempo, first enable the system tempo, create a Tap Tempo event, then enable tempo sync on the delay or echo plug-in.

Enable the System Tempo

To enable the System Tempo:

- 1 Go to Options > Misc and locate the Tap Tempo section.
- 2 Turn on global tempo sync for the system by selecting the On switch directly below the Tempo encoder so that it lights (on).

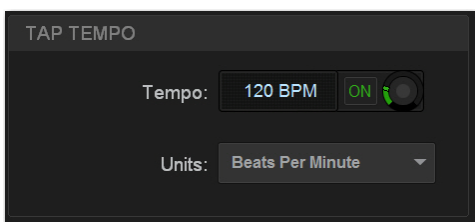

Tap Tempo options

- 3 If desired, select the Units selector to choose Beats Per Minute (BPM) or Milliseconds as the units for displayed values.

Enable Plug-in Tempo Sync and Start Tapping

To enable tempo sync on the plug-in:

- 1 Navigate to a delay plug-in and enable its tempo sync button. Repeat for other delay plug-ins you want to sync.



Tempo Sync button in Mod Delay III



How the tempo sync button is labeled differs depending on the plug-in. See the documentation for the plug-in to locate the tempo sync button.

- 2 Tap the assigned Tap Tempo trigger (Function switch or Footswitch) in time with the music. At least two taps are needed to set the tempo; additional taps can result in a more accurate tempo setting.

The delay time of all Tempo Sync-enabled plug-ins change to match the system tempo. While tapping, the calculated tempo is also shown in the Status area of the screen.

Tips for Using Tap Tempo

The plug-in Tempo Sync switch enables/disables that individual plug-in's delay value from following the system tempo. Use the individual plug-in Tempo Sync switches to sync one, some or all delay plug-ins.

Tempos can range from 20 BPM (3,000 ms) to 300 BPM (200 ms). Some delay plug-ins offer different time divisions (such as 1/8th, 16th, or dotted) that you can select for variations based on the system tempo. Check your delay plug-ins to see if they support Tempo Sync and subdivision settings (most, but not all, do).

Snapshots and Tempo Sync

If you need a specific delay time every time a certain snapshot is recalled, store Tempo with snapshots. For details, see [Adding Tempo Data to Snapshots](#).

WSG-HD Waves SoundGrid Option Card and Waves Plug-Ins

The WSG-HD Waves SoundGrid Option Card from Avid lets you integrate Waves SoundGrid processing directly into your VENUE | S6L mixes.

Once the WSG-HD Card is installed in your E6L engine, plug-ins hosted on the Waves SoundGrid server appear on the VENUE Plug-Ins screen inside of the Waves SoundGrid Rack plug-in (up to 8 plug-ins per instance of SoundGrid Rack). Up to two compatible Waves SoundGrid servers can be connected simultaneously for redundancy with automatic fail-over.

Setup and Configuration

Installing and configuring Waves software and your WSG-HD card requires the following steps:

- [Preparing and Connecting the VENUE System for Waves Installation](#)
- [Downloading and Preparing the Waves Installer](#)
- [Transferring Licenses](#)
- [Installing on S6L System](#)
- [Completing the Installation](#)

Preparing and Connecting the VENUE System for Waves Installation

To prepare your S6L system and connect it to the internet:

- 1 Make sure you have performed a System Restore to install VENUE software version 5.7 or higher on your VENUE system (see the *VENUE S6L Installation Guide.pdf* for instructions).
- 2 Make sure you have installed the WSG-HD Card in your E6L Engine (see the *WSG-HD Card Installation* guide, included with the card and available for download from your Avid account).
- 3 Make sure you have connected the WSG-HD card to your SoundGrid server(s).
- 4 Make sure you have a USB flash drive (formatted to FAT32) and a Windows computer connected to the internet (to unzip Waves software and create USB installers).

 *At the time of this writing a Windows computer is required to unzip and create installers. Macs with VMWare Fusion, Parallels and similar are also supported. You can download the installer from a Mac but you must extract it from a Windows computer or from a Mac running Windows on VMWare Fusion, Parallels, or similar.*

- 5 (Optional) If you plan to transfer licenses directly to your S6L control surface, make sure to connect the control surface to the internet via the **ECx** port.

Downloading and Preparing the Waves Installer

Important! Installation may vary with different versions of Waves software. Always refer to the latest installation instructions from Waves.com.

To create your installer:

1 Navigate to the download page on waves.com and select SoundGrid Rack for VENUE Installer to download the .zip.

⚠ *At the time of this writing a Windows computer is required to unzip and create installers. Macs with VMWare Fusion, Parallels and similar are also supported. You can download the installer from a Mac but you must extract it from a Windows computer or from a Mac running Windows on VMWare Fusion, Parallels, or similar.*

2 Insert your FAT32-formatted USB drive into an available USB port on your Windows computer.

3 Extract the download and place the resulting Waves folder on the root level of your USB drive.

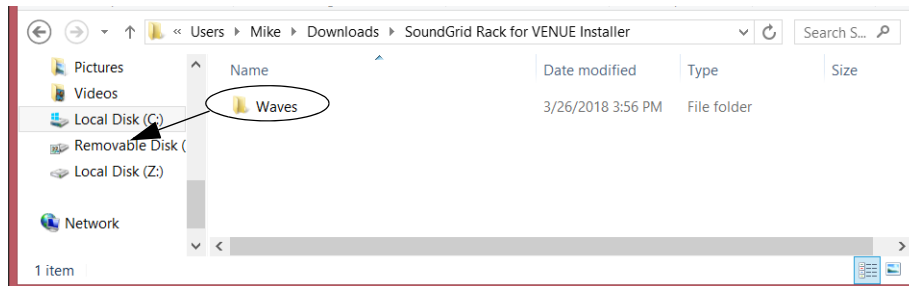

Placing the folder "Waves" at the root level of a USB drive

Transferring Licenses

Licenses can be transferred to and stored on either a USB drive, the console, or distributed across both. At minimum, the SoundGrid Rack for VENUE license must be present on your system to run Waves. In addition:

- Transfer licenses to your USB drive if you want your licenses, including SoundGrid Rack for VENUE, to remain mobile. Storing licenses on a USB drive also means they will not need to be re-installed onto the S6L system after performing a VENUE System Restore.
- If your system is going to be used in a festival or similar multi-operator setting, transfer the SoundGrid Rack for VENUE license to the console to ensure it is available for all operators. Each operator can then bring their own USB drive containing only the plug-in installers and plug-in licenses needed for their performance.

To transfer the required licenses:

1 Make sure you have registered/activated your Waves plug-in purchases.

2 Do the following:

- To transfer license to your USB drive: On your computer, open Waves Central and log into your account.
- To transfer licenses to S6L: On VENUE, go to Options > Devices, select the WSG-HD card in the Expansion Cards list, click to display the Settings tab in the Information section and then click Launch Waves Central. (Make sure your S6L is connected to the internet as instructed earlier, and that you have installed Waves Central as instructed later in this guide.)

3 Select Licenses/Manage: Licenses.

4 Select Source: My License Cloud.

5 Select Products: SoundGrid Rack for VENUE as well as any plug-in licenses that you want to transfer.

6 Select Destination: your USB drive, or Console.

7 Click Send Licenses.

Installing on S6L System

To install components onto your S6L system:

- 1 Make sure you have installed VENUE software version 5.7 or higher, and that your system is powered on.
- 2 Install Waves Central by doing the following:
 - Connect the USB drive on which you built your Waves installer to an available USB port on the S6L control surface.
 - Enable Config mode, navigate to **Options > System**, then select **Update**. When prompted to confirm that you want to install Waves Central, click **INSTALL**.
 - Follow the on-screen instructions to install Waves Central.
 - Click **Finish**.
 - When prompted to restart, click **OK**.
- 3 Install Waves plug-ins by doing the following:
 - After the system restarts, enable Config mode.
 - Go to **Options > Devices**, select the **WSG-HD** card in the **Expansion Cards** list, click to display the **Settings** tab in the **Information** section and then click **Launch Waves Central**.

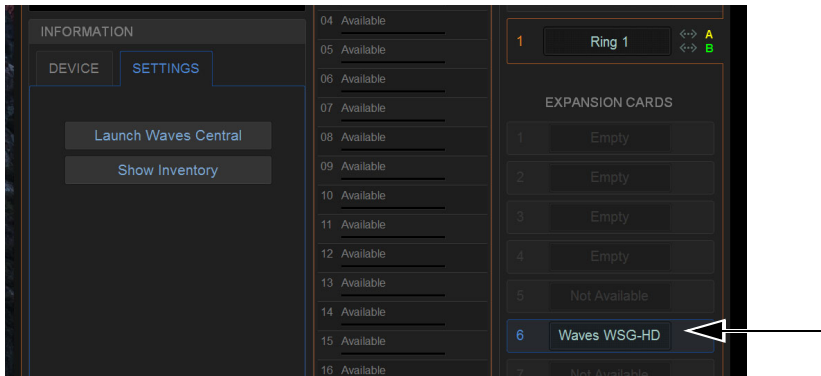

Options > Devices showing Settings for a WAVES-SG card selected in Expansion Card slot 6

- Select **Install**.
 - **Install From:** your USB key.
 - **Choose Products to Install:** **SoundGrid Rack for VENUE**, as well as any plug-ins you want to install.
 - Click **Install**. Wait while the installation completes (it takes several minutes).
 - When the message **Products from Package were Successfully Installed** appears, click **OK**.
 - Close **Waves Central**.
 - Enable **Config mode**.
 - Go to **Options > Plug-Ins**, select **WaveShell1SoundGridRack-AAX** and click **Install**.
 - When installation is finished, restart your S6L system.
- 4 Set up **Inventory** by doing the following:
 - Enable **Config mode**.
 - Go to **Options > Devices**, select the **WSG-HD** card in the **Expansion Cards** list, click to display the **Settings** tab in the **Information** section and then click **Show Inventory**.
 - 5 Set the **Network Port** to the Intel port number ending in “LM” (such as **Intel(R)82579LM Gigabit Network Connection**).

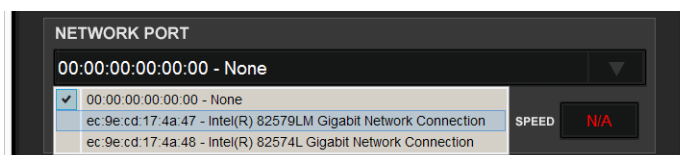

Selecting a network port

6 Select the Avid WSG-HD card as IO device.

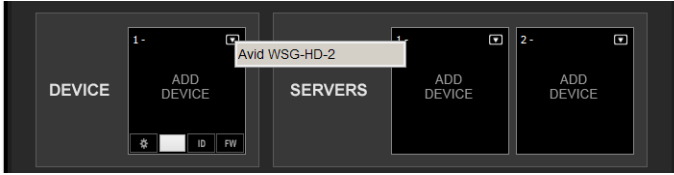

Selecting Avid WSG-HD as an IO Device

7 Select your Server device.

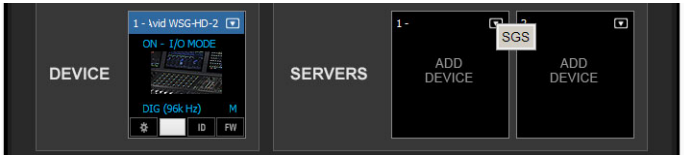

Selecting a SoundGrid server

8 Select Redundant Server if applicable.

9 If necessary, update WSG-HD firmware and Server firmware by clicking the FW icon. The FW icon indicates firmware status as follows:

- Red means firmware is not compatible
- Blue means firmware is compatible but a new version is available.
- Grey/Black means firmware is up to date



*If any errors occur during the firmware update click **RETRY** until it successfully completes.*

10 Click Hide Inventory.

Completing the Installation

Complete the installation by doing the following:

- 1 Power cycle all SoundGrid servers.
- 2 Power cycle your S6L system by doing the following:
 - Go to Options > System, and choose Shutdown.
 - Power down the S6L control surface, E6L engine and all attached Stage I/O units. Wait for them to power down completely.
- 3 Power the S6L system back on.

Using SoundGrid Plug-Ins

After making connections and configuring SoundGrid with S6L, you can start integrating SoundGrid plug-ins into your Show files. Similarly, if you have older VENUE Show files that incorporated Waves plug-ins you should be able to load those Shows and have your previous Waves plug-in configurations transfer automatically (as long as all the required plug-ins are available on the current system).

To use SoundGrid plug-ins:

- 1 In VENUE, go to the Plug-Ins page.
- 2 Select SoundGridRack from the Effect sub-menu of the Plug-In selector for an available rack slot.

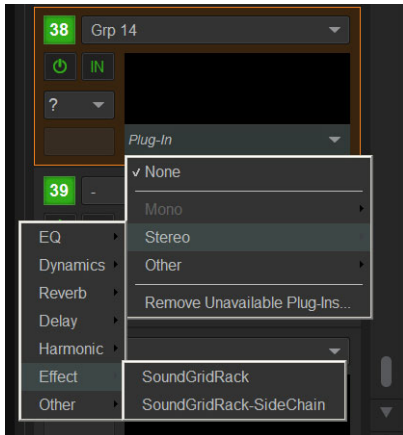

Assigning SoundGridRack to a VENUE plug-in rack slot

SoundGrid Rack appears in the Plug-in window, showing 8 available SoundGrid Rack slots.

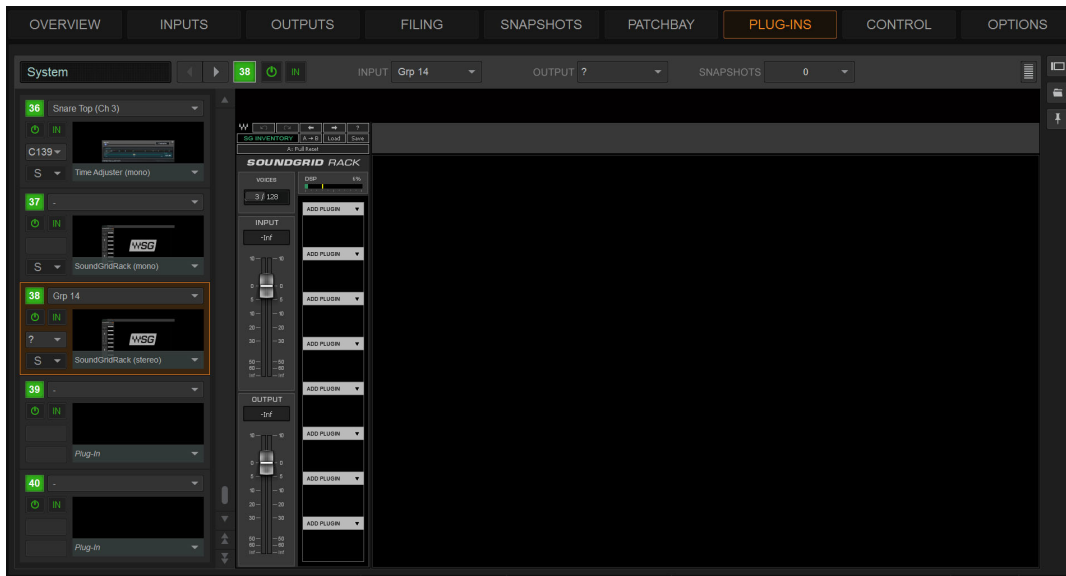

A SoundGrid Rack (empty)

- 3 Within SoundGrid Rack, insert up to 8 plug-ins.

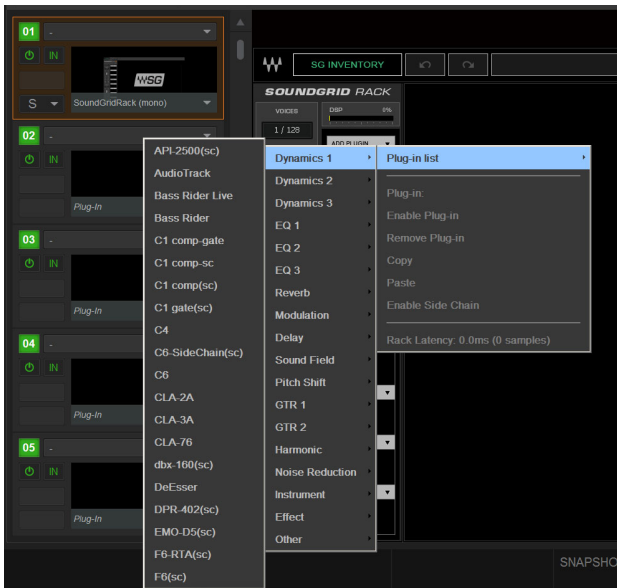

Inserting a Waves SoundGrid plug-in to a slot within an instance of SoundGrid Rack

The selected plug-in is assigned to that slot.



SoundGrid Rack showing plug-ins in slots 1 and 2

- 4 In the VENUE rack slot for the SoundGrid Rack, configure plug-in routing as desired for use as a channel insert or bus processor.

Opening Show Files with Legacy TDM Waves Plug-Ins

When opening older Show files, any legacy TDM instances of Waves plug-ins are automatically converted to SoundGrid Rack plug-ins. In the VENUE Plug-In rack these converted instances will appear as “SoundGrid Rack” (check the zoomed view to see which specific plug-ins are inside that rack).

Snapshots and SoundGrid Plug-Ins

Technically each instance of SoundGrid Rack is a single plug-in. Saving plug-ins in a VENUE snapshot stores all plug-ins within a SoundGrid Rack instance. You cannot use Snapshots to re-assign Waves plugs within SoundGrid Racks while in Show mode, you must be in Config mode (since this could potentially require a DSP reshuffle). You can, however, use Snapshots to change plug-in settings while in Show mode.

Note that the following actions are not allowed via snapshots (“child plug-ins” refers to plug-ins within an instance of SoundGrid Rack):

- Moving Waves child plug-in order
- Removing Waves child plug-ins
- Adding Waves child plug-ins

Configuring Redundant SoundGrid Servers

By connecting a compatible SoundGrid server to each of the network ports on the WSG-HD card you can run the SoundGrid servers in a redundant configuration. To minimize fail-over time during a rehearsal or performance it is recommended to pre-load the second, redundant SoundGrid server as described below. This procedure only takes a short amount of time and helps ensure the fastest switching possible.

To minimize fail-over time, do the following:

- 1** Load a Show file and/or configure the Plug-in Racks with instances of SoundGrid Rack and Waves plug-ins on the active (primary) SoundGrid server.
- 2** After confirming the racks are configured with all the Waves plug-ins you want, disconnect the network cable from the WSG-HD card that is connected to the active (primary) SoundGrid server.

The second, redundant SoundGrid server begins loading the current configuration. This might take a minute or two depending on the number of SoundGrid Racks and plug-ins in use.

After the redundant SoundGrid server has loaded the configuration, reconnect the first, primary server.

Events

An *event* consists of one or more *triggers*, which are configured to cause one or more *actions* to occur.

Events can be very simple, such as the press of a Function switch enabling a Mute Group, or the press of a connected footswitch triggering a Recall Next Snapshot. These are examples of a single specific *trigger* (a press of a specific Function switch or the press of a footswitch) causing a single *action* (enabling a Mute Group or Recall Next Snapshot).

Events can also be quite complex and involve multiple triggers and actions. For example, a single event can be defined so that moving a specific fader above and/or below a certain level sends a General Purpose output, *and* recalls a specific snapshot *and* mutes one or more channels. Multiple triggers can be considered conditionally using the available logic operators AND, OR, and XOR.

Events can be defined to operate on specific channels, or to operate globally using the “Any...” Triggers and “Triggered....” Actions.

Any...Triggers Many sub-menus in the Triggers menu include choices for Any Aux, Any Group, Any Matrix, Any Mains, and Any VCA (when relevant). Any Strip refers to any input, output, or bus. Any Channel refers to Input Channels only. These let you define triggers that fire whenever the defined criteria is met on *any* strip, channel type, or channel.

Triggered Strip Actions Similarly, many sub-menus in the Actions menu provide the choice for Triggered Strip. Choosing Triggered Strip creates an action that is applied to the input, output, or bus on whichever strip triggered the Event.

Each event can have between 0 and 8 triggers, and each event can have between 0 and 8 actions. Up to 999 events can be created.

The Event list is easy to configure, and pre-configured events are provided to change View Mode on the external screen.



For more information on the default events and other examples, see [Default Settings, Templates and Examples](#).

Terminology

Event A user-defined combination of one or more triggers and one or more actions. Each event serves as a type of software “macro” in which you establish a cause-and-effect relationship between one or more triggers and their results (actions).

Trigger A conditional check used to fire an event, such as the press of a Function switch. Other available Triggers include fader above/below, meter values, time of day, and MIDI.

Action A command, mode or other response resulting from an event being triggered.

Control (Continuous) A variable control such as a fader or knob.

Control (Switch) A two-state control such as most switches on the control surface.

System Values Variables such as Fader Above or Below, and system response values such as channel meters and dynamics gain reduction meters.

GPI General Purpose Interface, also known as a logic interface. The S6L control surface provides 2 GPI inputs and 2 GPI outputs.

Open GPI input or GPI output is floating, or at its reference voltage. Or, a Gate is open.

Closed GPI input or GPI output is closed. Or, a Gate is closed.

Footswitch Footswitch ports are functionally identical to GPI inputs and share all of the same properties and behaviors.

Properties The criteria that define triggers and actions. Properties can be edited for many, but not all types of triggers and actions.

Important Information about Snapshots and Events

Because events can trigger snapshot recalls, and because snapshot recalls can trigger other events, it is possible to create logic “feedback loops.” For more information, see [Avoid Feedback Loops](#).

The Events Tab

The Events tab of the Control page is the working area of the Event list system. Events are defined and managed using the Event list, along with the Triggers and Actions lists. The lists and commands available in these sections create a powerful, user-programmable environment. Footswitch and GPI status display are also shown on the Events tab. You can create and load Events Presets, and import events into the current Show file.

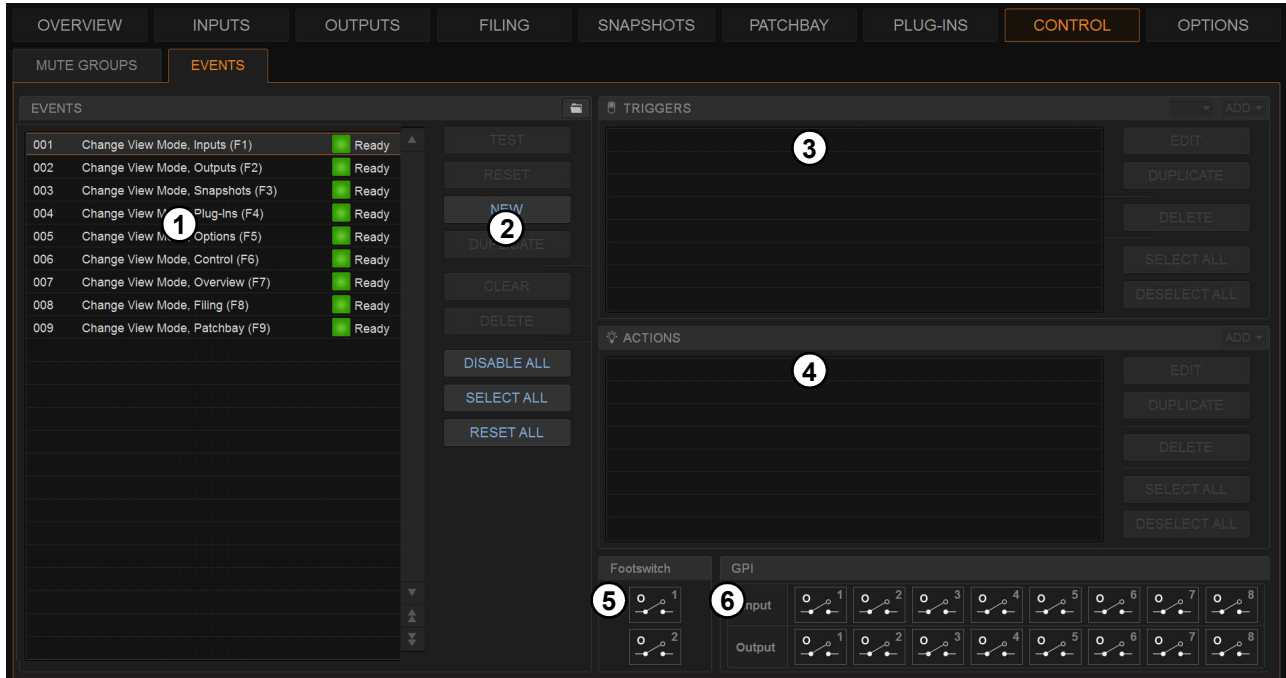
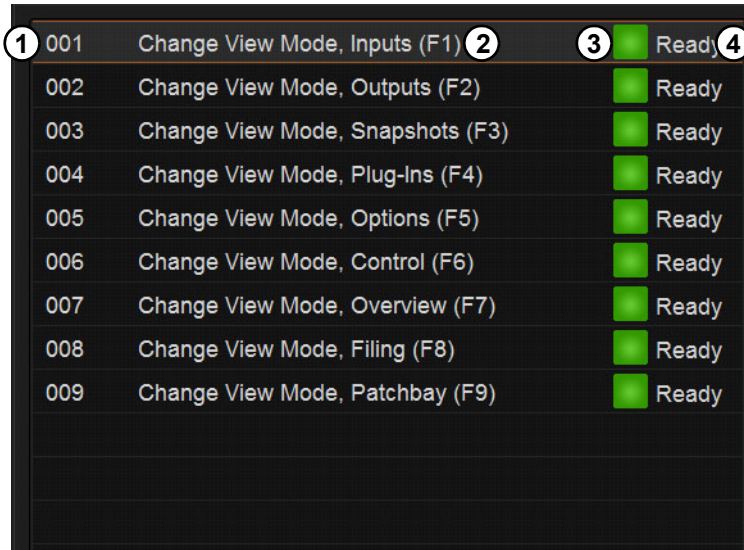

Figure 3. Events window (Control > Events)

- 1 – Event List
- 2 – Event List Commands
- 3 – Triggers
- 4 – Actions
- 5 – Footswitch Status Display
- 6 – GPI I/O Status Display

Event List

Each event is shown in its own row within the Event list. The list can be scrolled vertically when necessary.



1	001	Change View Mode, Inputs (F1)	2	3	Ready	4
	002	Change View Mode, Outputs (F2)			Ready	
	003	Change View Mode, Snapshots (F3)			Ready	
	004	Change View Mode, Plug-Ins (F4)			Ready	
	005	Change View Mode, Options (F5)			Ready	
	006	Change View Mode, Control (F6)			Ready	
	007	Change View Mode, Overview (F7)			Ready	
	008	Change View Mode, Filing (F8)			Ready	
	009	Change View Mode, Patchbay (F9)			Ready	

Event list items, commands and displays

The Event list contains the following elements:

1 – Event Number

Each event has an associated three digit sequence number, 001 through 999. Events are automatically re-numbered if items are moved, added or removed.

2 – Event Name

Events can be given custom names, up to a maximum length of 31 characters.



Although more than 31 characters can be entered, limit your Event names to 31 characters or less.

3 – Event Enable Icon

Events can be enabled or disabled individually by selecting the green Enable indicator to toggle its status. All events can be disabled (suspended) and enabled using the global **Disable All** button.

4 – Event Status

The Event Status column shows Active (currently in effect), Ready, Disabled (indicated by a dash) or Test state. For more information on the Status column, see [Resetting Events](#).

Event List Commands

You can test, reset, create, duplicate, clear or delete events in the list. These commands apply to any selected (highlighted) events in the list, and can be performed using the buttons or by touching-and-holding (right-clicking) list items. Multiple events can be selected to test, reset, duplicate, clear or delete them, but only one new event can be created at one time.

You can also utilize Events Presets.

Triggers

The Triggers list shows the name and properties of each trigger defined for the currently selected event, as well as commands to create and manage triggers.



Triggers list

1 – Triggers List

Each event can have up to eight triggers in the list. Triggers are shown in rows in the Triggers list. Touch-and-hold (right-click) commands to select, edit, duplicate and delete triggers.

2 – Type and Properties

Each row in the Triggers list shows the selected trigger type. Some types of triggers have editable properties such as a dB level on a specific channel, or open/closed state of a footswitch or GPI input. Choices vary depending on the trigger type, and not all triggers have editable properties.

 *Triggers assigned to Function switches become available in the VENUE Function Pad app. Each Show file can store up to 128 Function switch assignments.*

3 – Add

The Add pop-up menu lets you create new triggers. Triggers are organized in the menu according to the type of input signal that initiates (or triggers) the event. Types of triggers include channel functions, system values, footswitch/GPI inputs, snapshot recall, and other functions such as talkback.

4 – Logical Operators

Multiple triggers can be considered conditionally by applying a logical operator (AND, OR, XOR) to their properties.

 *Triggers and actions which are unavailable due to hardware configuration or other factors are shown as italicized in the Trigger (and Action) Add menus.*

5 – Triggers List Command Buttons

You can edit, reset, duplicate, delete, and select/deselect all triggers in the list. These commands can be performed using the on-screen buttons or by touching-and-holding (right-clicking) list items. Multiple triggers can be selected for editing, but only one new trigger can be created at one time.

Actions

The Actions list shows the actions defined in the currently selected event, as well as commands to create and manage actions.

1 – Actions List

Each event can have up to eight actions in the Actions list. All actions occur when the event is fired. Touch-and-hold (right-click) commands let you select, edit, duplicate and delete actions.

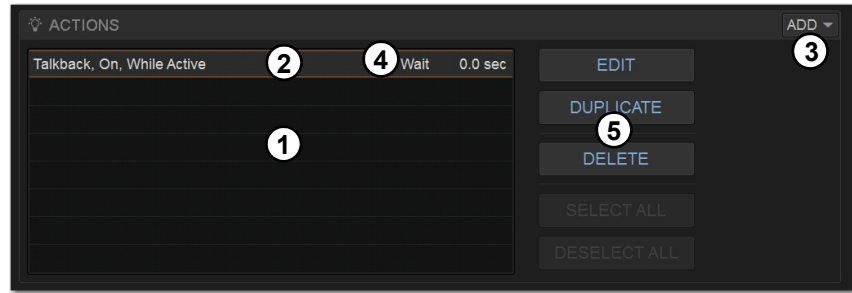

2 – Type and Properties

Each row in the Actions list shows the selected action type. Some actions have editable state and behavior settings. Some actions have editable properties such as on/off or toggle state for Control (Switch) actions or open/closed state of a GPI output. Some continuous control actions have editable values (Relative or Absolute) with cross-fade options. Choices vary depending on the action type, and not all actions have editable properties.

3 – Add

The Add pop-up menu lets you create new actions. Actions are organized in the menu according to the type of function they affect, such as channel functions, snapshots, GPI Output and Tap Tempo.

4 – Wait

All actions have a Wait (delay) setting that can be applied to the action.

5 – Triggers List Command Buttons

You can edit, reset, duplicate, delete, and select/deselect all actions in the list. These commands can be performed using the on-screen buttons or by touching-and-holding (right-clicking) list items. Multiple actions can be selected for editing, but only one new action can be created at one time.

Footswitch Status Display

The Footswitch status display shows the current open or closed status of Footswitches connected to the Footswitch connectors on the S6L control surface. Default state for both Footswitches is closed. A Footswitch can be added as a trigger for an action in an event. Example uses of a Footswitch trigger includes Tap Tempo and snapshot recall. The Footswitch can be named.

GPI I/O Status Display

The GPI port on the back of the S6L control surface can be used to trigger events in VENUE from outboard equipment (GPI input), or can be used to send messages to trigger outboard equipment to perform one or more actions (GPI output).

The GPI status display shows the current open or closed status of the two GPI inputs and two GPI outputs. Each input and output can be named.

GPI Inputs GPI inputs can be added as a trigger for an action in an event. Example uses of GPI inputs include remote snapshot recall and remote channel muting from an external control system or custom control panel.

GPI Outputs GPI outputs can be added as an action triggered by a selected trigger. Example uses of GPI output include the following:

- Sending a pulse to trigger samplers and playback devices
- Indicating when a microphone or channel is live by lighting an On Air or “tally” light
- Flashing or turning on a light when the system is in a particular mode (such as Solo In Place)
- Integrating with power sequencing devices for automated system turn-on

 For GPI port wiring specifications, see [GPI Port Reference](#).

Creating Events

The basic steps to create an event include the following:

- Add a new event in the Event list (see [Adding an Event](#)).
- Add and configure triggers for the event (see [Adding Triggers to an Event](#)).
- Add and configure actions for the event (see [Adding Actions to an Event](#)).

 Several pre-defined (default) events are available immediately; others **Default Events** are available among the Demo Shows installed with the system software. You can load these defaults using Events Preset, and import individual events into the current Show file.

Adding an Event

To add a new event to the Event list:

- 1 Go to the Control page and select the Events tab.
- 2 Do any of the following:
 - To create an empty, untitled new event, select the **New Event Command** button.
 - or –
 - To create a copy of a pre-existing event, select one or more events in the Event list and select the **Duplicate** button.
- 3 Double-tap the event name in the list, and enter a name for the event.

Selecting Events

Event list items can be selected, renamed, duplicated, deleted, cleared, enabled or disabled, tested and reset. Selected events are highlighted in the Event list.

To select one or more events, do any of the following:

- To select a single event, select its row in the Event list.
- To select all events, select the **Select All** button in the Event Commands section.
- To select multiple consecutive events, select the first desired event and then Shift-touch the last desired event. All events in between are selected.
- To select multiple non-consecutive events, or to de-select an individual event, Ctrl-touch its row in the Event list.

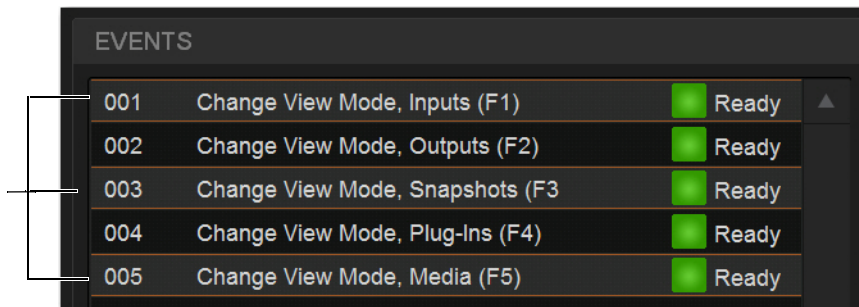

Multiple events selected in the Event list

To deselect or ore more events:

- Touch-and-hold (right-click) anywhere in the Event list and choose **Deselect All**.

Moving Events

Selected events can be dragged and dropped to new locations in the list. You can also manually edit the event number to re-sequence items.

To move one or more events:

- 1 Select one or more events in the Event list.
- 2 Touch any selected event and drag them to a new location in the list. As you move events, a white line appears indicating the destination.
- 3 Release your finger to drop the events at the desired location in the Event list. When moving multiple events, moved events will be adjacent regardless of their original locations relative to each other (whether adjacent or non-adjacent). events will be renumbered as necessary according to the new sequence of events.

To manually edit an event number:

- Double-tap the Event Number and enter a new three digit number to resequence the list accordingly.

Managing Events in the Event List

Once created, events in the list can be managed using on-screen buttons and touch-and-hold (right-click) commands to rename, duplicate, delete, clear, enable or disable them.



You can also use the Test and Reset commands to manually audition events for development and diagnostics. For more information, see [Testing Events](#)

Renaming an Event

To rename an event:

- 1 Double-tap the event name in the list.
– or –
- 2 Touch-and-hold the event name, the select **Rename** from the menu.
- 3 Enter a new name.
- 4 Press **Enter** to confirm the new name.

Event Name and Function Keys Function keys are automatically named with the Event name when defined as a Trigger for one or more Events. The Event / Function key name is displayed in the right bank of Soft Keys on the MTM when Function keys are shown. When a Function key is assigned to multiple Events, the Function key name displayed on-screen is the name of the Event with the lowest number in the Events List.

Duplicating an Event

Duplicating an event can simplify Event list configuration when multiple, similar events need to be created, each with slightly different properties.

To duplicate an event:

- 1 Select one or more events in the Event list.
- 2 Select the **Duplicate Event Command** button on-screen. Or, tap-and-hold (right-click) a selected event and choose **Duplicate**.

Deleting and Clearing an Event

Deleting an event removes it permanently from the Event list. *Clearing* an event leaves the named event in the Event list but clears all associated triggers and actions.

To delete an event:

- 1 Select one or more events in the Event list.
- 2 Select the Delete Event Command button on-screen. Or, touch-and-hold (right-click) a selected event and choose Duplicate.
- 3 Select Delete in the Confirm Event Operation dialog to delete the event. Or select Cancel to cancel the operation.

To clear an event:

- 1 Select one or more events in the Event list.
- 2 Select the Clear Event Command button on-screen. Or, touch-and-hold (right-click) a selected event and choose Clear.
- 3 Select Clear in the Confirm Event Operation dialog to clear the event. Or select Cancel to cancel the operation.

Enabling and Disabling Events

Events can be disabled to suspend their operation. An event can be selected and edited while it is disabled. You can toggle the enabled state of one or more events in the list by selecting the on-screen Enable icons in the Event list, or you can disable the Event list globally by selecting the master event Disable All button.

Disabling an event stops all timers (X-Fade and Wait/delay properties) associated with that event, preventing any pending (delayed) actions configured for While Active behavior from occurring. Disabling an active event does not automatically de-activate any associated actions configured for While Active behavior. Use the Reset command instead (see [Resetting Events](#)).

 *Disabling an event can be a useful troubleshooting tool, such as when an event has caused an action/trigger feedback loop and must be edited before being re-enabled.*

To toggle the enable/disable status of an event in the list:

- 1 Select one or more events in the Event list.
- 2 Select the Event Enable icon for the selected event to toggle its state. Or, touch-and-hold (right-click) an item and choose Enable or Disable as appropriate. When the Enable icon lights (green) and “Ready” is shown in the Event Status column, the event is enabled. When the icon is unlit and a dash is shown the event is disabled.

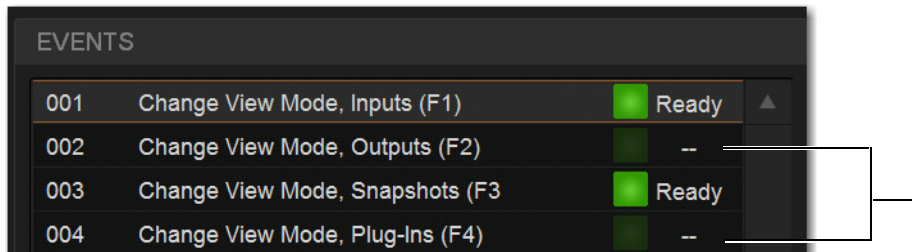

Disabled events

To disable all events:

- 1 Select the Disable All Events Command button. The Disable All button lights, and all items in the Event list show a dash in the Status column.
- 2 To re-enable all events select the Disable All button again.

All events are prevented from firing when the global Disable function is in effect. However, active events are not de-activated. Use Reset or Reset All for this (see [Resetting Events](#)). Individual event enable/disable status is preserved (events retain the current state of their Enable icons) and can be modified when globally disabling and enabling events using the master Disable button.

Events Presets

You can save and load Events Presets files to import, export, and transfer Events. You can also create your own Events Preset folders to organize Events Preset files. Preset folders and files can be transferred using the Filing page. A Factory Preset file is installed automatically, letting you restore Events definitions created at the factory.

 *The factory (Default) Events Presets contain definitions for **F** (Function) keys 1-9 to jump to different pages on the external screen.*

To create a custom Presets folder:

- 1 Go to the Filing page and select the Transfer tab.
- 2 Select the Preset Folders icon.
- 3 Select the **New** button at the left of the screen.
- 4 Do one of the following:
 - To leave the folder at its default name, press Enter.
 - Type a new name and press Enter.

To save a Preset:

- 1 Go to **Control > Events**, and configure the Events list as desired.
- 2 On the Events tab, select the Presets icon.

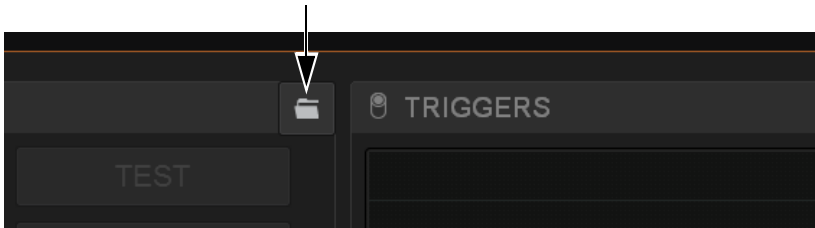

Events Presets icon (Control > Events)

- 3 In the Presets window, select **New**.
- 4 Enter a custom name for the Preset.

To load a saved Events Presets file:

- 1 Make sure the presets are already transferred and available on the current system.

 *Selecting Events Presets replaces all events currently in the list. To selectively add events to the list, see [Import Snapshots and Events](#).*

- 2 Go to **Control > Events**.
- 3 Select the Presets icon.
- 4 Select a preset name in the Presets list to preview it. With the Presets list displayed, do any of the following:
 - To scroll through the list, press Up or Down arrow keys on your computer keyboard.
 - To load a preset and close the Presets list, double-tap a name in the Presets list.
 - Select **Cancel** to close the Presets list without changing settings.

To rename, duplicate, delete, or overwrite a Presets file:

- 1 Go to **Control > Events**.
- 2 Select the Presets icon.
- 3 Right-click on the item and choose **Rename**, **Duplicate**, **Delete**, or **Overwrite**.

To transfer Events Presets:

- 1 Go to the Filing page and select the Transfer tab.
- 2 Connect a USB flash drive to the S6L control surface. The device appears above the right column.
- 3 Select the Events block.

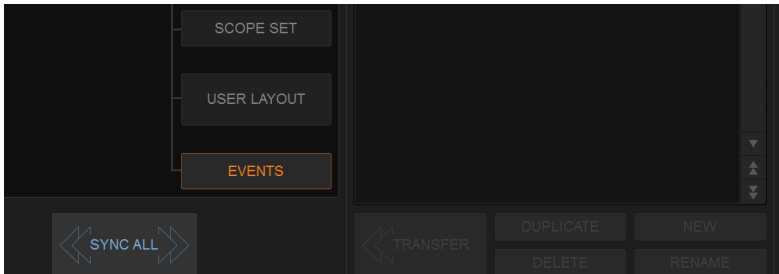

Events selected in Filing > Transfer

- 4 Do one of the following to select the items to transfer:
 - In the left column, select the items you want to transfer to the portable storage device.
 - or –
 - In the right column, select the items you want to transfer from the portable storage device to your system.Be sure to select the desired folder for the destination/source device. For more information on creating Presets folders and navigating the Filing page, see the *VENUE S6L System Guide.pdf*.
- 5 Select the Transfer button.

Creating Triggers

Each Event can have up to eight triggers. You create new triggers by selecting them from the Add pop-up menu.

Once added, you can edit triggers and their properties to customize them.

Adding Triggers to an Event

To add a trigger:

- 1 Select an Event in the Event list, or create a new one. (For details, see [Selecting Events](#), and [Creating Events](#).)
- 2 Select the ADD button in the Triggers list, and then choose the trigger type from the pop-up menu or any of its sub-menus.

The chosen trigger type is added to the Trigger list for the currently selected Event, with its default properties. The figure below shows an example trigger based on Function Switch 1.

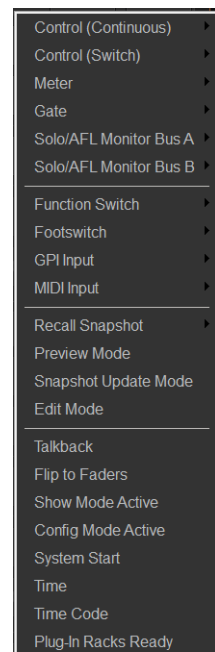

Triggers menu

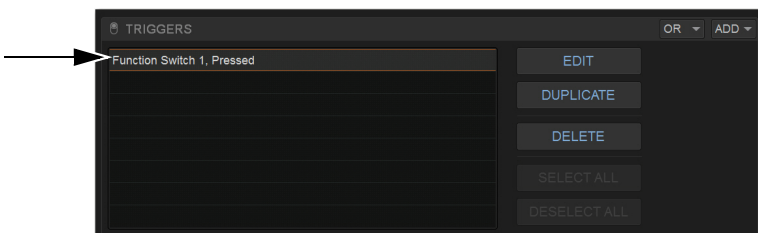

Trigger added to Triggers list

 For a list of available trigger types, see [Trigger Types](#). For examples of different trigger types in use, see [Examples](#).

Editing Trigger Type and Properties

To edit the trigger and its properties:

- 1 Double-tap the trigger row in the list. Or touch-and-hold (right-click) the action item and choose Edit.
- 2 Choose a new Trigger Type, or edit any of the available properties in the row for that trigger. Properties vary depending on the type of trigger selected (not all trigger types have editable properties).
- 3 Touch anywhere else to exit.

Logical Operators for Triggers

An individual trigger is considered to be “true” when the function described by its type and properties takes place, such as while a footswitch is actually pressed, or a fader is raised above its trigger threshold.

A trigger is considered to be “false” (or, not occurring) whenever its function and properties are not met, such as when a footswitch is not being pressed, or while a fader remains below its assigned trigger threshold.

When an Event includes multiple triggers, a logical operator (OR, AND, XOR) must be chosen from the Operators pop-up menu. (The default Operator is OR.)

The logical operator has no effect when the Triggers list includes only one item.

To choose a logical operator for the current Event:

- 1 Select the desired Event to display its assigned triggers.
- 2 Select the Operators pop-up menu (by default, this pop-up menu displays “OR”) and choose AND, OR, or XOR.

Only one logical operator is permitted per event, and this operator applies to all triggers within the event. It is not possible to use a mix of logical operators within an event. For examples of logical operator behaviors, see [Examples of Logical Operators](#).

Managing Triggers in the Triggers List

Triggers in the list can be selected, edited, duplicated and deleted.

Selecting Triggers

Triggers can be selected using the same methods as used when selecting items in the Event list. For more information, see [Selecting Events](#).

Editing Triggers

To edit a trigger:

- 1 Select the item in the Triggers list so it is highlighted, then select the Edit button.
 - or –
- Touch-and-hold the desired trigger, then select Edit from the menu.

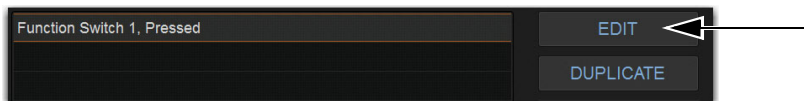

The Trigger List Edit button

When the chosen item is a switch or other two-state control, selectors for Type (**1** in the figure below) and State (**2** in the figure below) are displayed in the trigger row.



Properties for a switch trigger

When the chosen item is a continuous control or value, selectors for Type (**1** in the figure below), Control (**2**), Above/Below (**3**, for Fader, Meter, and certain other Types), and editable field for Value (**4** in the figure below) are displayed.

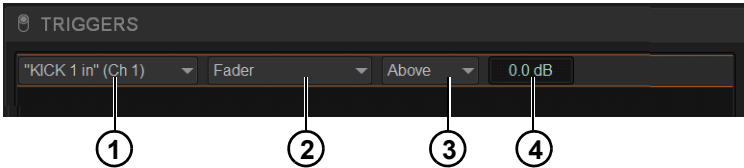

Properties for a continuous control trigger

2 Do any of the following:

- To change the trigger type (such as choosing a completely different control, choosing a different channel, or changing a trigger to an “Any...” type), select the Type pop-up menu and make a new selection from the Type menu.
- For switches, buttons and other two-state functions, select the State pop-up menu and make a selection. Choices for State vary as appropriate for the trigger type, and will include Closed or Open, On or Off, and Pressed or Released.
- For continuous controls, use the Above/Below pop-up menu (as available) to define the trigger. To change the specific trigger control or value for the current type (such as to change Fader to Aux level for the current channel), select the Control pop-up menu and make a new selection.
- For Fader Above/Below triggers (such as for faders), select the currently displayed dB value to highlight it, then type in a new value.
- For System Values (such as Meter Above/Below), set a dB value, Hold time and Release time.

3 To confirm your changes, press Enter or select anywhere else in the Events window.

Duplicating Triggers

To duplicate a trigger:

- 1 Select the item in the Triggers list so it is highlighted, then select the Duplicate button.
– or –
- Touch-and-hold the desired trigger, then select Duplicate from the menu.

Deleting Triggers

To delete a trigger:

- 1 Select one or more items in the Triggers list so it is highlighted, then select the Duplicate button.
– or –
- 2 Touch-and-hold the desired trigger, then select Duplicate from the menu.

Channel X / Y Function Switches

In their default configuration, the **X** and **Y** switches in each channel strip toggle the corresponding Expander/Gate and Compressor/Limiter on/off, respectively. You can reconfigure these switches to instead become available Triggers and Actions.

To enable channel X and Y switches for use as Triggers:

- In the Fader Configuration section of the Options > Interaction tab, enable the Use X/Y as Event Triggers/Actions option.

When enabled for use as Triggers and Actions:

- **X** and **Y** switches become available in the Switch (Type) list in the Trigger properties, in the Control Surface sub-menu.

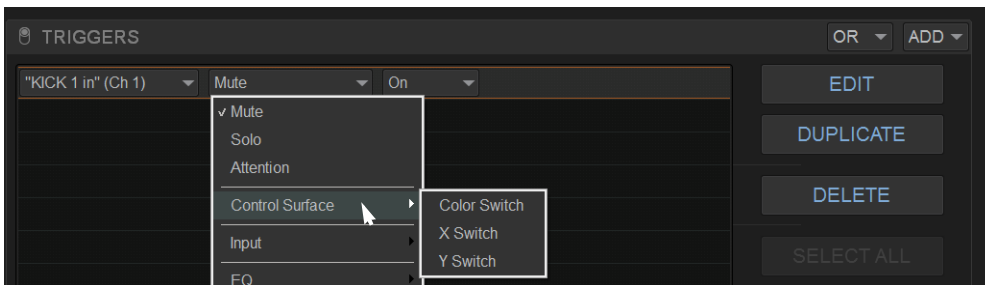

X and Y in the Switch sub-menu (requires the Use X/Y as Event Triggers/Actions setting is enabled in Options > Interaction)

- **X** and **Y** switch LED state (Light and Flash) become available in the Switch (Type) list in the Action properties, in the Control Surface sub-menu.
- **X** and **Y** switches no longer toggle their corresponding dynamics processor on/off, even if they are not yet included in the definition of any specific Event.

System Values as Triggers

Events can be triggered by meter above/below values, and by Gate open/closed state.

Editable properties for System Value Triggers include the following:

Hold How long the threshold must be met or exceeded before the Trigger becomes active.

Release The length of time the Trigger stays active once the value has crossed the threshold again.

Creating Actions

Each event can have up to eight actions. You create new actions by selecting them from the Add pop-up menu.

Once added, you can customize actions by editing their properties, as available.

Adding Actions to an Event

To add an action:

- 1 Select an event, or create a new one.
- 2 Select the ADD button in the Action list, and then choose an action type from the pop-up menu (shown at right).

The chosen action type, with its default settings, is added to the action list area. The figure below shows an example action has been added to control Talkback.

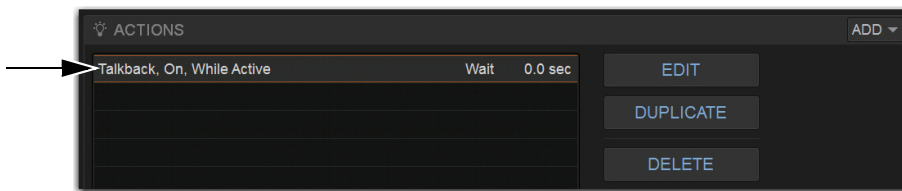

Action added to Action list



For a list of available actions, see [Action Types](#). For examples of different types of actions in use, see [Examples](#).

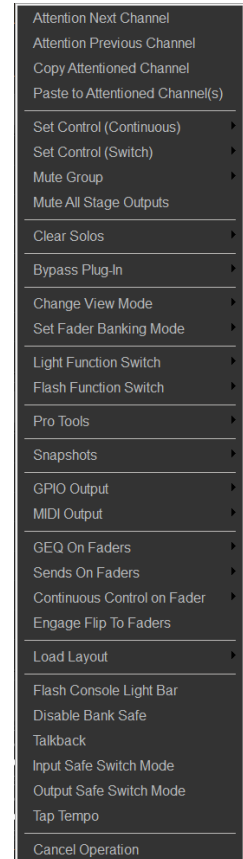

Actions menu

Editing an Action Type and Properties

To edit an action:

- 1 Select an item in the Actions list so it is highlighted, then select the Edit button.
– or –
- 1 Touch-and-hold the desired trigger, then select Edit from the menu.
- 2 Select the displayed action Type and make a new selection.

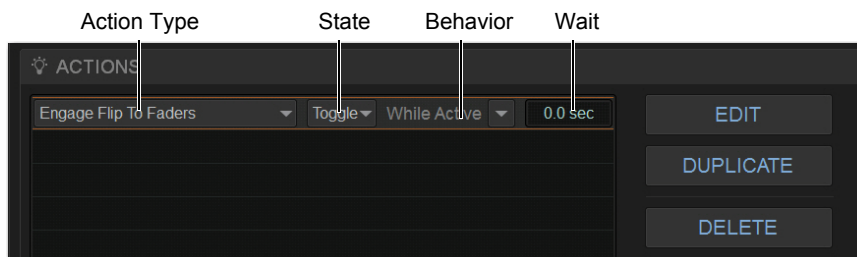

Action properties for a switch (two-state) control

Action State

To edit an action State for switches, buttons and other two-state functions:

- Select the State pop-up menu and make a selection. Choices for State vary as appropriate for the trigger type, and will include Closed or Open, On or Off, and Toggle.

Action Behavior

To edit action behavior for switches, buttons, and other two-state functions:

- Select the Behavior pop-up menu and choose Latch or While Active, as appropriate:

Latch Fixes the behavior in its defined state (such as open or closed) until unlatched by another event or operation.

While Active Latches the behavior in its defined state as long the associated trigger is in effect (active, or “true”), such as unmuting a channel only while a footswitch is pressed and held.

Pulse and Duration (GPI Output only) Produces a single-shot pulse output. Duration range is 0.1 second (100 ms) to 1.0 second, in 0.1 second increments. The default duration is 0.3 seconds (300 ms).

To configure GPI output pulse and duration for an action:

- 1 Double-tap the action to edit it.
- 2 Select the Behavior pop-up and choose Pulse.
- 3 Enter a value for Pulse Duration.
- 4 To confirm you changes, press Enter or select anywhere else in the Events window.

Action Wait

All actions let you specify a Wait time of up to 100 seconds for the action to wait before firing. This can be useful for synchronizing the timing of multiple external devices, or to build timed sequences of actions.

To configure action Wait (Delay):

- 1 Double-tap the action to edit it.
- 2 Select the Wait value box to highlight it and enter the desired time.

Absolute and Relative Continuous Control Actions

When defining an Action to raise or lower a continuous control (such as channel volume or Aux Send level) you can choose to apply an Absolute or Relative change, with or without a cross-fade.

Absolute Sets the parameter to an explicit value, such as setting a fader to exactly +3 dB.

Relative Adjusts the parameter by a defined value relative to its current position. For example, lowering a fader by - 2 dB.

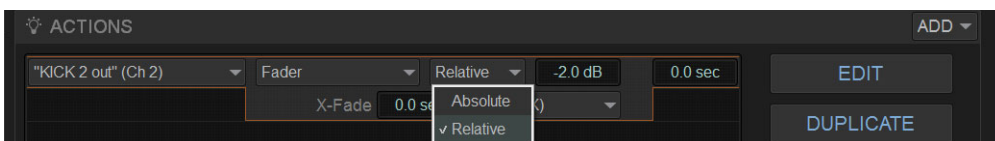

Defining a Relative action

X-Fade Continuous Controls

Control (Continuous) Actions can have a cross-fade included in their definition, with variable shape.

To include a cross-fade in an Action:

- 1 In the Actions list, select the specific Action and click Edit (or double-click the Action).
- 2 Enter a value for X-Fade, and if desired choose an available shape for the cross-fade (such as Linear, Sine, X²).

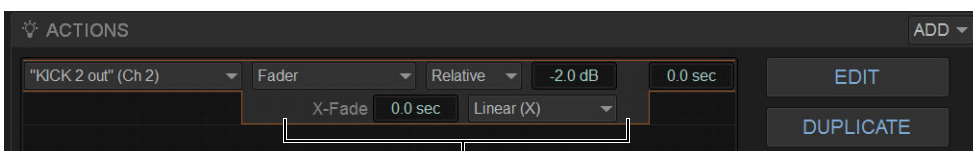

Cross-fade (X-Fade) and Shape

Selecting Actions

Actions can be selected using the same methods as used when selecting items in the Event list. For more information, see [Selecting Events](#).

Managing Actions in the Actions List

Actions can be moved, renamed, duplicated, and deleted, just as you can with triggers. For instructions on managing items in the Actions list, follow the instructions for triggers in [Managing Triggers in the Triggers List](#).

Testing Events

An event can be manually triggered to test it, regardless of its current status or enabled/disabled state. Use this feature to verify action properties and confirm proper operation of devices connected to GPI output ports. When an event is in Test mode, it is effectively considered true until the event is manually reset. An event in test can be re-tested at any time by again pressing the Test button. You do not have to reset in-test events to re-test them. Incoming triggers are ignored when events are in Test mode. For example, if a footswitch event is being tested and you accidentally hit the footswitch at some point during the test, the event does not revert to Active the moment Test is canceled. Events always return to their ready state following a Reset. Events won't re-fire until the trigger logic re-asserts itself as true.

To test events:

- 1 Select one or more events in the Event list, then select the Test button.
- 2 When you're satisfied the event is behaving correctly, select the Reset button.

Resetting Events

You can use the Reset command to quickly reset Active or in-Test events to "ready." You can also use the Reset All command to immediately reset all events in the list. The current status of each event is shown in the Status column in the Event list:

Status	Description
Active	Event is currently true (triggered)
Ready	Event is currently false (not triggered)
Disabled	Event is disabled and can not be triggered
Test	Event has been manually triggered

To reset an event:

- Select one or more events in the Event list (see [Selecting Events](#)), then select the Reset Event Command button.

To reset all events:

- Select the Reset All button.

When events are reset, the following rules are applied:

- ◆ Latching or pulsed actions which have already occurred are unaffected. For example, reset does not unlatch a previously latched function.
- ◆ All action delay timers (Wait) are immediately canceled.
- ◆ Actions configured for While Active behavior are immediately canceled.
- ◆ Events will not occur until the trigger logic again evaluates as true.

For example, let's say you have an event configured to close a GPI Output whenever Channel 3 is muted (its behavior property is While Active). Resetting the event opens the GPI Output, even though Channel 3 might still be muted. The event will re-trigger the next time the channel goes from an unmuted state to a muted state.

Snapshots and Events

Events can include snapshot functions among their triggers and actions.

Snapshots as Triggers

Events can be triggered by the following snapshot functions:

- Recall of specific snapshots
- Enabling of Snapshot modes (Preview, Update and Edit)

Snapshots as Actions

Event actions can include the following snapshot functions:

- Recall of a specific snapshot
- Recall the previous, next or selected snapshot.
- Initiate Store to Selected Snapshot commands (overwriting and updating snapshots)
- Enable different Snapshot modes (Preview, Update and Edit)

Snapshot Modes and Event Status

While in Update or Edit modes, events-driven snapshot recall is suspended.

While in Preview mode, triggers that occur in the online state of the system are executed, including MTC-driven recall of snapshots. Triggers caused by changes to the offline (Preview) controls are ignored and do not cause events to occur.

Avoid Feedback Loops

Because events can both affect and be affected by snapshots, it is possible for events to cause “feedback loops.”

Be especially careful when Recall Previous or Next snapshot triggers and actions are combined with events that recall a specific snapshot, as shown in the following diagram.

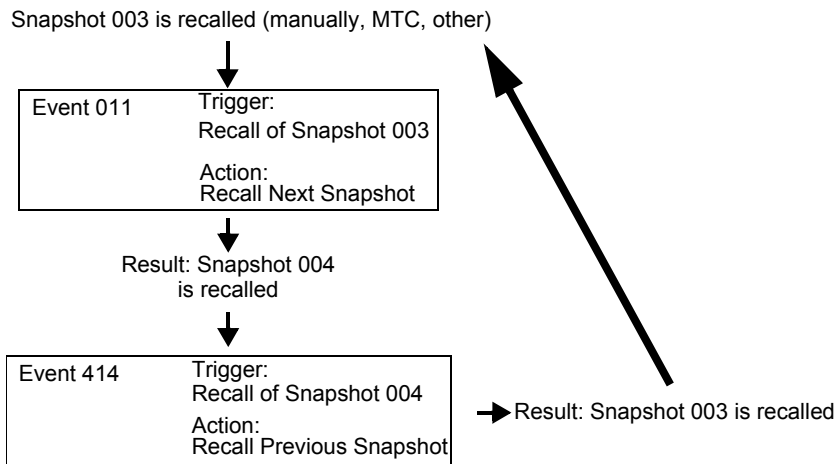

Diagram illustrating potential logic feedback loop between events and snapshots



The global event *Disable All* and *Reset All* buttons can serve as “panic” buttons to temporarily suspend and/or reset all events, giving you a chance to diagnose the source of any problems. For more information, see [Resetting Events](#).

Default Settings, Templates and Examples

Default Events

Each Demo Show file contains a set of default events that can be used as a starting point to build your own events. Some examples of the types of default events for S6L include the following:

Examples of default events

Default Event Type and Name	Triggers	Actions
Inputs (F1)	Function Switch 1, Pressed	Light Function Switch 1, On, While Active, Wait 0.0 sec. Change View Mode - Inputs Page, Wait 0.0 sec.
Outputs (F2)	Function Switch 2, Pressed	Light Function Switch 2, On, While Active, Wait 0.0 sec. Change View Mode - Outputs Page, Wait 0.0 sec.
Snapshots (F3)	Function Switch 3, Pressed	Light Function Switch 3, On, While Active, Wait 0.0 sec. Change View Mode - Snapshots Page, Wait 0.0 sec.
Plug-Ins (F4)	Function Switch 4, Pressed	Light Function Switch 4, On, While Active, Wait 0.0 sec. Change View Mode - Plug-Ins Page, Wait 0.0 sec.
Options(F5)	Function Switch 5, Pressed	Light Function Switch 5, On, While Active, Wait 0.0 sec. Change View Mode - Options Page, Wait 0.0 sec.
Control (F6)	Function Switch 6, Pressed	Light Function Switch 6, On, While Active, Wait 0.0 sec. Change View Mode - Control Page, Wait 0.0 sec.
Overview (F7)	Function Switch 7, Pressed	Light Function Switch 7, On, While Active, Wait 0.0 sec. Change View Mode - Overview Page, Wait 0.0 sec.
Filing (F8)	Function Switch 8, Pressed	Light Function Switch 8, On, While Active, Wait 0.0 sec. Change View Mode - Filing Page, Wait 0.0 sec.
Patchbay (F9)	Function Switch 9, Pressed	Light Function Switch 9, On, While Active, Wait 0.0 sec. Change View Mode - Patchbay Page, Wait 0.0 sec.



To see the default (factory) Function key assignments, use the **Clear Console** command.

Examples

The following table provides a listing of example event definitions. Use the techniques explained throughout this chapter to add one or more of the following events to establish your own set of events, triggers and actions.

Example Application of Event Elements, Triggers, and Actions

Example Application	Elements		
	Type	Menus	Definition/Properties
If any input fader goes below -60, mute that channel	Trigger	Control (Continuous) > Any Channel	Any Channel, Fader, Below -60 dB
	Action	Set Control (Switch) > Triggered Strip	Triggered Strip, Mute
If any Input Channel meter stays above +3 dB for 2 seconds, engage Gain Guess on that channel	Trigger	Meter > Any Channel	Any Channel Meter, Above, +3 dB, 2 sec.
	Action	Set Control (Switch) > Triggered Channel	Triggered Strip, Input > Gain Guess, On
If any Input Channel meter stays above +3 dB for more than 3 seconds, lower the input level on that channel by -3 dB	Trigger	Meter > Any Channel	Any Channel Meter, Above, +3 dB, 3 sec.
	Action	Set Control (Continuous) > Triggered Strip	Triggered Strip, Fader, Relative, -3 dB
Pressing a Channel Color switch puts that channel's Direct Out level on its fader	Trigger	Control (Switch) > Any Strip	Any Strip, Color Switch, Pressed
	Action	Continuous Control on Fader > Triggered Strip	Triggered Strip, Direct Out, Toggle

Example Application of Event Elements, Triggers, and Actions

Example Application	Elements		
	Type	Menus	Definition/Properties
If the spare vocal input Gate closes, mute that input	Trigger	Gate > Channel <channel number/name>	Closed
	Action	Set Control (Switch) > Channel <channel number/name>	<channel number/name>, Mute, On
Link a custom Layout to Sends on Faders so that when you flip that Aux to faders it spills in that custom layout (* Note: Requires that the "Sends on Faders Follow AFL" option is enabled for Mon bus A or B, in Options > Buses)	Trigger	Control (Switch) > Aux <desired Aux>	Aux <desired Aux>, Solo, On *
	Action	Load Layout > Load Layout <Layout name>	Load Layout <Layout name>

Templates

The following table provides additional suggested event definitions. Use the techniques explained throughout this chapter to add one or more of the following events to establish your own set of events, triggers and actions.

Suggested event definitions for common functions

Event Name	Trigger Type	Trigger Properties		Action Type	Action Properties		Behavior
Talkback (Toggle)	Footswitch		Closed	Talkback		Toggle	Latch
Talkback (Momentary)	Footswitch		Closed	Talkback		On	While Active
Fader Start	Fader Above	Ch 1	-60 dB	GPI Output 1		Closed	Pulse (0.3 s)
Fader Stop	Fader Below	Ch 1	-inf dB	GPI Output 1		Closed	Pulse (0.3 s)
Fader Start/Stop	Fader Above	Ch 1	-60 dB	GPI Output 1		Closed	While Active
Mute Channel (Toggle)	Footswitch	1	Closed	Mute	Ch 1	Toggle	
Mute Group 1 (Toggle)	Function Switch	9	Pressed	Mute Group	1	Toggle	Latch
Toggle Input Safe Switch mode	Function Switch/		Pressed	Input Safe Switch Mode			
Tap Tempo	Function Switch		Pressed	Tap Tempo			
Pro Tools Start Record	Function Switch		Pressed	Pro Tools > Record			

Using the Templates

To add any of the events listed in the table, do the following (using the first template, Talkback (Toggle) as an example):

To use the templates:

- 1 Create a new event.
- 2 Edit the event name (for example, "Talkback (Toggle)" as shown in the table). For renaming instructions, see [Renaming an Event](#).
- 3 Select the (Trigger) Add pop-up menu and choose Footswitch > Switch 1 (Footswitch 1). The Switch 1 trigger type is added, with a default State setting of Closed.
- 4 Select the (Action) Add pop-up menu and choose Talkback. The Talkback action is added. By default, the action State is Toggle, and the behavior is Latched. There is no Wait (delay before firing) needed for this action.

Switch 1 (Footswitch 1) is now configured to toggle Talkback On or Off each time the footswitch is pressed.

If you prefer momentary talkback, edit the event by doing the following.

- 1 Double-tap the Talkback action in the Actions list to access its editable properties.
- 2 Select the action State pop-up menu (it displays Toggle by default, or the current State setting) and select On.
- 3 Select the action Behavior pop-up menu and choose While Active. Together with the State setting (On), While Active establishes momentary control of the action; in this example, Footswitch 1 is now assigned to provide momentary Talkback control.

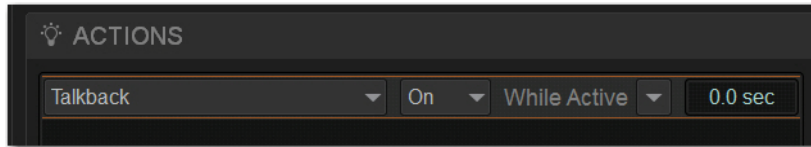

Talkback State and Behavior after editing

- 4 To quickly test the switch trigger, select the Test button, or press the Footswitch. Adjust the trigger State for your footswitch, as necessary, for its open/closed orientation. (For instructions, see [Editing Trigger Type and Properties.](#))
- 5 After testing the trigger, select Reset to return the event to its Ready state.

Trigger Types

The following table lists the available trigger types and properties, along with a description of each.

Trigger Menus

Menu	Property 1	Property 2	Property 3	Description
Control (Continuous) >	Any Strip Any Channel Channel 1-n > Any Aux Aux 1-n > Any Group Group > Any Matrix Matrix > Any Mains Mains > Any VCA VCA 1-n >	Fader (default)	Fader level, Above / Below, -inf to +12 dB (Default: -60 dB)	Continuous control moved below or above threshold
		Input >	Pan (position), Width, Delay (ms), Direct Out (level), HPF (freq.), LPF (freq.)	
		EQ >	Gain, Frequency and Q for each of the four bands on Inputs or seven bands on Outputs	
		Dynamics >	Comp/Lim Threshold, Attack, Release, Ratio, Knee, Gain, Key LF and Key HF Exp/Gate Threshold, Attack, Release, Ratio, Hold, Range, Key LF, and Key HF	
		Aux 1 – n >	Aux Send level	
		Inserts >	HW Insert Position	
Control (Switch) >	Any Strip Any Channel Channel 1-n > Any Aux Aux 1-n > Any Group Group > Any Matrix Matrix > Any Mains Mains > Any VCA VCA 1-n >	Mute		Switch Press (down) Switch Release (up)
		Solo		
		Attention		
		Control Surface >	Color Switch X Switch Y Switch (see Channel X / Y Function Switches)	
		Input >	Fader Touch, Gain Guess, Input Direct, Polarity, Delay In, Direct Out In, HPF In, LPF In, Automation Safe, Solo Safe, Mains L/R Assign, Mains C/M Assign	
		EQ >	EQ In, EQ Analog Mode, In (per band), Bell (per applicable band)	
		Dynamics >	Comp/Lim In, SideChain In/HPF In/LPF In/Listen Exp/Gate In, SideChain In/HPF In/LPF In/Listen	
		Aux Send 1 – n >	IN	
		Aux Send Pre/Post 1 – n	Pre/Post	
		Group Send >	IN	
		Inserts >	HW Insert Position	
Meter >	Any Strip Any Channel Channel 1-n > Any Aux Aux 1-n > Any Group Group > Any Matrix Matrix > Any Mains Mains >	Channel 1-n Aux 1-n Group 1-n Matrix Mains	Above / Below, threshold (dB), Hold (ms), Release (ms)	Meter value

Trigger Menus

Menu	Property 1	Property 2	Property 3	Description
Gate >	Any Channel Channel 1-n >	Channel 1-n	Open / Closed	Gate status
Solo/AFL Monitor Bus A >	Any Input Output VCA Solo In Place (Monitor Bus A)		On (default) / Off	Solo/AFL active/inactive
Solo/AFL Monitor Bus A >	Any Input Output VCA Solo In Place (Monitor Bus B)			Solo/AFL active/inactive
Function Switch >	Function Switch 1–128		Pressed (default) Released	Switch Press (down) Switch Release (up)
Footswitch >	Switch 1 (FS 1) Switch 2 (FS 2)		Open Closed (default)	Footswitch input high Footswitch input low
GPI Input >	GPI input 1-8		Open Closed (default)	GPI Input high GPI Input low
MIDI Input >	Note on/off Poly Key Pres. Control Change Program Change Channel Pres. Pitch Bend MMC commands		Channel, Note, Velocity, Value, LBS, MSB Target Device ID (MMC only)	Properties vary with MIDI trigger Type
Recall Snapshot >	Snapshot number and name			Event triggered by snapshot Recall
Preview Mode			On (default) Off	Preview Mode active/inactive
Snapshot Update Mode			On (default) Off	Update Mode active/inactive
Edit Mode			On (default) Off	Edit Mode active/inactive
Talkback			On (default) Off	Talkback active/inactive
Flip to Faders			On (default) Off	Flip to Faders active/inactive
Show Mode Active				Show Mode is active
Config Mode Active				Config Mode is active
System Start				System software initialized
Time			00:00:00	Clock time (24 hour format)
Time Code			00:00:00:00	LTC, MTC
Plug-In Rack Ready				Mirrors plug-ins rack Ready state

Action Types

The following table lists the available Action types and properties, along with a description of each.

Table 6. Action types

Menu	Property 1	Property 2	Property 3	State/Behavior	Description
Attention Next Channel				Wait (0.0 sec. def.)	Selected Channel advances by one
Attention Previous Channel					Selected Channel reverses by one
Copy Attentioned Channel					Channel copy operation
Paste to Attentioned Channel(s)					Channel paste operation
Set Control (Continuous) >	Triggered Strip Channel 1-n > Aux 1-n > Group 1-n > Matrix > Mains > VCA >	Fader (default)	Fader level –inf to +12 dB (Default: –60 dB)	<ul style="list-style-type: none"> Absolute or Relative X-Fade (and variable shapes) Wait (0.0 sec. def.) 	
		Input >	Pan (position), Width, Delay (ms), Direct Out (level), HPF (freq.), LPF (freq.)		
		EQ >	Gain, Frequency and Q for each of the four bands on Inputs or seven bands on Outputs		
		Dynamics >	Comp/Lim Threshold, Attack, Release, Ratio, Knee, Gain, Key LF and Key HF Exp/Gate Threshold, Attack, Release, Ratio, Hold, Range, Key LF, and Key HF		
		Aux 1 – n >	Aux Send level		
		Inserts >	HW Insert Position		

Table 6. Action types

Menu	Property 1	Property 2	Property 3	State/Behavior	Description
Set Control (Switch)	Triggered Strip Channel 1-n > Aux 1-n > Group 1-n > Matrix > Mains > VCA >	Mute		<ul style="list-style-type: none"> • Switch Press (down) / Switch Release (up) • Latch (default) / While Active • Wait (0.0sec default) 	
		Solo			
		Attention			
		Control Surface >	Flash Color Switch Light X Switch Flash X Switch Light Y Switch Flash Y Switch		
		Input >	Gain Guess, Input Direct, Polarity, Delay In, Direct Out In HPF In, LPF In Automation Safe Solo Safe MainsL/R Assign MainsC/M Assign		
		EQ >	EQ In, EQ Ana- log Mode, In (per band), Bell (per applicable band)		
		Dynamics >	Comp/Lim In, SideChain In/HPF In/LPF In/Listen Exp/Gate In, SideChain In/HPF In/LPF In/Listen,		
		Aux Send 1 – n >	IN		
		Aux Send Pre/Post 1 – n	Pre/Post		
	Group Send >	IN			
	Inserts >	HW Insert Posi- tion			
Mute Group >	Mute Group 1–n			<ul style="list-style-type: none"> • On/Off/Toggle (def.) 	Toggle Mute group status
Mute All Stage Outputs				<ul style="list-style-type: none"> • Latch (default) / While Active • Wait (0.0 sec. def.) 	Mutes all outputs of all assigned Stage 64 boxes
Clear Solos >	Monitor Bus A Monitor Bus B Clear All			Wait (0.0 sec. def.)	Mirrors Solo Clear
Bypass Plug-In	Rack names 1-5	Slots 1-25		<ul style="list-style-type: none"> • On/Off/Toggle (def.) • Latch (default) / While Active • Wait (0.0 sec. def.) 	

Table 6. Action types

Menu	Property 1	Property 2	Property 3	State/Behavior	Description
Change View Mode >	Software screen pages			Wait (0.0 sec. def.)	Targets selected pages on-screen
Set Fader Banking Mode >	Split Banking Inputs Outputs VCAs Layouts			<ul style="list-style-type: none"> • On/Off/Toggle (def.) • Latch (default) / While Active • Wait (0.0 sec. def.) 	
Light Function Switch >	Light Function Switch 1–n			<ul style="list-style-type: none"> • On/Off/Toggle (def.) • Latch (default) / While Active • Wait (0.0 sec. def.) 	Lights Function switch
Flash Function Switch >	Flash Function Switch 1–n			<ul style="list-style-type: none"> • On/Off/Toggle (def.) • Latch (default) / While Active • Wait (0.0 sec. def.) 	Flashes Function switch
Pro Tools >	Stop			Wait (0.0 sec. def.)	Transport controls for Pro Tools playback and recording
	Play				
	Record				
	Record Enable All VENUE Tracks				Tracks in Pro Tools with a VENUE I/O path are record armed (enabled).
	Record Disable All VENUE Tracks				Tracks in Pro Tools with a VENUE I/O path are record disarmed.
Snapshots >	Recall Snapshot >	Snapshot number and name		Wait (0.0 sec. def.)	Recall specified snapshot
	Recall Next Snapshot				Mirrors Snapshot Next button
	Recall Previous Snapshot				Mirrors Snapshot Previous button
	Recall Selected Snapshots				Mirrors Snapshot Recall button
	Store to Selected Snapshot				Mirrors Snapshot Store button
	Preview Mode				<ul style="list-style-type: none"> • On/Off/Toggle (def.) • Latch (default) / While Active • Wait (0.0 sec. def.)
	Snapshot Update Mode			Update mode active while trigger is true	
	Absolute Edit Mode			Enters Edit mode when trigger is true; exits via Absolute when trigger goes false	
	Relative Edit Mode			Enters Edit mode when trigger is true; exits via Relative when trigger goes false	
GPI Output >	Output 1–8			<ul style="list-style-type: none"> • Open/Closed (default)/Toggle • Pulse, 0.3s (default) • Latch/While Active 	Pulses or latches selected GPI Output

Table 6. Action types

Menu	Property 1	Property 2	Property 3	State/Behavior	Description
MIDI Output >	Note on/off Poly Key Pres. Control Change Program Change Channel Pres. Pitch Bend MMC commands	Channel, Note, Velocity, Value, LBS, MSB Target Device ID (MMC only)		Wait (0.0 sec. def.)	
GEQ on Faders >	Toggle GEQ on Faders S6L-32D: • GEQ 20–20k Hz S6L-24D and S6L-24: • GEQ 20–630 Hz • GEQ 800–20 kHz			<ul style="list-style-type: none"> • On/Off/Toggle (def.) • Latch (default) / While Active • Wait (0.0 sec. def.) 	Assigns Graphic EQ controls to the faders for the selected channel
Sends on Faders >	Triggered Strip Aux 1-n				Engages Sends on Faders mode
Continuous Control on Fader	Triggered Strip Channel 1-n > Aux 1-n > Group 1-n > Matrix > Mains >	Input EQ Dynamics Auxes Matrix Sends Matrix Pans Inserts	all continuous controls		Flips the Action control to the fader
Engage Flip to Faders					Mirrors the Flip switch
Load Layout	Layout Name			Wait (0.0 sec. def.)	Load specified Layout
Flash Console Light Bar				Wait (0.0 sec. def.)	Flashes console lights
Disable Bank Safe				<ul style="list-style-type: none"> • On/Off/Toggle (def.) • Latch (default) / While Active Wait (0.0 sec. def.) 	Disables any currently Bank Safed channels
Talkback					Toggles the Talkback output on/off
Input Safe Switch Mode					Cycles through Input Safe Switch modes
Output Safe Switch Mode					Cycles through Output Safe Switch modes
Tap Tempo					Sets the system tempo to synchronize delay plug-ins that support Tempo Sync
Cancel Operation				Wait (0.0 sec. def.)	Mirrors Cancel switch (and Esc key on keyboard)

Examples of Logical Operators

Logical operators determine the precise state required in order for an event to occur as shown in the following tables:

OR At least one of the triggers must be true. The following table shows the effect of OR on events with multiple triggers. In the table, 0 indicates a false condition (not occurring) and 1 indicates a true condition (occurring).

When using OR, if one or more (but not all) of the triggers go false, the event logic is only acted on again when all triggers evaluate to false (result = 0).

Trigger A	Operator	Trigger B	Result
0	OR	0	0
0	OR	1	1
1	OR	0	1
1	OR	1	1

AND All triggers must be true. The following table shows the effect of AND on events with multiple triggers. In the table, 0 indicates a false condition (not occurring) and 1 indicates a true condition (occurring).

Trigger A	Operator	Trigger B	Result
0	AND	0	0
0	AND	1	0
1	AND	0	0
1	AND	1	1

XOR

At least one trigger, but not all, must be true. The following table shows the effect of XOR on events with multiple triggers. In the table, 0 indicates a false trigger condition (not occurring) and 1 indicates a true condition (occurring).

Trigger A	Operator	Trigger B	Result
0	XOR	0	0
0	XOR	1	1
1	XOR	0	1
1	XOR	1	0

Options

The Options page provides several tabs. Of these, the System and Devices tabs are where most system configuration settings and options are enabled and customized:

- The System tab provides the primary tools by which you configure mixing, routing, and processing options.
- The Devices tab provides status, diagnostics, and options for hardware components.

This chapter shows you how to manage the most important System and Devices settings, and describes the settings available in other Options screens.

Overview of Options

The Options page provides the following tabs:

- **System**
- **Buses**
- **Pickoffs**
- **Snapshots**
- **Misc**
- **Interaction**
- **Devices**
- **Plug-Ins**
- Plug-Ins (see [Installing and Authorizing Plug-Ins](#))

System

From the System tab you can configure inputs, Main and Mix buses, reset and shut down your system, lock the system, and get system info.

Settings available in the System tab can only be edited while in Config mode.

 *Changing system settings may restart and/or interrupt audio.*

To change a system configuration option:

- 6 Put the system in Config mode.
- 7 Go to the Options page and select the System tab.
- 8 Select Edit.
- 9 Change a Mains Bus or Mix Bus Configuration, or enable or disable Virtual Soundcheck or Input mode.

 *Select the Cancel button to return to the previous setting.*

- 10 Select Apply to confirm and apply your new settings, or Cancel to cancel the operation.
- 11 Return to Show mode when you are finished editing settings.

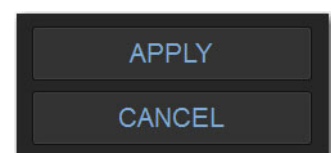
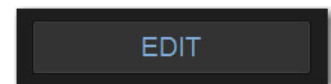

System Configuration

In Show mode, the System Configuration section is display-only, showing the current allocation of system resources and bus settings.

In Config mode, you can edit system settings such as input channel configuration, bus configurations, and hardware I/O configurations.

 *Audio is interrupted when a System Configuration setting is applied. Do not change these settings during a performance.*

 *System configuration settings are stored with Show files. See [System Configurations and Loading Shows](#) for more information.*

Engine

This section shows the following information:

Internal Processing Shows the current sample rate of the S6L system.

HDX Mix Engines Shows the number of HDX TDM cards are installed in the currently paired E6L Engine.

DSPs for Plug-Ins Shows the amount of DSP available for plug-ins is pre-configured, and cannot be changed.

Processing

Input Channels Shows the maximum number of input processing channels available on your system, and is determined by the model of E6L engine your S6L control surface is currently paired with.

Matrixes Shows the number of available Matrix Mixers, and is determined by the model of E6L engine your S6L control surface is currently paired with.

VCAs Shows the number of available VCAs.

Mute Groups Shows the number of available Mute Groups (24).

Graphic EQs Shows the number of available Graphic EQs (32).

System Inputs

This setting lets you globally choose between using Stage inputs or Pro Tools inputs as the source for your system input channels. You can also specify AVB Input or Virtual Soundcheck, or MADI Input or Virtual Soundcheck as the input source. MADI Input or Virtual Soundcheck requires one or more MADI-192 MADI Option cards.

System Outputs

This setting lets you choose AVB, MADI (MADI-192 MADI Option cards), or both as the Virtual Soundcheck Destination.

 See [Pro Tools Recording and Playback](#) for more information.

Mains Bus Configuration

The Mains Bus settings let you choose the overall configuration for the Main buses.

 For instructions, see [Configuring the Mains Bus](#).

Mix Bus Configuration Settings

These options settings let you choose the overall Aux and Group bus configuration.

 For instructions, see [Configuring Mix Buses](#).

System

This section provides the Shutdown, Info (system information export), Update, and Lock buttons. These buttons are also available on the MTS (press the Gear icon, then tap to display the **General** tab).

Info

System Information Export

The System Information Export feature lets you generate an HTML (text) document that details system hardware, software and currently loaded Show file configurations. This document can be read by any Internet browser, such as Internet Explorer, Mozilla Firefox, Safari, or Chrome.



The patch list can also be exported separately (for more information, see [Patch List Export](#)).

The System Information document can be sent directly to production or rental companies to describe your exact system needs; alternately, the information can be re-formatted as desired by copying and pasting the data into a word processing or spreadsheet application.

To export VENUE System Information:

- 1 Insert a USB storage device into any available USB port on the S6L control surface.
- 2 Go to **Options > System**.
- 3 Select the **Info** button.
- 4 Do any of the following:
 - If you have more than one USB storage device connected, make sure the correct USB device is selected. If it is not, select **Next Disk** to cycle through each available disk until the correct one is selected.
 - Select **Save** to proceed and export system info to the selected USB disk.
 - Select **Cancel** to dismiss the dialog without exporting.
- 5 Select **OK** to confirm the export procedure.

You can now remove the USB device —from there, you can transfer the exported file to a personal computer for printing, formatting, archiving or distribution.

Update

The **Update** button is used to perform software updates on your system, and to install ECx Ethernet Control host software. Updates performed using the **Update** button are distinct from System Restores and Software Updates.

Lock

You can lock and hide surface and on-screen controls.

To engage System Lock:

- 1 Go to **Option > Systems**.
- 2 Select the **Lock** button in the System section.
- 3 In the dialog that appears, select **Lock**.

On-screen, an **Unlock** button appears in the lower right corner in front of a dimmed background image.

To unlock the system (disengage System Lock):

- Do either of the following:
 - Press and hold the **Cancel** switch on the S6L control surface for two seconds.
– or –
 - Select **Unlock** in the lower right corner of the screen.



*The **Unlock** button is hidden after a few seconds. Touch the screen, mouse or keyboard to bring it back.*

System Status while Locked

GPI All system GPI inputs and outputs are disabled while the system is locked.

Footswitches All Footswitch inputs are disabled while the system is locked.

Events All Event triggers and actions are disabled while the system is locked.

MIDI and Time Code

While the system is locked:

- Snapshots continue to be recalled via MTC/LTC, either internally or externally generated.
- The system continues to respond to snapshot changes via incoming MIDI program change commands if the Snapshots Respond option is selected on the Options > Snapshots page.
- The system continues to send MIDI program changes when a snapshot is recalled if the Snapshots Send option is selected on the Options > Snapshots page.
- The system continues to send MIDI messages stored within snapshots, provided the MIDI data type is scoped.



MTC/LTC can be disabled using the CHASE MTC/LTC button on the Snapshots page. Also, the sending and receiving of MIDI data can be turned off by deselecting the MIDI options on the Options > Snapshots page.

Customizing the System Lock Display

You can manually add one or more custom images to display during System Lock, rather than the default Avid logo background. Multiple images are displayed one after the other for 20 seconds in a random order. (Pressing the Spacebar advances to the next image immediately.)

To install custom System Lock images:

- 1 Make sure you have connected a keyboard and trackball (or mouse) the S6L control surface.
- 2 Copy a BMP or JPG image file to a USB storage device. (For optimal results image resolution should be 1920x1080; smaller or larger images can be used, but will be centered or scaled, respectively.)
- 3 Put the system into Config mode.
- 4 Go to Options > System, Ctrl-click the ShutDown button, confirm you want to Exit to the Desktop.
- 5 Copy the image from your USB storage device to the following location on the system drive:
User Data(D):\D-Show\Images.



To restore the default Avid logo Lock screen, delete any custom images from the Images folder.

- 6 Double-click the Return to VENUE software icon on the Desktop to restart VENUE software.

Troubleshooting

This section provides the following troubleshooting options:

Clear Console The Clear Console button resets all parameters on all channels to their factory default settings.



Performing a Clear Console also resets the time code start time to the default of 01:00:00:00, and generates a new (default) OnStagePassword.example.txt file.

Run System Test System Test is hardware diagnostics software for the system. Not all versions of VENUE software provide System Test in Options > System.

Only use System Test at the request of a qualified VENUE technician to diagnose specific hardware problems.

VENUE Software

This shows the version of VENUE software currently installed on your S6L system.

Buses

The Buses tab lets you customize characteristics for the Aux, Solo, Matrix, and Main buses.

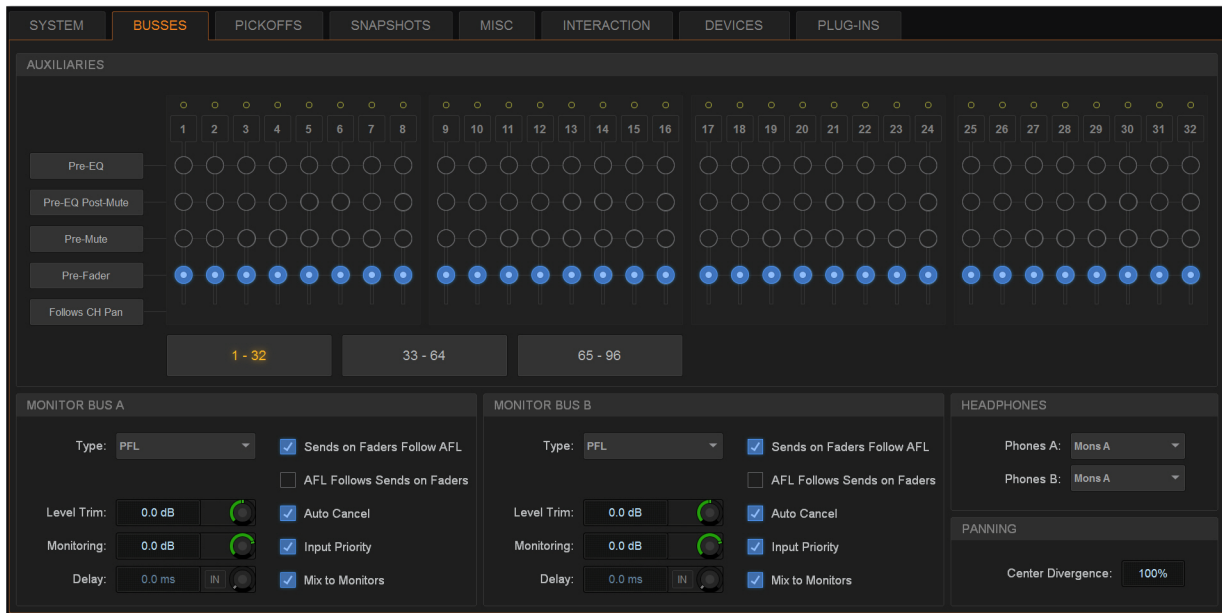

Buses tab of the Options tab

Auxiliaries

These options and indicators let you designate pickoff point of the Aux Sends feeding Aux outputs. Auxes are oriented vertically in columns, and the channel number of the Aux is shown at the top of the column.

Mono/Stereo Indicator Shows whether the Aux output is mono (single yellow circle) or stereo (interlocking green circles). Mono Auxes can be combined into stereo channels using the [Make Selected Mono Strips Stereo/Make Selected Stereo Strip Mono](#).

Pickoffs These options let you designate the pre-fader pickoff point feeding each bus. Choices include Pre-EQ, Pre-EQ Post-Mute, Pre-Mute, and Pre-Fader (post-mute).

Aux Select Buttons These buttons let you access the pickoff options of the Aux outputs indicated on the button. Any Aux outputs currently unavailable are greyed out in the grid.

 For more information on Aux/Variable Group pre-fader pickoff points, see [Selecting Aux Pre-Fader Pickoff Points](#).

Follows Channel Pan Each channel can be panned independently within each stereo Aux, or configured to follow the channel pan by enabling the Follows Channel Pan option.

Solo and Monitor Operations

These settings customize Solo and Monitor bus mode and operation. See [Configuring the Monitor Buses and Solo Options](#) for more information.

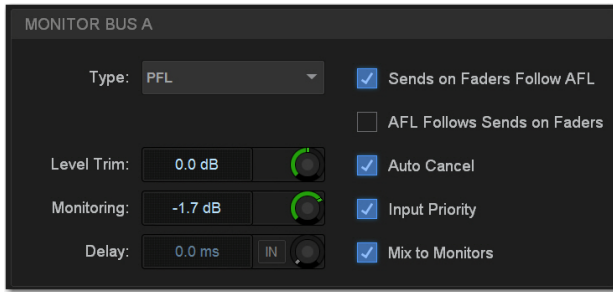

Monitor bus options on the Options > Buses tab

Headphones

These settings let you set the Monitor bus that feeds each S6L control surface front-panel headphone output. With S6L-16C, a single headphone output (Phones) is available.

Panning (Mains Center Divergence)

When the Main buses are set to L–C–R (Left–Center–Right) mode, the Center Divergence setting determines the amount of center-panned signal sent to the center output.

- ◆ When Center Divergence is set to 100%, a channel panned to center is sent to the center output only.
- ◆ When Center Divergence is set to 0%, a channel panned to center is sent equally to the left and right outputs only (phantom center).
- ◆ A Center Divergence setting between 0% and 100% sends a center-panned channel to the left, center, and right outputs with the center channel more prominent as the value increases towards 100%.

To set Center Divergence:

- 1 On the external screen, go to Options > Buses.
- 2 In the Panning section, select in the Center Divergence field and drag up/down to increase/decrease the value (or type in a new value).
- 3 Press Enter or Return on your keyboard to confirm the setting.

Pickoffs

The Pickoffs tab lets you control the bus pickoff point on input strips. The Pickoffs tab also provides master control for Delay Compensation.

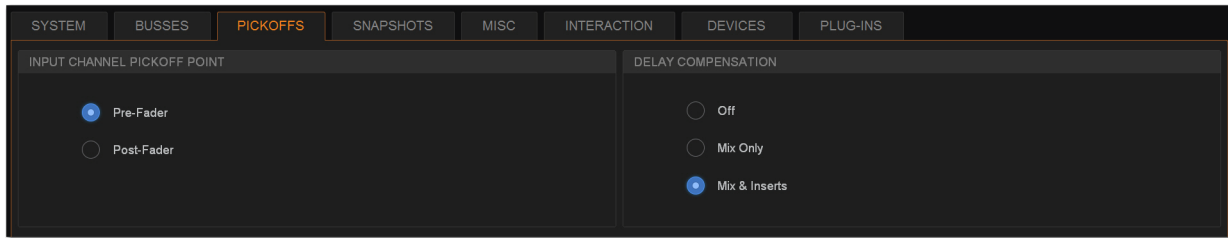

Pickoffs tab of the Options page

Input Channel Pickoff Point

Set the global Input Channel Pickoff Point by selecting Pre-Fader or Post-Fader.

Delay Compensation

Three settings for Delay Compensation are provided, as follows:

 *Delay Compensation can be set in either Show or Config mode.*

Off No Delay Compensation is applied.

Mix Only VENUE automatically compensates for delays incurred by the use of plug-ins.

Mix and Inserts VENUE automatically compensates for delays incurred by the use of plug-ins.

 *When Delay compensation is set to Mix & Inserts, inserts on Auxes will be compensated. This may cause phase issues with some configurations and routing based on legacy (pre-S6L) systems.*

Snapshots

The Snapshots tab provides several snapshot preference settings to optimize snapshot operation.

 For more information on using snapshots, see [Snapshots](#).

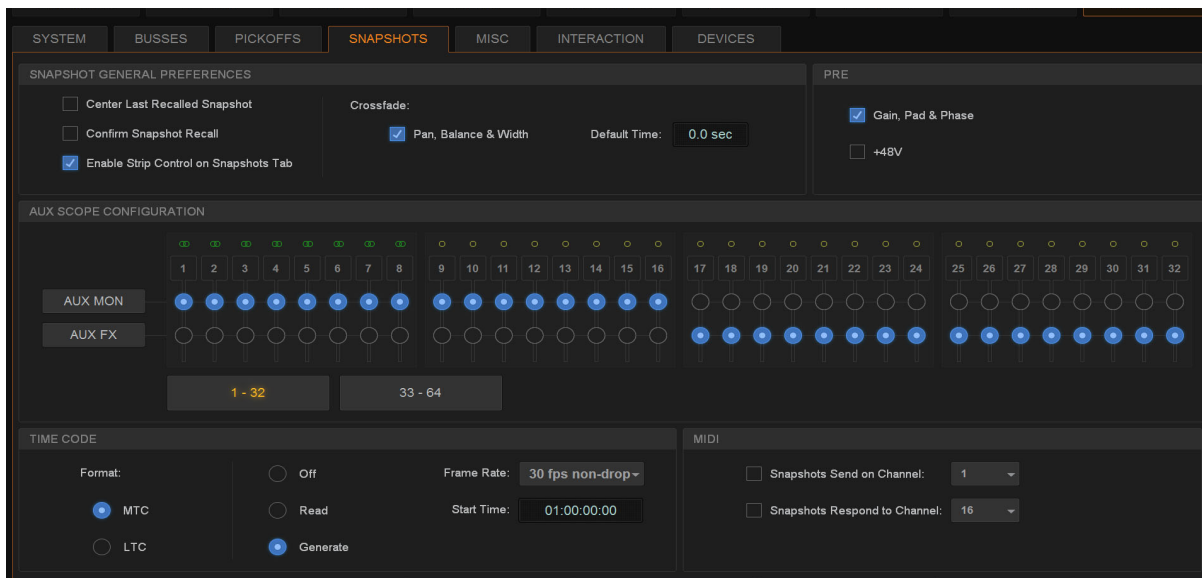

Snapshots tab of the Options page

Snapshot General Preferences

The following settings are available in the Snapshots tab.

Center Last Recalled Snapshot Manages the display of the Snapshots list so that the last recalled snapshot is always centered vertically, letting you maintain display of adjacent snapshots in the list.

Confirm Snapshot Recall When this setting is enabled, a confirmation dialog appears when any snapshot is recalled asking to confirm the operation. When not enabled, recalling snapshots requires no confirmation.

Enable Strip Control on Snapshots Tab Allows adjustment of faders, Solo, Mute, and Safe controls on-screen in the Snapshots tab Channel Strip Controls. Disable this setting to preserve legacy behavior.

Crossfade Pan, Balance, and Width All Pan, Balance and Width parameters follow the default snapshot crossfade time.

Default Crossfade Time Defines the length of time it takes to crossfade between fader levels when recalling snapshots. Maximum crossfade time is 99.9 seconds.

PRE

The options in the PRE section let you specify which parameters are recalled with Snapshots whose scope includes Pre settings. Select to toggle whether recalled Input snapshot data includes the following:

- Gain, Pad, and Phase
- +48V (phantom power)

 Delay is stored as a unique (discrete) data type for each channel.

Aux Scope Configuration

These settings let you classify individual Aux Sends (including linked bus pairs) as monitor sends (“Aux Mon”) or as effects sends (“Aux FX”) as they apply to the Snapshots Data Type Scope buttons.

This option is for organizing Aux Sends for snapshot control only, and does not directly affect Aux bus operation. You can use the **User Aux Scope** tab (Snapshots > User Aux) to include or exclude individual Auxes from snapshots, in addition to their classification as Aux Mon or Aux FX.

Time Code

The Time Code options let you choose the current time code format, operational modes, frame rate, and Start Time.

Format Choose between MTC and LTC for the current time code format. Only one time code format may be selected at a time.

Modes Available time code modes for MTC are **Off**, **Read** (slave), and **Generate** (master). Available time code modes for LTC are **Off** and **Read** (slave).

Frame Rate This option sets the frame rate that is used when generating MTC.

Start Time This option sets the start time that is used when generating MTC (default is 01:00:00:00). When chasing MTC or LTC, make sure the Start Time is earlier than the start of incoming time code.

 See [Synchronization](#) for more information.

MIDI

These settings designate the MIDI channel on which Snapshots send or receive MIDI Bank Select and Program Change information.

Snapshots Send on Channel This option sets snapshots to send Bank Select and Program Change commands on a selected MIDI channel. This provides a quick and easy way to send a MIDI command every time a snapshot is fired, without having to embed a MIDI program change within each snapshot.

Snapshot Send on Channel does not need to be turned on in order to send other types of MIDI data that *are* embedded in snapshots, such as note on/off or MMC.

Snapshots Respond to Channel This option sets snapshots to respond to incoming Bank Select and Program Change commands on the selected MIDI channel.

 See [Synchronization](#) for more information.

Misc

The Miscellaneous (Misc) tab provides utility and other settings.

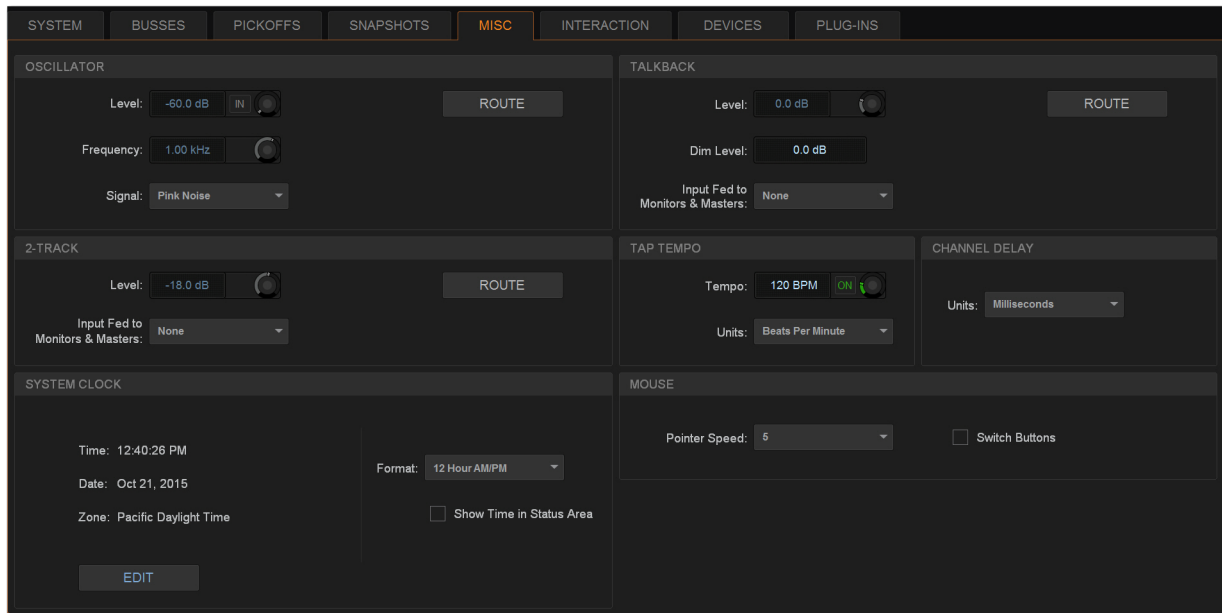

Misc tab of the Options page

Oscillator

The Oscillator provides selectable signal type, frequency (for Variable Sine) and signal level, as well as a master on/off switch. The output of the Oscillator can be patched to input channels using the Patchbay (see [Patching Input Sources to Input Channels](#)), and can be routed directly to output buses using Route to Attentioned mode.

Routing the Oscillator to Output Buses

To route the Oscillator to an output bus:

- 1 Go to the Options page and select the Misc tab.
- 2 In the Oscillator section, select the Route button. The switch flashes to indicate Route to Attentioned mode.
- 3 Go to the Outputs page and attention one or more output fader strips. The attentioned fader strips flash.
- 4 In the confirmation dialog that appears, select Route to confirm your assignment, or select Cancel to cancel without changing the current routing.

⚠ Signals are routed to output buses post-mute and post fader.

Configuring the Oscillator and Setting Level

The Oscillator is configured on-screen, and can be activating on-screen or from the Global Control encoders.

To configure the Oscillator:

- 1 Go to Options > Misc.
- 2 As a precaution, drag the on-screen Level encoder in the Oscillator section to set the Oscillator level to off before you go any further.

- 3 Select the Signal pop-up and select from the following signal types:
 - 100 Hz Sine
 - 1 kHz Sine
 - 10 kHz Sine
 - Variable Sine
 - Pink Noise
 - White Noise
- 4 If you select Variable Sine, you can set the sine wave frequency with the on-screen frequency control (directly to the right of the Signal pop-up).
- 5 Select the on-screen In button to activate the Oscillator.
Oscillator level appears on the Console Assignable Encoder whenever the Oscillator is In. If Talkback is engaged, it replaced the Oscillator on the Assignable Encoder.
- 6 Slowly drag the on-screen Level encoder to set the Oscillator level.

Talkback

You can route a single Console analog input directly into any output bus using the Talkback circuit. This allows you to send Talkback to outputs (such as Auxes feeding stage monitors) without having to use a system channel.

Routing Talkback to Output Buses

To route Talkback to an output bus:

- 1 Go to Options > Misc.
- 2 In the Talkback section, select the Input Fed to Monitors and Masters pop-up and choose a hardware input source.

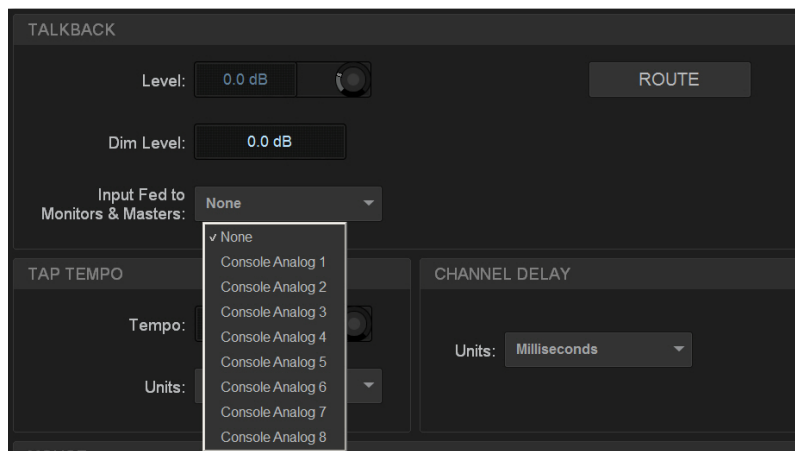

Choosing a Talkback input

- 3 Select Route. The switch lights to indicate Route to Attentioned mode.
- 4 Go to the Outputs page and attention one or more output fader strips. The attentioned fader strips flash.
- 5 In the confirmation dialog that appears, select Route to confirm your assignment or select Cancel to cancel without changing the current routing.

⚠ *Signals are routed to output buses post-mute and post-fader.*

Activating Talkback Input and Setting Level

Talkback can be adjusted on-screen, or from the Assignable Encoder on the MLM.

To activate and set the level for Talkback input on-screen:

- 1 Go to Options > Misc.
- 2 Select the on-screen In button in the Talkback section to activate the Talkback input.
- 3 Drag the on-screen Level knob to set the Talkback level.



You can designate a footswitch, Function switch or other triggers to control Talkback. For more information, see [Events](#).

To activate and set the level for Talkback from the MLM:

- 1 In the Assignable Encoder (Touch and Turn) section of the MLM, press and hold the **Talkback** switch.
- 2 Rotate the Assignable Encoder to adjust Talkback level.

Setting Talkback Dim Level

When Talkback is sent directly to an Output bus, the bus program material (minus the Talkback signal) is automatically reduced by the amount specified in the Dim Level setting.

To set the Talkback Dim Level:

- 1 Go to Options > Misc.
- 2 In the Talkback section, double-tap the Dim Level text box and enter a Dim Level value in the range –60 dB (maximum gain reduction) to 0 dB (no gain reduction).

2-Track Inputs

You can route a pair of Console or Engine analog or digital hardware inputs directly into output buses using the 2-Track inputs. This allows you to send audio to the selected outputs without using a system channel. Use this feature to perform tasks such as confirming system audio output.

Routing 2-Track to Output Buses

To route 2-Track inputs to output buses:

- 1 Go to Options > Misc.
- 2 In the 2-Track section, select the Input Fed to Monitors and Masters pop-up and choose a hardware input source.
- 3 Select Route. The switch flashes to indicate Route to Attentioned mode.
- 4 Go to the Outputs page and attention one or more output fader strips. The attentioned fader strips flash.
- 5 In the confirmation dialog that appears, select Route to confirm your assignment or select Cancel to cancel without changing the current routing.

Activating 2-Track Input and Setting Level

The 2-track input can be adjusted on-screen or from the Global Control encoders.

To activate and set level for the 2-Track inputs on-screen:

- 1 Go to Options > Misc.
- 2 In the 2-Track section, select the on-screen In button to activate the 2-track input.
- 3 Drag the on-screen Level knob to set the level.

Talkback, 2-Track and Oscillator States When Loading Shows

When you load a Show file, Talkback, 2-Track and Oscillator controls are set to off (deactivated), regardless of their state when the Show was last saved.

Tap Tempo

This section lets you enable and adjust the settings for Tap Tempo. Tap Tempo lets you quickly establish a system tempo to use as a beat clock for delay and echo plug-ins that support Tempo Sync.

 See [Tap Tempo for Plug-ins](#) for more information.

Channel Delay Unit Display

This section lets you set the display units on all applicable input and output delay controls. This makes it possible to set the delay based on any of the following:

- delay time (in milliseconds)
- distance to the source (in feet or meters)
- number of samples of delay

System Clock

This section lets you set the date and time for the system, as well as display preferences. See [Setting the System Clock](#) for instructions.

 *Changing the system clock while using a timed iLok license (for a plug-in with a demo period, or for a plug-in rental) may expire the plug-in authorization.*

 *The system clock setting can affect data synchronization with portable storage devices. See [Synchronizing Settings, Shows and Presets](#).*

Show Time in Status Area

You can choose to show time of day in the lower right corner of the screen in the Status display area.

To show time of day in the Status area:

- 1 Go to Options > Misc.
- 2 In the System Clock section, enable the Show Time in Status Area option.
- 3 Choose a format for the displayed time: 12 hour (AM/PM) or 24 hour.

Time of day is shown whenever the status of the plug-in racks is OK; plug-in rack status messages (if any) temporarily replace time of day display to alert you to plug-in rack status.

Mouse

Pointer Speed and Mouse L/R Settings

This section lets you customize the response speed for the trackball (or mouse) and on-screen cursor, and reverse the left/right assignment of the Trackball buttons, from the Options > Misc page.

To customize Pointer Speed:

- 1 Go to Options > Misc.
- 2 Do any of the following:
 - To adjust cursor speed, select the Pointer Speed pop-up menu and choose a higher value for faster response, or a lower value for a slower response.
 - To reverse the left/right assignment of the two Trackball buttons, select Switch Buttons.

Interaction

The Interaction tab lets you configure behaviors for attentioned and selected channels the Channel Safe Switches; light bar, OLED and touch screen brightness; Metering; Ethernet Control and VENUE Link network settings; and Flex Channels and VCA configuration.

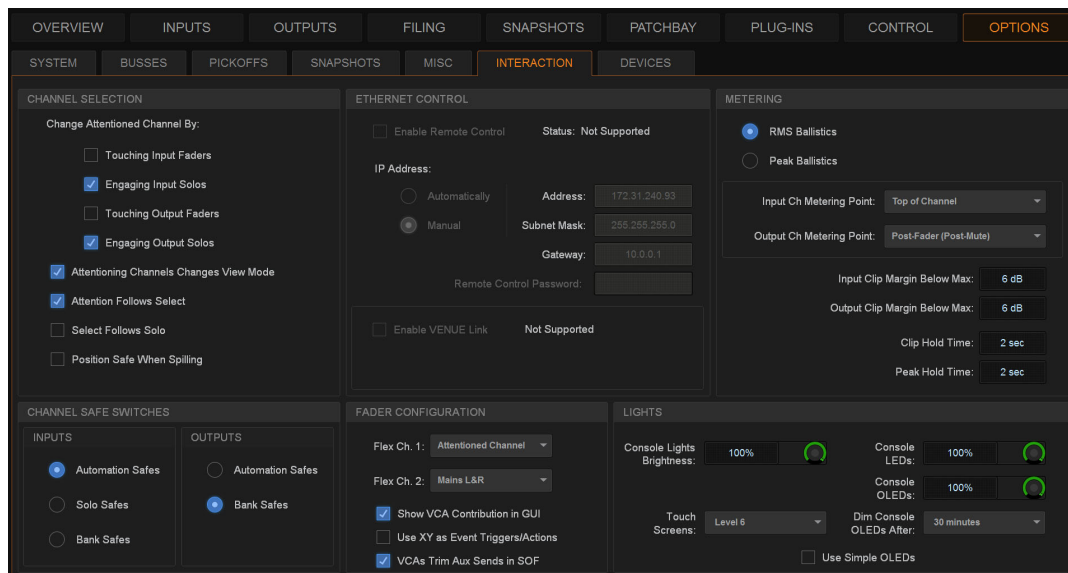

Interaction tab of the Options page (S6L-32D/24D)

Channel Selection

Options in this section determine how channels are attentioned on the external screen and the MTS.

To customize control surface and screen interaction:

- 1 Go to the Options page and select the Interaction tab.
- 2 Set the following Channel Selection options:

Change Attentioned Channel By Let you specify how a channel is attentioned on the external screen and the MTS. Select any or all of the following options:

- Touching Input Faders
- Engaging Input Solos
- Touching Output Faders
- Engaging Output Solos

Attentioning Changes View Mode When selected, updates the on-screen display to show the page for the currently attentioned channel. When this option is deselected, the on-screen display does not update when a channel is targeted.

Attention Follows Select When selected, any channel that is selected using the channel strip **Select** switch is also attentioned, and is the default setting. When deselected, select and attention are decoupled.

Select Follows Solo When selected, engaging Solo on any channel that is currently banked to the faders also selects that channel. Solo can be engaged from the CFM, MTS, or external screen, but the channel must already be banked to the control surface to engage local Select.

Position Safe When Spilling When enabled, spilling a VCA, Aux, Group, or Matrix leaves the “master” (the channel from which you initiated spill) in place on the surface, and spilled channels spill around the master. In effect, a “Spill Safe” state for the VCA, Aux, Group, or Matrix. You can unspill by pressing Attention on that master strip. When not enabled, spilling a VCA, Aux, Group, or Matrix replaces channels on as many strips as needed for the spill, except for any Bank Safed strips.

Meters Follow Selection (S6L-24C Only) When the MTS is in Meters View it shows the channels on the faders directly below it (OLEDs on those strips show a Selection outline). By default, Meters view on the 24C follows the Selected channel. You can change this behavior to instead have the MTS Meters view be associated with whichever strips are banked below the MTS. This setting is only available when using an S6L-24C control surface.

- When enabled, Meters View on the S6L-24C MTS associates with the bank of channels that has a channel selected locally.
- When not enabled, Meters View associates with the faders directly below the MTS.

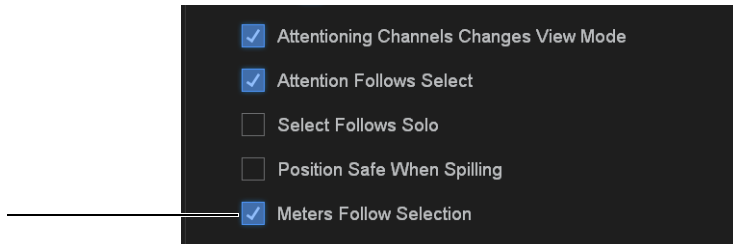

Meters Follow Selection setting in Options > Interaction on S6L-24C (only)

Ethernet Control

Ethernet Control settings let you configure the following:

ECx Network Settings These settings let you configure ECx Ethernet Control to remotely control of your system over a wired or wireless Ethernet network. See the *ECx Ethernet Control Guide* for more information.

VENUE Link Settings These settings let you configure VENUE Link to integrate a Pro Tools system with VENUE. For more information, see the *S6L Live Recording Guide.pdf*.

Metering

The following display options can be configured for meters. These options affect the 16 channel meters on the S6L control surface and on-screen.

Meter Ballistics

This option lets you choose RMS or Peak ballistics for the control surface and on-screen meters.

RMS Ballistics (Default) Meters follow the characteristics of a damped analog meter. In this mode, meter response and decay is slower than in Peak mode, providing an average reading of the metered signal. A single LED shows the peak level for the designated Peak Hold Time.

Peak Ballistics Meters follow the characteristics of a standard peak meter. In this mode, meter response is instantaneous, showing the true peak level of the metered signal.



You can set Pro Tools metering to mirror VENUE metering. [Pro Tools Recording and Playback](#)

Metering Points

These options let you choose the point in the signal path where the signal is picked off for metering input and output channels.

Input Channels Metering Point Choose one of the following options to set the input channel metering point:

- Top of Channel
- Insert Return
- Post-Fader (Post-Mute)

Output Channels Metering Point Choose one of the following options to set the output channel metering point:

- Top of Channel
- Post-Fader (Post-Mute)

Clipping Indication

VENUE meter clip indicators are proximity warnings that show when an input or output signal reaches or exceeds the configured Clip Margin.

Clipping can occur at several points throughout the signal chain. A clip at any one of these points is indicated by lighting the top LED red on the meter. For more information on the location of clip detect points, refer to Chapter 26, “Signal Flow Diagrams.”

Clip Margin Lets you configure the amount of headroom you want before clipping indication begins. Clip Margin is expressed as *dB below maximum* (where maximum is a peak level of +20 dB VU).

Clip Margin can be set within a range of 0 dB to 30 dB below maximum, and is configured separately for inputs and outputs.

To set the Clip Margin:

- 1 Go to Options > Interaction.
- 2 Under Meter, enter values for Input Clip Margin Below Max and Output Clip Margin Below Max.
- 3 Press Enter to confirm the setting.

Clip Hold Time

The Clip Hold Time determines how long a clip indication lasts after the last clipped signal. Clip Hold Time can be set within a range of 0–20 seconds.

To set the Clip Hold Time:

- 1 Go to Options > Interaction.
- 2 Under Meter, enter a value for the Clip Hold Time.
- 3 Press Enter to confirm the setting.

Channel Safe Switches

These options set the global Safe Mode that is enabled when you press a Channel **Safe** switch on the control surface, or select the Channel Safe button on an external screen Inputs/Outputs page, and can be set to one of the following modes:

Automation Safes Lets you suspend the effect of snapshots on all parameters of the channel. See [Automation Safing Channels](#).

Solo Safes (Input Channels Only) Prevents that channel from being implicitly muted when any other channel is soloed. See [Soloing Channels](#).

Bank Safes Temporarily “locks” the location of key channels (such as a lead vocal or the Mains) on an S6L control surface channel strip. See [Bank Safing Channels](#).



You can use Events to program a Function switch or other trigger to cycle through Input and Output Safe Switch modes. For more information see [Events](#).

Fader Configuration

Configuring Flex Channels

The Flex Ch.1 and Flex Ch.2 pop-up menus provide the following options for each Flex Channel:

Mains L&R Assigns the Mains L-R output to the Flex Channel, and is the default setting for Flex Channel 2. If the Mains L-R are unlinked, you can target each Mains L and R bus individually on the Flex Channel by pressing the **Attention** switch on the corresponding Flex Channel. The currently targeted Mains bus is indicated in the corresponding display. Solo is inoperable for Mains when they are assigned to the Flex Channel.

Mains C/Mono Assigns the C/Mono output to the Flex Channel. Solo is inoperable for Mains.

Monitor Bus A Assigns level control for Monitor Bus A to the Flex Channel. This can be useful for monitor mixing workflows.

Monitor Bus B Assigns level control for Monitor Bus B to the Flex Channel.

Attentioned Channels Assigns the currently attentioned channel to the Flex Channel, and is the default setting for Flex Channel 1. Double-pressing a channel strip **Attention** strip “latches” that channel to the Flex Channel, until it is unlatched by another double press.

Show VCA Contribution

This option lets you display a secondary, transparent fader cap on each on-screen fader strip that represents the effective channel gain (channel gain plus associated VCA gain, if any). For more information, see [Working with VCAs](#).

Use XY as Event Triggers/Actions

This option lets you reconfigure the channel **X** and **Y** switches to become available Triggers and Actions for Events. In their default configuration, the **X** and **Y** switches in each channel strip toggle the corresponding Expander/Gate and Compressor/Limiter on/off, respectively. When this option is enabled, the channel **X** and **Y** switches become available in the Switch (Type) list in the Trigger properties Control Surface sub-menu and will no longer toggle their corresponding dynamics processor on/off, even if they are not yet included in the definition of any specific Event.

VCAs Trim Aux Sends in SOF

This option lets you use VCAs to trim Aux send levels. By default this option is enabled. For more information, see [VCAs Trim Aux Sends in Sends on Faders Mode](#).

Lights

Console and LED/Display settings let you adjust the brightness of the following items:

Lightbar Brightness (S6L-32D/24D) Adjusts the brightness of the built-in lightbar

Console Lamp Brightness (S6L-24C/16C) Adjusts the brightness of any console lamps connected to the top-panel lamp connectors.

Lightbar Color Adjusts the color of the built-in lightbar.

Dim Consoles OLEDs After Automatically dims the OLED displays on the control surface after the interval selected in the pop-up menu.

 *Touch any control on the control surface to undim the displays.*

Touch Screens Adjusts the brightness of the MTS and any CTMs.

Consoles LEDs Adjusts the brightness of the switch and encoder LEDs on the control surface.

Consoles OLEDs Adjusts the brightness of the OLED displays on the control surface.

Use Simple OLEDs Optimizes channel strip displays for easier viewing of channel name.

- When enabled, channel strip displays show channel Name, as well as Attention, Select, Sends on Faders and Flip status but do not show channel numbers, hardware assignment, or level. When a fader is touched or moved, the fader value is displayed under the channel name for as long as the fader is touched or in motion. The display of fader value times out after two seconds of not being touched or moved. (Value is never shown when in Sends on Faders mode or Flip modes).
- When not enabled, channel strip displays show the complete set of channel information.

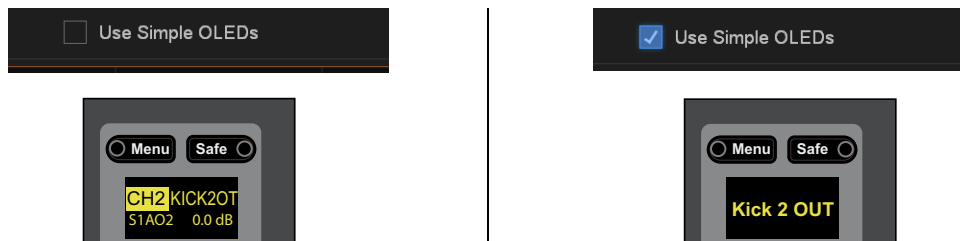

Channel display with Use Simple OLEDs disabled (at left) and enabled (at right)

Devices

The Devices tab lets you view and edit system connections, edit hardware settings, provides troubleshooting and diagnostic options, and provides network information.

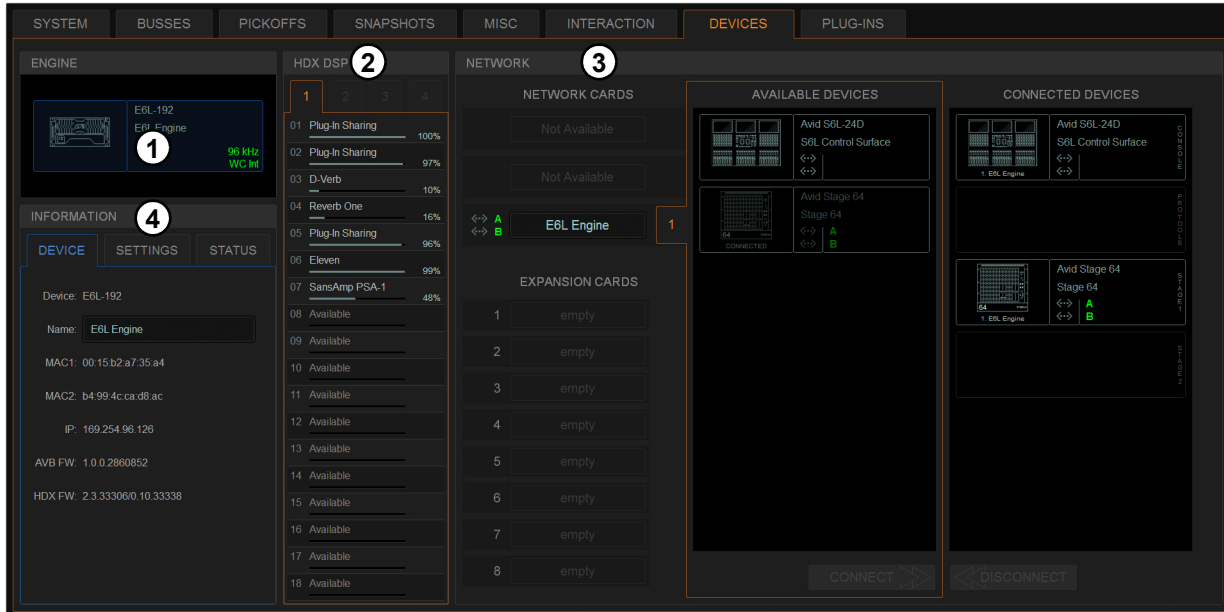

Devices tab of the Options page

1 – Engine

This section shows the E6L engine that is currently paired to the S6L control surface (and any other E6L engines detected on the network). The current sample rate and word clock status (internal or external) is shown.

2 – HDX DSP

This section shows the DSP usage of the HDX TDM Mix Engine cards currently installed in the E6L engine.

To view a card's DSP usage:

- Select a card number 1–4 to view that card's DSP usage.

3 – Network

This section shows the devices currently connected to the AVB audio network, and cards currently installed in the E6L engine.

Network Cards

This section shows the three AVB-192 Network card slots in the E6L engine, and the AVB-192 Network cards that are currently installed in them. You can manage and view the devices that are connected to each card, and give each AVB-192 Network card a unique name.

To view and manage the devices connected to an AVB-192 Network card:

- Select a Network card. Devices available for connection are shown in the Available Devices column, and currently connected devices are shown in the Connected Devices column. For example, select Ring 1 to see control surface and Stage I/O devices. Select Ring 2 to see Local 16s (if any)

To rename an AVB-192 Network card:

- Double-tap a Network card, then enter a name.

Available Devices

This section shows the devices that are available to be connected to the selected Network card. A device is dimmed if that device has already been assigned via another AVB-192 Network card in the currently paired E6L engine. Available Stage I/O devices are assigned using the CONNECT button.



For additional information and requirements, see [Managing Stage I/O Unit Connections](#).

To connect a device:

- 1 Enable Config mode.
- 2 In the Available Devices list, select a device.
- 3 Select the Connect button at the bottom of the Available Devices column.
- 4 In the Connected Devices column, select a flashing Stage slot to assign that device to that Stage slot.

Connected Devices

This section shows the devices that are currently connected to the selected Network card in the Network Cards section. Assigned Stage I/O devices are unassigned using the DISCONNECT button.

To unassign (disconnect) a device:

- 1 Enable Config mode.
- 2 In the Connected Devices column, select the Stage I/O device you want to unassign so it is outlined in blue.
- 3 Select the Disconnect button at the bottom of the Connected Devices column.

4 – Information

This section shows information for the device that is currently selected in the Devices page, as follows:

DEVICE Shows the device type, the assigned name (which can be changed), MAC address(es), IP address, and device firmware versions (where applicable).

SETTINGS Shows device settings for the E6L engine and Stage I/O devices as follows:

- For E6L, the current sample rate is shown.
- For Stage 64 and Stage 32, shows the I/O cards currently installed in each slot. You can also set MADI Out sample rate (see [Configuring Stage 64 and Stage 32 MADI Outs](#)), and enable DSI-192 card ADAT inputs (see [Enabling ADAT Inputs](#)).

Status Provides hardware monitoring information, such as internal temperature and voltage.

To rename a device:

- 1 Select a device on the Devices page.
- 2 Select the DEVICE tab.
- 3 Double-tap the Name field, and enter a new name.
Device names are stored with the device (they are not saved or included in Show files). Custom names for Stage units are displayed in the Patchbay.

Configuring Stage 32 Settings

Unlike Stage 64 and Stage 16, Stage 32 slots can be used for input or output cards. The only restriction is that all input cards must be installed in lower-lettered slots and physically above output cards. For example, in a base configuration Stage 32 the three input cards are in slots A, B, and C, while one output card is in Slot D.

If your Stage 32 includes one or two DNT-192 Dante Network cards, configure the Stage 32 and each Dante card in the Devices tab for 16-in or 16-out operation. Note that if any output card (SRO-192 or DSO-192) is installed in a lower-lettered slot the DNT-192 will auto-configure to 16 channels of output (this cannot be changed). If input cards (or another DNT-192 card) are in lower-lettered slots, do the following to configure the DNT-192 card.

To configure Stage 32 DNT-192 Dante I/O:

- 1 Make sure the system is in Config mode.
- 2 Select the Stage 32 in the AVAILABLE DEVICES column. If the Stage 32 is listed in the CONNECTED column, select it and choose DISCONNECT to make it available in the AVAILABLE column.
- 3 In the INFORMATION section display the SETTINGS tab.
- 4 Use the selector at the bottom of the SETTINGS tab to configure the Stage 32 for the desired input/output arrangement (All Outputs, One Input, Two Inputs, Three Inputs, or All Inputs).

For example, in its base configuration Stage 32 includes three input cards and one output card. If you have removed the input and output cards in slots C–D and replaced them with a single DNT-192 Dante card which you want to use for 16 channels of Dante output, select Two inputs.

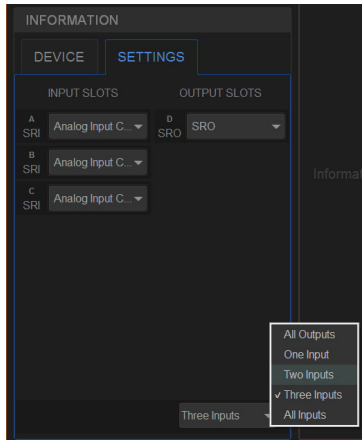

Configuring Stage 32 I/O in Options > Devices, Settings tab

- 5 In the OUTPUT SLOTS column that appears, use the selector for port C to choose Dante Output Card. Slots C and D populate with Dante Output Card channels (1–8, and 9–16). To use this same Dante card for 16 channels of Dante input, repeat the above steps but configure the Stage 32 for All Inputs, then select Dante Input Card for (Input) slot C.

Managing I/O from the Devices Page

You can identify connected Stage I/O devices and mute Stage and S6L control surface outputs from the Devices page.

Identifying Stage I/O Devices

The Identify button on an on-screen Stage device icon lets you identify the corresponding physical Stage unit.

To identify a connected Stage 64:

- 1 Select a Stage I/O unit on the Devices page.
- 2 Select the DEVICE tab.
- 3 Select the Identify button to latch the button on. The Identify button on-screen flashes, and the Power and Status LEDs on the front panel of the corresponding Stage unit flash.

Muting Stage and S6L Control Surface Outputs

The Mute button on the Devices tab lets you mute all the outputs on connected Stage I/O units or the S6L control surface.

To mute the outputs of a Stage unit or S6L control surface:

- 1 Select a device on the Devices page.
- 2 Select the DEVICE tab.
- 3 Select MUTE. The Mute switch flashes while the outputs are muted, and the Mute LEDs on the Stage units or the S6L control surface light solid red.

When engaging Global Mute on systems configured for I/O sharing:

- If only one E6L engine has claimed the Output slots in the selected Stage unit, all Outputs on the selected device are muted.
- If more than one E6L engine has ownership of Output slots in the selected Stage unit, the following dialog appears:

MUTE <Stage number>

MUTING this stage device will Mute outputs claimed by another E6L engine <user defined name>, are you sure you want to MUTE this device?

Select OK to proceed and mute all outputs. Or select Cancel to cancel without affecting any outputs.

When a Stage 64 is muted manually from the Stage 64 front panel, all outputs are immediately muted and no confirmation dialog or choices are presented.

AVB Network Card Port A and B LEDs

On-screen LEDs are provided on the Devices page to indicate the status of the physical A and B Network ports on each S6L system component (S6L control surface, E6L engine, and Stage I/O units), as follows:

LED Color	Network Port Status
Green	The port is connected and has a valid connection to another device.
Amber	This port is connected and is part of a non-redundant daisy-chain.
Red flashing	The port has lost a connection with a device. When canceled via dialog box, it turns off.
Off	This port does not have a connection with a device. For example, it is a device at the end of a non-redundant daisy-chain.

Plug-Ins

The Plug-Ins tab of the Options page is used to install plug-ins on the system. The Plug-Ins tab is not available in the VENUE Standalone software.

 See [Installing and Authorizing Plug-Ins](#).

Part IV: Recording and Playback

Pro Tools Recording and Playback

VENUE | S6L systems provide direct connection to up to two computers running Pro Tools software via AVB Ethernet. The Ethernet AVB connection between your S6L system and Pro Tools provides up to 128 channels of simultaneous Pro Tools I/O. No additional audio hardware is required to connect your S6L system to Pro Tools.

- This single Ethernet connection lets you record multi-track Pro Tools sessions of performances using a variety of S6L system audio sources, including digital splits of your Stage inputs, channel Direct Outputs, and bus outputs.
- You can also play back multi-track audio from Pro Tools through your S6L system to integrate pre-recorded tracks with your live mix, or to monitor your Pro Tools recording on your S6L system. When VENUE Link is enabled, the same connection also lets you control the Pro Tools Transport from the S6L control surface.
- By combining recording and playback features, you can perform a true Virtual Soundcheck. Play back the tracks from a previous performance, adjust the mix, and have the changes remain when you switch back to your live mix.

You can connect up to two Pro Tools systems, using S6L control surface Network ports **C** and **D** for fully redundant recording and Virtual Soundcheck:

Redundant Recording On both Pro Tools systems, enable VENUE Link and use Create Session from VENUE to be able to record your performance to both Pro Tools systems simultaneously (fully redundant recording of up to 128 tracks). By enabling VENUE Link on both systems, both Pro Tools systems respond as one to Transport commands from S6L.

Virtual Soundcheck When you switch the S6L system Input Source to Pro Tools to perform a Virtual Soundcheck, playback will be available from the Pro Tools computer that was connected to the E6L engine *last* in AMS. When VENUE Link is enabled on both Pro Tools systems they will both play back and cue in response to Transport commands from S6L, but audio from the first-connected Pro Tools system will not be available (only audio from the last-connected Pro Tools system is recognized by S6L).

Simultaneous Record/Playback If you need to simultaneously record to and play back from Pro Tools to integrate backing tracks, count-offs or other material, use a single Pro Tools system connected to S6L Network port **C**, only.

For complete instructions on integrating Pro Tools recording and playback with your S6L system see the *S6L Live Recording Guide.pdf*, available for download from your [Avid account](#) and from the [S6L Documentation](#) article on our Knowledge Base.

Pro Tools Compatibility

Avid can only assure compatibility and provide support for hardware and software it has tested and approved.

For complete system requirements and a list of qualified versions of Pro Tools software, computers, operating systems, hard drives, and third-party devices, visit:

www.avid.com/S6Lsupport

Important Requirements and Optimizations for a Mac with Pro Tools AVB

Make sure your AVB-compatible Mac and other equipment is qualified to support 128 Channel AVB with Pro Tools. For complete compatibility requirements and optimization recommendations, see [System Requirements for Pro Tools with S6L](#).

Do the following to optimize your Mac for 64- or 128-channel AVB recording and playback:

- Disable Wi-Fi, Airport, and Blue Tooth, and turn off Internet Sharing
- Disable Blue Tooth
- Turn off Energy Saving
- Disable Notification Center

Part V: Reference

Synchronization

This section describes how to synchronize S6L with external digital devices, and how to incorporate time code in your performances.

Clock Synchronization Overview

Whenever two digital audio devices are connected together, care must be taken to ensure they are properly synchronized or the audio will suffer from clicks, pops and distortion (even if the devices are operating at the same sample rate).

In simple configurations where you are synchronizing a single external device with a single S6L system, the device providing source audio can serve as the master clock source, or the S6L system serve as the master clock source. In this type of simple configuration you can use word clock, or you can synchronize your external device to the AES, ADAT, or MADI stream coming from the S6L system.

In configurations where more than two digital devices are being connected, *distributed* word clock should always be used. In these types of more complex configurations, use dedicated, “distributed” word clock connections from the master (or “house”) clock source to each device.

 *Do not “daisy-chain” word clock among multiple devices. Use a distributed word clock configuration.*

S6L clock synchronization capabilities include the following:

Word Clock You can sync external digital devices to your S6L system or sync your VENUE system to external digital devices, such as a master (or “house”) clock or another digital console, using word clock. For instructions, see [Synchronizing External Devices using Word Clock](#).

Digital Audio (AES/ADAT, or MADI) S6L AES/ADAT and MADI outputs can be used as the clock source for compatible external devices (the external device must support syncing to these types of signals).

- You can utilize AES/ADAT clocking to sync external devices to S6L AES/ADAT outputs from the S6L control surface or Local 16, or from DSI-192 Option cards, if any, installed in Stage 64 or Stage 32. See [Synchronizing using AES/ADAT or MADI Clock](#).
- You can utilize MADI clocking to sync external devices to MADI outputs from Stage 64 or Stage 32, or from MADI-192 Option cards (if any). MADI clocking requires high-quality MADI cables and other additional guidelines, especially in I/O Sharing configurations. See [Using MADI Audio to Synchronize a Single External MADI Device to S6L](#).

For best performance, or if in doubt about the capabilities of your external devices, use word clock to synchronize S6L with external digital devices.

Time Code Overview

S6L also provides a set of synchronization features that allow automation and remote control of snapshots and triggering of external devices when snapshots are recalled via SMPTE MIDI Time Code (MTC) or Linear Time Code (LTC). For more information, see [Time Code](#).

Synchronizing External Devices using Word Clock

You can sync external digital devices to your S6L system, or sync your S6L system to external digital devices, using word clock.

Syncing External Devices to an S6L System using Word Clock

You can use either the [E6L Word Clock Out](#), or a [DSI-192 Word Clock Out](#) (if your system includes any DSI-192 cards) to supply word clock to external devices. When doing so, always observe the following guidelines:

- When using a single S6L system (non-I/O Sharing) never connect more than one S6L component Word Clock Out port to external devices. If you need to sync multiple external devices to S6L, use a distributed word clock source (do not daisy-chain). See [Using a Distributed External Master Clock to Synchronize Multiple Devices](#).
- The external device must be configured to sync to the word clock signal from S6L.
- If your system includes one or more MADI-192 MADI Option cards, never connect their **Word Clock Out** ports.
- When multiple S6L systems are configured for I/O sharing, see [Important: Synchronization in Shared I/O Configurations](#).

E6L Word Clock Out

- Connect a coaxial cable from the **Word Clock Out** on the E6L engine back panel to the word clock input on the external device. Set the external device to sync to the word clock signal coming from the VENUE system.

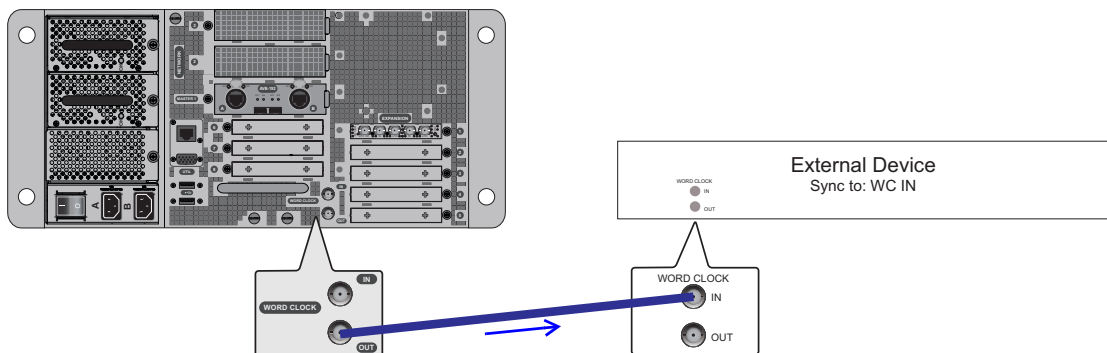

External device connected and configured to sync to incoming word clock, supplied by E6L Word Clock Out

DSI-192 Word Clock Out

- If your system includes a DSI-192 card, connect a coaxial cable from the **Word Clock Out** port on the card to the word clock input on the external device. Set the external device to sync to the word clock signal coming from the VENUE system.

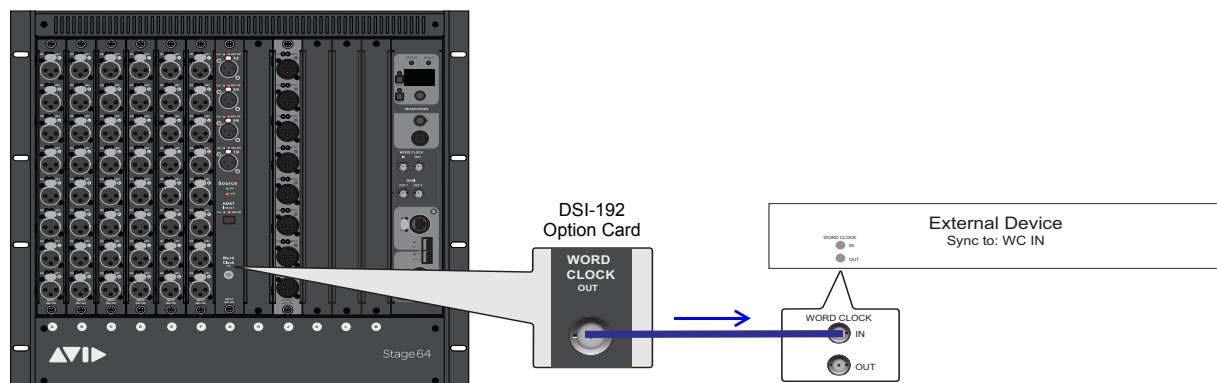

External device connected and configured to sync to incoming word clock, supplied by DSI-192 Word Clock Out



At the time of this writing the built-in Stage 64 Word Clock connectors are not supported. Use the Word Clock Out on the DSI-192 only.

Syncing an S6L System to an External Device using Word Clock

The S6L system automatically syncs to external word clock when connected to an external device sending a valid word clock signal. If the external word clock signal is interrupted, the S6L system defaults back to its internal word clock.

⚠ Only the E6L **Word Clock In** port should ever be connected to an external word clock source. Never use the **Word Clock In** port on the Stage 64. If utilizing I/O sharing, be sure to follow the guidelines explained in [Important: Synchronization in Shared I/O Configurations](#).

To sync the S6L system to an external device using word clock:

- 1 Make sure the outgoing word clock rate of the external device is set to match your VENUE system word clock rate.
- 2 Connect a coaxial cable from the word clock out port on the external device to the **Word Clock In** port on the E6L engine.
When a valid word clock connection is recognized by the S6L system EXT is indicated in the Status box, and WC Ext also appears next to the graphic of the currently paired E6L engine on the external screen Options > Devices page. That E6L becomes the S6L Media Clock Master.

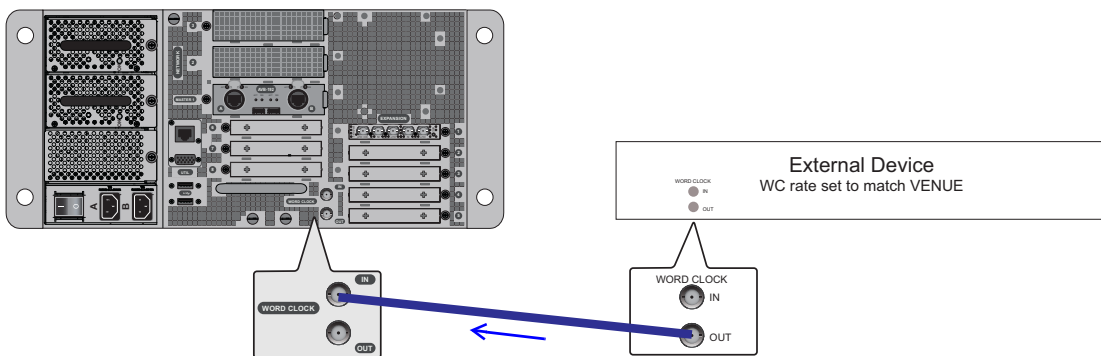

External device connected and configured to provide word clock to S6L via the E6L Word Clock In

Important: Synchronization in Shared I/O Configurations

E6Ls in shared I/O configurations can send and receive word clock, letting you sync external devices to your networked S6L system. However, only *one* E6L engine should ever be connected to an external word clock device.

I/O sharing configurations should be thought of as a single “system” in terms of clock. When you connect two E6L engines together (where two S6L systems are sharing one or more Stage I/O units in a shared I/O configuration), only one of the E6L engines should ever be connected to an external word clock device. This E6L engine then becomes the Master clock for the entire dual-system configuration and distributes clock to all other S6L devices. If no external word clock device is connected, the E6L that comes online first becomes the Master clock for the entire system.

⚠ Never connect word clock from one engine to the other when sharing I/O, and always make sure that only one E6L engine's word clock input is connected if using an external word clock when sharing I/O.

See the following two sections for instructions and examples:

- [Syncing an External Device to S6L Word Clock when Configured for I/O Sharing](#)
- [Syncing S6L to External Word Clock when Configured for I/O Sharing](#)

Syncing an External Device to S6L Word Clock when Configured for I/O Sharing

To sync an external device to S6L when configured for I/O sharing:

- Connect a BNC cable from a **Word Clock Out** port on one or both E6L engines on the network to the external device(s).

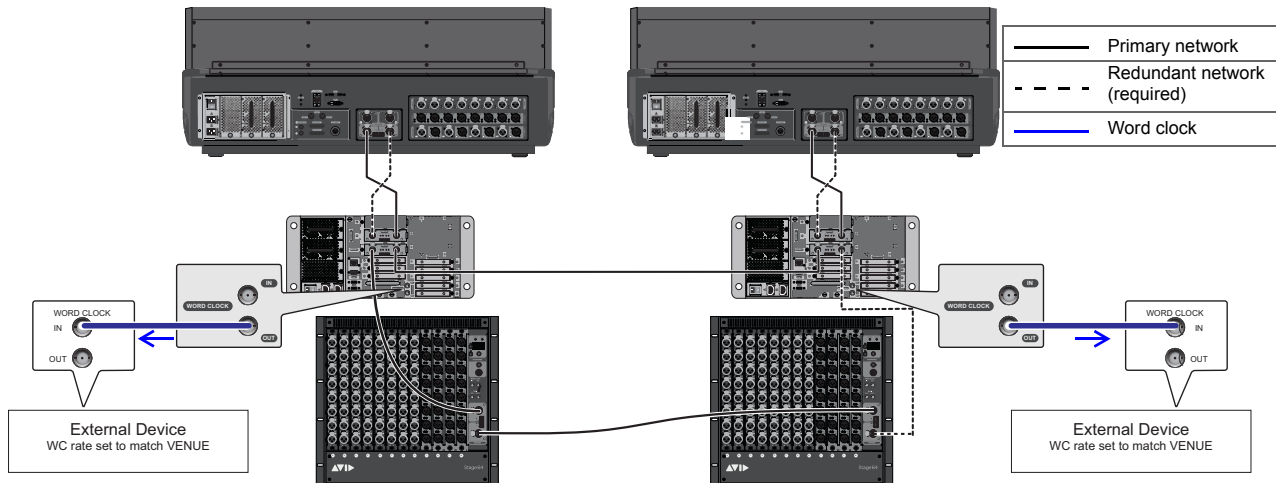

Connecting Word Clock Out from both E6L engines when configured for I/O Sharing

⚠ At the time of this writing, the WC Out port on the MADI-192 MADI Option card (if any) is not supported and should not be used.

Syncing S6L to External Word Clock when Configured for I/O Sharing

To sync S6L to an external device when configured for I/O Sharing:

- Connect a BNC cable from the external device to a **Word Clock In** port on either (one) of the E6L engines on the network. When the E6L to which the external device is connected detects a valid word clock signal, EXT is indicated in its Status box and that E6L is automatically designated as the S6L Media Clock Master. When your S6L system is synced to an external device, the E6L designated as the Media Clock Master cannot be changed.

⚠ Never connect word clock from one engine to the other when sharing I/O, and always make sure that only one E6L engine's word clock input is connected if using an external word clock when sharing I/O.

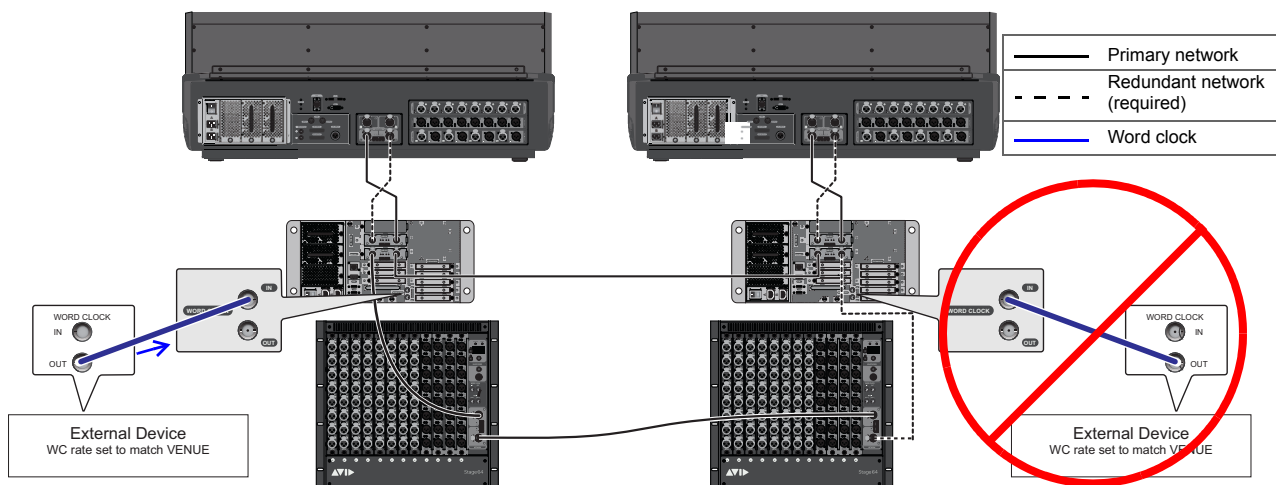

Connecting word clock output from an external device to an E6L Word Clock In (connect to either single engine, but never both)

⚠ At the time of this writing, the Word Clock In port on the Stage 64 is not supported and should not be used.

Using a Distributed External Master Clock to Synchronize Multiple Devices

When routing MADI or AES/ADAT audio between VENUE system(s) and multiple external devices, use a distributed external master clock to provide a common word clock to each device.

In a distributed master clock configuration, a dedicated word clock connection is made from a master clock source (such as a clock generator) to the VENUE system, and separate dedicated word clock connections are made from the master clock source to each external device. All external devices must be set to a 96 kHz word clock rate.

You might have to configure the external devices to receive word clock. Check the device's documentation.

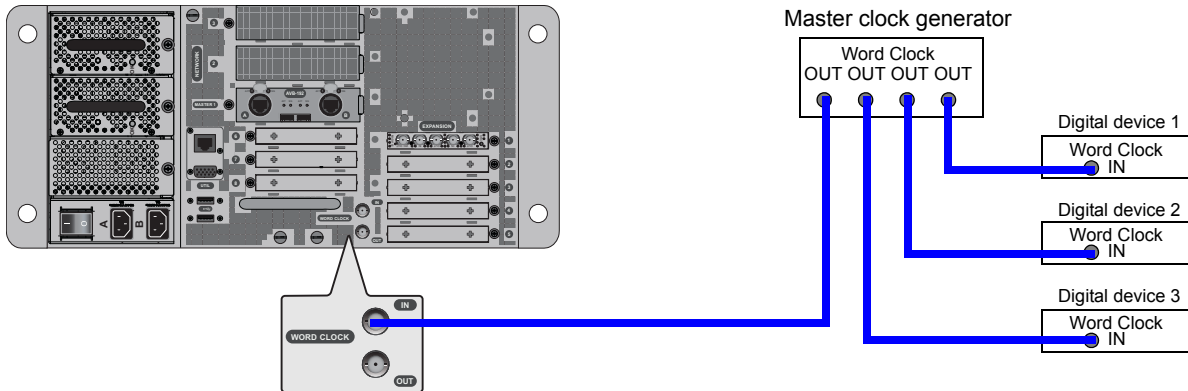

Distributed word clock

Synchronizing using AES/ADAT or MADI Clock

S6L AES/ADAT and MADI outputs can be used as the clock source for compatible external devices (the external device must support syncing to these types of signals).

Synchronizing AES/ADAT Digital Audio Inputs (SRC)

The AES digital inputs on the S6L control surface and the DSI-192 card provide sample rate conversion on input, letting you connect a wide variety of digital sources without having to be concerned with synchronization and clock connections. Sample rate conversion does, however, induce processing delay to the incoming digital signal. (If the source device and S6L are already synchronized via word clock then you can defeat SRC to minimize latency.)

Sample Rate Conversion Latency

The following table illustrates the sample rate conversion processing delay at various sample rates.

External Sample Rate	SRC Process Delay
32 kHz	1.50 ms
44.1 kHz	1.09 ms
48 kHz	1.00 ms
88.2 kHz	0.848 ms
96 kHz	0.833 ms

Working with DSI-192 Digital Inputs

On systems that include a DSI-192 card, you can manually disable the SRC on AES input pairs, and you can designate the ADAT optical port on the card as the active input source on the card on the external screen.

Defeating SRC on a DSI-192 Inputs

You can manually disable SRC on each DSI-192 AES input, or on all ADAT inputs to ensure the lowest possible latency.

To disabled SRC on a DSI-192 AES channel pair:

- 1 On the external screen, go to the Inputs page.
- 2 Attention the channel whose source is the DSI-192 input for which you want to defeat SRC.
- 3 Select the SRC OFF button in the Input section so it lights (the same LED on the DSI card lights to indicate SRC is disabled).



SRC OFF button

Enabling ADAT Inputs

You can designate the ADAT optical port as the active input source on the card. When ADAT inputs are enabled, AES inputs are not operative. When SRC is enabled, at 48 kHz the ADAT inputs can receive eight channels of audio, 4 channels at 96 kHz, and two channels at 192 kHz.

To enable ADAT inputs:

- 1 On the external screen, go to the Devices page.
- 2 Put the system into Config mode.
- 3 In the Connected Devices column, select the Stage 64 in which the DSI-192 card is installed so it is highlighted in blue.
- 4 In the Information section, select the Settings tab.
- 5 Next to the DSI card, select the AES/ADAT pop-up menu, and choose one of the following options to enable ADAT inputs:
 - ADAT 48K 8 ch
 - ADAT 96K 4 ch
 - ADAT 192k 2 ch

The ADAT source LED lights on the DSI-192 card. When the DSI-192 detects a valid ADAT signal, the **Lock** LED lights on the DSI-192 card.

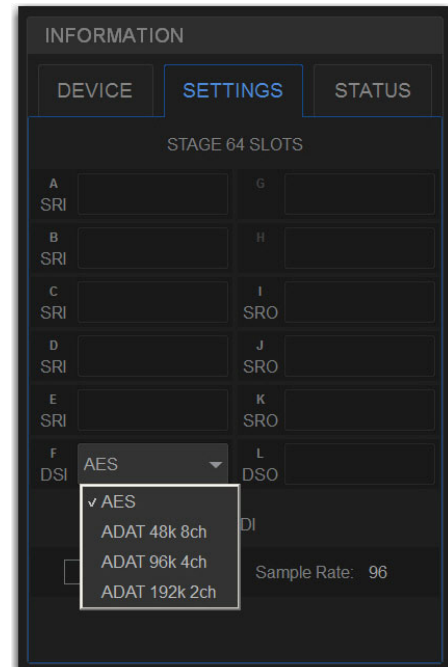

DSI-192 card AES/ADAT pop-up menu

Synchronizing MADI Devices

Whenever two MADI devices are connected together, care must be taken to ensure they are properly synchronized or the audio will suffer from clicks, pops and distortion (even if the devices are operating at the same sample rate).

- In simple configurations where you are clocking a single external device with a single S6L system, the device providing source audio (whether S6L or the external device) can serve as the master word clock source.
- When two S6L systems are exchanging MADI, special word clock requirements apply.
- When sending MADI from S6L to an external MADI device, synchronization can also be achieved by configuring that external device to clock to the incoming MADI signal.
- In configurations where more than two digital devices are being connected, *distributed* word clock should always be used. In these types of more complex configurations, use dedicated, “distributed” word clock connections from the master (or “house”) clock source to each device. For more information, see [Using a Distributed External Master Clock to Synchronize Multiple Devices](#).

⚠ Do not “daisy-chain” word clock among multiple devices. Use a distributed word clock configuration.

This section shows the following example configurations:

- [Using Word Clock to Synchronize Two VENUE Systems Exchanging MADI \(Non-I/O Sharing\)](#)
- [Synchronizing Two VENUE Systems Exchanging MADI in I/O Sharing Configurations](#)
- [Using MADI Audio to Synchronize a Single External MADI Device to S6L](#)

Not all devices support all of these synchronization methods, so you should consult the user guide for your MADI device in order to determine its capabilities.

Using Word Clock to Synchronize Two VENUE Systems Exchanging MADI (Non-I/O Sharing)

When using MADI to or from two VENUE S6L systems that are *not* configured for I/O Sharing, one of the systems must provide word clock to the other system. Once connected, the S6L system receiving word clock detects it automatically.

Do not attempt to sync an S6L system to incoming MADI from another S6L system; use word clock instead.

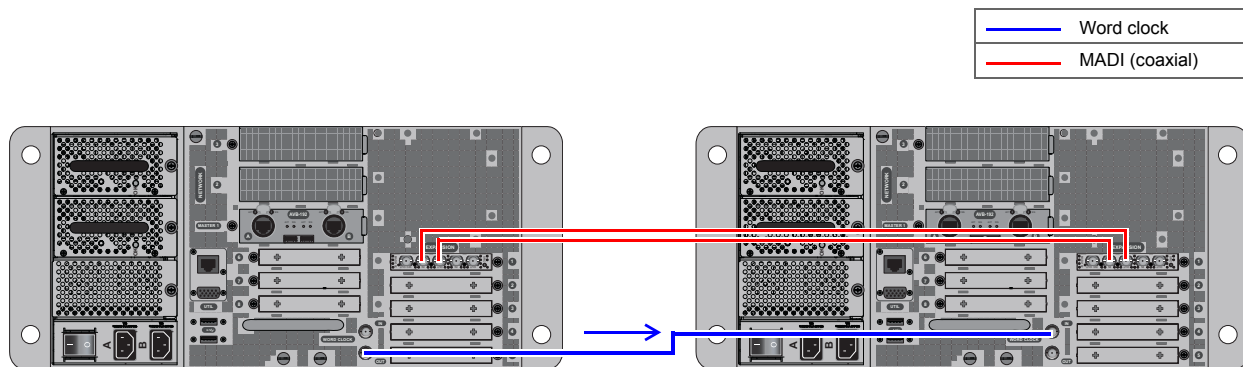

Connecting Word Clock between two independent (not I/O Sharing) VENUE S6L systems exchanging MADI via MADI-192 MADI Option Cards (E6L 1 Word Clock Out, at left, to E6L 2 Word Clock In, at right)

To synchronize two discrete (non-I/O Sharing) VENUE systems:

- Connect the coaxial cable from the **WORD CLOCK OUT** port on one of the VENUE S6L systems to the **WORD CLOCK IN** port on the other VENUE system.

The VENUE system receiving word clock auto-detects word clock and displays EXT in the Mode box on-screen.

⚠ Never connect word clock from one engine to the other when they are connected for I/O Sharing. If using an external word clock to distribute master clock, always make sure that only one E6L engine's word clock input is connected to that external, distributed word clock source. For more information, see [Important: Synchronization in Shared I/O Configurations](#).

Synchronizing Two VENUE S6L Systems Exchanging MADI in I/O Sharing Configurations

If MADI is being exchanged between two VENUE S6L Systems in an I/O Sharing configuration, there must be no word clock connection between engines (Internal sync, as shown in the figure below).

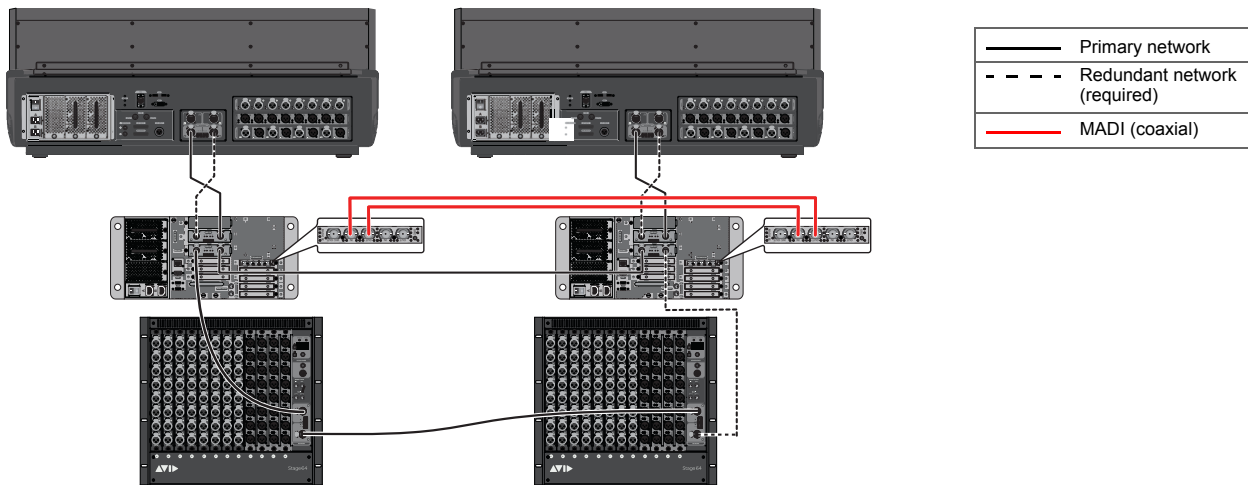

Connecting MADI audio between two VENUE S6L systems configured for I/O Sharing, with no external word clock

If you are also connecting external digital devices, there should be a single external word clock connection from a distributed master word clock source (recommended) or from a single external device to *one* E6L Word Clock input only.

⚠ *Never connect word clock from one engine to the other when sharing I/O, and always make sure that only one E6L engine's word clock input is connected if using an external word clock when sharing I/O.*

Using Word Clock to Synchronize a VENUE S6L System and Another MADI Device

When using MADI to connect your VENUE S6L system to a single external MADI device such as a digital mixing console, the VENUE system can receive or provide word clock.

To synchronize a VENUE S6L system to a single external MADI device using word clock:

- Connect a coaxial cable from the word clock out of the external MADI device to the **WORD CLOCK IN** port on your E6L engine.

The external MADI device must be set to send 96 kHz word clock rate to your VENUE S6L system. The VENUE system auto-detects external word clock and displays EXT in the Mode box on-screen. For an example diagram, see [Syncing an S6L System to an External Device using Word Clock](#).

To synchronize a single external MADI device to a VENUE S6L system using word clock:

- Connect a coaxial cable from the **WORD CLOCK OUT** port on your E6L engine to the word clock in port on your external MADI device. For an example diagram, see [Syncing External Devices to an S6L System using Word Clock](#).

The external MADI device may need to be configured to receive the 96 kHz word clock rate provided by the VENUE S6L system. Check the device's documentation.

⚠ *At the time of this writing, the **WC Out** port on the MADI-192 MADI Option Card is not supported and should not be used.*

Using MADI Audio to Synchronize a Single External MADI Device to S6L

If your external device supports it, you can use the MADI signal from Stage 64, Stage 32, or MADI-192 MADI Option cards (if any) to provide clock to your external MADI device. The device must be configured to sync to the incoming MADI signal. Refer to the documentation for the device.

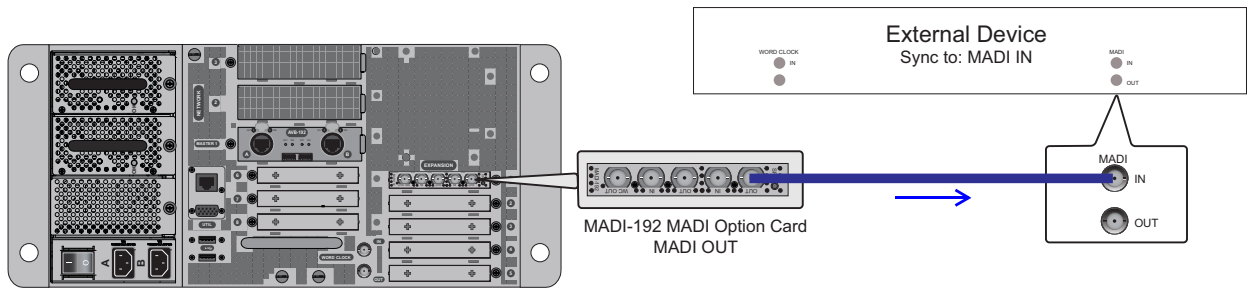

External device connected and configured to sync to incoming MADI, supplied by MADI-192 MADI Option card MADI OUT

If your S6L systems are configured for I/O sharing, be sure to read and follow the guidelines in [Important: Synchronization in Shared I/O Configurations](#).

⚠ *Only use high-quality BNC cables when attempting to use MADI sync. Lesser quality cables are susceptible to drop outs and loss of sync.*

For additional information about MADI for recording, playback, and Virtual Soundcheck, see the *VENUE S6L Live Recording Guide.pdf*.

Time Code

S6L provides a set of synchronization features that allow automation and remote control of snapshot and triggering of external devices when snapshots are recalled via SMPTE MIDI Time Code (MTC) or Linear Time Code (LTC).

Automating Recall of Snapshots with Time Code

You can automate the recall of snapshots with MTC and LTC. The VENUE system can trigger snapshots with internally generated MTC, or it can read incoming MTC or LTC from an external source.

 For a diagram showing LTC and MTC ports, see [S6L Control Surface Connections](#).

Generating MIDI Time Code

You can set the VENUE system to generate MTC and automate the recall of snapshots based on MTC playback.

To generate MTC from the VENUE system:

- 1 On the external VENUE software screen, go to Options > Snapshots.
- 2 Enable Config mode.
- 3 Under Time Code, select MTC.

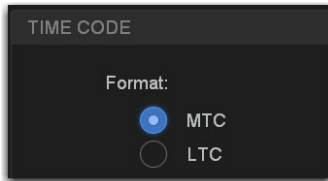

MTC selected as the Time Code Format

- 4 Select Generate. MTC generator (MTC GEN) controls appear in the banner display at the bottom of the screen.



MIDI Time Code set to Generate (left) and the MTC generator controls (right)

- 5 Choose the MTC Frame Rate from the Frame Rate pop-up menu (24 fps, 25 fps, 30 fps drop, or 30 fps non-drop).
- 6 If you want MTC playback to start at a different time than the currently displayed time, enter a start time in the Start Time field, and press Enter.

The custom start time is stored in the Show file.

 *Performing a Clear Console resets the start time to the default of 01:00:00:00.*

- 7 Control MTC playback from the MTC generator controls by doing any of the following:
 - Start MTC playback by selecting the Play button.
 - Pause MTC playback by selecting the Pause button.
 - Stop MTC playback and reset to the Start Time by selecting the Stop button.

Configuring S6L to Slave (Chase) External Time Code

The VENUE system can slave to external MTC or LTC and automate the recall of snapshots based on the incoming time code. Incoming time code can also be used as a Trigger in **Events**. VENUE automatically detects the frame rate of the incoming time code when enabled. The following frame rates are supported: 24 fps, 25 fps, 30 fps drop, or 30 fps non-drop.

To configure S6L to slave to external time code:

- 1 On the external software screen, go to Options > Snapshots.
- 2 Do one of the following:
 - To chase to incoming MTC, under Time Code Format, select MTC.
 - To chase to incoming LTC, under Time Code Format, select LTC
- 3 Select Read. A time code display appears at the bottom of the screen.

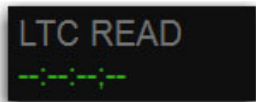

Time Code display (drop frame LTC shown)

The time code display indicates the following:

- When external time code is not present, the display shows a series of dashes.
- When external time code is present, the current time code value is shown in green.
- When time code is non-drop frame, HMSF separators are colons; when drop frame, HMSF separators are semicolons.

Snapshot Time Code Display

When the system is set to generate or read time code, the Snapshots list shows time code values and a green Recall Enable indicator for each snapshot entry.



Snapshots list showing time code values and indicators

Assigning Time Code Values to Snapshots

With the S6L system set to generate or read time code, you can assign time code values to snapshots by entering values manually, or by capturing time code playback values.

Manually Assigning Time Code Values to Snapshots

To manually assign an time code value to a snapshot:

- 1 In the Snapshots list, double tap the time code value you want to change.
- 2 Do one of the following:
 - From the keyboard, type a new value.
 - or –
 - Press the Left and Right Arrow keys to move the cursor between number fields, and the Up and Down Arrow keys to increase and decrease the selected value.
- 3 Press Enter or select another snapshot time code value to accept the entry.

Capturing Time Code Values in Snapshots

To capture the current time code value in a new snapshot:

- 1 With the system in Read or Generate mode, start time code playback.
- 2 Do one of the following:
 - During playback, select the New button.
 - or –
 - Pause playback at the time code value you want to capture, and select the New button.

A new snapshot appears with the time code value at the time of creation.

To capture the current time code value in an existing snapshot:

- Tap-and-hold (right click) the snapshot in the Snapshots list and choose Set Time Code To from the menu.

The time code value is updated to the currently displayed value.

Sorting Snapshots by Time Code Value

You can sort snapshots in the Snapshots list by time code value, so that they appear in chronological order.



When chasing to MTC, snapshots will always recall in chronological order, regardless of their order in the Snapshots list.

To sort snapshots by their assigned Time Code value:

- Tap-and-hold (right click) any snapshot in the Snapshots list and choose Re-Sort All By Time Code from the menu.

Enabling Snapshots for Automated Recall

With time code values assigned to snapshots, you can then enable individual snapshots for recall with time code playback.

To enable snapshots for automated recall with time code:

- Select the Time Code Recall Enable indicator on the right side of the Snapshots list. The indicator turns bright green to indicate that the snapshot is enabled for recall.



Make sure the Start Time (Options > Snapshots) is earlier than the beginning of incoming time code.

Snapshot Chase to Time Code

With snapshots enabled for automated recall, the Chase function needs to be engaged to allow automated recall to occur. When MTC is selected the button appears as Chase MTC. When LTC is selected, the button appears as Chase LTC.

To initiate automated recall of snapshots:

- 1 Make sure you have followed the instructions in [Configuring S6L to Slave \(Chase\) External Time Code](#).
- 2 Select the Chase MTC/LTC button so that it is highlighted.
- 3 Begin time code playback by starting the internal generator (if set to MTC Generate) or the external device (if set to Read).

When a recall-enabled snapshot's time code value is reached, the snapshot is recalled.



Snapshot modes can affect MTC recall. For more information, see [MTC/LTC and Other Online Event Triggers](#).

The Chase MT/LTC button can be used to quickly take VENUE system offline from time code-triggered recall in performance in the event of a change in timing, such as a missed cue or dropped verse. You can then advance manually to an appropriate snapshot, and re-enable Chase MTC.



VENUE systems do not chase up to the current time code value. If you start playback in the middle of a snapshot sequence, any prior snapshots will need to be recalled manually to update the system before beginning time code playback. For more information, see [Recalling Snapshots](#).

Remote Control of Snapshot Recall

The VENUE system can be set to recall snapshots in response to MIDI control messages sent from an external device such as an AV controller system. You can set the system to respond to control messages sent on any one of 16 available MIDI channels.

The following information describes legacy snapshot recall via MIDI Bank Select and Program Change messages, which can recall Parent or unaffiliated snapshots but not Child or Momentary snapshots. You can instead use MIDI Input to trigger recall of any snapshot using [Events](#).

Using MIDI Bank Select and Program Change to Recall Snapshots

Snapshots are recalled when their snapshot number (1–999) is received in the form of MIDI Bank Select and Program Change messages. (See [Table 7 on page 365](#).)

To enable recall of snapshots from an external device:

- 1 On the external software screen, go to Options > Snapshots.
- 2 Under MIDI, select the Snapshots Respond to Channel option, and choose the MIDI channel from the corresponding pop-up menu.

The system listens on the specified channel for Bank Select and Program Change messages.



 *The MIDI Snapshot Output Safe option (Options > Snapshots page) does not affect this option. You can only turn off this feature by de-selecting the “Snapshots Respond to Channel” option.*

Table 7. MIDI Bank and Program Numbers for Snapshots

Bank	Program	Snapshot Number
0	0–127	001–128
1	0–127	129–256
2	0–127	257–384
3	0–127	385–512
4	0–127	513–640
5	0–127	641–768
6	0–127	769–896
7	0–103	897–999

 *VENUE software stores Bank Select messages, so it is not necessary to send a Bank Select message prior to every Program Change message. You only need to send a Bank Select message when you want to recall a snapshot in a different bank from the previous snapshot.*

Triggering of External Devices on Snapshot Recall

The VENUE system can be set to send MIDI Bank and Program Change messages whenever a snapshot is recalled, to trigger external devices whose cues are related to snapshots. You can set the system to send on any one of 16 available MIDI channels.

 *MIDI output is automatically suspended while in Preview mode. For more information, see [Preview Mode](#).*

While it is possible to add Bank Select and Program Change messages to individual snapshots, this option lets you toggle messages on and off for all snapshots in one step. Using this option also ensures that the Bank Select and Program Change messages correspond to the snapshot number, even after snapshots are rearranged in the Snapshots list.

 *You can also use [Events](#) to trigger MIDI output.*

The Bank Select and Program Changes messages reflect the number (1–999) of the recalled snapshot. (See [Table 7 on page 365](#).)

 *VENUE systems always send a Bank Select message before every Program Change message, even if the bank number has not changed from the previous snapshot.*

To enable triggering of external devices when snapshots are recalled:

- 1 On the external software screen, go to Options > Snapshots.
- 2 Under MIDI, select the Snapshots Send on Channel option, and choose the MIDI channel from the corresponding pop-up menu.

The VENUE system sends a Bank Select and Program Change message on the specified channel whenever a snapshot is recalled.

 *The MIDI Snapshot Global Safe option (in the Recall Safe tab of the Snapshots page) does not affect this option. You can only turn off this feature by de-selecting the “Snapshots Send on Channel” option.*

Sending MIDI Messages on Snapshot Recall

You can add up to 20 specific MIDI messages to each snapshot. These messages are sent whenever the snapshot is recalled. Sending of the messages is enabled with the MIDI scope control in the Snapshots window. For more information, see [Adding MIDI and Plug-In Data to Snapshots](#).

Connecting and Using the MADI-192 MADI Option Card

If you have installed one or more MADI-192 MADI Option Cards in your E6L engine you can make audio connections between your VENUE system and your MADI device.

You must establish proper synchronization between your VENUE system and any connected MADI devices. You may or may not need to make additional connections. See [Synchronizing MADI Devices](#).

In VENUE Standalone software version 5.3 or higher, you can add MADI cards to the configuration in the EXPANSION CARDS section of the Options > Devices page. You can then view MADI Device information and settings, but you cannot change settings.

Making Audio Connections

This section shows how to make the audio connections between your VENUE S6L system and your MADI device.

(For installation instructions, see the *MADI-192 Card Installation* guide, included with the card and available for download from your Avid account.)

Sending Audio

The MADI-192 MADI Option Card provides two coaxial outputs. Both coaxial outputs of the MADI card are active at all times.

To connect a MADI device to your VENUE system:

- 1 Power up your VENUE system.
- 2 Connect to your MADI device using the coaxial MADI Output connectors of the MADI card.

Receiving Audio

When your VENUE system is receiving audio from a MADI device, both coaxial inputs on the MADI-192 MADI Option Card are available at all times.

To connect a MADI device to your VENUE system:

- 1 Power up your VENUE system.
- 2 Connect to your MADI device using the coaxial MADI Input connectors of the MADI card.

 *S6L systems cannot clock directly to incoming MADI audio. You must establish proper synchronization between your VENUE system and any connected MADI devices. See [Synchronizing MADI Devices](#).*

Using MADI

You can use the MADI-192 MADI Option card with your VENUE S6L system in the following ways:

Assignable Mode

In this mode, all signal paths of the MADI-192 card are available in the VENUE Patchbay, and can be patched freely. The MADI card can also be used for Hardware Inserts via MADI.

Pro Tools Input Mode

In this mode, Pro Tools is the main source of audio signals for VENUE and can be used in either Input or Virtual Soundcheck mode. Either mode can be configured to receive audio via AVB, or via MADI.

Input Mode In this mode, audio from your AVB or MADI device is the main audio source for your VENUE system. Stage inputs on your VENUE system are replaced with inputs from Pro Tools via AVB or MADI, or from an external MADI device such as another VENUE system or another digital mixing console. Input channel gain and other PRE parameters such as HPFs can be stored in Snapshots.

Virtual Soundcheck Mode In this mode, pre-recorded audio from Pro Tools via AVB or via an external MADI device is the main source of audio for VENUE. Stage inputs on your VENUE system are replaced with inputs from your external MADI device. Changes made in Virtual Soundcheck mode, including Snapshot creation and modification, carry over when switching back to Stage mode. Input channel gain changes made while in Virtual Soundcheck mode can be applied to Stage input channels when switching back to Stage mode. On systems with three or more MADI Option cards, only MADI-192 MADI Option Cards installed in slots 1 and 2 are available for Virtual Soundcheck.

Redundant Outputs

You can install multiple MADI cards and operate them in a redundant output configuration. For redundant recording, you can also enable both AVB and MADI as Virtual Soundcheck Destinations.

Assignable I/O

For any system input channels that have Stage inputs assigned as their sources, assignable recording outputs are available, up to the maximum number of available Pro Tools I/O channels. Assignable outputs can be used to send the Main L/R mix, submixes from sources such as Matrix and Groups, the Direct Outs of S6L system I/O channels, and audience mics to Pro Tools.

For any system input channels not assigned Stage inputs as their sources, assignable Pro Tools inputs are available, up to the maximum number of available Pro Tools I/O channels. Assignable inputs can be used to monitor your Pro Tools recording on your S6L system, or to incorporate pre-recorded audio tracks into your live mix.

 *For more information about gain, snapshots, and other aspects of Virtual Soundcheck, see the S6L Live Recording Guide.pdf.*

Hardware Inserts

Any MADI IO on MADI Option cards in slots 1 and 2 become unavailable as hardware inserts while MADI is selected as a Virtual Soundcheck Source or Destination.

Enabling Virtual Soundcheck Recording

 For complete instructions on setting up and using Virtual Soundcheck, see the *S6L Live Recording Guide.pdf*.

You can enable direct digital splits by configuring the System Outputs setting in Options > System. By default AVB is the designated system output destination. You can change this to MAD1, or BOTH, to designate the MAD1 card as a Virtual Soundcheck destination. The Pro Tools tab of the VENUE Patchbay feeds the cards. Up to two MAD1 cards can be used for Virtual Soundcheck.

The pickoff point for each Stage input split is post-analog input gain, but pre-digital trim and channel processing, including the channel HPF. Thus, the gain for any input channel sent to Pro Tools is dependent on the S6L system input gain setting for that Stage input channel.

Recordings of direct digital splits form the basis of the Virtual Soundcheck workflow, and are also useful for capturing unprocessed audio files of your Stage inputs for later mixdown and editing.

To enable Stage inputs:

- 1 Make sure the Stage inputs you are using are patched to the desired S6L system input channels in the Patchbay.
- 2 Put your S6L system into Config mode.
- 3 On the external VENUE software screen, go to the Options > System tab.
- 4 In the System Inputs section, make sure **Stage** is selected. If Stage is not selected, do the following:
 - Select **Edit**.
 - Select **Stage**.
 - Select **Apply**.

Signals from any Stage inputs assigned to S6L system input channels are sent to the connected Pro Tools computer as direct digital splits. The corresponding channels under the Pro Tools tab in the Patchbay are highlighted in purple to indicate they are in use as digital split outputs and as Virtual Soundcheck inputs.

To configure Virtual Soundcheck Outputs:

- 1 Put your S6L system into Config mode.
- 2 On the external VENUE software screen, go to the Options > System tab.
- 3 Select **Edit**.
- 4 In the System Outputs section, choose one of the following from the Virtual Soundcheck Destination selector:

AVB Splits are sent to Pro Tools via AVB.

MAD1 Splits are sent to Pro Tools via the outputs on the MAD1 card.

Both Splits are sent through both AVB and MAD1.

- 5 Select **Apply** to apply your settings.

 If you want to use VENUE Link for enhanced Virtual Soundcheck, it requires a dedicated Ethernet connection from port **C** on the S6L control surface to the Pro Tools computer. For more information, see the *S6L Live Recording Guide.pdf*

Performing a Virtual Soundcheck using MADI-192

In Virtual Soundcheck mode, audio from your external MADI devices can replace the corresponding Stage inputs one-for-one, and appear in place of those Stage Inputs in the VENUE software Patchbay. All changes (such as channel assignments, and input and output processing) are carried over when you switch to Virtual Soundcheck mode, and the digital portion of the gain for each channel is preserved and applied to the incoming MADI signal. This results in the same apparent levels for both the MADI inputs and the Stage inputs.

To perform a Virtual Soundcheck using MADI:

- 1 Do one of the following to put your system into Config Mode:
 - Press the **Config** switch on the console.
 - Double-click the Mode box in the bottom-right corner of the screen.
- 2 Go to the Options > System tab to access the System Configuration page.
- 3 Click Edit.
- 4 In the System Inputs section of the System Configuration page, click to enable Pro Tools.
- 5 Choose Virtual Soundcheck MADI from the Pro Tools selector.

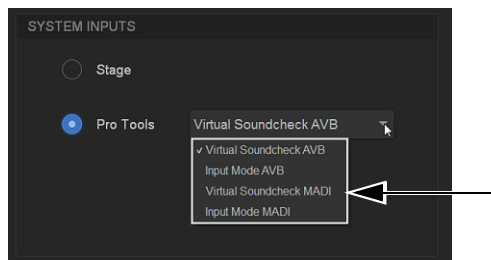

Virtual Soundcheck MADI option in the Pro Tools sector (Options > System)

- 6 Click Apply.

All S6L system input channels with Stage inputs assigned to them are replaced with their corresponding Virtual Soundcheck inputs from Pro Tools. Pro Tools icons appear in the Patchbay > Inputs tab patching grid for all assigned Stage inputs, indicating that input sources for the affected input channels are now Virtual Soundcheck inputs from Pro Tools. Any MADI IO designated as hardware inserts become unavailable as inserts (their patch assignments are retained).

If you change input routing when MADI inputs are active, those changes remain when you switch back to Stage input mode.

Enabling Redundant Outputs

For redundant recording, you can enable both AVB and MADI as Virtual Soundcheck Destinations.

To enable redundant outputs:

- 1 Put your S6L system into Config mode.
- 2 On the external VENUE software screen, go to the Options > System tab.
- 3 Select Edit.
- 4 In the System Outputs section, choose Both from the Virtual Soundcheck Destination selector:

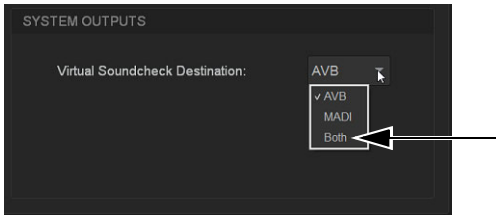

Enabling redundant outputs (Both) for the Virtual Soundcheck Destination (Options > System)

- 5 Select Apply to apply your settings.

Using MADI for Hardware Inserts

MADI IO can be used as hardware inserts, just like other supported system IO. Hardware inserts can be used for external processing on individual input channels, Mains, Groups, Auxes, and Matrixes. To use external hardware as inserts, you must do the following:

- Connect external hardware
- Assign hardware inserts to channels
- Activate the insert
- Set the hardware insert location

For instructions, see [Hardware Inserts](#), and be sure to note the following about MADI availability with Virtual Soundcheck mode:

- Whenever a MADI card is enabled as a Virtual Soundcheck destination, its IO becomes unavailable for use as hardware inserts. Assignments are retained (but disabled) when Virtual Soundcheck mode is enabled, and are restored when exiting Virtual Soundcheck mode.

Hardware Inserts

This chapter explains how you can connect external analog and digital hardware to the analog and digital I/O on the S6L control surface, Stage I/O units, Local 16, or E6L engine (if any MADI-192 MADI Option cards are installed) for use as hardware inserts. Hardware inserts can be used for external processing on individual input channels, Mains, Groups, Auxes, and Matrixes. To use external hardware as inserts, you must do the following:

- Connect external hardware
- Assign hardware inserts to channels
- Activate the insert
- Set the hardware insert location

 *The S6L-16C control surface does not support IO connections for hardware inserts. Use Local 16 or Stage I/O instead.*

Connecting External Hardware

External hardware is made available to the system by connecting its inputs and outputs to input and output connectors on the S6L control surface (all except S6L-16C), Stage/Local I/O unit, or E6L engine (if any MADI-192 MADI Option cards are installed). Hardware inserts can then be inserted on channels similarly to inserting plug-ins.

To connect outboard gear for use as a hardware insert:

- 1 Connect the inputs of the external device to analog and/or digital output connectors 1–8 on the S6L control surface or Local 16.
- 2 Connect the outputs of the external device to the corresponding input connectors on the S6L control surface or Local 16.
For example, signal taken from S6L control surface AES Digital outputs 1/2 must be returned to S6L control surface AES Digital input 1/2.

 *Digital inputs on the S6L control surface and on the DSI-192 card offer sample rate conversion. For more information, see [Synchronizing AES/ADAT Digital Audio Inputs \(SRC\)](#).*

Using MADI-192 MADI Option Card IO for Hardware Inserts

If your system includes one or more MADI-192 MADI Option cards, you can use its inputs and outputs for hardware inserts from/to the E6L engine. For details on configuring and using MADI Option card inserts, see the [Using MADI for Hardware Inserts](#).

Assigning Hardware Inserts to Channels

You can assign hardware inserts directly from the Inputs or Outputs page, or from the Patchbay.

 *Input and output levels to and from devices assigned as hardware inserts are automatically set to 0 dB, and cannot be changed in VENUE. Set trims on the device itself.*

To assign a hardware insert to a channel or bus:

- 1 On the external VENUE software screen, go to the Inputs or the Outputs page and attention the channel on which you want to insert the external device.
- 2 In the Inserts section, do one of the following:
 - Select the Hardware Insert pop-up menu and choose an insert destination directly from the menu. The name of the hardware insert destination appears in the on-screen Hardware Insert button.
 - or –
 - Select the Hardware Insert button to “jump” to the Inserts tab of the Patchbay, and assign the insert from the Patchbay.



Hardware Insert pop-up (left), Hardware Insert button to jump to the Inserts tab (right)

To assign a hardware insert from the Patchbay:

- 1 On the external software screen, go to the Patchbay page and select the Inserts tab. The Console hardware tab is shown.
- 2 Click a tab along the left side of the grid to show the desired channel types in the grid. If you jumped to the Patchbay from the Inputs or Outputs page, the appropriate Channel Type tabs are automatically selected.
- 3 Touch in the channel grid to assign the hardware insert input/output (listed across the top) to the channel where you want to assign the insert (listed on the left).

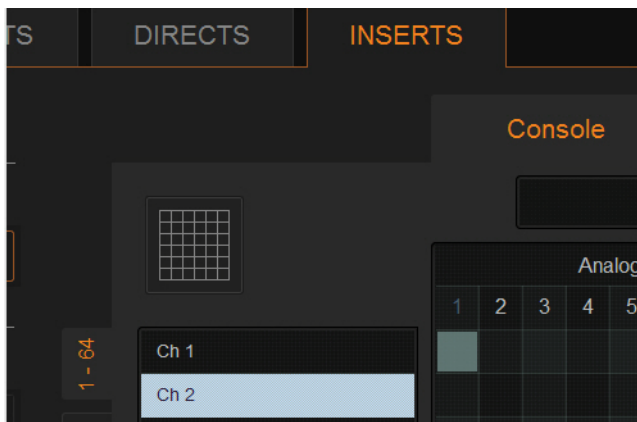

Assigning a hardware insert on the Inserts tab of the Patchbay I

The Insert location is also displayed in the Hardware Insert pop-up in the Inserts section of the Inputs or Outputs page for the attentioned channel.

Reassigning Hardware Inserts

If a hardware input is currently assigned to an input channel and then reassigned as a hardware insert, the gain on that input is automatically set to 0 dB. When reassigning a hardware input from an insert to an input channel, the gain setting for that channel is automatically set to +10 dB.

Activating and Bypassing Hardware Inserts

You can toggle hardware inserts in/out on-screen, and from the control surface using Events.

⚠ *Before activating a hardware insert, be sure that you have connected the external unit to your S6L system. If you activate the hardware insert and audio on that channel is not present, double-check your cabling to make sure it is connected correctly.*

To activate or bypass a hardware insert on-screen.

- 1 Go to the Inputs or Outputs page and select the channel where you want to activate or bypass the insert.
- 2 Click the In/Out button for the HW insert. The button lights when the insert is activated (in circuit).

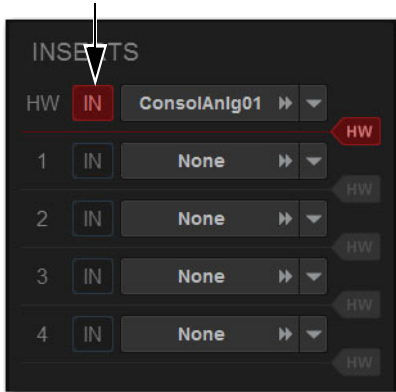

Activating a hardware insert

💡 *Any HW inserts on MADI-192 cards are unavailable when VSC MADI is enabled. For details on configuring MADI Option card inserts, see the [Using MADI for Hardware Inserts](#).*

You can also define an Event to toggle a hardware insert in/out via a Function or other hardware switch, a fader or other continuous control, MIDI input, or a system value. For instructions on how to create and define Events, see [Events](#).

Setting the Hardware Insert Location

You can choose the location of the hardware insert in the signal path relative to the four plug-in inserts on a per-channel basis.

To set the hardware insert location:

- 1 Go to the Inputs or Outputs page and select the channel where you want to set the hardware insert location.
- 2 In the Inserts section, select the hardware insert indicator in one of the five available locations so that it lights red.

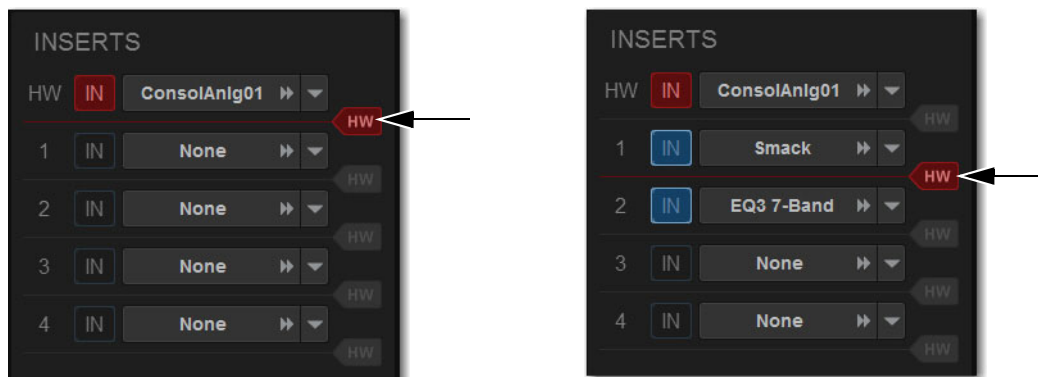

Hardware insert indicator showing the hardware insert before the first plug-in (left), and after the first plug-in (right)

GPI Port Reference

GPI Input Specifications

A 25-pin, male D-Sub connector provides a total of 8 General Purpose Interface (GPI) Inputs. GPI inputs have the following characteristics:

- Inputs are logic inputs with pull-ups. They may be driven by logic outputs or contact closure to ground.
- Input signal range is 0 to 5.5V. The inputs are ESD protected.
- Input signaling uses standard 5C CMOS logic levels: 1.5 V or less for a logic low. 3.5 V or greater for a logic high.
- Inputs are compatible with 5V TTL (e.g. 74LS series) and 5V CMOS (e.g. 74HC series)
- Inputs provide an internal 5K ohm pull-up to +5V.
- All Inputs are referenced to the same internal ground, which is connected to AC safety ground.

GPI Input Connector Pin Assignments

GPI Input Connector Pin Assignments (DB25 male)

Pin Number	Function	Comments
1	Input 1	Logic level (TTL, CMOS) input with pullup
2	Input 2	Logic level (TTL, CMOS) input with pullup
3	Input 3	Logic level (TTL, CMOS) input with pullup
4	Input 4	Logic level (TTL, CMOS) input with pullup
5	Input 5	Logic level (TTL, CMOS) input with pullup
6	Input 6	Logic level (TTL, CMOS) input with pullup
7	Input 7	Logic level (TTL, CMOS) input with pullup
8	Input 8	Logic level (TTL, CMOS) input with pullup
14, 15, 16, 17, 18, 19, 20, 21	Ground	All ground pins are connected together internally
9, 10, 11, 12, 13, 22, 23, 24, 25	Reserved	Do not use

Pinout for GPI Input Connector

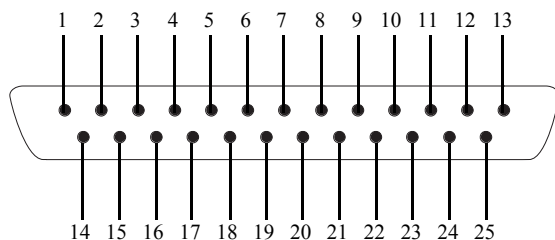

Pinout for S6L DB25M GPI Input port (looking at back of console)

GPI Output Specifications

A 25-pin, female D-Sub connector provides a total of 8 General Purpose Interface (GPI) Outputs.

- Outputs are isolated, floating relay contacts (contact closure).
- Switched voltage is 200V max; 0.5A max.
- Switched voltage with respect to safety/chassis ground is 300V max.

⚠ *GPI Outputs can switch 500 mA maximum. This applies even to short term current surges. This limit can be exceeded when driving a capacitive or incandescent lamp load. An incandescent lamp may draw as much as ten times its steady state current when first turned on. Therefore such lamps are typically not appropriate loads for the GPI Outputs, and should instead be controlled by a secondary relay.*

GPI Output Power Specification

The GPI Output connector also provides +12VDC at up to 200 mA for powering external devices, such as relays or LEDs. The ground return that is provided is the S6L internal system ground, which is connected to AC safety ground.

GPI Output Ground Connections

The GPI Outputs provided are isolated contact-closure style. Each GPI output is presented on a pair of pins. These two pins represent the two sides of a switch that can be opened and closed. If it is desired to drive a signal to ground, then one of the pins must be wired to ground, and the other to the signal to be controlled.

GPI Output Connector Pin Assignments

GPI Output Connector Pin Assignments (DB25 female)

Pin Number	Function	Comments
1, 14	Output 1	Floating contact closure output
2, 15	Output 2	Floating contact closure output
3, 16	Output 3	Floating contact closure output
4, 17	Output 4	Floating contact closure output
5, 18	Output 5	Floating contact closure output
6, 19	Output 6	Floating contact closure output
7, 20	Output 7	Floating contact closure output
8, 21	Output 8	Floating contact closure output
12, 13, 24, 25	+12V auxiliary power	Maximum total load 200 mA All +12V pins are connected together internally
9, 10, 22, 23	Ground for auxiliary power	All ground pins are connected together internally
11	Reserved	Do not use

DB25F Pinout

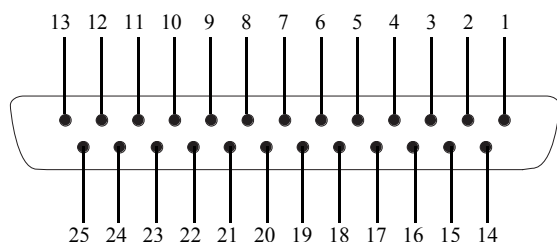

Pinout for S6L DB25F GPI Output port (looking at back of console)

GPI Wiring Diagrams

The following diagrams provide examples of GPI pinout and wiring for the common uses. All diagrams are shown from the rear (solder side) of the DB25 connector.

GPI Input Examples

The following diagrams provide simplified wiring examples for a customer-provided DB25 female connector, to attach to the male GPI In connector on the S6L control surface.

Wiring a Switch to Drive GPI

No ground reference is needed between systems.

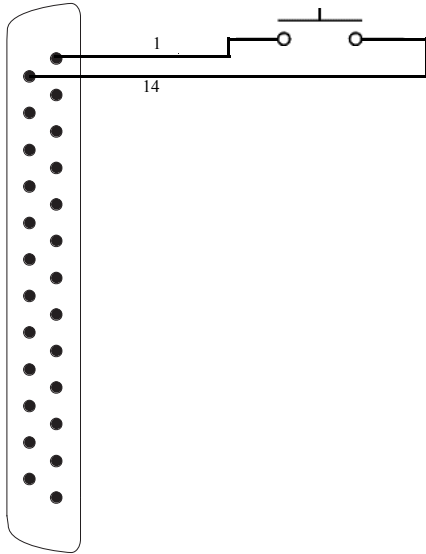

DB25F connector

Wiring a Relay to Drive GPI

No ground reference is needed between systems.

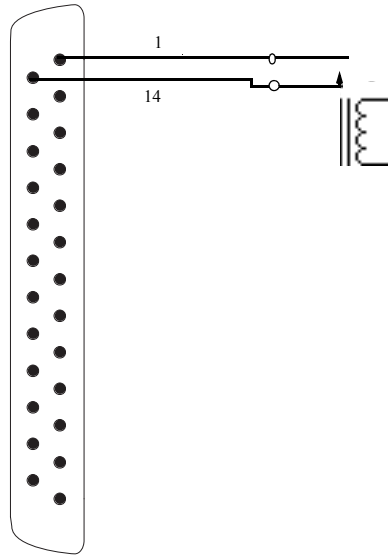

DB25F connector

Wiring a Logic Signal to Drive GPI

Ground reference is required between systems

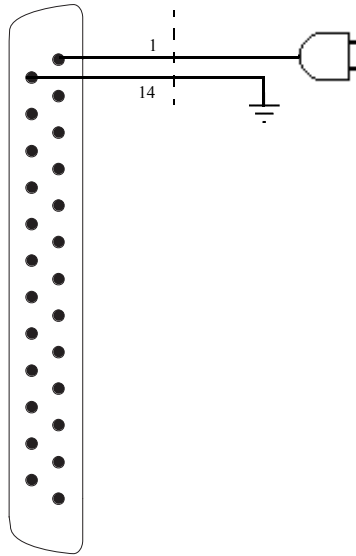

DB25F connector

GPI Output Examples

The following diagrams depict wiring examples for a customer-provided DB25 male connector, to connect to the female GPI Output connector on the S6L control surface.

GPI Output Driving a Relay to Illuminate a Light

No ground reference is needed between systems.

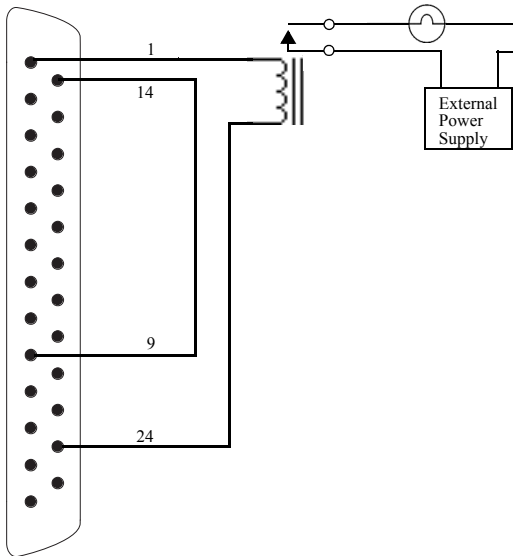

DB25M connector

GPI Output Driving and Powering an LED

Connect one side of the relay to Ground.

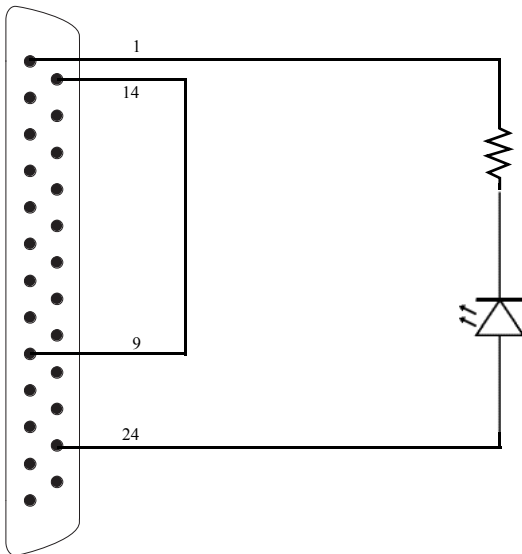

DB25M connector

GPI Output Driving an Externally Powered LED

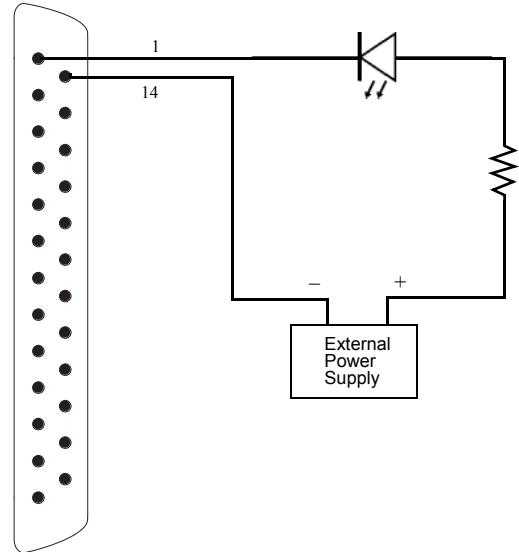

DB25M connector

GPI Output Driving a Logic Input

Ground reference is required between systems.

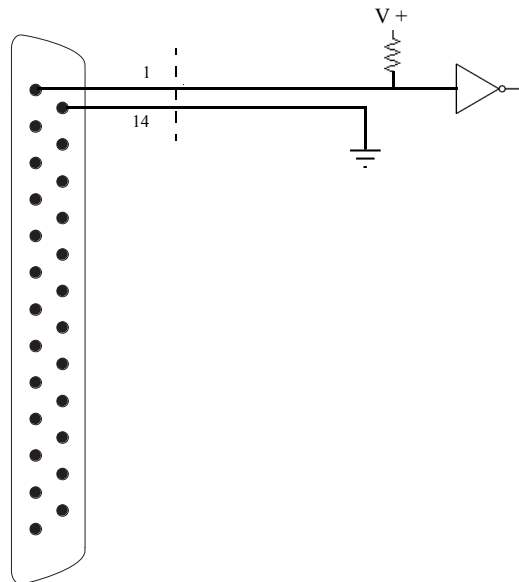

DB25M connector

GPI Output Driving a Relay Using an External Power Supply

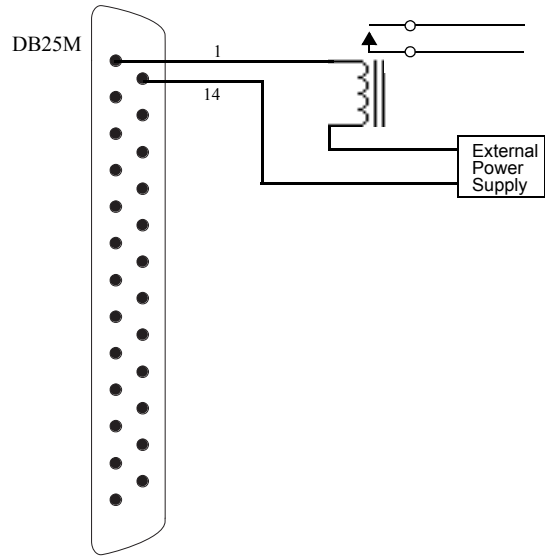

DB25M connector

Troubleshooting

This chapter provides troubleshooting and problem solving information. It includes a table of problems and solutions that provides answers to common questions, explains on-screen text messages, and refers you to specific sections later in this chapter or elsewhere in this guide for details and instructions.

Problem Solving

The following table provides descriptions of situations that may arise while operating a VENUE system and includes common questions, symptoms and error messages, along with possible solutions.

Table 8. Troubleshooting Errors and Messages

Symptom or Message	Possible Cause	Solution
Faders, Switches, Modules, Channels, and Devices		
Fader stuck	Fader path was blocked during startup calibration.	Reset the S6L control surface. See Resetting Hardware Components .
Control surface controls have stopped working	S6L control surface needs to be reset.	Reset the console. See Resetting Hardware Components . If possible, wait for a silent portion of a performance to avoid unexpected gain changes upon reset. For details. If software is frozen, power cycle the system.
	Bad or missing connection to the E6L engine.	Check to make sure the cable connecting the console to the E6L engine is properly connected and not damaged.
Fader Module, Channel Knob Module, Master Live Module has stopped working/lost connection	Network error	See Restarting Your System .
Channel Touch Module (CTM) offline (Please Configure Console message)	Network error	See Resetting Channel Touch Modules (CTMs) .
Stage I/O is not passing audio	Stage unit needs to be reset.	See Resetting Hardware Components . Or, power-cycle the Stage 64
	Bad or missing connection to the E6L engine, to another Stage unit, or to power.	Check to make sure the audio network cable connecting the Stage unit to the E6L engine (or, if daisy-chained, to the nearest Stage unit) is properly connected and not damaged. Check power to the Stage unit.
Cannot assign Stage 64	Config mode is not enabled.	Enable Config mode. See Enabling Config Mode .
S6L control surface I/O is not passing audio	S6L control surface I/O needs to be reset.	See Resetting Hardware Components . Or, power-cycle the control surface.
Touch on external screen is reversed with MTS, or not operating at all	Touchscreens are not configured properly	See Configuring S6L Master Touch Screen (MTS) and External Monitor .
Previously connected device is unavailable and is grayed out in the Options > Devices page	The device is no longer present.	Touch-and-hold (right-click) the device graphic in the Options > Devices page and choose Forget <device> to dismiss warning dialogs.
	Bad or missing connection to the E6L engine.	Check to make sure the cable connecting the device to the is properly connected and not damaged, and that the device is powered on.

Table 8. Troubleshooting Errors and Messages

Symptom or Message	Possible Cause	Solution
Startup and Restarts		
Repeated failures	An incompatible plug-in, a corrupted data file or application software, or a hardware error.	<p>Check to make sure you are using the most current versions of all your plug-ins (check with the manufacturers). If failures occur only when you try to use a certain plug-in, disable that plug-in and see if problems go away. Try re-installing plug-ins that are causing problems.</p> <p>Determine if a certain Show file causes the system to fail consistently. If so, delete that file and see if problems persist. For additional options, see Restarting Your System. Clear the console from the Options > System page and see if problems persist.</p> <p>If necessary, you can reinstall VENUE software by doing a System Update. If you suspect problems with the system hard drive, or the system software, you can do a complete restore (see the <i>VENUE S6L Installation Guide.pdf</i>). Power down all equipment and check all cards and cable connections and power supplies.</p>
Plug-Ins		
The plug-in racks need to be reset	The plug-in racks have gone offline, and LOST is indicated in the Status box on-screen. The racks go offline after some conditions in which a plug-in or the DSP host failure causes significant problems.	Follow the instructions on-screen to reset the racks (see Resetting the Plug-In Racks).
One or more plug-ins are unavailable	A Show was loaded that references plug-ins which are unavailable on the current system.	Install the plug-ins, if available (see Installing and Authorizing Plug-Ins). Remove or replace the plug-ins in the Show, or load a different Show file.
	A plug-in is not fully compatible and is causing failures.	Check all plug-ins to make sure you are using the most recent versions. Go to Options > Plug-Ins and Click the plug-in to display the version number. Try disabling plug-ins one-by-one to see if doing so eliminates problems (see Enabling and Disabling Installed Plug-Ins).
Plug-in authorization dialogs appear every time the system starts or restarts	A plug-in is installed that needs to be authorized for demo or full use.	Click Quit to dismiss the authorization dialog and continue starting up (the plug-in will be unavailable). Click Try to use the plug-in for a limited time in Demo mode. Click Authorize if you are ready to authorize a plug-in using an iLok. (See Installing and Authorizing Plug-Ins .)
	A plug-in demo has expired.	Uninstall the plug-in listed in the authorization dialog (see Uninstalling Plug-Ins).

Table 8. Troubleshooting Errors and Messages

Symptom or Message	Possible Cause	Solution
Warning Dialogs		
One or More Devices Have Failed	Bad or missing connection	Check connections to other components.
	A device needs to be reset.	Reset the device. If unable to reset the device, power cycle the device.
Plug-In Racks Need Reset	The racks have gone offline because a plug-in has failed, or some circumstances have caused the DSP engines to require a reset.	Follow the instructions on-screen to reset the racks (see Resetting the Plug-In Racks).
Console Connection Error	Bad or missing connection	Check Network connections to the E6L engine.
	A unit needs to be reset.	Reset the device. If unable to reset the device, power cycle the device.
Date & Time Check	System clock needs to be reset.	Reset the system clock. See Setting the System Clock .
Sample Rate Conversion Alert SRC OFF LEDs flashing (Systems with DSI option only)	A sample rate mismatch or lack of clock has been detected at a digital input.	No immediate action required; automatic sample rate conversion maintains digital throughput, allowing you to check settings and connections between VENUE and external digital devices later. For more information on digital connections and synchronization, see Synchronizing AES/ADAT Digital Audio Inputs (SRC) .
Hardware Monitor Alert	The system has detected a hardware component that is performing above or below its hardware specification.	Click HW Monitor to access the Hardware Monitor Window for the device. See Resetting Hardware Components .
A Device Has Been Lost	A Stage 64 has been disconnected or has lost power.	Check power and/or connection to the device. If the device is not present, right-Click the graphic of the corresponding Stage 64 and choose Forget IO Box Assignment.
Control Surface Module Lost	Network error	See Restarting Your System .
Redundant Connection Lost	If a primary and redundant audio connection has been made to the device, one of the connections has been lost.	Check the audio network connection to the device. If a redundant connection is not present, press OK to dismiss the dialog.
Engine Internal Switch Warning	Internal switch in the E6L engine has malfunctioned	Power-cycle the E6L engine
One or more Engine fans have stopped working	One or more fans inside the E6L engine have failed	When possible, check the internal fan connections.
2 fan blocks in the Engine have stopped working. Your Engine will now shut-down to prevent overheating.	All fans inside the E6L engine have failed.	The E6L engine will not operate unless at least one fan block is operational. When possible, check the internal fan connections, and replace the fans is necessary.
External power supply of HDX card(s) is disconnected.	Power cable is not connected to one or more HDX cards in the E6L engine.	Shut down the E6L engine and check power connections to HDX cards. See the <i>HDX-192 DSP Installation Guide</i> for instructions on accessing the HDX cards and their power cables.
Unsupported HDX DSP configuration detected	HDX DSP card may be installed improperly	Make sure you have installed your HDX DSP card in the correct slot in the E6L engine. See the <i>HDX-192 DSP Installation Guide</i> for instructions on properly installing the HDX cards.
HDX DSP card requires update	The version of the firmware on an HDX DSP card in the E6L engine is incorrect	See Updating HDX-192 DSP Card Firmware .

Table 8. Troubleshooting Errors and Messages

Symptom or Message	Possible Cause	Solution
MADI card requires update	The version of the firmware on a MADI-192 MADI Option card is incorrect.	See Updating MADI Card Firmware .
Clock Lost (or similar)	The system(s) might be connected in an unsupported clock configuration.	Make sure the WCOOut port on the MADI-192 MADI Option card is not connected. For more information, see Connecting and Using the MADI-192 MADI Option Card .
VENUE On-Stage		
Enter Password. Access to this VENUE system is locked.	Password protection has been enabled for VENUE On-Stage.	See the <i>VENUE On-Stage.pdf</i> for instructions on enabling, configuring, disabling, and resetting password protection.

Restarting Your System

If your VENUE system ever needs to be reset, restart the system

To restart the system:

- 1 On the external screen, go to the Options > System page.
- 2 Hold Default (Alt) and select Shut Down.

If restarting the system does not correct a problem, you may have to reset hardware components, identify and remove any incompatible plug-ins, or reinstall VENUE software using the System Restore software.

Additional Reset Options

Additional shortcuts are provided while restarting the system, which let you do the following:

- Back up the current show settings and clear the console. Use this option if you suspect an auto-saved setting has become corrupted. This lets you save your most recent settings and clear the console without having to do a full system restore.
 - or –
- Startup in Explorer, to be able to manually manage software components. Use this option to troubleshoot the system if problems arise early in the startup process and persist through repeated restarts.

Backup and Clear Console

To backup and clear the console at restart:

- 1 Start or restart the system.
- 2 Watch the screen closely during the startup process. As soon as the cursor becomes visible (and before the VENUE software logo screen appears) press and hold the C key on the computer keyboard. Continue to hold the C key (do not press it repeatedly).
- 3 A dialog appears that lets you choose to backup your auto-saved settings and clear the console, or to continue and load settings normally.



If you press the C key too early in the startup process, the USB keyboard is reset instead of calling the Backup and Clear dialog. If you do not see the backup and clear dialog, repeat the restart process and try again.

Startup in Explorer

To start up the system in Explorer (bypassing VENUE software):

- 1 Start or restart the system, as necessary.
- 2 Watch the screen closely during the startup process. As soon as the cursor becomes visible (and before the VENUE software logo screen appears) press and hold the E key on the computer keyboard. Continue to hold the E key (do not press it repeatedly) until you see the Explorer desktop.
- 3 From Explorer, you can manually find and delete suspect data files, plug-ins, or perform other file management tasks.



If you are unsure about how to troubleshoot a computer and its files, it is recommended that you contact VENUE customer service.

Resetting Hardware Components

Some hardware can be reset from external screen Options > Devices screen, or by power-cycling the component. It is recommended that you perform a reset if, for example, the Hardware Monitor Alert dialog appears for a specific device, if a connected device stops communicating with the rest of the system, or if the device is not passing audio signal via its I/O.

To reset system hardware:

- 1 Put the system in Config mode.
- 2 On the external screen, go to Options > Devices.
- 3 Tap-and-hold (right-click) one of the following displayed hardware components:
 - S6L control surface
 - Stage 64 I/O racks (must be in the Connected Devices column)
- 4 Choose Reset.

Resetting Channel Touch Modules (CTMs)

If a CTM unexpectedly goes offline, indicated by Meters or Channel view not appearing on a CTM or a “Please Configure Console” message appearing, you can reset it from the MTS Control Surface Configuration page.

To reset an offline CTM:

- 1 On the MTS, touch the Gear icon.

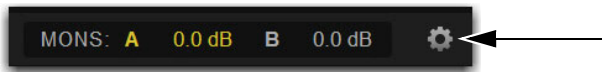

Gear icon

- 2 Touch the Control Surface Configuration button.

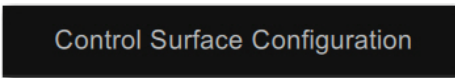

Control Surface Configuration button

The on-screen graphic show the status of the modules in your control surface

- 3 On the control surface graphic, tap the CTM that corresponds to the CTM that has gone offline, indicated by a warning icon. In the Diagnostics window below the control surface graphic, information about the CTM’s status appear.

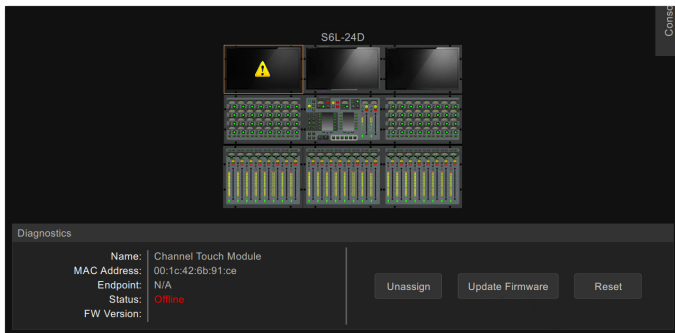

Control Surface Configuration window showing and offline CTM

- 4 Touch the Unassign button to release the connection.

- 5 Touch **Assign**. The selected CTM flashes to indicate it is the module targeted for assignment.
If the wrong module is flashing, touch **Cancel**, touch the correct module so it is bordered in orange, and then touch **Assign**.

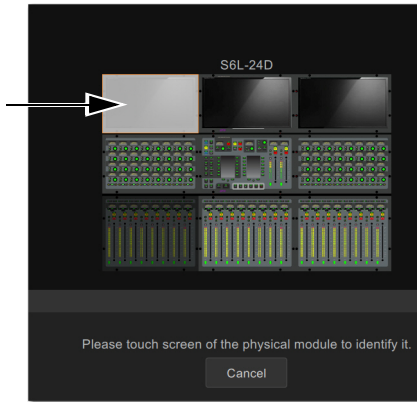

Control Surface Configuration window showing a CTM ready to be assigned

- 6 Touch the real CTM, which displays the message “Touch to Configure.”



CTM showing Touch to Configure

When the CTM has been reconnected, the Meters view appears on-screen.

Offline or Unavailable Devices

The S6L system remembers the last hardware configuration used. If it doesn't find all units at the next startup, it displays those devices as grayed out in the Options > Devices page. Devices remain offline (and the system displays error messages alerting you to their absence) until either the devices are powered up and come online, or you tell the system to “forget” the offline devices.

Forget an offline device if that device is not currently a part of your configuration. If your device has failed or lost its connection, check audio network connections or power-cycle the device.

To forget offline devices:

- 1 On the external screen, go to the Options > Devices page.
- 2 Touch-and-hold (right-click) the missing device and choose **Forget**.

Hardware Monitoring Window

The performance of hardware components, including internal temperatures, can be viewed and monitored using the Hardware Monitoring window.

Should a problem occur with any of the components in your system, the Hardware Monitoring window will provide information that will be useful in troubleshooting while in contact with VENUE customer service.

Accessing Hardware Monitoring

To access the Hardware Monitoring window, do any of the following:

- Press Ctrl+Shift+M at any time to open the Hardware Monitoring window.
- On the Options > Devices page of the external screen, select a system component so it is highlighted in blue, and then in the Information section choose Status.
- If the Hardware Monitoring Alert dialog appears on-screen, select OK in the dialog. The Hardware Monitoring Alert dialog for the problem device appears automatically and identifies the reading that is out of specification.

The Hardware Monitoring Alert window is only displayed once per device (should a problem ever be detected with that device).

E6L Engine Emergency Shutdown

If the E6L engine has been disconnected from the S6L control surface and cannot be shut down via the Shut Down button on the Options > System page of the external VENUE software screen, you can shut the engine down using the front-panel **Reset** button.

To perform an emergency shut down of the E6L engine:

- Press and hold the **Reset** button on the front panel of the E6L engine for at least 5 seconds.
When the System LED goes dark and the Status LED lights amber, you can then power off the engine's PSUs.

Utility Mode

Each module on the S6L control surface (except CTMs) can be started up into a Utility mode that can be useful for troubleshooting purposes. Only use Utility mode at the request of a qualified Avid technician to diagnose specific hardware problems.

To enter Utility mode on the MLM:

- Press and hold the **Multi-Select** and **Multi-Assign** switches.

To enter Utility mode on a CFM:

- Press and hold the **Menu** and **Safe** switches on the leftmost channel strip.

To enter Utility mode on a CKM:

- Press and hold the encoder **Sel** switches on leftmost top-row encoders.

Resetting the Plug-In Racks

If the plug-in racks go offline they need to be reset to resume normal operation.

 *Do not reset the racks until there is a long enough break in the performance that the rack can be fully rebuilt with no signal passing through. This is especially important when using crossover plug-ins or gain-attenuating plug-ins.*

The following conditions apply when plug-ins go offline:

- When offline, plug-ins on input channels and continue to pass and process audio using their settings at the time the racks went offline.
- Offline plug-ins on output channels and buses are muted.
- You will not be able to adjust plug-ins settings until the racks fully re-initialize.
- Once the racks begin to reinitialize, plug-ins are unavailable and do not process audio.
- During reinitialization, plug-ins are loaded into rack slots according to the last loaded Show file; plug-in racks are turned off (all assigned plug-ins are made inactive).
- When all plug-ins have loaded and the racks initialized, the system displays a dialog alerting you that the racks are ready to be brought back online (reactivated). This is provided as a final precaution against sudden changes to audio when plug-ins resume processing.

Shortly after you confirm that you want the racks brought back online, plug-ins resume processing audio and all parameters become available for editing.

To re-initialize (reset) the racks:

- 1 In the Plug-In Racks Reset dialog, Click **Reset** to begin the plug-in rack re-initialization.
- 2 In the Plug-In Racks are Ready dialog, Click **Use Racks** to confirm that you want the racks to be reset. Status is shown on-screen. After the process is complete, the console and all plug-ins are operational again.

Using the System Restore Software

Use the System Restore software for troubleshooting or maintenance purposes. The S6L control surface and the E6L engine each have their own unique System Restore image, which you must install on each device separately. S6L control surface and E6L engine must both be running the same versions of VENUE software in order for them to connect. An active Internet connection is required to activate software components after installation.

See the most recent edition of the *VENUE | S6L Installation Guide.pdf* (available in your Avid account) for complete instructions on creating bootable USB drives for System Restore software, performing a System Restore or Software Update, and re-installing plug-ins.

 *Check your Avid account for the latest version of the System Restore software. Always make sure to use the latest version of the System Restore software when restoring your software, and that you always keep a copy of the System Restore software on-hand for troubleshooting.*

Updating HDX-192 DSP Card Firmware

If you have installed an HDX-192 DSP card in your E6L engine, and on startup you encounter the message that the firmware needs to be updated, use this procedure to update the firmware on the HDX DSP card.

To update the firmware on your HDX-192 DSP card:

- 1 Shut down your system, and power off all components.
- 2 Connect a VGA monitor, and USB keyboard and mouse to your E6L engine.
- 3 Power on your E6L engine, and repeatedly press F5 on the keyboard while the engine starts up.
- 4 Close the window that appears on screen to show the Desktop.
- 5 Double-click the Update HDX Firmware icon on the Desktop.
- 6 Follow the on-screen instructions to update the firmware on your HDX card.
When the firmware update completes, the E6L engine shuts down, indicated by the front-panel System LED going dark, and the Status LED lit amber.
- 7 After the E6L engine shuts down, disconnect the VGA monitor, keyboard, and mouse, and power-cycle your E6L engine.

Updating MADI Card Firmware

If you have installed one or more MADI-192 MADI Option Cards in your E6L engine and on startup you encounter the message that the firmware needs to be updated, use this procedure to update the firmware on the MADI card(s).

To update MADI-192 MADI Option Card firmware:

- 1 Shut down your system, and power off all components.
- 2 Connect a VGA monitor and USB keyboard and mouse to your E6L engine.
- 3 Power on your E6L engine, and repeatedly press F5 on the keyboard while the engine starts up.
- 4 Close the window that appears on screen to show the Desktop.
- 5 Double-click the Update MADI Firmware icon on the Desktop.
- 6 Follow the on-screen instructions to update the firmware on your MADI-192 MADI Option Cards.
When the firmware update completes, the E6L engine shuts down (indicated by the front-panel System LED going dark, and the Status LED lighting amber).
- 7 After the E6L engine shuts down, disconnect power from the E6L and wait at least 30 seconds.
- 8 Make sure to disconnect the VGA monitor, mouse, and keyboard, then power your system back on.

Configuring S6L Master Touch Screen (MTS) and External Monitor

If you replace your monitor and touch is not responding correctly on your MTS and/or your external monitor, use the Touch Screen Assignment wizard to configure your touchscreens. This wizard only applies to the MTS and the external monitor.

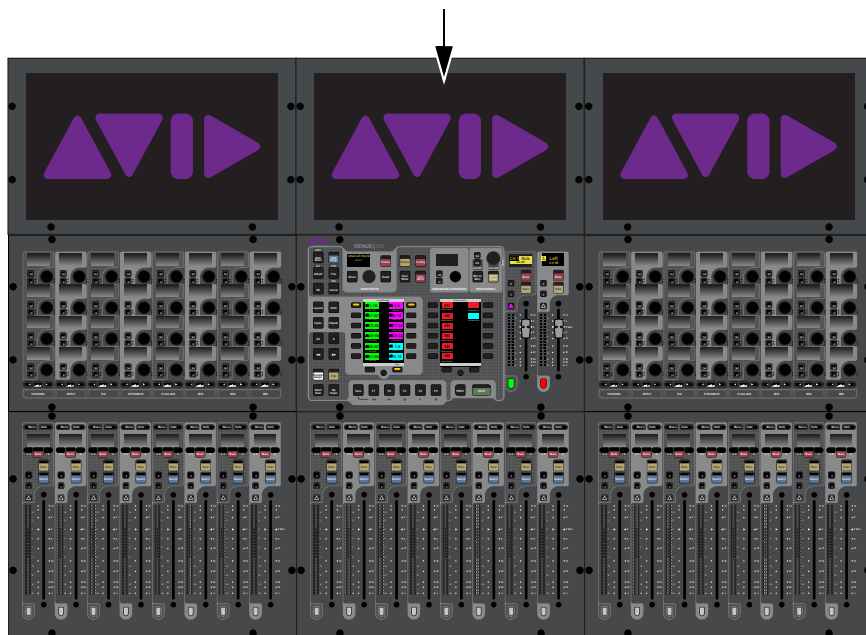

MTS on an S6L-24D

To configure your screens:

- 1 Make sure your DVI monitor is connected to your S6L control surface and is powered-on.
- 2 On the MTS, touch the Gear icon.
- 3 Touch General, then touch Touch screen assignment.
- 4 Follow the on-screen prompts to configure your touchscreens. If prompted to press Enter, press the **Enter** key on your keyboard.

LED Brightness

Module LED Brightness Settings let you adjust the brightness of switch LEDs and knobs to match the brightness of modules of varying ages or revisions. Using the Console Configuration page you can adjust brightness levels for knob and switch LEDs separately, and copy/paste all brightness settings from one module to another.

To adjust module brightness:

- 1 Access the Control Surface Configuration view by doing the following:
 - S6L-32D/24D/24C: On the MTS touch the Gear icon, then touch the Control Surface Configuration tab.
 - S6L-16C: On the external screen, go to Options > Control Surface Configuration.
- 2 On the control surface graphic, tap to select a module. The Diagnostics section appears below, showing module status and LED brightness controls.



Control Surface Configuration view (MTS shown)

- 3 To choose a preset LED Mode for the selected module, choose LED A or LED B from the drop-down menu.
 - LED A Maximum brightness, as found on newer or later revision S6L modules (100% for knobs and switches).
 - LED B Less bright, to match newer replacement modules with older modules (Switch = 20/30/10%; Knob = 70/100/60%).
- 4 To customize settings, choose USER from the drop-down menu. The brightness controls for Switch and Knob become lit/active.

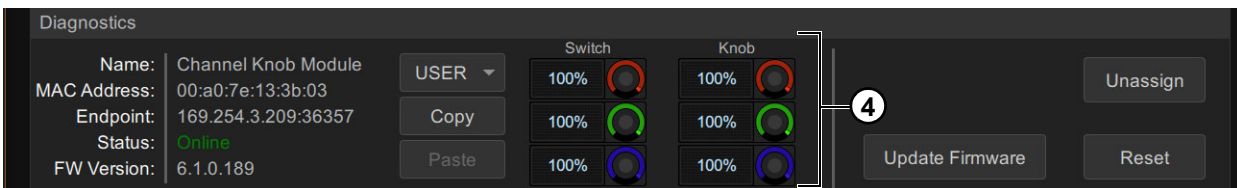

USER mode

- 5 Adjust the red, green, and blue encoders for Switch and Knob.
- 6 To copy/paste the current brightness settings, tap Copy, tap to select a different module, then tap Paste. Settings can be copied/pasted from any type of module to any other (such as copying CKM settings to a CFM).
- 7 Repeat for other modules, as desired.

Part VI: Specifications

Mechanical Specifications

S6L-16C Control Surface

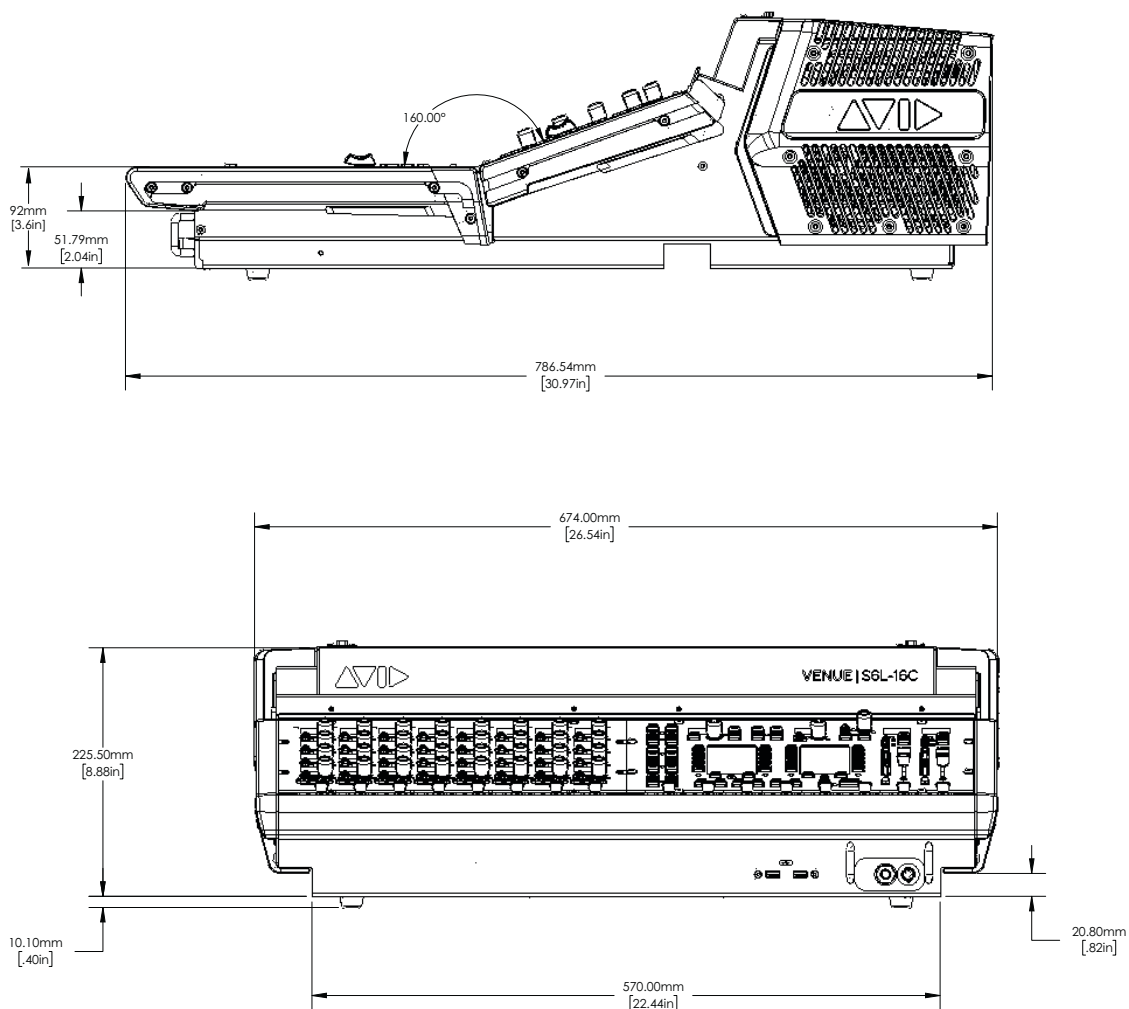

S6L-16C Control Surface Dimensions

Parameter	Specification
Maximum Height, Front	3.6 inches (92 mm)
Maximum Height, Back	8 inches (205 mm)
Maximum Width	26.5 inches (674 mm)
Maximum Depth	31 inches (787 mm)
Weight	70.5 lbs (38 kg)

S6L-24C Control Surface

Parameter	Specification
Maximum Height, Front	3.6 inches (92 mm)
Maximum Height, Back	8 inches (205 mm)
Maximum Width	38.9 inches (989 mm)
Maximum Depth	31 inches (787 mm)
Weight	84 lbs (38 kg)

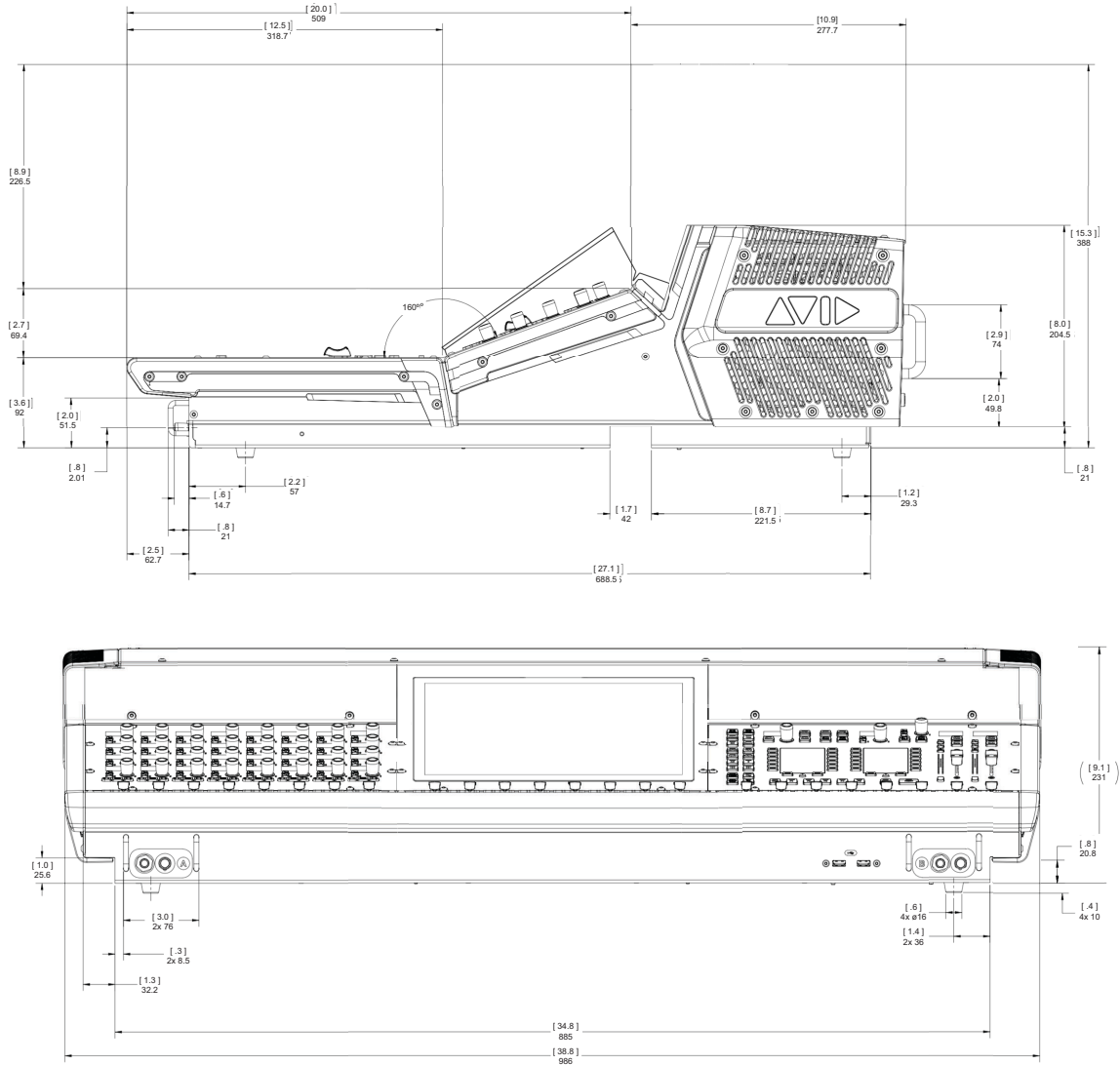

S6L-24C Control Surface Dimensions

S6L-32D Control Surface

Parameter	Specification
Maximum Height, Front	3.6 inches (92 mm)
Maximum Height, Back	15.3 inches (388 mm)
Maximum Width	51.2 inches (1302 mm)
Maximum Depth	30.9 inches (786.5 mm)
Weight	154.5 lbs (70 kg)

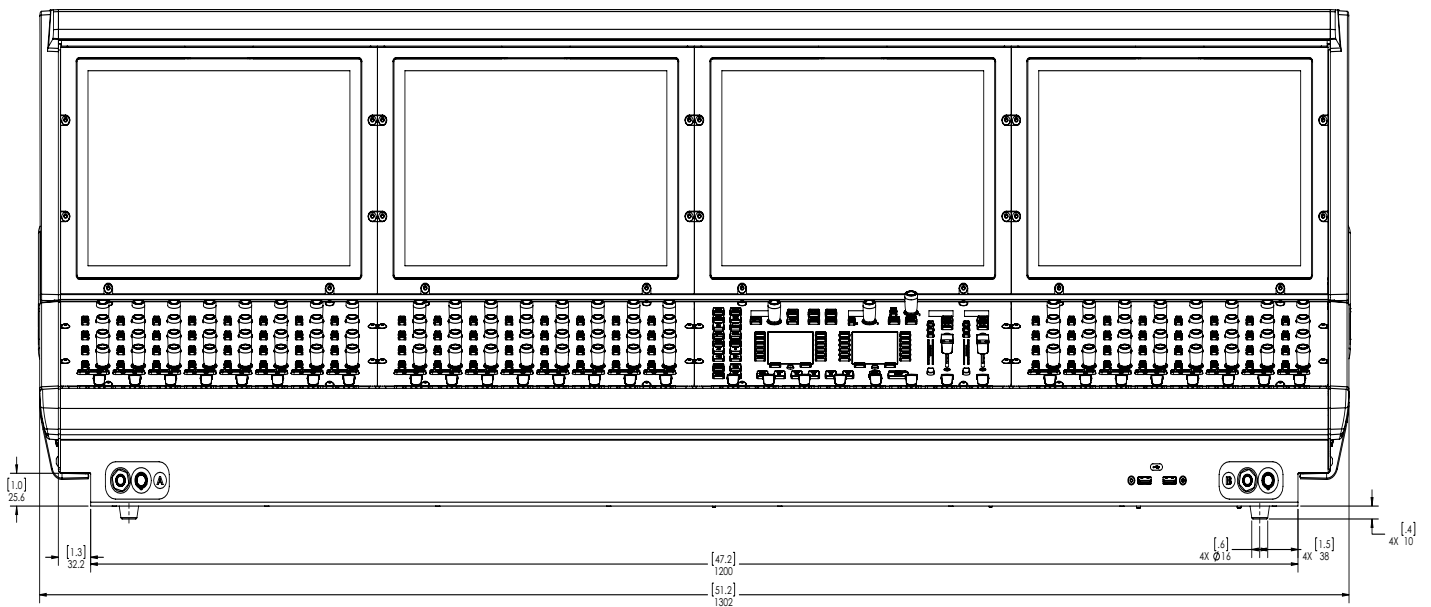
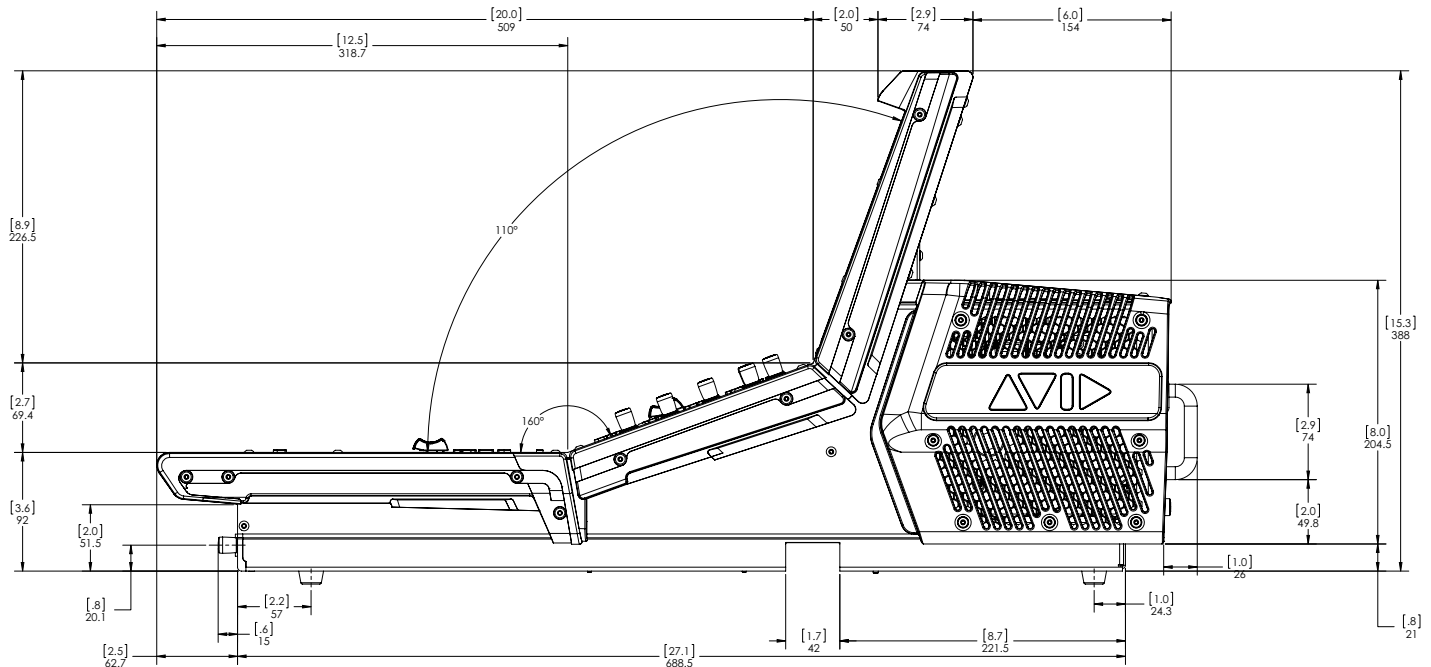

E6L Engine

Parameter	Specification
Maximum Height	8.6 inches (218.7 mm)
Rack Spaces	5U
Maximum Width	19 inches (483.7 mm)
Depth with Bezel Depth without Bezel	21.2 inches (537 mm) 19.6 inches (497 mm)
Weight	74 lbs (33.5 kg)

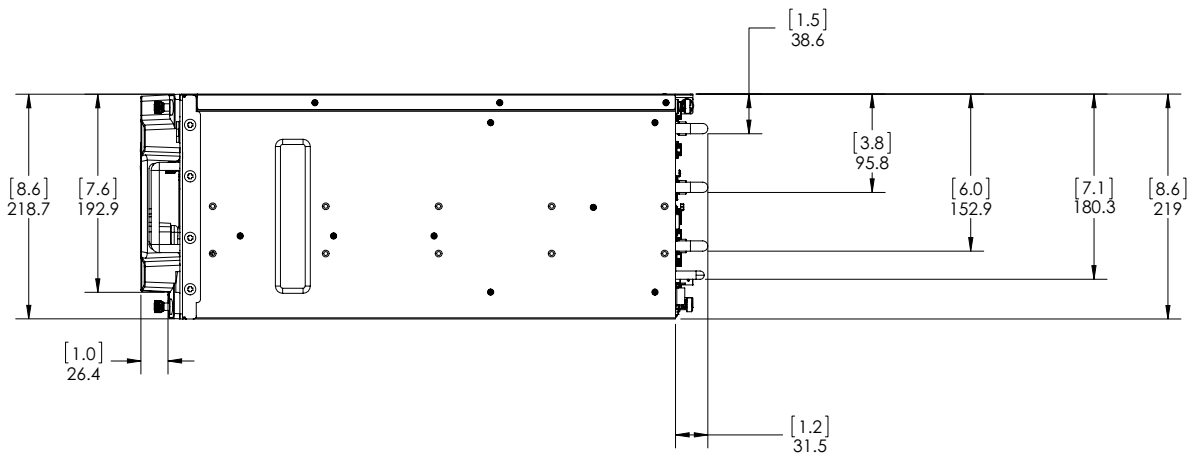
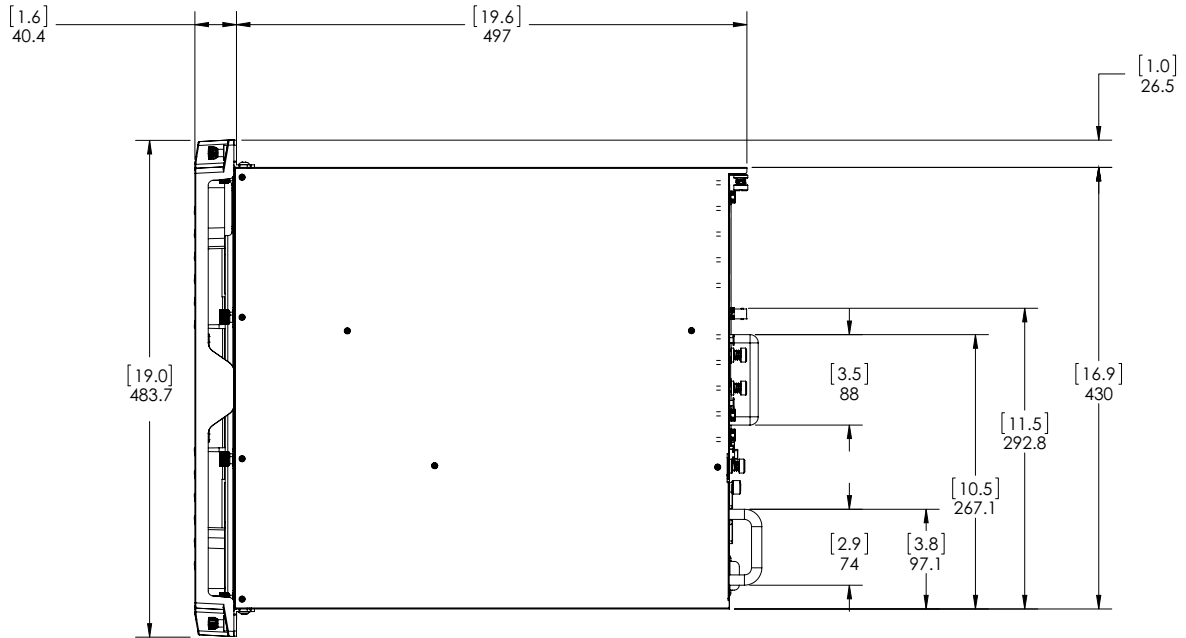

Stage 64

Parameter	Specification
Maximum Height	17.5 in (444.5 mm)
Rack Spaces	10U
Width with Rack Ears Width without Rack Ears	19 inches (483 mm) 17 inches (430.9 mm)
Maximum Depth	12.2 in (309.8 mm)
Weight	Empty: 46 lbs (20.8 kg); Full: 69 lbs (31.2 kg)

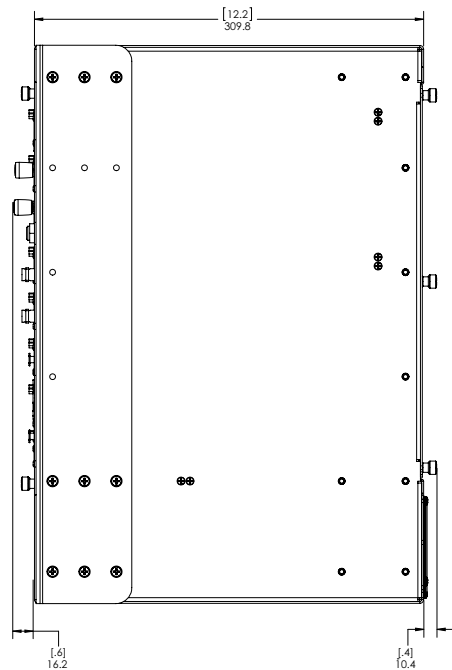
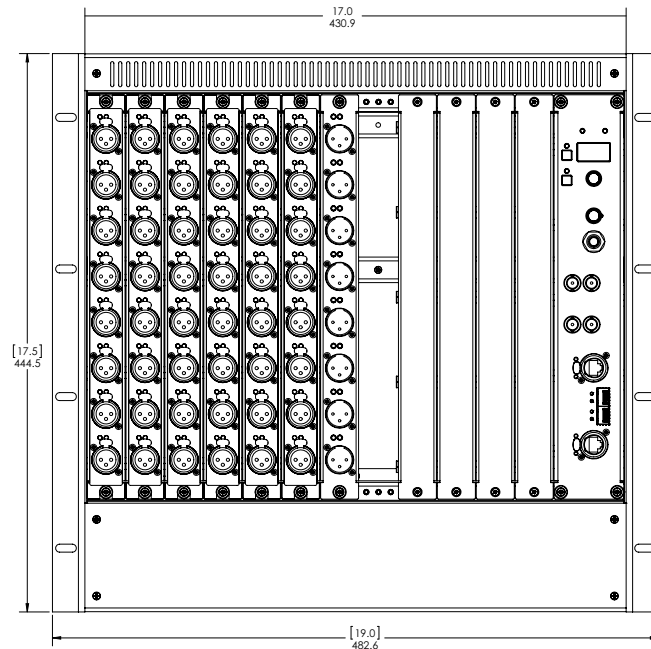

Stage 32

Parameter	Specification
Maximum Height	8.7 inches (221 mm)
Rack Spaces	5U
Width with Rack Ears	19 inches (483 mm)
Width without Rack Ears	17 inches (430.9 mm)
Depth	17.7 inches (448 mm)
Weight (Full)	49 lbs (22 kg)

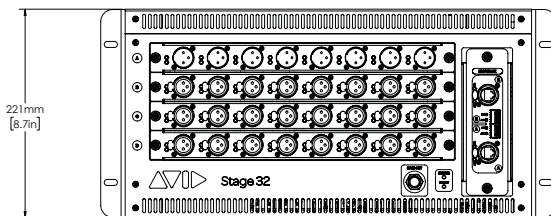
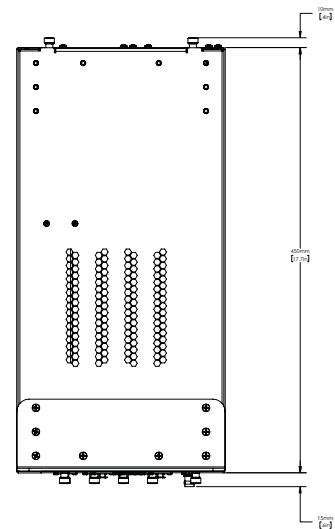
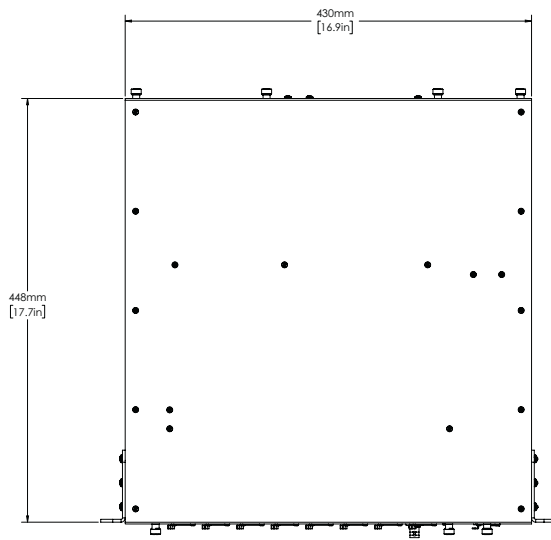

Stage 32

Stage 16

Parameter	Specification
Maximum Height	6.9 in (175.2 mm)
Rack Spaces	4U
Width (with Rack Ears) Width (Rack Ears configured as handles)	19 inches (483 mm) 15.6 inches (396 mm)
Depth (with Rack Ears) Depth (Rack Ears configured as handles)	7.9 in (201 mm) 9.8 in (249 mm)
Weight	21 lbs (9.5 kg)

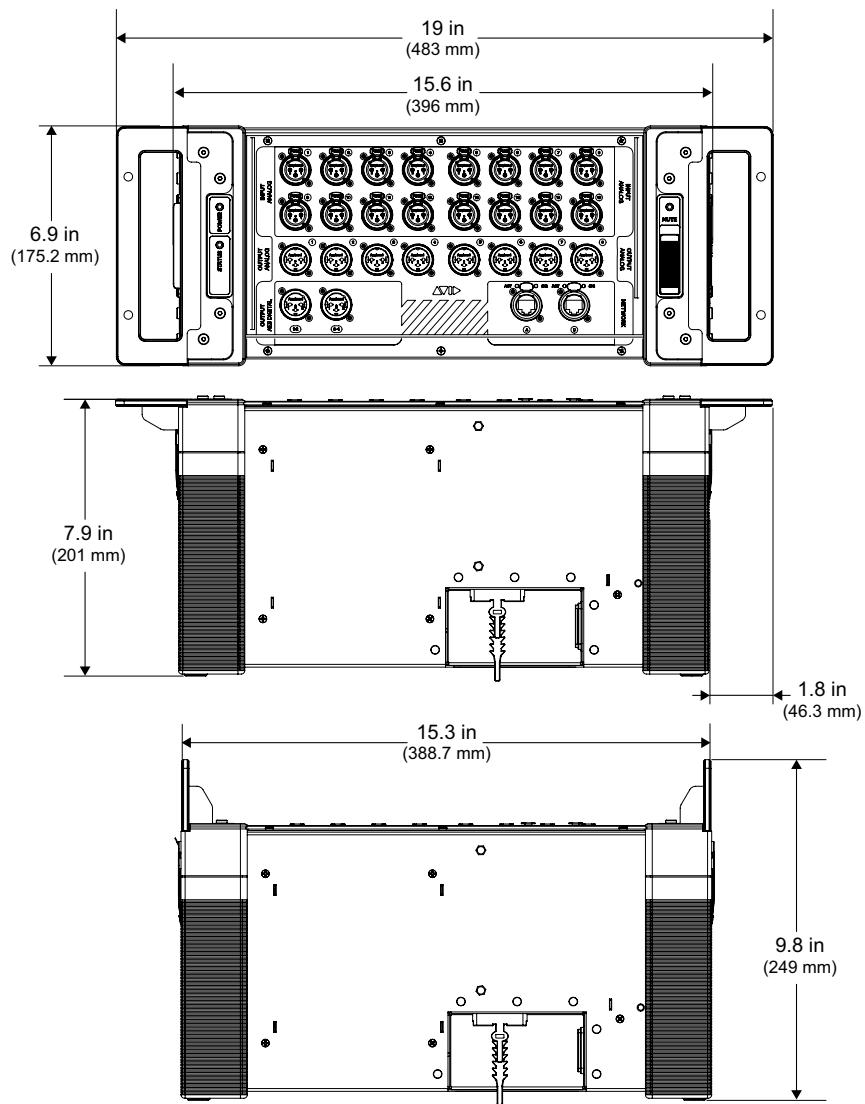

Local 16 I/O

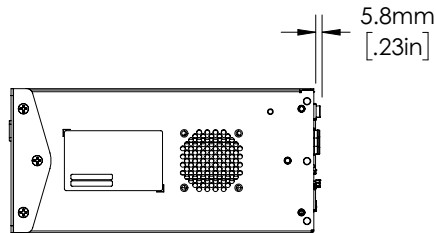
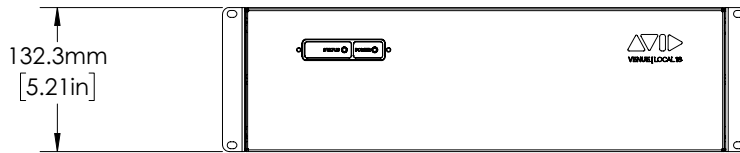
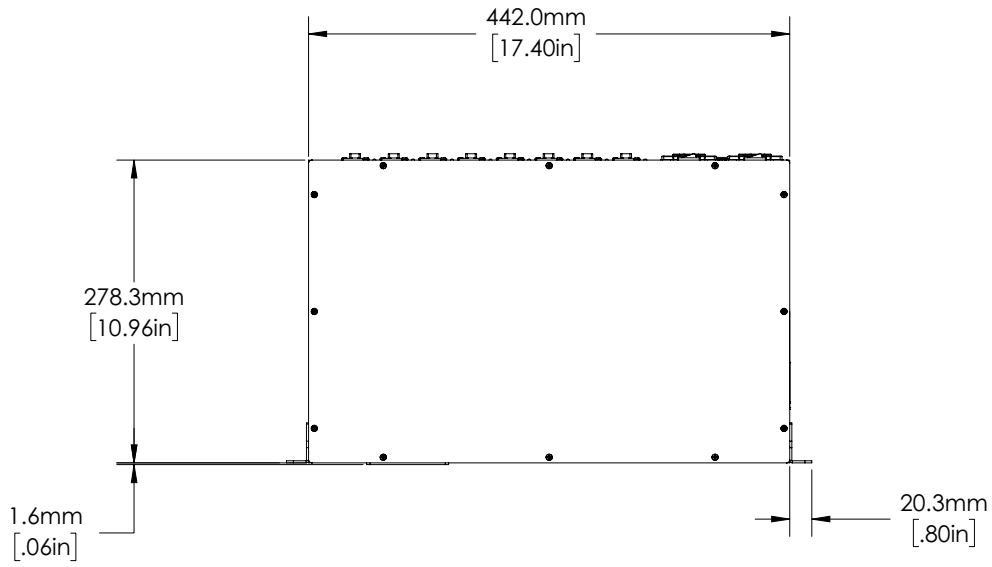

Local 16

Parameter	Specification
Maximum Height	5.2 inches (132 mm)
Rack Spaces	3U
Width with Rack Ears Width without Rack Ears	19 inches (483 mm) 17 inches (430.9 mm)
Depth	11 inches (278 mm)
Weight (Full)	16.3 lbs (7.4 kg)

S6L System Components LED Codes

E6L Engine

The Status and System LEDs on the E6L engine front panel light to indicate the following:

E6L engine front panel Status and System LEDs

LED	Color	State	Description
Status	Green	Solid	All clear (no hardware alerts are detected).
	Amber	Solid	One or more hardware alerts are detected. Consult the VENUE software Options > Devices page for detailed info.
	Off (unlit)	n/a	E6L is powered off, or is initializing during startup.
System	Green	Solid	E6L is fully operational, and connected to the S6L control surface
	Amber	Solid	E6L processor has shut down; safe to power off E6L.
		Flashing	E6L processor is initializing.
	Off (unlit)	n/a	E6L is powered off, or is initializing during startup.

On E6L-112 (only), a flashing System LED indicates a disconnected AC power cable.

Stage 64 and Stage 32



Power and fan faults are also communicated on-screen via a warning dialog box on the external VENUE software screen.

Status LED

The STATUS LED on the Stage 64 lights to indicate status as follows:

Stage 64 Status LED

LED Color	Description
Green solid	Initialization is complete and the device is ready to pass audio.
Green flashing	A firmware update for the device is in progress. No audio passes during a firmware update.

Fault LED

The FAULT LED on the Stage 64 lights to indicate status as follows:

Stage 64 Fault LED

LED Color	Description
Red solid	Fan failure. Power cycle the device.
Red flashing	Power supply temperature alert. This may indicate that the device is overheating. Power down the device and check that the device is properly ventilated.

Network Port Act and Sig LEDs

Each S6L control surface, E6L engine, and Stage 64 Network port has its own Activity (Act) and Signal (Sig) LEDs. Each device is ready for use when the Act and Sig LEDs are lit solid for each connected Network port.

Act LED The Act (activity) LED lights solid to indicate that AVB Ethernet traffic is currently active on the connected audio snake cable. If a redundant snake is connected, or if a Stage 64 is daisy-chained to another Stage 64, then ports A and B Act LEDs will be lit.

Sig LED The Sig (signal) LED lights solid to indicate that a valid communication connection exists between devices. If a redundant snake is connected, or if the Stage 64 is daisy chained to another Stage 64, then ports A and B Sig LEDs will be lit.

Replacing S6L and E6L PSUs

The S6L-32D and S6L-24D control surfaces, and the E6L-192 and E6L-144 engines use the same model of hot-swappable PSUs, and the procedure for replacing a faulty PSU is the same for both units.

To replace an S6L or E6L PSU:

- 1 On the back panel of the S6L or E6L, locate the faulty PSU, indicated by a red or not-lit PSU ON LED
- 2 Locate the PSU's captive thumbscrew, and rotate counter-clockwise to loosen, using a #1 Phillips screwdriver if necessary.
- 3 Using the handle, slide the PSU out of the unit.

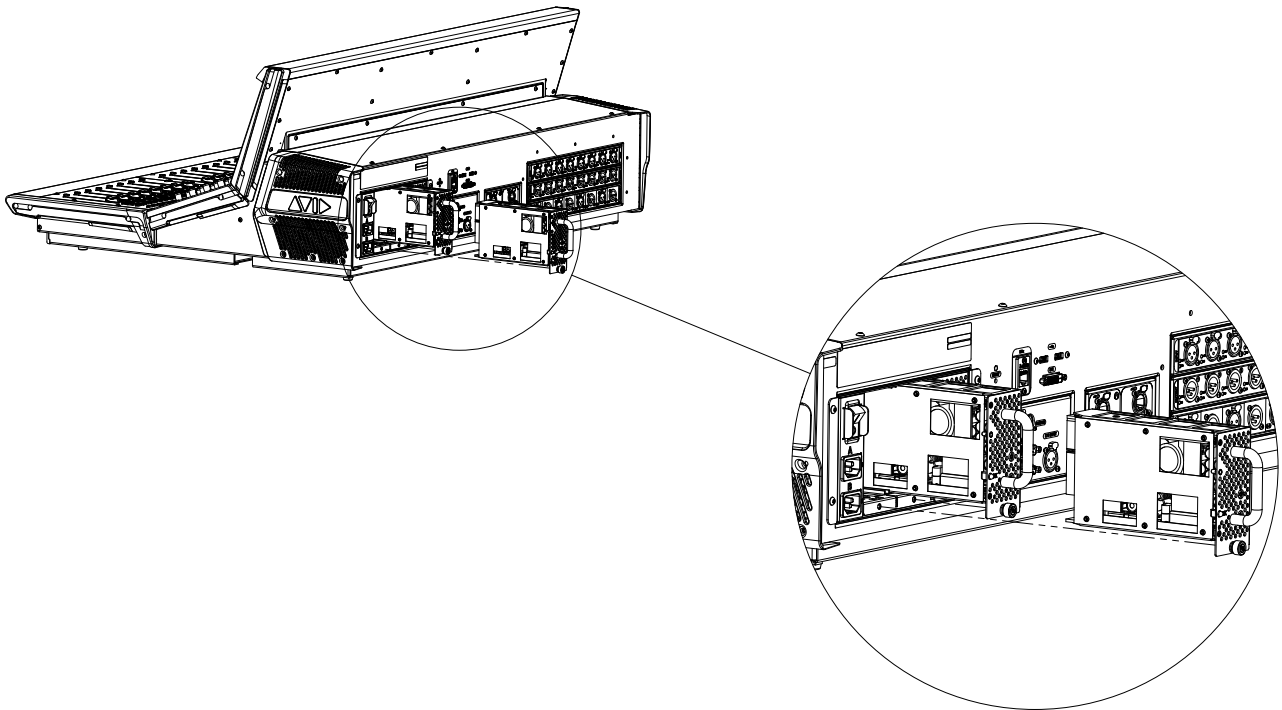

Removing PSUs from the S6L control surface

- 4 Slide the replacement PSU into the proper slot of the unit, and rotate the captive thumbscrew clockwise to tighten.

S6L Secure USB Port

The S6L control surface features a secure internal USB port to connect and securely protect an iLok containing plug-in licenses. Use this port to keep one “master” iLok and its plug-in assets with the S6L control surface at all times, safe from damage or loss. To access the port, the back cover of the S6L control surface must be removed. Only install the iLok after you have transferred plug-in licenses to your iLok. See [Installing and Authorizing Plug-Ins](#) for more information on handling plug-in licenses.

A 2.5 mm hex wrench is required to remove the back cover.

 The following image and instructions refer to an S6L-24D. The number of fasteners, and exact location of the secure USB port, may differ with other models of S6L control surface.

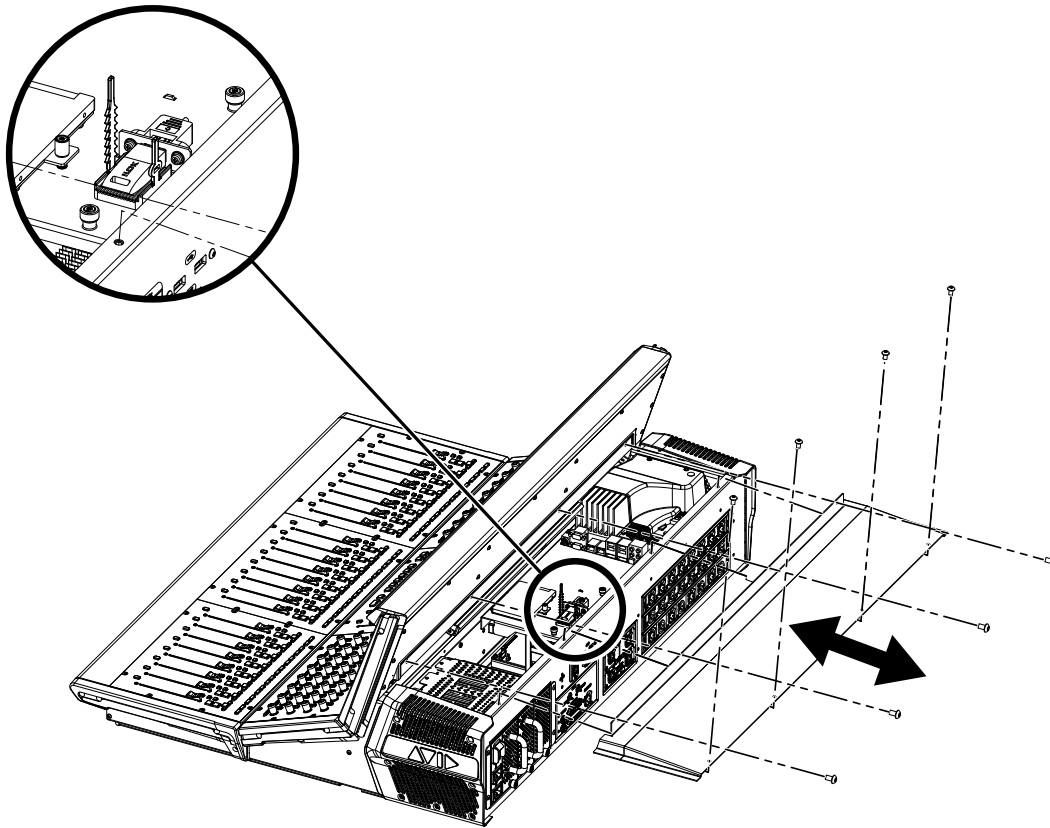

Figure 4. S6L control surface secure USB port (S6L-24D shown)

To access the secure USB port in the S6L control surface:

- 1 Power down and disconnect all cables from the S6L control surface.
- 2 Using a 2.5 mm hex wrench, remove the 8 screws that secure the back cover of the control surface, as indicated in Figure 4, and set the screws aside. (On S6L-16C, only, there are 6 screws to remove.)
- 3 Slide the panel away from the control surface, and set the panel aside. It may be necessary to loosen the end caps before the panel can be removed.
- 4 Inside the control surface, locate the secure USB port and insert the iLok.
- 5 Secure the iLok with the built-in cable tie. Be careful to not over tighten the cable tie (make sure the iLok does not bend or sag).
- 6 Replace the top panel, making sure the left and right edges of the top panel are under the top edges of the side cover (where the Avid logo appears) lips.
- 7 Reattach the eight screws removed earlier to secure the cover. If you loosened the end caps, be sure to re-tighten their screws.

Making Fiber-Optic Connections

When using fiber to connect S6L system components, you must use two SFP qualified transceiver modules per connection in addition to supported fiber-optic cable (see [Cabling Requirements](#) for information on supported cabling). To make a fiber connection to an S6L system component, insert the SFP transceiver module into a fiber Network port of an S6L system component, and then insert the fiber-optic cable into the SFP module.

⚠ *It is recommended that you do not install or remove an SFP module with a cable attached to it, or install or remove an SFP module more often than is necessary. Always cover fiber-optic ports and connector ends when they are not connected using dust caps and plugs.*

To make a fiber-optic connection to an S6L system component:

- 1 Remove the dust plug from the desired fiber Network port on the S6L system component, and set it aside for later use.

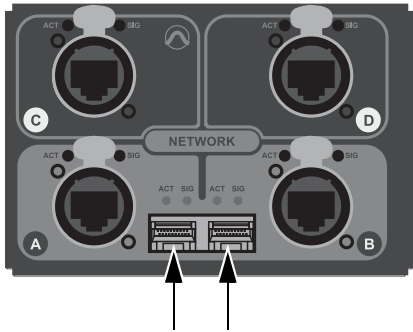

Fiber Network ports A (left) and B (right) on the S6L control surface (dust plugs removed)

- 2 Align the SFP module with the fiber Network port so that the release latch on the SFP module faces up (when installing in the S6L control surface or the E6L engine), or to the left (when installing in a Stage 64).
- 3 Insert the SFP module into the port until you feel the module snap into place inside the port.
- 4 Remove the dust plug from the SFP module's port, and set it aside for later use.
- 5 Remove the dust cap from the fiber-optic cable connector, align the connector with the port so that the tab on the top of the cable connector faces up (when installing in the S6L control surface or the E6L engine), or to the left (when installing in a Stage 64), and then insert the cable into the SFP module until you feel the cable connector snap into place.

To remove the fiber-optic cable from the SFP module:

- 1 Press the tab on the top on the cable connector to release the cable, and then pull the cable out of the SFP module.
- 2 Replace the dust cap on the end of the fiber-optic cable connector.

To remove the SFP module from the fiber port:

- 1 Pull the release latch on the SFP module out and down to release the module from the port, using a small flat head screwdriver if necessary.
- 2 Pull the module out of the port.
- 3 Replace the dust plug on the SFP module port and place the module in an anti-static bag.

Audio Specifications

All specifications subject to change.

System Processing

Parameter	Value
Internal Sample Frequency	96 kHz
Internal Processing	Up to 64-bit floating point
Processing Delay	2.83 ms (Stage 64 analog input, through Mains L-R bus to Stage 64 analog output)

Analog Mic/Line Inputs

Parameter	S6L Control Surface Analog Inputs (XLR)	SRI-192 Analog Input Card
Connector	8 XLR-F	8 XLR-F
Sample rate	96 kHz	96 kHz
Phantom Power	+48V	+48V
Input Sensitivity	+14 dBu (+/-0.25 dB) @1 kHz, Pad Off +34 dBu (+/-0.25 dB) @1 kHz, Pad On	+14 dBu (+/-0.25 dB) @1 kHz, Pad Off, +34 dBu (+/-0.25 dB) @1 kHz, Pad On
Pad Depth	20 dB (+/- 0.25 dB), 1 kHz, 50 Ohm	20 dB (+/- 0.25 dB), 1 kHz, 50 Ohm
Gain Accuracy	±0.25 dB @ all gains	±0.25 dB @ all gains
Gain	+10 dB to +60 dB Pad Off -10 dB to +40 dB Pad On	+10 dB to +60 dB Pad Off, -10 dB to +40 dB Pad On
Input Impedance	~4 k Ohms	~4 k Ohms
Frequency Response	20 Hz - 20 kHz -0.2 dB @ all gains	20 Hz - 20 kHz ±0.1 dB @ all gains
THD+N	<0.0004% @+2 dBu, @1 kHz, @20 dB gain, 20 Hz-20 kHz filter, <0.0005% 20-20 kHz, @+10 dBu, @10 dB gain, 20 Hz-20 kHz filter	<0.0004% @+2 dBu, @1 kHz, @20 dB gain, 20 Hz-20 kHz filter, <0.0005% 20-20 kHz, @+10 dBu, @10 dB gain, 20 Hz-20 kHz filter
EIN	-127 dB, 150 Ohm source, 20 Hz - 20 kHz	-127 dB, 150 Ohm source, 20 Hz - 20 kHz
Converter Group Delay	12.6/Fs = 0.131 ms	12.6/Fs = 0.131 ms
Dynamic Range	>118 dB, A - weighted @ 1 kHz	>118 dB, A - weighted @ 1 kHz
CMRR	>60 dB @60 Hz >80 dB Typical, @100 Hz, 20 dB gain >70 dB Typical, 20 Hz-20 kHz, 20 dB gain	>60 dB @60 Hz >90 dB Typical, @100 Hz, 20 dB gain >80 dB Typical, 20 Hz-20 kHz, 20 dB gain
LEDs	Signal Present (green), +48V (red)	Signal Present (green), +48V (red)

Analog Line Outputs

Parameter	S6L Control Surface Analog Outputs (XLR)	SRO-192 Analog Output Card
Connector	(8) XLR-M	(8) XLR-M
Sample rate	96 kHz	96 kHz
Output Sensitivity	+24 dBu (+/-0.25 dB) @1 kHz, 100 k ohm	+24 dBu (+/-0.05 dB) @1 kHz, 100 K ohm
Gain Accuracy	±0.25 dB, 20-20 kHz, all gain settings	±0.25 dB, 20-20 kHz, all gain settings
Frequency Response	20-20 kHz, -0.15 dB	-0.1 dB, 20-20 kHz
THD+N	<0.0005% @1 kHz, -5 dBFS <0.0005%, 20-20 kHz, @-5 dBFS	<0.0006% @1 kHz, -5 dBFS <0.0008%, 20-20 kHz, @-3 dBFS
Converter Group Delay	7/Fs = 0.073 ms	7/Fs = 0.073 ms
Dynamic Range	>117.5 dB, A-weighted @1 kHz	>116 dB, A-weighted @1 kHz
Mute Depth	>125 dB @1 kHz, @-10 dBFS >115 dB 20-20 kHz, @-10 dBFS	>125 dB @1 kHz, @-10 dBFS >115 dB 20-20 kHz, @-10 dBFS
Output Impedance	100 Ohms Differential	100 Ohms Differential
Crosstalk	>120 dB @1 kHz, @-10 dBFS >100 dB 20-20 kHz, @-10 dBFS	>120 dB, @1 kHz, @-10 dBFS >100 dB, 20-20 kHz, @-10 dBFS
LEDs	Signal Present, Mute	Signal Present (green), Mute (red)

S6L Control Surface Digital I/O

Parameter	S6L Control Surface Digital Inputs	S6L Control Surface Digital Outputs
Connector	(4) XLR-F	(4) XLR-M
Format	AES 3 (AES/EBU)	AES 3 (AES/EBU)
Word Length	24-bit	24-bit
Termination	110 Ohms	110 Ohms
Max Cable Length	328 feet (100 meters)	328 feet (100 meters)
Supported Sample Rates	24 kHz to 210 kHz per input pair (SRC is always active)	96 kHz
Level	n/a	~3.6V pp maximum (i.e., +/- 1.8V)
Channel Status Info	n/a	Pro Audio 96 kHz, No Emphasis
Dithering	n/a	No
LEDs	n/a	Signal Present (green), Mute (red) per AES pairs

DSI-192 Digital Input Card

Parameter	AES Digital Inputs	ADAT Digital Inputs	Word Clock Out
Connector	(4) XLR-F	TOSLINK Optical	BNC-F
Format	AES 3 (AES/EBU)	ADAT, 8-channel @ 48 kHz, 4 channels @ 96 kHz, 2 channels @ 192 kHz (selectable within software)	Word Clock Out
Word Length	24-bit	24-bit	n/a
Termination	110 Ohms	110 Ohms	n/a
Max Cable Length	328 feet (100 meters)	n/a	n/a
Supported Sample Rates (with SRC)	24 kHz to 210 kHz per input pair (defeatable within software)	24 kHz - 210 kHz	n/a
Source Impedance	n/a	n/a	75 Ohm
Drive Level	n/a	n/a	2.5 pk-pk into 75 Ohm load
LEDs	Lock, SRC On	Lock, SRC On	n/a

DSO-192 Digital Output Card

Parameter	AES Digital Outputs	ADAT Digital Outputs
Connector	(4) XLR-M	TOSLINK Optical
Format	AES 3 (AES/EBU)	ADAT, 8-channel @ 48 kHz, 4 channels @ 96 kHz, 2 channels @ 192 kHz
Word Length	24-bit	24-bit
Termination	110 Ohms	110 Ohms
Max Cable Length	328 feet (100 meters)	n/a
Supported Sample Rates	96 kHz	48 kHz SMUX, 96 kHz SMUX and 192 kHz SMUX (selectable within software)
LEDs	Lock, SRC On	Lock, SRC On
Impedance	110 Ohm	n/a
Level	~3.6 Vpp maximum (i.e., +/- 1.8V)n/a	n/a
Channel Status Info	Pro Audio 96 kHz, No Emphasis	n/a
Dithering	NO	No
LEDs	Signal Present (green), Mute (red) per AES pairs	Signal Present

Headphone Outputs

Parameter	S6L Console Headphone Outputs	Stage 64 Headphone Output
Connector	(2) TRS-F	(1) TRS-F
Sample rate	48 kHz, 96 kHz, 192 kHz	48 kHz, 96 kHz, 192 kHz
Output Impedance	<3 Ohms	<3 Ohms
Max Output Power (rms)	>600 mW, 32 Ohm, 1 kHz, 1% THD, >190 mW, 300 Ohms, 1 kHz, 1% THD, >100 mW, 600 Ohms, 1 kHz, 1% THD	>750 mW, 32 Ohm, 1 kHz, 1% THD, >330 mW, 300 Ohms, 1 kHz, 1% THD, >190 mW, 600 Ohms, 1 kHz, 1% THD
Frequency Response	20-20 kHz, +/- 0.2 dB, -15 dBFS	20-20 kHz, +/- 0.1 dB, -15 dBFS
THD+N	<0.0007%, 1 kHz, -2 dBFS, >300 ohms, <0.0025%, 20-20 kHz, -5 dBFS, 300 ohms, 20 kHz filter, <0.0015%, 1 kHz, -5 dBFS, 32 ohms, <0.0025%, 20-20 kHz, -4 dBFS, 32 ohms, 20 kHz filter	<0.0005%, 1 kHz, 0 dBFS, >300 ohms, <0.0008%, 20-20 kHz, 0 dBFS, >300 ohms, 20 kHz filter, <0.0008%, 1 kHz, -4 dBFS, 32 ohms, <0.0015%, 20-20 kHz, -4 dBFS, 32 ohms, 20 kHz filter
Group Delay	7/Fs = 0.073 ms	7/Fs = 0.073 ms
Dynamic Range	>110 dB, 20-20 kHz, A-weighted	>110 dB, 20-20 kHz, A-weighted
Channel Separation	<-90 dB, 1 kHz, 600 Ohms	<-90 dB, 1 kHz, 600 Ohms

Signal Flow Diagrams

Input Channel Signal Flow

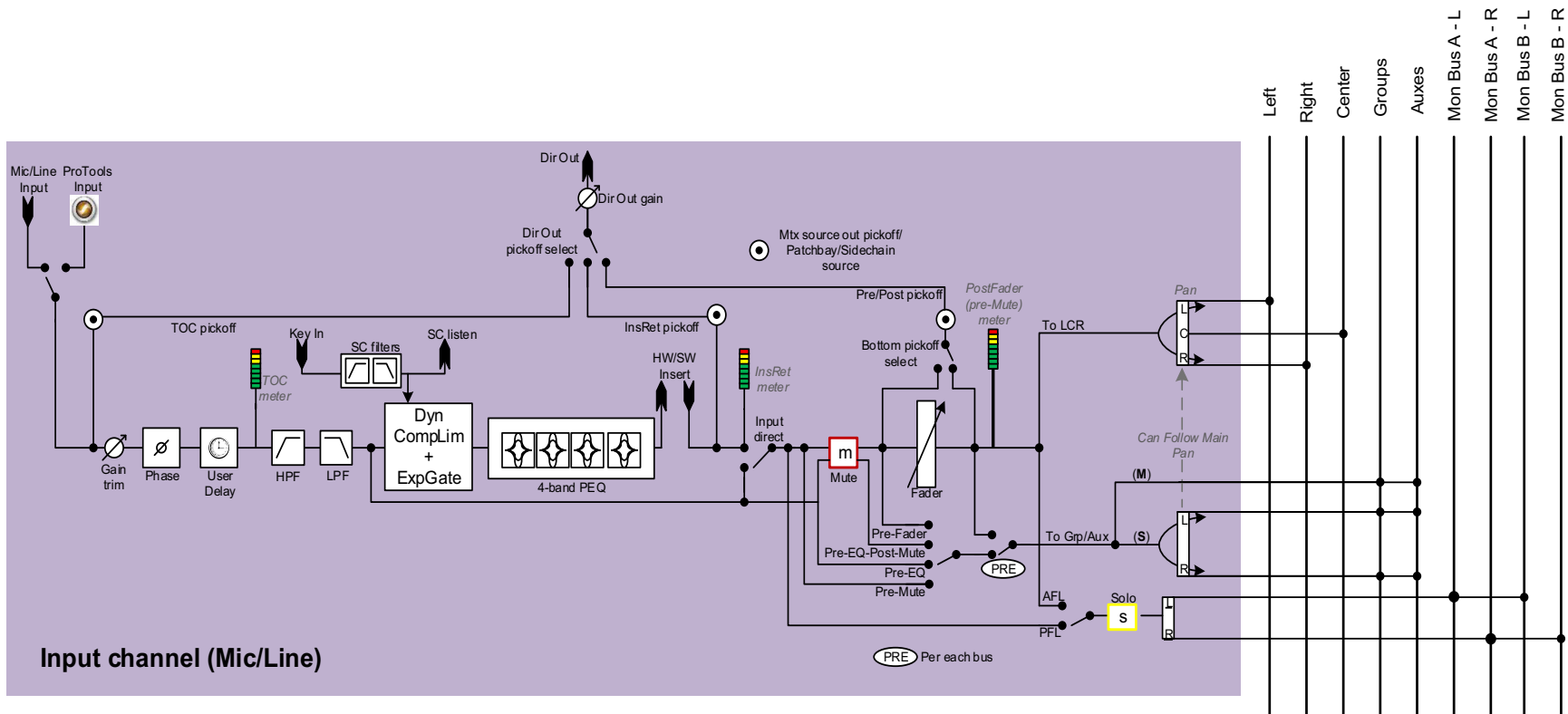

Output Channel Signal Flow

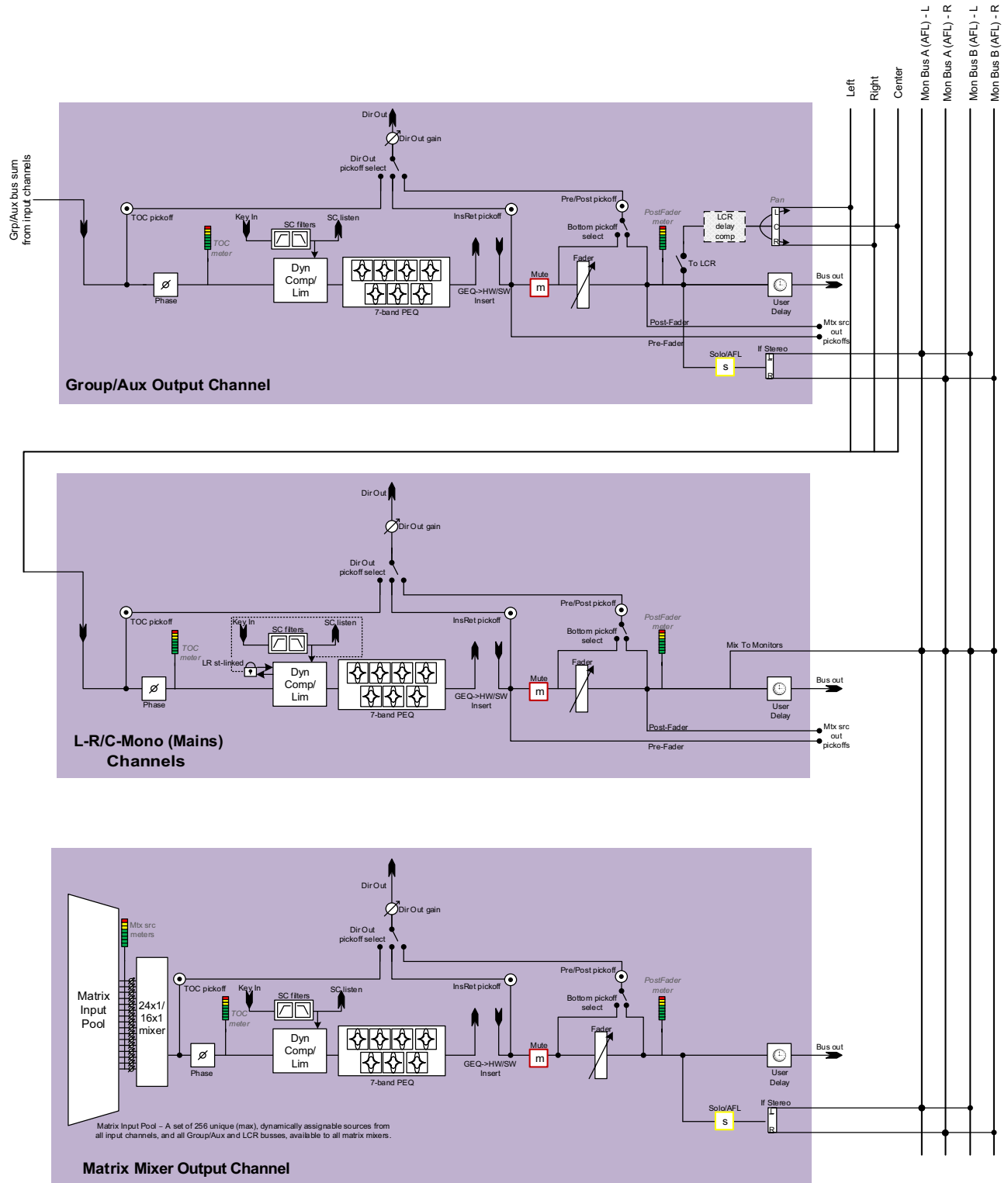

Part VII: Appendices



© Avid Technology, Inc.

Important

(Model: S6L24, S6L32, E6L, and Stage 64)

Environmental Compliance

Disposal of Waste Equipment by Users in the European Union



This symbol on the product or its packaging indicates that this product must not be disposed of with other waste. Instead, it is your responsibility to dispose of your waste equipment by handing it over to a designated collection point for the recycling of waste electrical and electronic equipment. The separate collection and recycling of your waste equipment at the time of disposal will help conserve natural resources and ensure that it is recycled in a manner that protects human health and the environment. For more information about where you can drop off your waste equipment for recycling, please contact your local city recycling office or the dealer from whom you purchased the product.

Proposition 65 Warning

⚠ *This product contains chemicals, including lead, known to the State of California to cause cancer and birth defects or other reproductive harm. Wash hands after handling.*

Perchlorate Notice

This product may contain a lithium coin battery. The State of California requires the following disclosure statement: "Perchlorate Material – special handling may apply, See www.dtsc.ca.gov/hazardous_waste/perchlorate."

Recycling Notice



EMC (Electromagnetic Compliance)

Avid declares that this product complies with the following standards regulating emissions and immunity:

- FCC Part 15 Class B
- EN 55022 Class B
- AS/NZS CISPR 22 Class B
- CISPR 22 Class B
- EN 55103-1, Class E2 and E3
- EN 55103-2, Class E2 and E3
- EN55024

FCC Compliance for United States

Communication Statement

NOTE: This equipment has been tested and found to comply with the limits for a Class B digital device, pursuant to Part 15 of the FCC Rules. These limits are designed to provide reasonable protection against harmful interference in a residential installation. This equipment generates, uses, and can radiate radio frequency energy and, if not installed and used in accordance with the instructions, may cause harmful interference to radio communications. However, there is no guarantee that interference will not occur in a particular installation. If this equipment does cause harmful interference to radio or television reception, which can be determined by turning the equipment off and on, the user is encouraged to try and correct the interference by one or more of the following measures:

- Reorient or locate the receiving antenna.
- Increase the separation between the equipment and receiver.
- Connect the equipment into an outlet on a circuit different from that to which the receiver is connected.
- Consult the dealer or an experienced radio/TV technician for help.

Any modifications to the unit, unless expressly approved by Avid, could void the user's authority to operate the equipment.

Australian Compliance



Canada ICES-003 Compliance

This Class B digital apparatus meets all requirements of the Canadian Interference-Causing Equipment Regulations.

Cet appareil numérique de la classe B respecte toutes les exigences du Règlement sur le matériel brouilleur du Canada.

Korea Class B EMC Compliance

이 기기는 가정용 (B 급) 전자파적합기기로서 주로 가정에서 사용하는 것을 목적으로 하며, 모든 지역에서 사용할 수 있습니다.

CE Compliance

(EMC, Safety and RoHS)



Avid is authorized to apply the CE (Conformite Europeenne) mark on this compliant equipment thereby declaring conformity to EMC Directive 2004/108/EC, Low Voltage Directive 2006/95/EC and RoHS Directive 2011/65/EC.

Index

Numerics

0 dBVU 293
48V 113

A

A Device Has Been Lost 382
A Unit has gone Offline 385
Absolute (editing snapshots) 233
Actions 306

- creating 315
- list 324

ADAT I/O (on the DSI-192 and DSO-192 Digital I/O cards) 358
AFL 162
AND (Event List) 312
Assigning channels to outputs

- external screen 200
- from the control surface 107

Attentioning channels 102

- from the control surface 102, 183
- from the external screen 183

attentioning multiple channels 105
automation

- Automation Safe 258
- see Snapshots

Aux Mon/Aux FX 246
Aux User Presets

- using 249

Auxes

- adjusting Aux Sends 145
- classifying Aux Sends as monitor or FX sends for snapshots 246
- configuring 78
- configuring monitoring options 163
- enabling Sends on Faders mode 163
- Expanded Aux view 146
- spill 89
- User Aux Scope (snapshots) 247
- VCAs Trim Aux Sends in SOF 144

Avid

- address 420
- support resources 13

B

backup

- Show file automatic backup 211
- Show files and settings to a USB drive 208

Balance 194
balance (when pasting) 191
banking

- banking only certain types of channels (Fader Bank Mode) 88
- input channels in split banking mode 86
- Mains 131
- outputs in split banking mode 87
- User Layout 93

banner display 179

Blank Strip 195
bus processing

- adjusting bus-fed plug-ins 126
- assigning a bus-fed plug-in 286
- inserting Graphic EQs 187
- routing a plug-in as a bus processor 288

Busses page 333
bypassing plug-ins 283

C

Cabling

- requirements 12

Cannot assign Stage 64 380
center divergence 334
Center Last Recalled Snapshot 217
channel

- reset shortcut 185

Channel Control

- Channel Control Mode 23
- Function Switches 24
- User assignment 127

channel delay 113
channel EQ

- adjusting using the control surface 118
- adjusting using the external screen 186

Channel Safe Switch/Button

- solo safing using 168

Channel Safe Switches/Buttons

- automation safing using 258
- bank safing using 97
- safing from Recall Safe tab 255
- setting the Channel Safe Switch/Button Safe Mode 344

channels

- copy and paste 191
- in the Patchbay 264
- moving 195, 197

Chase MTC/LTC 216
Child (snapshot) 221
cleaning and maintenance 11
Clear Console

- during reset 332

clip

- Hold 344
- Margin 344

compatibility 12, 351
Config Mode

- and assigning Stage 64s 68, 70
- and loading Shows 205
- and plug-ins 272

Console Connection Error 382
Control (Events) 303
Control surface controls have stopped working 380
Control Surface Module Lost 382
copy and paste

- channel settings 191
- dynamics settings 193

- EQ settings 192
- copying
 - plug-ins 285
- creating an effect send/return 286, 288
- crossfade
 - bypassing 246
- crossfade time (snapshots) 245
- CTM
 - overview 26
 - selecting a channel from 101
 - troubleshooting offline CTMs 385
- cursor 341

D

- Dante (DNT-192 Dante Network Card) 51
- Date & Time Check 382
- dBVU, dBu, dBFS 293
- DC (GPI Output) 376
- Default 29
- delay
 - channel delay 113
 - Delay Compensation 335
 - Monitor bus 165
 - unit display setting 341
- Delay Compensation 335
- Devices page 346
- digital inputs
 - defeating SRC 358
 - DSI-192 Digital Input card 51
 - on the control surface 42
- digital outputs
 - on the control surface 42
 - on the DSO-192 Digital Output card 51
- Digital/Analog EQ 186
- dimensions 393
- Direct Outs
 - adjusting 116
 - patching 267
 - routing to plug-ins 289
- divergence 334
- Dly (channel Delay in snapshots) 261
- DSI-192 Digital Input Card
 - overview 51
- DSI-192 Digital Input card
 - using 358
- DSO-192 Digital Output Card
 - audio specifications 408
 - overview 51
- DSP for plug-ins 292, 346
- dynamics
 - adjusting from the control surface 122
 - adjusting using the external screen 188
 - copying and pasting settings 193
 - sidechain on the CKM 123
 - sidechain on the external screen 189

E

- E6L engine
 - features 5, 46
 - front panel LED codes 402
 - mechanical specifications 397
 - powering on and pairing 62
- Edit (System Config) 329
- Edit mode 233
- Effect Return 126

- Encoder Assign 129
- Engine Internal Switch Warning 382
- EQ

- channel EQ 118, 186
- digital/analog 186
- frequency from CKM 119
- GEQ 187
- settings and presets 192

Events

- actions 306
- and Preview mode 239
- and Snapshot modes 318
- and snapshots 318
- behavior 316
- creating actions 315
- creating triggers 311
- creating, selecting, managing 307
- enabling and disabling 309
- Event List 303
- import 210
- list of action types and properties 324
- list of trigger types and properties 322
- preset files 310
- reset 317
- terminology 302
- testing 317
- triggers 305
- Wait 316
- window 303

- Expanded Aux view 146

F

- Fault LED 402
- feedback
 - avoiding event-created feedback loops 318
- Fiber-Optic
 - cabling requirements 12
 - making connections 405
- Filing
 - History 211
 - loading Shows 205
 - Presets and Scope Sets 206
 - Show files 204
 - Show Folders 203
- Fine 29
 - momentary or latching 29
- Fine mode for encoder parameter adjustment 29
- Flex Channels
 - adjusting Mains on the Flex Channels 130
 - configuring 344
 - overview 33
- Footswitch
 - connector 44
- footswitch
 - Events triggers list 311
 - status display on the external screen 306
- formats (plug-ins) 285
- FX send/return 288

G

- gate
 - adjusting using the control surface 122
 - adjusting using the external screen 188
 - key source 189
 - sidechain filters 124

General Purpose Interface (see GPI)

GPI

- input specifications 375
- output specifications 376
- pulse and duration 316
- status display on the external screen 306
- wiring diagrams 377

Graphic EQ

- adjusting using the control surface 120
- adjusting using the external screen 187

ground (GPI outputs) 376

Group (snapshots) 225

Groups

- assign channels to using the external screen 200
- assigning input channels to using the control surface 109
- configuring 78
- on-screen indication of stereo groups 194
- spill 89

H

hardware inserts 372

Hardware Monitor Alert 382

HDX DSP card requires update 382

headphones

- audio specifications 409
- configuring 170
- jacks 45
- level 170

History 211

History (Show files) 211

HPF 115

I

iLok

- authorizing plug-ins using 276
- secure port for 404

Import

- snapshots and events 210

input and output channels

- adjusting using the control surface 106
- make stereo 194

Input Direct mode 190

Input Safe Switches

- changing modes via an Event 320

inputs

- 20 dB pad 113
- assigning to Mains and Groups 107
- banking 86
- HPF 115
- Input Direct mode 190
- LPF 115
- pan 114
- phantom power 113
- polarity (phase) 116
- width 114

Insert Blank Strip 195

inserting external hardware on channels 372

inserts

- assigning plug-ins 286
- hardware inserts 372

installing

- plug-ins 273
- System Restore software 388

Interaction page 342

K

key assign 189

key listen 124, 190

key source 189

L

Latch (Event action behavior) 316

latching Solo on 166

latching to a Flex Channel 33

levels

plug-ins 293

listen wedge 165

locking snapshots 230

logic (GPI) 375

LPF 115

LTC

supported frame rates 363

M

MADI

MADI Outs, Stage 64 59

Mains 334

banking 131

configuring 77

configuring Main busses 77

input routing 107

Make Mono 194

Make Stereo 194

and Blank Strips 195

Master Live Module (MLM)

overview 28

Matrix

adjusting input (send) levels 149

linking and unlinking inputs 150

make a stereo Matrix 194

spill 89

mechanical specifications 393

Media (see Events) 303

Media Clock Master 355

metering

ballistics for meters 343

meter options 343

Meters view

selecting a channel from 101

MIDI

adding to snapshots 240

in Preview mode 239

MIDI Snapshot Output Safe 253

output Safe 242

triggering external devices on snapshot recall 366

Misc page 338

Mix (Recall Safe parameters) 256

Mix Busses

configuring Auxes and Groups 78

Momentary (snapshots) 224

momentary Solo 166

Monitor

assignable output 165

Delay 165

level 170

mouse settings 341

move input channels

Move Selected Strip Here right-click command 195

using drag and drop 197

moving plug-ins 285

MTC

- generating MTC from VENUE (sending MTC to an external device) 362
- in Preview mode 239
- supported frame rates
 - MTC/LTC
 - supported frame rates 363

MTC/LTC

- chase 216
- Events and Preview mode 239

MTS

- attentioning channels from 102
- basics of using 37
- Multi-Assign 107
- overview 37
- selecting a channel from 101
- troubleshooting 390

Multi-Assign

- from the MTS 107

Multi-Select 104

- on the external screen 183
- using Attention 105
- using Select 104

Mute

- channel strip Mute switch 18
- Mute Groups 156
- Mute Groups tab 156
- muting from the MTS 155
- with VCAs 161

N

near field monitors

- patching 165

Network ports

- E6L engine 49
- S6L control surface 43
- Sig and Act LEDs 403
- Stage 64 53

Notes

- Show files 211
- Snapshots 220

O

offset 112

One or more Engine fans have stopped working 382

One or More Units have Failed 382

operating modes (Config Mode and Show Mode) 67

Options 329

- Busses 333
- Devices 346
- Interaction 342
- Misc 338
- Pickoffs 335
- Snapshots 336

options 343

OR (Event List) 312

Other 285

outputs

- banking in split banking mode 87
- divergence 334
- graphic EQ 187
- patching/routing 266
- reassigning in Patchbay 270
- routing 267

P

pad 113

padlock (snapshots) 230

Pan 114

- see also Width 114

pan

- divergence 334
- when pasting 191

parameters 153, 161

Parent (snapshot) 221

Patchbay

- displays and indicators 264
- navigating 264
- overview 262
- warning when reassigning 270

Patching Grid 263

Peak mode (metering) 343

PEQ 118, 186

PFL 162

phantom power 113

Pickoffs page 335

Plug-In Racks are Ready 388

Plug-In Racks Need Reset 382, 388

plug-ins 272

- adjusting bus fed plug-ins (effect returns) using the control surface 126

- adjusting inserts using the control surface 125

- and channel Direct Outs 289

- and snapshots 291, 292

- assigning to rack slots 284

- Config and Show mode 272

- display unavailable and inactive 282

- DSP available 292, 346

- enabling and disabling 276

- in Preview mode 238

- in/out (bypass) 283

- indication of targeted plug-in in rack slot 281

- list and menu management 276

- managing 274

- mono, stereo, other 285

- moving and copying 285

- pinning a view 281

- preset files 291

- rack slots 283

- racks 278

- re-initializing the racks 388

- routing to and from 286

- snapshot indication (red) 282

- Use Racks 388

- views 278

- Waves 295

Plug-ins to Install 273

polarity (input) 116

Position Safe when Spilling 342

power

- replacing control surface and engine PSUs 403

- requirements 12

- start up/shut down guidelines 62

Power supplies (PSUs)

- E6L engine PSU description 49

- replacing 403

- requirements 12

- S6L control surface PSU description 44

Pre (snapshot parameters) 246

Presets

- and plug-ins 291
- presets
 - Aux User Scope 249
 - EQ 192
 - Events 310
 - folders 206
 - managing 207
 - plug-ins 291
 - Scope Sets 257
 - transferring 208
- Preview mode 30, 236
 - and plug-ins 238
 - and Undo 237
 - capabilities and overview 237
 - MIDI and MTC 239
- Propagate mode 234
- Pulse and Duration (GPI) 316
- Push-Pin (plug-in view) 281

Q

- Quit 63

R

- rack slots 278
- racks 388
- racks (plug-ins) 278
- Recall 226
 - Next 215
 - Previous 215
- Recall Safe
 - and Preview mode 237
 - Channel Safe 255
 - Matrix and PQ 256
 - using 255
- red plug-in rack 282
- Redundant Connection Lost 382
- Relative (editing snapshots) 233
- Reset 388
- Reset (strip) 185
- reset a section or parameter 29
- resolution (see Fine)
- Restoring the system software 388
- restoring your system 388
- RMS mode (metering) 343
- routing
 - Monitor bus 165
 - multiple channels to a hardware output 269

S

- S6L control surface
 - banking channels 84
 - features 2
 - hardware I/O 42
 - I/O audio specs 406
 - secure USB port for iLok 404
 - selecting and attentioning channels 100
 - troubleshooting control surface I/O 385
- S6L control surface I/O is not passing audio 380
- Safe
 - Automation Safe 258
 - enabling in Channel Control mode 117
 - solo safe 168
- Sample Rate Conversion
 - Alert 382

- for digital inputs 358
- save (History auto-save) 211
- Scope Sets
 - transferring 208
 - using 257
- Selecting channels 100
- selecting multiple channels 104
- Sends on Faders mode
 - enabling 163
 - using 141
- settings
 - EQ 192
 - plug-ins 291
- SFP transceiver modules
 - qualified modules 12
- Shared Stage inputs
 - Working with outputs 127
- shortcuts
 - Snapshots 216
- Show files 203
 - creating 203
 - deleting 204
 - Folders 204
 - loading 205
 - transferring 208
- Show Folder 204
- Show Mode 67
- Shows
 - and plug-in management while loading 276
- shut down 63
- side-chain
 - assigning for plug-ins 289
 - assigning source (gate only) 189
- sidechain
 - adjusting from the CKM 123
 - adjusting from the external screen 189
- SIP 162
- Snapshots
 - adding MIDI messages 240
 - adding plug-in data 242
 - Center Last Recalled in list 217
 - Channel Safe 255
 - channel scope 218
 - chase MTC/LTC 216
 - classifying Aux Sends for snapshot recall 246
 - creating 220
 - crossfade time 245
 - data type buttons 218
 - Edit mode 233
 - Events and Preview mode 239
 - faders 219
 - Group 225
 - import 210
 - in Preview mode 237
 - keyboard shortcuts 216
 - List 215
 - list of data types and parameters 256, 261
 - locking and unlocking 230
 - managing (storing, clearing, deleting, moving, duplicating) 230
 - MIDI and plug-ins in Preview mode 237
 - Momentary 224
 - naming and renaming 220
 - notes 220
 - overview 213

- Parent and Child 221
- plug-in menu 292
- plug-in scope indication 282
- Preview (editing and previewing snapshots) 30, 236
- Propagate mode (updating snapshot parameters) 234
- recalling 226
- safe filter (Recall Safe) 255
- Scope Sets 249, 257
- selecting 216
- snapshot color indication in Snapshots List 215
- target 226
- User Aux Scope 248
- x-Fade 245

- Snapshots page 336
- software

- overview of pages and tabs 175

- Solo 168

- AFL, PFL, SIP modes 162
 - and key listen 124, 190
 - momentary and latching modes 166

- Solo and monitor options

- configuring 162

- Solo Safe 168

- Soundgrid 295

- Spill mode 89

- Stage 16

- about 8
 - configuring 79

- Stage 32

- about 7

- Stage 64

- Confidence Monitor 55
 - features 6
 - front panel LED codes 402
 - Identify and Mute switches 348
 - mechanical specifications 398, 399, 400, 401
 - reassigning 79
 - troubleshooting Stage 64 I/O 385

- Status LED 402

- stealing channels in the Patchbay 270

- stereo

- spread (Bal/Width) 194

- stereo channels (see Make Stereo) 194

- stereo effect return 194

- stereo plug-ins 285

- support resources 13

- System Config 329

- System LED 402

- system requirements 12, 351

- System Restore 388

- System Restore Software 388

- System Test 332

T

- Tap Tempo

- event 327
 - in Snapshots 244
 - switch 36
 - using 294

- temperature

- monitoring component temperatures 347
 - operational requirements 11

- The 13, 162

- Time Code Options 337

- Touch on external screen is reversed with MTS, or not operating at all 380

- Trackball

- settings for 341

- transfer 208

- triggering external devices with MIDI 366

- Triggers 305

- creating 311

- list 322

- Troubleshooting

- Restoring the system software 388

- troubleshooting

- plug-ins 276

- restoring your system 388

U

- Undo

- in Preview mode 237

- via History 211

- Unsupported HDX DSP configuration detected 382

- USB ports

- E6L engine front-panel ports 47

- S6L control surface front-panel ports 45

- secure internal port for plug-ins iLok 404

- Use Racks 388

- User Aux Scope 247

- using 248

- User Layout 90

- Utility mode 387

V

- VCA's

- and snapshots 261

- assigning 134

- VCA's Trim Aux Sends in SOF 144

W

- Wait (Event List) 316

- Warning Dialogs 382

- Waves 295

- While Active (Event action behavior) 316

- Width 114

- width (when pasting) 191

- Word Clock

- I/O 49, 53

- indication of 355

- synchronizing with 353, 359

- WSG-HD card 295

X

- X-fade (crossfade) 245

- XOR (Event List) 312



Avid
75 Network Drive
Burlington, MA 01803

Technical Support (USA)
Visit the Online Support Center
at www.avid.com/support

Product Information
For company and product information,
visit us on the web at www.avid.com