

# Dan Dugan Sound Design

## Model E-2 Automatic Mixing Controller

### User Guide

Release Date: August 2013

Version: 1.0

Author: Rob Wenig

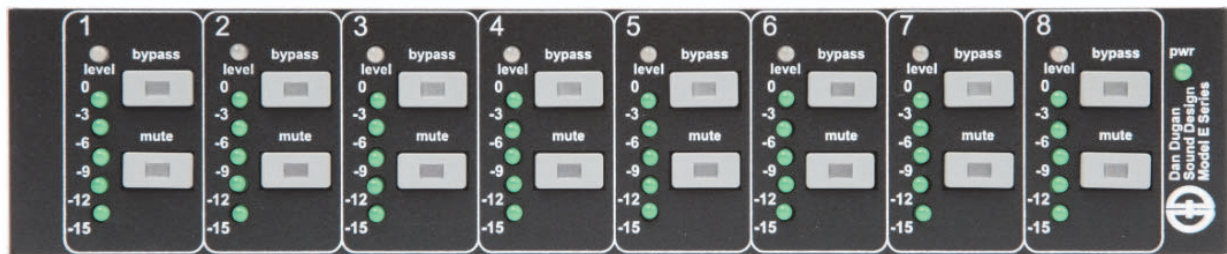

Dan Dugan Sound Design



290 Napoleon St., San Francisco, CA 94124  
Phone: (415) 821-9776 Fax: (415) 826-7699

---

# Important Safety Instructions and Warnings

The Model E-2's circuitry is made in the USA and meets applicable national safety standards.

## Standards Compliance

The third-party power supply provided with this product has been certified to comply with UL.

## Safety Instructions

1. Read these instructions.
  2. Keep these instructions.
  3. Heed all warnings.
  4. Follow all instructions.
  5. Do not use this apparatus near water.
  6. **WARNING!** To reduce the risk of fire or electric shock, do not expose this apparatus to rain or moisture.
  7. Clean only with dry cloth.
  8. Do not block any ventilation openings. Install in accordance with the manufacturer's instructions.
  9. Do not install near any heat sources such as radiators, heat registers, stoves, or other apparatus (including amplifiers) that produce heat.
  10. Do not defeat the safety purpose of the polarized or grounding-type plug. A polarized plug has two blades with one wider than the other. A grounding type plug has two blades and a third grounding prong. The wide blade or the third prong are provided for your safety. If the provided plug does not fit into your outlet, consult an electrician for replacement of the obsolete outlet.
  11. Protect the power cord from being walked on or pinched particularly at plugs, convenience receptacles, and the point where they exit from the apparatus.
  12. Only use attachments/accessories specified by the manufacturer.
  13. Unplug this apparatus during lightning storms or when unused for long periods of time.
  14. **WARNING!** Refer all servicing to qualified service personnel. Servicing is required when the apparatus has been damaged in any way, such as power-supply cord or plug is damaged, liquid has been spilled or objects have fallen into the apparatus, the apparatus has been exposed to rain or moisture, does not operate normally, or has been dropped.
  15. **WARNING!** To reduce the risk of electric shock, DO NOT REMOVE COVER. No user serviceable parts inside.
-

---

# Warranty Statement

Warranty: One year parts and labor

Dan Dugan Sound Design warrants that Model E-2 hardware will be free from defects in components and workmanship for a period of 12 months from the date of invoice. During the warranty period, Dan Dugan Sound Design will cover the cost of all parts and labor to remedy the defect, or replace products which prove to be defective. Dan Dugan Sound Design is not obliged to honor this warranty if the hardware has failed to be maintained and operated as specified by Dan Dugan Sound Design, in the accompanying documentation, or other than in accordance with industry standards. Defects caused by unauthorized modifications, misuse, negligence, act of God or accident are not covered by this warranty. Software is provided as a convenience, but due to the wide variety of computer systems, cannot be guaranteed to work. This Limited Warranty is exclusive and no other warranty is expressed or implied. Dan Dugan Sound Design does not warrant that Dan Dugan Sound Design software, or any third-party software, is error free. Third party branded or manufactured goods are supplied by Dan Dugan Sound Design with care but without responsibility and subject only to third party suppliers' warranties. In all other respects Dan Dugan Sound Design is not liable for consequential damages.

---



# Table of Contents

<b>Chapter 1: Introduction</b> .....	9
Dugan Speech System Theory.....	10
Dugan Music System and Gain Limiting Theory.....	11
Model E-2 Modes.....	13
Eight-channel.....	13
Twelve-channel.....	13
Sixteen-channel .....	13
<b>Chapter 2: Quickstart</b> .....	15
<b>Chapter 3: Installation and Configuration</b> .....	17
Rack Mounting .....	17
Power Supply .....	18
System Reset.....	18
Rear Panel I/O Connections.....	19
Analog .....	20
Digital .....	21
Music System Threshold Inputs .....	21
Linking.....	22
Patching the Model E-2 as an Insert to your Console .....	22
Unprocessed Outputs .....	22
Mix Matrix Outputs .....	23
Connecting the Model CP-2 Control Panel.....	23
Connecting to a Computer .....	24

<b>Chapter 4: Stand-alone Operation</b> .....	31
Settings.....	31
If You Must Use a Pre-fader Insert .....	33
Muting Channels.....	33
Pre-listening to Muted Channels .....	34
<b>Chapter 5: Dugan Control Panel Software</b> .....	35
The Top Pane.....	37
Adding Units Manually .....	37
Selecting Units to Display .....	38
Setting Controls.....	38
Naming Units and Channels.....	39
Channel Pane .....	39
Level Indicator.....	40
Bypass .....	40
Channel Modes.....	41
Preset .....	42
Channel Groups.....	42
Override.....	43
Meters .....	43
Weight Controls .....	44
Master Pane.....	46
Selecting the Number of Channels .....	47
Reset .....	48
Meters .....	48
System.....	48
Mix Bus Matrix.....	49
Group Master Controls .....	50

Dugan Music System and Gain Limiting.....	51
Dugan Music System .....	51
Gain Limiting .....	54
<b>Chapter 6: Updates</b> .....	<b>57</b>
<b>Appendix A: Power-up Commands</b> .....	<b>59</b>
System Reset .....	59
Network Reset.....	59
DHCP On.....	59
Number of Channels Mode .....	60
<b>Appendix B: Connector Pinouts</b> .....	<b>61</b>
<b>Appendix C: Specifications</b> .....	<b>65</b>





## Chapter 1: Introduction

---

The Model E-2 Automatic Mixing Controller helps professional audio mixers handle multiple live mics without having to continually ride their individual faders. This signal processor patches into the input insert points of an audio mixing console. It detects which mics are being used and makes fast, transparent cross-fades, freeing the mixer to focus on balance and sound quality instead of being chained to the faders. The Model E-2 tracks unscripted dialogue, eliminating cueing mistakes and late fade-ups, while avoiding the choppy and distracting effects common to noise gates.

The Model E-2 supports a broad spectrum of live mixing applications:

- Conference reinforcement, video trucks
- Houses of worship
- TV news and sports panels, reality and game shows
- Wireless mics for theater
- Boardrooms and civic meeting rooms
- Teleconferencing and distance learning

The Model E-2 dramatically improves live mixing with multiple mics by:

- eliminating late upcuts;
- reducing PA feedback and studio noise;
- reducing comb filtering from adjacent mics.

The Model E-2 can:

- be physically controlled from its own front panel, or the Model CP-2 Control Panel (sold separately);
- be remote controlled from the Dugan Control Panel for Java (included) and Dugan Control Panel for iPad (sold separately);
- conveniently connect multiple devices via four network ports;
- link with other Dugan automatic mixing controllers to create a larger system;
- partition channels into one to three groups that can span linked units;
- create separate linked systems that do not interact (i.e., for separate studios).

## Dugan Speech System Theory

The Dugan Model E-2 Automatic Mixing Controller uses the Dugan Speech System™, a patented and trademarked automatic mixing function. The Dugan Speech System distributes the gain of one open microphone over the entire system, maintaining a natural one-mic ambience. It is essential to distinguish this behavior from the annoying fluctuation of levels and uneven ambience in a conventional gating system.

The system automatically manages any number of live mics in unpredictable dialogue situations. When one person speaks, that mic's gain fades up instantly, and the others down. When the speaker pauses, all mics fade to medium gains that sum to equal one mic at full gain. The result sounds like passing one mic around among the speakers. When several people talk at once, the gain is shared.

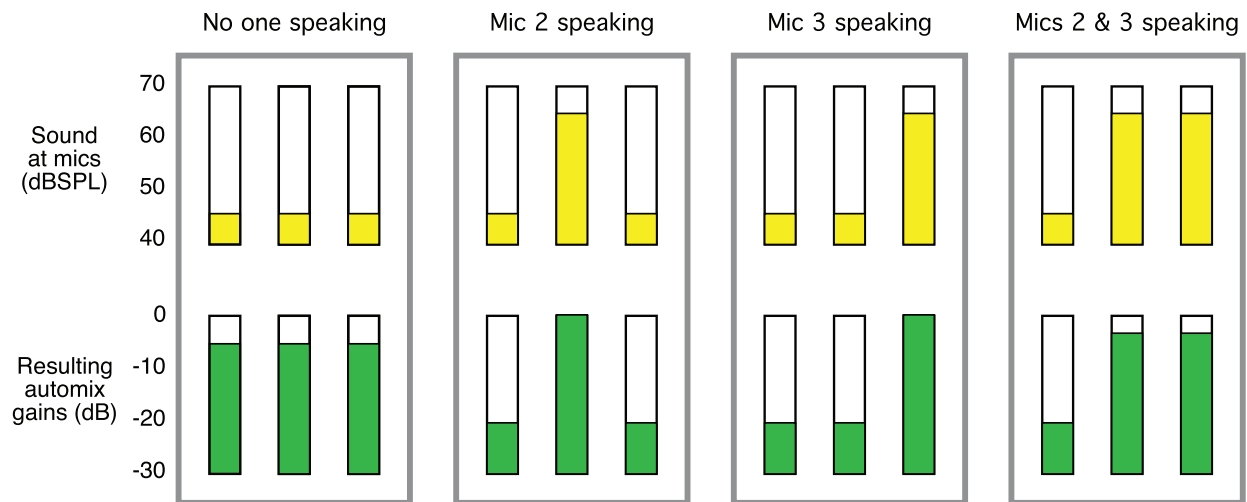

**Figure 1-1** Four snapshots of a three-mic system

Figure 1-1 shows the Speech System in action with a three-mic system.

- The first frame shows no one speaking; the sound levels at all mics are low. The system fades all channels to medium gains that sum to the equivalent of one mic at full gain.
- The second frame shows one person speaking. The system automatically fades his/her gain to full, while the other two inputs are turned down.
- The third frame shows a different person speaking. The system automatically fades his/her gain to full, while the other two inputs are turned down.
- The fourth frame shows two people speaking simultaneously. The system automatically shares the gain between them, while the other input is turned down.

## Dugan Music System and Gain Limiting Theory

These functions require the physical Model CP-2 or Dugan Control Panels for Java or iPad. See *Dugan Music System and Gain Limiting* on page 51 for more information on setting up the Music System.

### Dugan Music System

The Dugan Music System is a soft-gating or ducking system with its threshold set by an audio side-chain, typically from a mic measuring the ambient sound level. Each channel has a 2:1 expansion ratio below the floating threshold. There are three Music System Threshold inputs on the **AUDIO I/O 9-12** connector (channels 9-11), one for each group.

The Music System can also be used to duck an audience mix when the people on stage talk, attenuating the sound of the PA in the room. Use an aux send of the stage vocal mix to supply the threshold signal instead of a mic.

The following example (Figure 1-2) shows how the Music System works with three background vocalists.

- Frame 1 shows no one singing. The system keeps all channels at a low gain.
- Frame 2 shows one person singing. The system automatically fades his/her gain to full, while the other two inputs stay low.

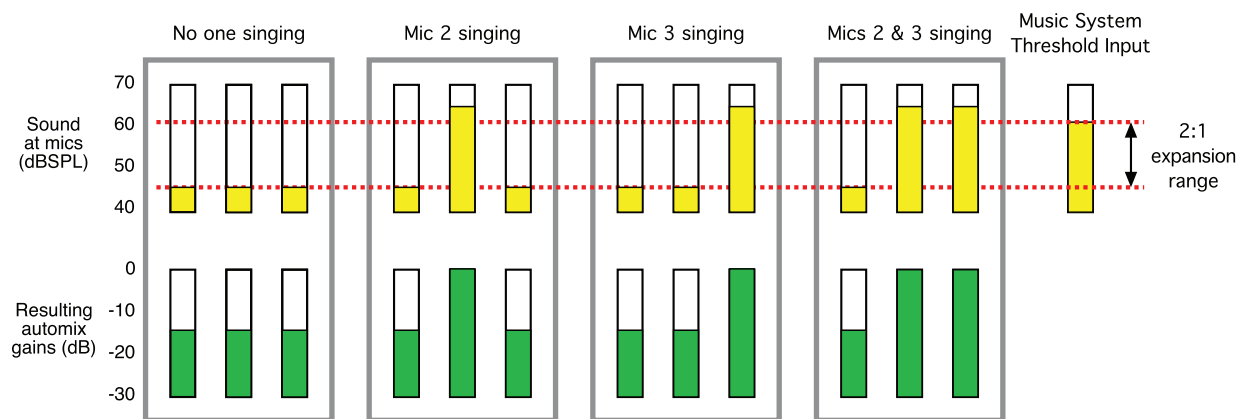

**Figure 1-2** Function of the Dugan Music System

- Frame 3 shows a different person singing. The system automatically fades his/her gain to full, while the previous singer's mic and the other input stay low.
- Frame 4 shows two people singing together. The system automatically gives their channels full gain, while the other input stays low.

## Gain Limiting

Gain Limiting reduces master gain as new mics enter the system, thus avoiding feedback and noise. This is commonly called NOM (Number of Open Mics) gain adjustment. Unlike NOM functions on other systems, Dugan Gain Limiting doesn't just count how many mics are on. It sums the gains of all active channels (including partially attenuated channels), compares them to a gain threshold, and reduces the gain appropriately.

Conventional automatic mixing implementations always assume an NOM of 1.

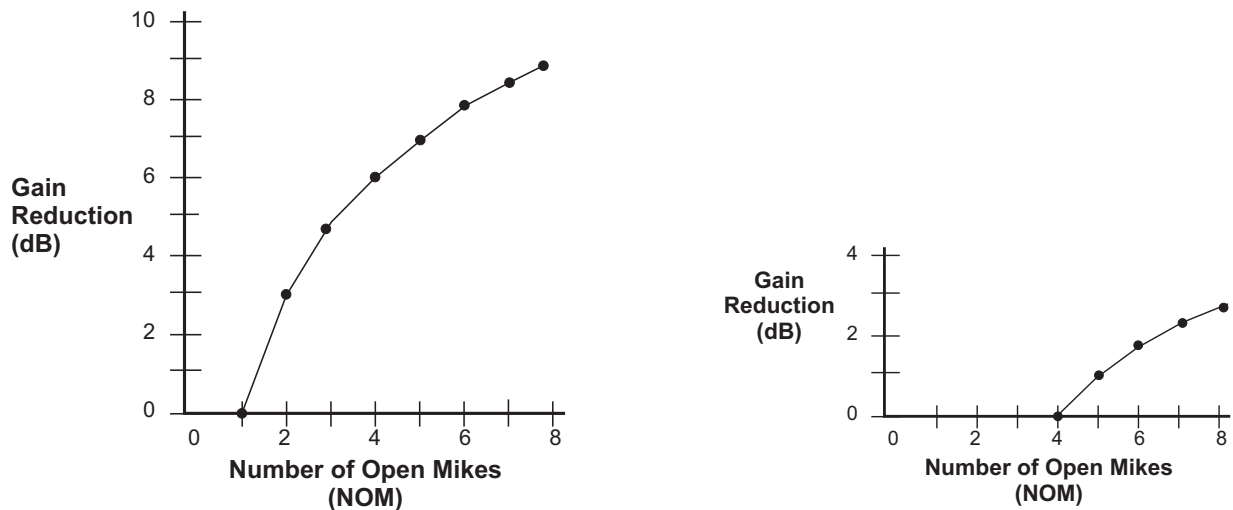

**Figure 1-3** NOM and gain reduction: NOM =1 (left); NOM = 4 (right)

The Dugan's unique implementation allows you to set the number of mics at full gain before gain limiting occurs.

For example, if there is enough gain before feedback to tolerate four open mics, the gain limit can be set to 4. Gain reduction begins when the fifth mic turns on.

## Model E-2 Modes

The Model E-2 is an eight-channel audio processor offering three Dugan algorithms. However, it can operate in twelve- or sixteen-channel modes with reduced features.

See Chapter 3: *Installation and Configuration* to learn how to choose a mode with the **#ch** button during installation.

### Eight-channel

- The Dugan Speech System™ provides automatic mixing for eight live mics.
- The Dugan Music System™ offers automatic downward expansion to help reduce feedback and bleed in live music performances (i.e., opera, background vocals). Thresholds are adjusted automatically by monitoring ambient noise levels.
- Dugan Gain Limiting™ monitors the number-of-open-mics (NOM) and adjusts the master gain to prevent feedback or ambient noise build-up. Dugan Gain Limiting should be used with the Dugan Music System to reduce feedback and noise. It can perform the same functions when mics are switched on and off manually.
- Linking creates one large automatic mixing system with multiple Dugan units.
- An internal mix bus matrix routes processed or unprocessed inputs to four mix bus outputs.
- Unprocessed outputs are provided: analog inputs are mirrored at the digital output, and vice versa. This provides convenient pre-processing signals for multitrack recording.

### Twelve-channel

- The Dugan Speech System™ provides automatic mixing for twelve live mics.
- Linking creates one large automatic mixing system with multiple Dugan units.

### Sixteen-channel

- The Dugan Speech System™ provides automatic mixing for sixteen live mics. This is a digital connection that uses both the **AUD** and **LINK** ADAT optical connectors.



## Chapter 2: Quickstart

This section provides step-by-step instructions to help you get started quickly using the Dugan Speech System to mix up to eight channels. Twelve- and sixteen-channel I/O is available using the Dugan Control Panel software. See Chapter 5: *Dugan Control Panel Software* to learn about these options.

1. Connect the provided power supply to the Model E-2.
2. Hold the channel 1 **bypass** button down and power up the unit. Keep holding the **bypass** button down for three seconds until the unit finishes booting.

This System Reset command sets all parameters to factory default settings and clears label text.

We recommend executing a System Reset before starting a new installation. This is just like zeroing a console before a show.

3. Set the **NORM-SLAVE** switch on the rear panel to **NORM** (up) for unlinked operation. The Model E-2 can be interfaced using balanced analog or digital optical connectors:
4. **Analog:** Move the **ANA-DIGI** switch on the rear panel to the **ANA** (up) position. The DB25 connectors carry balanced analog signals. Each connector provides four inputs and four outputs.



Figure 2-1 Model E-2 rear panel

**Digital:** Move the **ANA-DIGI** switch on the rear panel to the **DIGI** (down) position, connect the console ADAT output to **AUD IN**, and connect **AUD OUT** to the console's ADAT input.

5. Whenever possible, route each Model E-2 channel as a post-fader, pre-compressor insert to each mic channel.

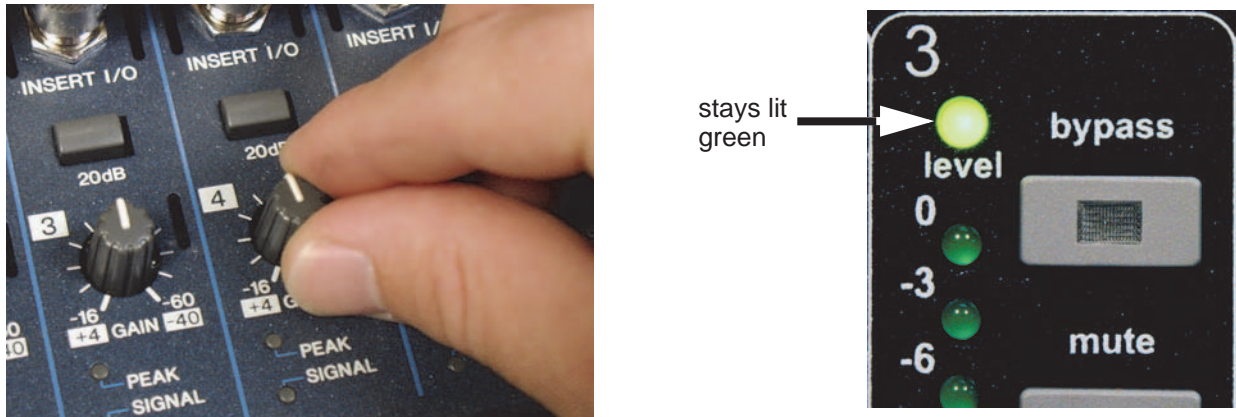

Figure 2-2 Setting console preamp gain

6. With the room quiet, raise your console preamp gains until the Model E-2's green level LEDs stay illuminated.

The level LED illuminates green when the input level is within the acceptable range for automatic mixing and flashes red to indicate clipping. There should be enough gain ahead of the Model E-2 to maintain the green LED at all times.

**NOTE:** When the green level light extinguishes, the channel is in a downward expansion mode to avoid feedback. This condition should be avoided because the smooth ambience that characterizes Dugan automatic mic mixing is lost.

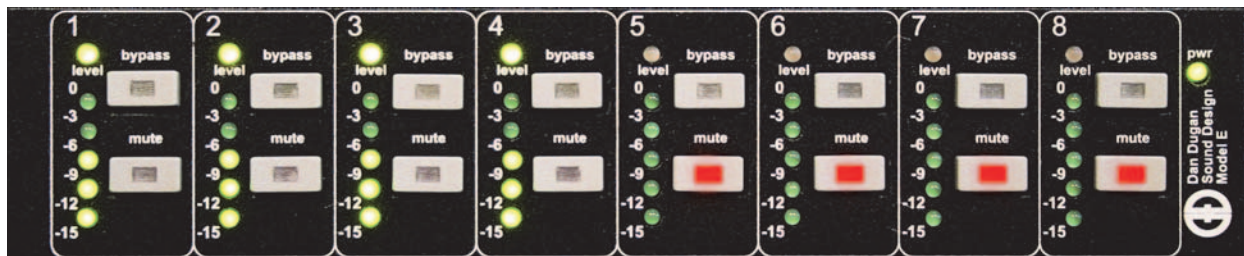

Figure 2-3 During ambience with 4 mics, auto mix gain displays should hover around -6 dB

7. Adjust your console's preamp gains so all LED meters float at about the same gain when no one is talking. This procedure assures smooth automatic mixing.



---

## Chapter 3: Installation and Configuration

---

We recommend placing the Model E-2 in a convenient place in the engineer's line of sight.

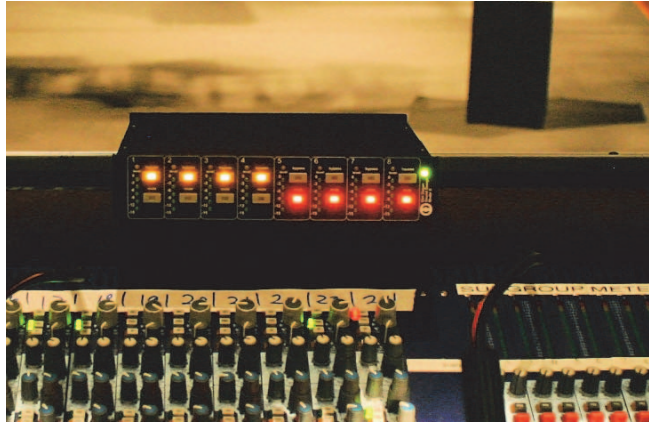

**Figure 3-1** Model E-2 placed conveniently

### Rack Mounting

All E-Series Dugan controllers are a half-rack wide, so one or two can be mounted in a single rack space. Each unit ships with one long and one short rack ear and one joining plate.

The rack ears for older E-Series Dugans differ slightly from the current design, but the joining plates are the same. All E-Series Dugans can be mounted side-by-side using the appropriate rack ear for each unit.

To mount one unit: Attach one long and one short rack ear, then mount in the rack.

To mount two units side-by-side:

1. For the left unit, remove the four screws from the right side of the top and bottom lids.
2. Attach the top and bottom joining plates to the left unit.
3. For the right unit, remove the four screws from the left side of the top and bottom lids.
4. Attach the top and bottom joining plates to the right unit.
5. Attach the appropriate rack ears to the left and right units.
6. Mount the pair in the rack.

## Power Supply

Units shipped to the USA include a 12 V, 1.5 A, 120 VAC power supply. Contact the factory if you require a different power supply. In an emergency, the Model E-2 can accept power supplies within the following ranges:

- 12–24 VDC, either polarity, 1.5 A
- 9–18 VAC, 1.5 A

## System Reset

Hold down the channel 1 **bypass** button and power up the unit. Keep holding the **bypass** button down for about three seconds until the unit finishes booting.

This System Reset command restores all parameters to factory default settings and clears label text. This is just like *zeroing* a console before a show. We recommend executing a System Reset before starting a new installation.

The Model E-2 can execute four other power-up commands (see Appendix A: *Power-up Commands*).

---

**NOTE:** *If for any reason you cannot connect to a computer, power-up commands can establish essential settings.*

---

## Rear Panel I/O Connections

The Model E-2 provides the following rear panel I/O connectors:

- **AUDIO I/O 1-4**
- **AUDIO I/O 5-8**
- **AUDIO I/O 9-12**

Each DB25 connector carries four input and four output analog channels. All analog audio connections are balanced.

To connect with XLR connectors, use readily available adapter squids. Although the Model E-2 uses these connectors for analog I/O, they are wired according to the TASCAM digital standard.

- **AUD IN, AUD OUT**

These ADAT connectors carry eight audio I/O channels.

- **LINK IN, LINK OUT**

These ADAT connectors carry proprietary linking data. They can also be re-assigned as eight additional audio channels.

- **CP-2 CONTROL PANEL**

This carries RS422 data to and from the Model CP-2 Control Panel.



**Figure 3-2** Model E-2 rear panel I/O connectors

## Analog

Move the **ANA-DIGI** switch to **ANA** (up position).

If you do not need the Dugan Music System, twelve channels of automixing are available using all three DB25 connectors.

The content of the **AUDIO I/O 9-12** DB25 connector depends on the state of the **#ch** switch. This can be set in the Dugan Control Panel (see Chapter 4: *Dugan Control Panel*) or with a power-up command (see Appendix A: *Power-up Commands*).

### +4/-10

This sets the input sensitivity, internal headroom, and output level between professional (+4) and consumer (-10) audio line levels.

### 8-Ch

- Eight automix channels on the **AUDIO I/O 1-4** and **AUDIO I/O 5-8** DB25 connectors
- Three Music System threshold inputs on the **AUDIO I/O 9-12** (channels 9-11)  
Channel 12 is an auxiliary input sent to the mix bus matrix.
- Four mix bus outputs on **AUDIO I/O 9-12** (channels 9-12)
- Linking available on **LINK IN, LINK OUT**
- Unprocessed outputs are available on **AUD OUT**

---

**NOTE:** *Since relays route the audio input signals for channels 1-12 directly to their respective outputs when the unit is off, you can leave it patched when not in use.*

---

### 12-Ch

- Twelve automix channels on all three DB25 connectors
- Linking available on **LINK IN, LINK OUT**
- Music System and mix buses not available

## Digital

Move the **ANA-DIGI** switch to the **DIGI** (down) position. This switches the I/O to the ADAT connectors.

The state of the **#ch** switch determines the I/O count and linking capability. This can be set in the Dugan Control Panel (see Chapter 4: *Dugan Control Panel*) or with a power-up command (see Appendix A: *Power-up Commands*).

### 8-Ch

- Channels 1–8 on **AUD IN/AUD OUT**
- Linking and Music System available  
The Music System threshold inputs are still input as analog signals on **AUDIO I/O 9–12** (channels 9–11).
- Mix bus outputs available on **AUDIO I/O 9–12** (channels 9–12)
- Unprocessed outputs are available on **AUDIO I/O 1–4** and **AUDIO I/O 5–8**

### 16-Ch

- Channels 1–8 on **AUD IN/AUD OUT**
- Channels 9–16 on **LINK IN/LINK OUT**
- Dugan Music System, input splits, mix bus outputs, and linking not supported

## Music System Threshold Inputs

A Music System threshold signal can be provided as a reference for each group. When the levels of channels in the group exceed the level of the Music System threshold signal, the channels come up to full gain.

The sensing mics are typically input to the same console as the program mics, but are routed to direct outputs or sends, not mix buses.

The **AUDIO I/O 9–12** DB25 connector can receive three Music System threshold inputs, one for each group (a, b, c on channels 9, 10, 11).

## Linking

Up to eight Dugan units can be linked into a single automatic mixing system. The audio I/O for each must be configured and connected individually. Linking passes only control information between Dugans, not audio.

One unit must be set to be the master and the others slaves.

1. Designate one unit as the master by setting the **NORM-SLAVE** switch on the rear panel to **NORM** (up).
2. Designate any other units as slaves by setting their **NORM-SLAVE** switches on the rear panel to **SLAVE** (down).
3. Use ADAT (Toslink) cables to link units in a ring network (see above).  
Note that all **LINK IN** and **OUT** connectors are used to create the ring.

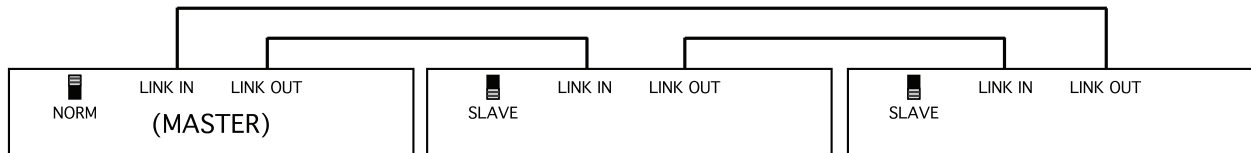

Figure 3-3 Linking Dugan units

## Patching the Model E-2 as an Insert to your Console

The best place to insert the

- Dugan Speech System channels is post-EQ, post-fader, pre-compressor;
- Dugan Music System channels is post-EQ, pre-fader, pre-compressor.

## Unprocessed Outputs

When using the **ANA** setting, the ADAT **AUD OUT** connector can send unprocessed signals (channels 1–8) to a multitrack recorder.

When using the **DIGI** setting, the **AUDIO I/O 1–4** and **AUDIO I/O 5–8** connectors can send unprocessed signals (channels 1–8) to a multitrack recorder.

## Mix Matrix Outputs

In eight-channel mode, an internal mix matrix can route processed or unprocessed inputs to four mix bus outputs on the **AUDIO I/O 9–12** connector.

For more information on using mix buses, see *Mix Bus Matrix* on page 49.

## Connecting the Model CP-2 Control Panel

The Dugan Model CP-2 Control Panel hardware can be connected to the four-pin mini-XLR connector. When a CP-2 is connected, the channel **weight** and master **NOM gain limit**, **music system threshold**, and **automix depth** values can be set only on the CP-2 and are read-only on the Dugan Control Panels for Java and iPad.



Figure 3-4 Model CP-2 Control Panel

## Connecting to a Computer

Two Java applets are provided with the Model E-2:

- The Dugan Utility helps you connect to a network.  
It is also used to update the firmware (see Chapter 6: *Updates*).
- The Dugan Control Panel offers expanded operational capabilities.

Insert the USB thumb drive (or CD) supplied with the Model E-2, or download the latest version from:

<http://www.dandugan.com/downloads>

- OR -

<http://tech.groups.yahoo.com/group/duganusers/files/>

To connect the Model E-2 directly to a computer, use the rear panel Ethernet jack. An older PC may require a crossover cable.

Use a straight Ethernet cable to connect to a network.

We strongly recommend that Windows users turn the Windows firewall off. The Windows Firewall blocks port 9776 used by the Dugan software to communicate. If you must leave the Windows firewall on, either open this port or use the workaround described in *Connecting when Windows Firewall is On* on page 29.

We recommend turning off the computer's WiFi during this process because it sometimes interferes. You can turn it back on after the connection has been established.

For those who wish to set a specific IP address, proceed to *Software Configuration for a Specific IP Address* on page 28.



---

## Establishing Network Connections

---

iPad

We recommend using a computer to complete your network connection before using the iPad app.

---

1. Launch **Dugan-Utility-yyyymmdd.jar**.

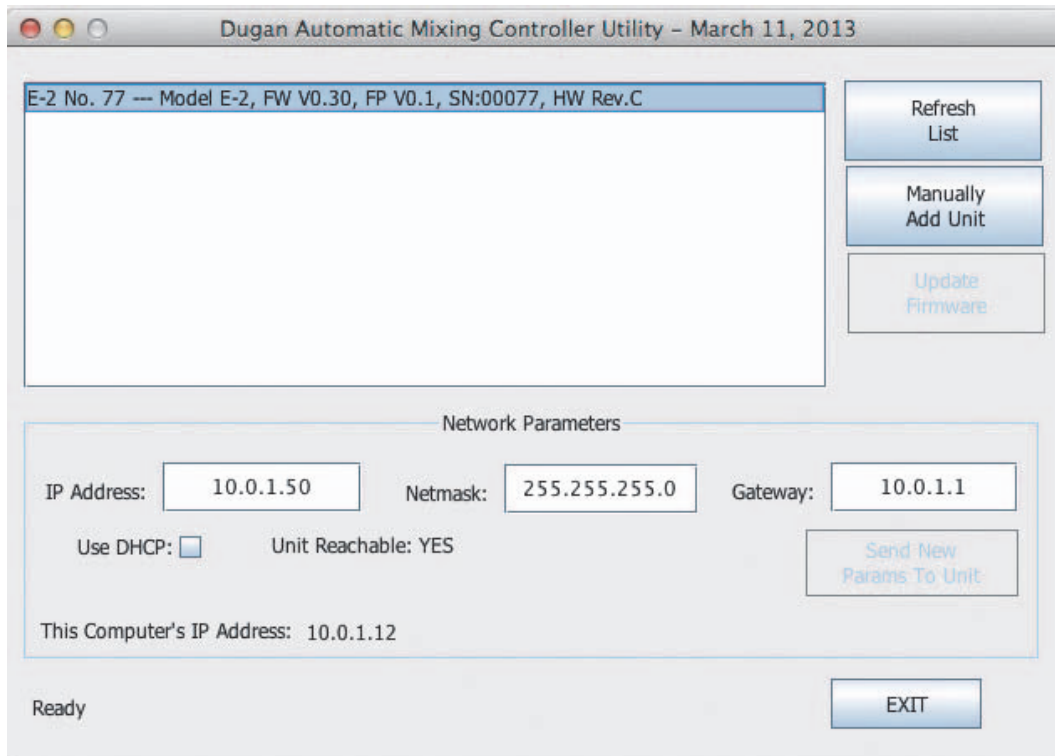

**Figure 3-5** Dugan Utility

2. Wait a minute and if the list pane is blank, click **Refresh List**.  
If the list pane remains blank, proceed to *Manually Add Unit* below.  
If the list pane displays Dugan units, continue.
3. Click on the first unit in the list so it is highlighted.  
The Network Parameters section displays information about that unit.  
If **Unit Reachable** is **YES**, you are ready to use the Dugan Control Panel with that unit. If you have additional Dugan units to connect, select the next unit in the list and repeat this step. If you are finished with installation, proceed to Chapter 4: *Dugan Control Panel*.  
If **Unit Reachable** is **NO**, proceed to the next step.
4. Power down the Model E-2.

5. Hold down the channel 1 **mute** button during the entire power up sequence.

This resets all network parameters to their factory default values.

Power up is finished when all LEDs stop flashing.

6. Click **Refresh List**.

7. Click on the first unit in the list so it is highlighted.

If **Unit Reachable** is **YES**, you are ready to use the Dugan Control Panel with that unit. If you have additional Dugan units to connect, select the next unit in the list and repeat Step 3. If you are finished with installation, proceed to Chapter 4: *Dugan Control Panel*.

If **Unit Reachable** is **NO**, proceed to the next step.

8. Select the **Use DHCP** parameter.

9. Click **Send New Params to Unit**.

10. Click **Refresh List**.

11. Highlight the unit in the list pane again.

If **Unit Reachable** is **YES**, this unit is ready to use with the Dugan Control Panel. If you have additional Dugan units to connect, select the next unit in the list and repeat Step 3. If you are finished with installation, proceed to Chapter 4: *Dugan Control Panel*.

If **Unit Reachable** is **NO**, proceed to the next step.

12. De-select the **Use DHCP** parameter.

13. Copy **This Computer's IP Address** to the **IP Address** field, and increase the value in the last (fourth) group by one.

For example, if **This Computer's IP Address** is 192.168.1.101, set **IP Address** to 192.168.1.102.

14. Click **Send New Params to Unit**.

15. Click **Refresh List**.

16. Highlight the unit in the list pane again.

If **Unit Reachable** is **YES**, this unit is ready to use with the Dugan Control Panel. If you have additional Dugan units to connect, select the next unit in the list and repeat Step 3. If you are finished with installation, proceed to Chapter 4: *Dugan Control Panel*.

If **Unit Reachable** is **NO**, see *Using the Internally Stored Dugan Control Panel* on page 27.

---

## Manually Add Unit

If the Dugan unit does not appear in the Dugan Utility list pane, you can manually add the unit:

1. Power down the Model E-2.
2. Hold down Channel 1's **mute** button and power up the unit.  
This performs a network reset.
3. Click **Manually Add Unit**.
4. Enter the default IP address: 192.168.1.xx  
xx = last two digits of serial number, unless they are 00, in which case enter 100.
5. Click OK to exit the dialog.
6. Click **Refresh List**.

If the list pane is still blank, see below.

## Using the Internally Stored Dugan Control Panel

Normally, the Dugan Control Panel is run from the **Dugan-Control-Panel-vxxx.jar** file. However, if for any reason you do not have that file or an Internet connection, you can run the Dugan Control Panel from a copy stored in the unit.

---

iPad

*It is not currently possible to run the internally stored Dugan Control Panel from an iPad.*

---

To run the internally stored Dugan Control Panel:

1. Launch your browser.
2. Enter the IP Address of the unit. '  
If you do not know the IP Address, continue
3. Hold down Channel 1's **mute** button and power up the unit.  
This performs a network reset, which sets a default IP address: 192.168.1.xx  
xx = last two digits of serial number, unless they are 00, in which case enter 100.
4. Enter this address in your browser.

If you still cannot connect the device to your computer, consult the *duganusers* Yahoo group (<http://tech.groups.yahoo.com/group/duganusers>) or contact Dan Dugan Sound Design.

## Software Configuration for a Specific IP Address

This section explains to users with IT expertise how to set a specific IP address for any Dugan unit on the network.

1. Launch **Dugan-Utility-vxx.jar**.

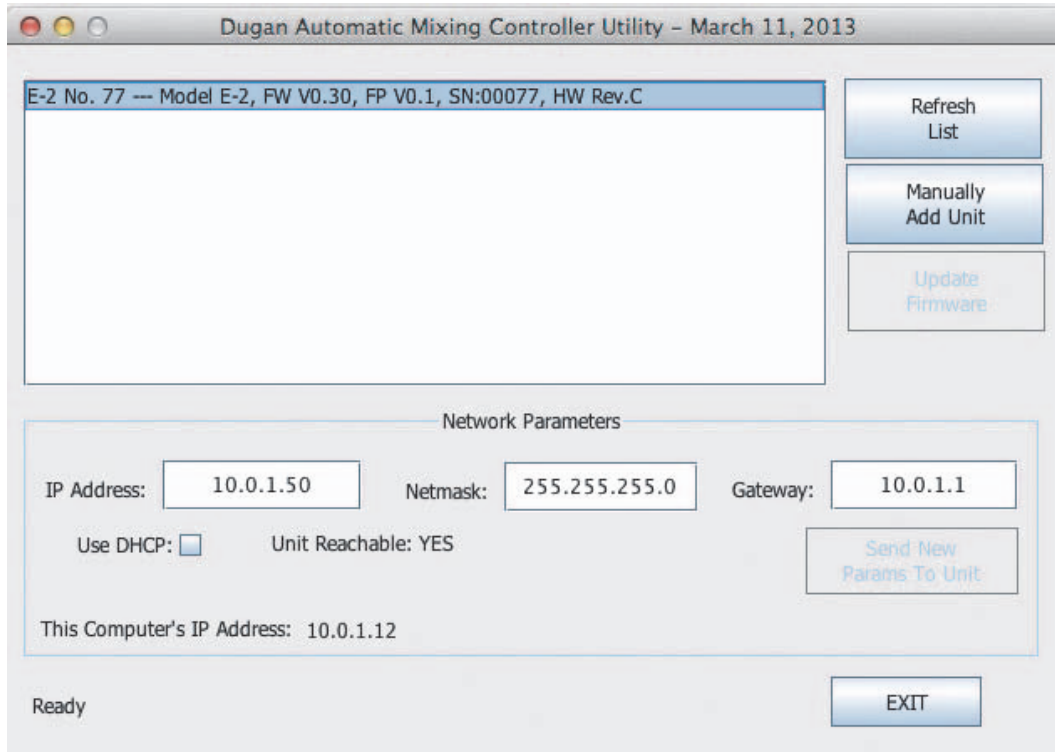

**Figure 3-6** Dugan Utility

2. Wait a minute and if the list pane is blank, click **Refresh List**.  
If the list pane remains blank, skip back to *Manually Add Unit* above.  
If the list pane displays Dugan units, continue.
3. Click on the first unit in the list so it is highlighted.  
The Network Parameters section displays information about that unit.
4. If **Use DHCP** is selected, de-select it.
5. Enter the desired IP address into the **IP Address** field.
6. Click **Send New Params to Unit**.  
The Model E-2 will reboot.

**Connecting when Windows Firewall is On**

The Windows Firewall blocks access to port 9776, which is used by the Dugan software. If you must leave the Windows Firewall on, you can operate the Dugan Control Panel in a browser window. Enter the Model E-2's IP address directly in the browser's address field. The browser uses the Dugan Control Panel that is stored in the Model E-2's hardware, not the version that you may have downloaded to your computer.



## Chapter 4: Stand-alone Operation

This chapter tells you how to operate the Model E-2 stand-alone (i.e., without the physical Model CP-2 Control Panel or the software Dugan Control Panel for Java or iPad).

### Settings

1. Put all the live mic channels in automatic mixing mode by deactivating **bypass** and **mute**.
2. Activate the **mute** buttons for all unused channels.

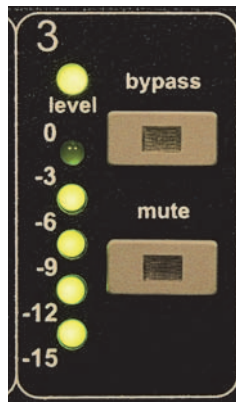

Figure 4-1 Channel controls

3. Using a normal speaking voice, adjust the console input trim controls to the highest possible gain without clipping.

The input gain to the Model E-2 should be high enough keep the **level** LED lit green during silences. If the input trim controls do not provide enough level, set the **+4/-10** switch to the **-10** position.

If the preamp gain controls are set too low, the inputs drop below their minimum operating level. This causes downward expansion to prevent feedback but the smooth ambience is disrupted.



Figure 4-2 Setting console preamp gain

4. Set the console faders to your normal operating positions.
5. Balance the preamp gain controls so the fluctuating ambient noise registers equally on the Model E-2's meters.

Note that raising the preamp gain of one channel causes its gain to rise and the others to fall; it's a balancing act. When balanced, all mics have equal access to the system gain.

6. If clipping occurs because someone speaks louder than expected, turn down all of the console's input trim controls the same amount, and raise the console master to compensate.

This procedure maintains the ambient noise balance required for optimal automatic mixing. A better method uses the weight controls provided by the Model CP-2 or Dugan Control Panels for Java or iPad. See Chapter 5: *Dugan Control Panel Software*.

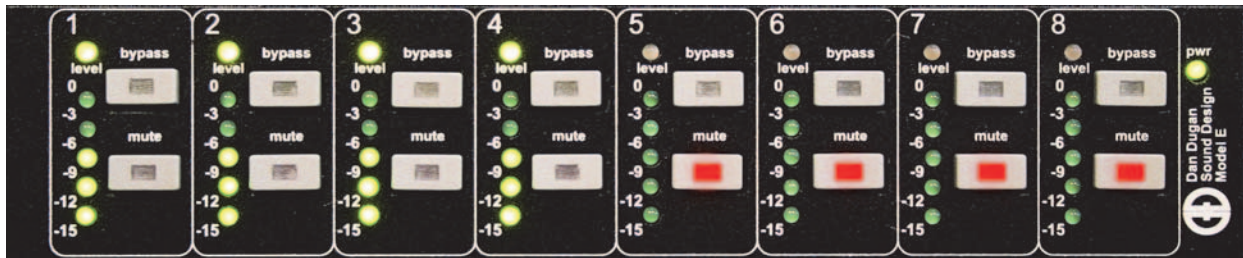

Figure 4-3 During ambience with 4 mics, auto mix gain displays should hover around -6 dB

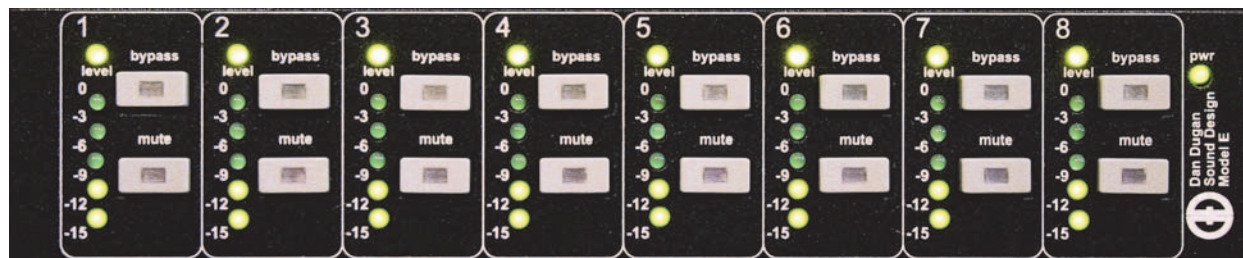

Figure 4-4 During ambience with 8 mics, auto mix gain displays should hover around -9 dB

**TIP:** To eliminate an unwanted noise in the mix, use the gain displays to locate the offending channel and activate its **mute** button.



## If You Must Use a Pre-fader Insert

The Dugan Speech System is more convenient to operate if patched post- rather than pre-fader. If your console allows this, skip this section. If you use a pre-fader insert, this section describes how to properly mute and pre-listen to muted channels.

### Muting Channels

Mics must be muted by using the Dugan's **mute** buttons. Pulling a fader down on the console will not properly mute a channel. Although that mic is no longer audible in the mix, it still contributes to the gain computations and causes ambient noise fluctuation. In the worst case, this could cut off a speaker.

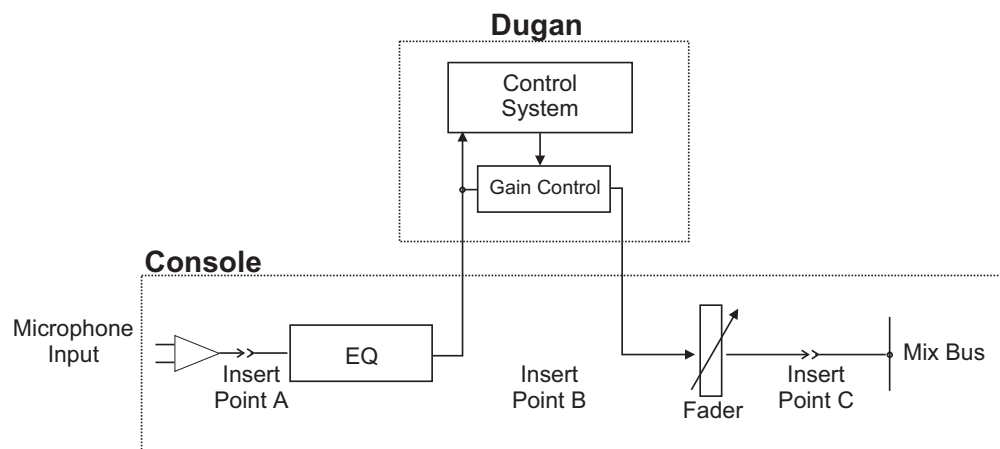

**Figure 4-5** Insert points on most analog mixers are at point B

To properly mute a channel:

- Leave the console faders up, adjust levels while people are talking, and mute a mic by pressing the Dugan's **mute** mode button. Enable the mic when needed by deactivating the **mute** button.

Muting mics does not alter the overall ambient sound mix: the Speech System compensates by slightly raising the ambient gains of the other mics to compensate for the gain subtracted by muting a mic. Note that this behavior is during ambience without input to any mic; while one or more mics receive speech input, the gain shifts to the active mics.

- OR -

- Use the **bypass** switch with the console fader pulled down. This keeps the mic instantly available on the fader but that channel is no longer in the control mix.

Be aware that **bypass** may generate a click if it interrupts room rumble, whereas the **mute** button does a quick-fade. The **mute** button can be used with the fader up; **bypass** is best used with the fader down.

## **Pre-listening to Muted Channels**

If your console allows listening to a mic before the insert point, you can mute on the Dugan.

If signal through the Dugan is required to pre-listen to a mic, pull the fader down and put the channel in **bypass** mode. When your mic check is done, switch the channel back to **auto** mode, and raise the fader so the Dugan can cue in the mic.

## Chapter 5: Dugan Control Panel Software

---

The Dugan Control Panel software has both Java and iPad versions. This chapter discusses the Java version and notes the iPad app's few differences.

---

**NOTE:** *After configuring settings with the Dugan Control Panel, it can be disconnected. All settings are retained and the unit continues to function on its own.*

---

The Dugan Control Panel provides additional controls and features not available from the hardware front panel:

- Channel **weight** control
- Channel **man** mode to bypass automixing with a soft switch
- Eight, twelve, and sixteen channel I/O modes
- Dugan Music System and Gain Limiting
- Groups a, b, and c
- Unit and channel naming
- Preset function to recall favorite settings
- Override function to solo a mic
- Master mute function
- Four auxiliary outputs from a mix bus matrix
- Input and output level meters



Figure 5-1 Dugan Control Panel

Launch the **Dugan-Control-Panel-xxxx.jar**. If this file is not available and you have an Internet connection, you can obtain the latest version from:

<http://www.dandugan.com/downloads>

- OR -

<http://tech.groups.yahoo.com/group/duganusers/files/>

If you do not have an Internet connection, you can use the version of the Dugan Control Panel stored inside the unit's firmware. See *Using the Internally Stored Dugan Control Panel* on page 25.

The Dugan Control Panel has three panes. The controls displayed in these panes depend on which Dugan device is selected in the Top Pane.

<b>Top Pane</b>	icons for all connected Dugan units
<b>Channel Pane</b>	<b>man, auto, mute, preset, override, group, weight, bypass,</b> and channel name controls
<b>Master Pane</b>	<b>OVER-RIDE, PRESET, MUTE, meters, system,</b> and <b>reset</b> controls

## The Top Pane

The Top Pane displays all connected Dugan units. The selected unit is enclosed by a yellow rectangle. Click on another unit to select it and deselect the previous unit.



**Figure 5-2** Top Pane

If all connected units do not appear in the Top Pane, see *Establishing Network Connections*.

To display a unit's IP address, hover the mouse over the unit's name.

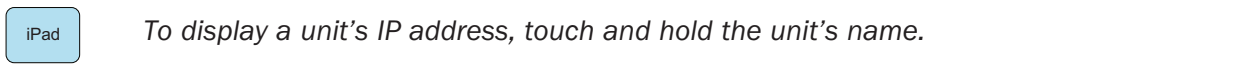

## Adding Units Manually

To add a unit manually with a known IP address, click the + sign at the right of the Top Pane and enter the IP address in the dialog that appears.

To add a unit manually without a known IP address:

1. Power down the Model E-2.
2. Hold down Channel 1's **mute** button and power up the unit.  
This sets a default IP address: 192.168.1.xx.  
xx = last two digits of serial number, unless they are 00, in which case enter 100.
3. Click the + sign at the right of the Top Pane.
4. Enter the default IP address.
5. Click **OK** to exit the dialog.

To display a unit's IP address, hover the mouse over the unit's name.

## Selecting Units to Display

The Dugan Control Panel finds all available units connected to the network automatically. Some facilities have multiple studios on the same network that operate independently. In that case, you may want to restrict the units shown in the Top Pane to those in your studio. To do this:

1. Hover the mouse cursor over the names of the units that you want to display, and note their IP addresses.
2. Ctrl-click on the + sign at the right of the Top Pane.  
The + sign turns red.
3. Quit and relaunch the Dugan Control Panel.  
It opens with **Auto Detect Disabled** in the Top Pane
4. Click on the red + sign, and enter the IP address of the first unit you want to add.
5. Repeat step 4 until your units all appear in the Top Pane.

Manually added units must also be removed manually. To remove manually added units from the Top Pane, shift-click on the + sign. A dialog appears to confirm that they have been removed.

To restore automatic detection, Ctrl-click on the + sign, which turns white.

## Setting Controls

Controls can be adjusted five ways:

- Enter a dB value in the numeric field.
- Drag in the numeric field (not on iPad).

When a slider is present:

- Drag the slider up or down.
- Click in the slider track to raise or lower the value by 0.5 dB.
- Ctrl-click anywhere on the slider to reset its value to 0 (touch and hold on iPad).

## Naming Units and Channels

Connected units are displayed in the top pane in alphabetical order. Use names with number prefixes if you wish to display them in your own order.

To name a unit and its channels:

1. Select a unit in the top pane.
2. Select the yellow text in the right pane (under the Dugan logo) and type a name.
3. Press the Enter key on the keyboard to set the name.
4. To name a channel, select the yellow text and type a name.
5. Press the Enter key on the keyboard to set the name.

Channel naming is cleared by pressing **reset** (see page 48).

## Channel Pane

The Channel Pane contains the controls and indicators for each channel. Channels are always in one of three modes: **man**, **auto**, or **mute**. The active channel mode illuminates. All transitions are made with a smooth, rapid fade. Select a channel mode by pressing the individual mode buttons or the Master **PRESET** button.

Figure 5-3 shows a typical system: channels 1–4 in **auto** with ambient noise, and channels 5–8 in **mute**.

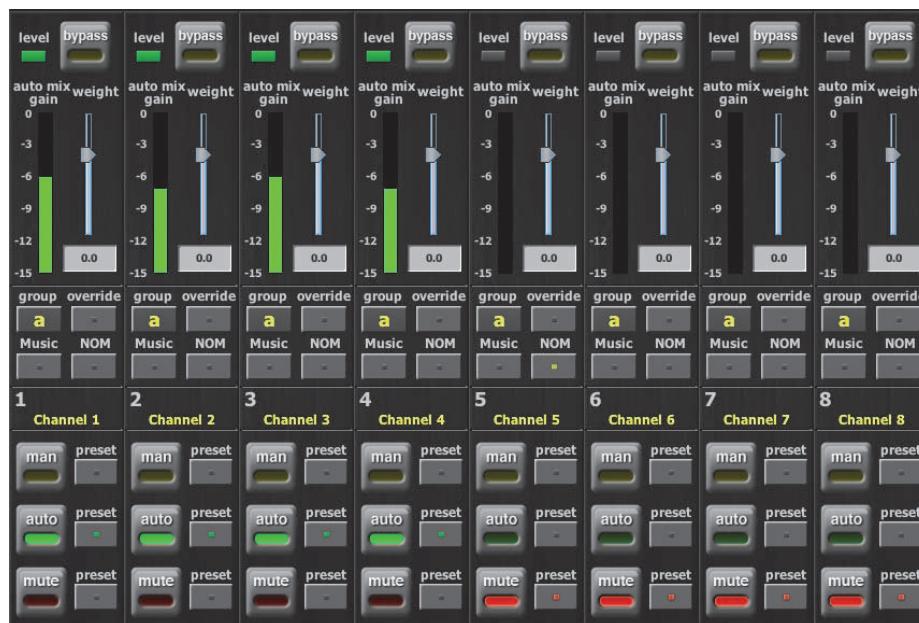

Figure 5-3 Channel Pane

## Level Indicator

Each channel has a **level** LED that lights green when the audio level is adequate for automatic mixing. It should remain green when no one is talking.

- If the **level** indicator blinks, raise the console's channel input gain, and/or move the **+4/-10** switch on the rear panel to **-10**.
- If the **level** LED lights red, lower the console's channel input gain and/or move the **+4/-10** switch on the rear panel to **+4** until it stays green at all times.

## Bypass

When **bypass** is active, the signal passes through without A/D and D/A conversion or automixing. A bypassed channel appears inactive, with all lights extinguished.

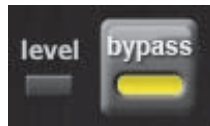

Figure 5-4 **bypass** button lit

**Man** and **bypass** modes are similar:

- **bypass** makes an instantaneous transition, which can cause an audible click. It is a hardware bypass and therefore has no signal latency.
- **man** performs a quick fade without sonic artifacts. It has the same signal latency as **auto** mode.

Since analog channels 1–12 are bypassed when the power is off, it is not necessary to unpatch the Model E-2 if not in use.

To deactivate **bypass**, you can:

- Click **bypass** again;
- - OR -
- Click any of the three channel mode buttons.



## Channel Modes

There are three channel modes: **man**, **auto**, and **mute**. Changing modes initiates a half-second fade to the new mode. Like radio buttons, you can only choose one mode at a time.



**Figure 5-5** Channel modes

### **Man**

In **man** mode there is no automixing, and the signal passes through at unity gain.

Even though **man** and **bypass** modes perform similar functions, we recommend using **man** during live mixing to prevent clicks.

### **Auto**

This is the normal Dugan automixing mode.

### **Mute**

The channel is muted when **mute** is active.

## Preset

Use the Preset function to store your favorite channel mode settings, which may be restored by pressing the Master **PRESET** button. When the unit powers up, the channels default to their preset modes.

To set channel presets:

1. Click the channel **preset** button next to the desired channel mode button.
2. For all unused channels, click the **preset** button next to the **mute** button.

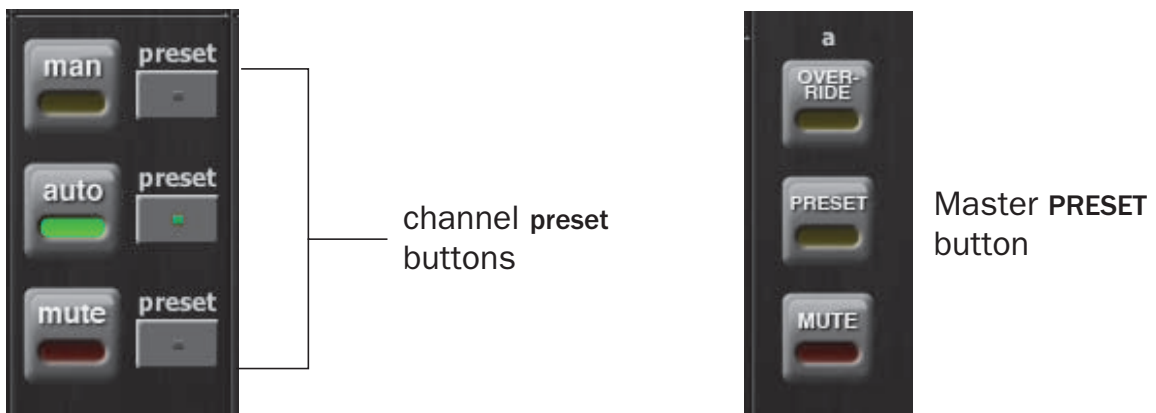

Figure 5-6 Channel **preset** (left) and Master **PRESET** (right) buttons

The preset indicators should mirror your normal working combination of input modes. The normal condition can then be restored by pressing the Master **PRESET** button.

## Channel Groups

Each channel can be assigned to one group: a, b, or c. Each group functions as a separate, independent automatic mixer that can span multiple linked Dugans. Channels assigned to groups need not be contiguous.

Applications where groups are helpful include:

- **Separate Rooms:** Assign the mics in each room to different groups so they function as separate automatic mixers.
- **Stereo Panning:** Assign the mics panned left, right, and center to groups a, b, and c, respectively, to maintain a stable stereo ambience.

To assign a channel to a group, click the **group** button until the desired group letter appears. The channel strip background is tinted green (**group b**) or blue (**group c**); **group a** is not tinted (Figure 5-7). A set of **OVERRIDE**, **PRESET**, and **MUTE** buttons appears in the Master Pane for each group.



Figure 5-7 Channels in three groups

### Override

Override can be used to instantly mute all mics except one (the host or chairperson). However, any number of mics can be included in the override group. It can thus be used to make a dramatic A/B comparison between automatic and conventional mixing.

To assign channels to an override group, activate the **override** button on each channel.

Pressing the Master section **OVER-RIDE** button puts channels with their **override** buttons lit into **man** mode. All other channels are muted. Press the **OVER-RIDE** button again to restore normal automixing operation.

### Meters

The meters have three display modes.

Table 5-1 Meter modes

	Meter Displays	Meter Color
auto mix gain	action of the Dugan Speech System	green
input	input level	yellow
output	output level	blue

The default meter display is **auto mix gain**. This is the most useful choice during normal operation; the input and output meters are only used when setting or checking levels.

Click on the Master **meters** button to toggle through the three meter display modes.

## Weight Controls

The **weight** controls set the side-chain levels for each channel into the control system. This establishes the relative sensitivity of the automatic mix for the channels in use. *They do not change the mix levels.* When the **weight** controls are balanced, each mic has an equal opportunity to take over the system: when one person talks into one mic, he/she gets all the **auto mix gain** and the others get turned down.

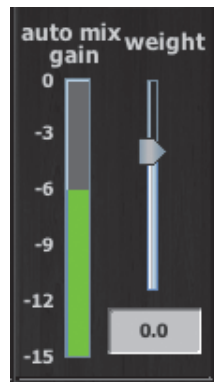

Figure 5-8 Weight controls

The **weight** controls should be used to balance the channel **auto mix gain** indicators when no one is talking. If a console preamp trimmer is turned down, that channel's **weight** control can be turned up to re-balance the automixing, and vice-versa.

To adjust the weight setting, click and drag the **weight** slider or enter a number in the numeric field. Ctrl-click the **weight** slider to reset it to 0.

iPad

Touch and hold the **weight** slider to reset its value to 0.

It is important to understand that **weight** does not set that mic's *level* in the mix when that person speaks, but only its *sensitivity* in activating automatic mixing. The Speech System detects the *ratios* of the levels between channels, not their absolute levels. *The weight control is not a gate threshold!*

The following example illustrates how **weight** affects **auto mix gain** (see Figure 5-9).

### Raising the **weight** control for one channel:

- increases that channel's **auto mix gain** display during ambience and decreases it slightly for the others;
- makes it more difficult for others to speak when someone speaks into the channel with the higher **weight** setting.

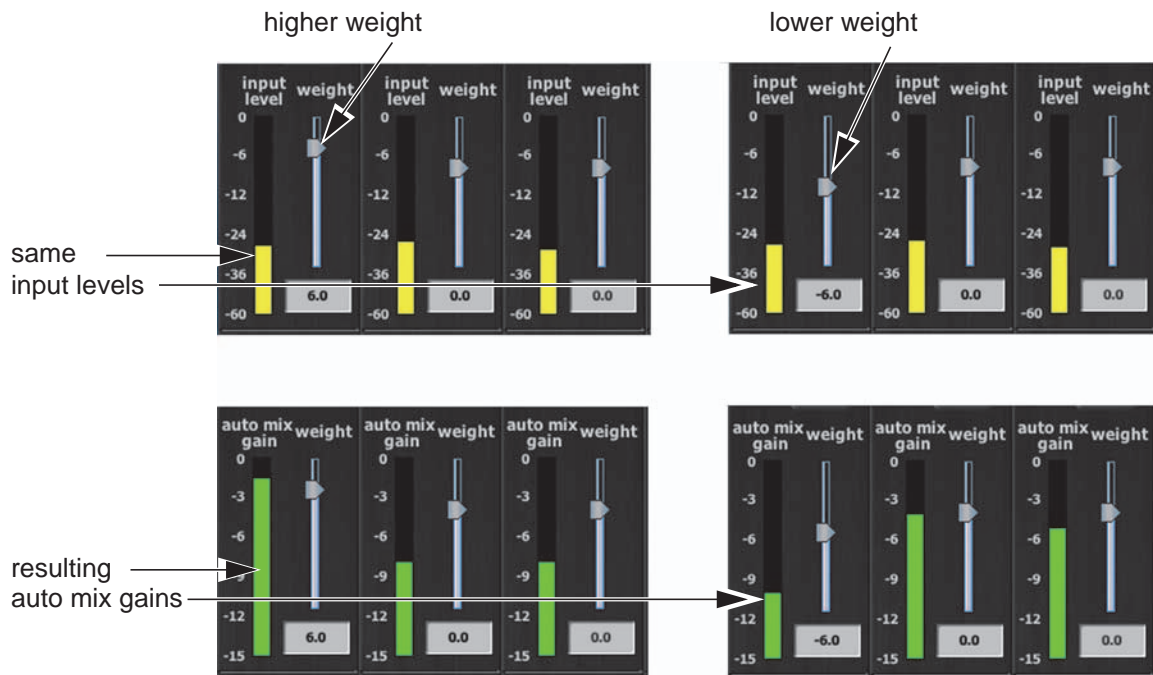

**Figure 5-9** How changing one channel's weight control during ambience affects the auto mix gains

### Lowering the **weight** control for one channel:

- decreases the **auto mix gain** display during ambience for that channel and increases it slightly for the others;
- makes it more difficult for that channel's talker to be heard over the others.

For optimal performance, balance the **weight** controls so the channel gains display approximately equally when no one is talking. If there is ongoing noise near one mic (e.g., computer fan or air vent), suppress it by reducing that channel's **weight**. Of course, you will hear that noise increase when that talker speaks.

Figure 5-10 shows eight- and four-mic systems with appropriate auto mix gain displays when no one is talking.

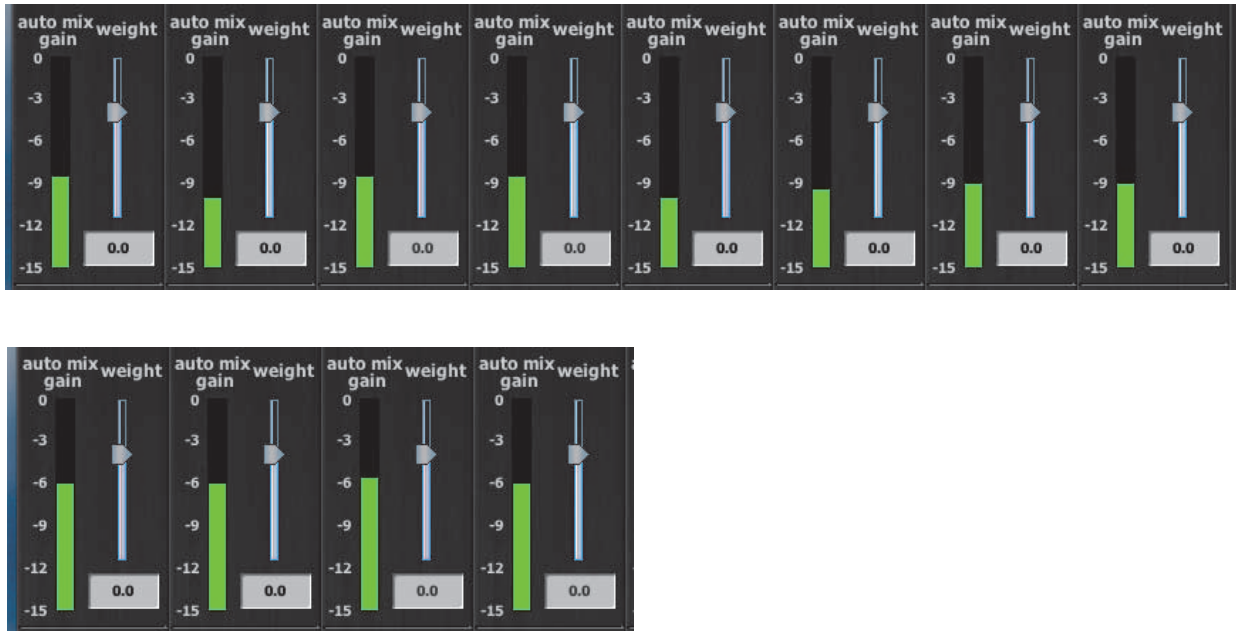

**Figure 5-10** Multiple mic ambience: auto mix gain hovers around -9 dB for eight mics, -6 dB for four mics

## Master Pane

The content of the Master Pane changes to reflect the Dugan device selected. In the figure below, the selected device is a Model E-2.

The following version numbers are displayed below the Dugan logo.

- the selected unit's firmware
- the currently running Control Panel (CP-J) software

This section documents the Master Pane's controls and indicators.



**Figure 5-11** Master Pane: Analog settings (left), Digital settings (center), Music System controls (right)

The Master indicators are:

- **online:** lights when the unit is connected to the Dugan Control Panel.
- **analog/digital, master/slave, +4/-10:** show their rear panel switch settings.

The Master controls, located on the far right, include **#ch**, **reset**, **meters**, **system**, **mix bus**, **OVER-RIDE**, **PRESET**, and **MUTE**. A set of **OVER-RIDE**, **PRESET**, and **MUTE** buttons appears for each active group. Each control is discussed below.

### Selecting the Number of Channels

The state of the rear panel **ANA-DIGI** switch determines the number of possible channels. Press the **#ch** button to toggle between the two available values:

- **ANA:** 8 or 12
- **DIGI:** 8 or 16

See *Rear Panel I/O Connections* on page 19 for a full explanation of these options.

## Reset

Press the **reset** button to restore the unit to its default settings.

## Meters

Click on the **meters** button to toggle through the three meter display modes.

**Table 5-2** Meter modes

	<b>Meter Displays</b>	<b>Meter Color</b>
<b>auto mix gain</b>	action of the Dugan Speech System	green
<b>input</b>	input level	yellow
<b>output</b>	output level	blue

## System

When multiple Dugan *units* are linked, groups a, b, and c can span linked units. Groups operate as independent automatic mixers, and do not have to use contiguous channels.

It is possible to have multiple *systems* of linked units on your network (i.e., separate studios on the same network). These units will all appear in the top pane. The Model E-2 allows up to 16 separate systems on a network.

To separate multiple systems:

1. Select the first unit to include in the system by clicking it in the top pane.
2. Click the **system** button and select a unique number for that system.
3. Repeat for each unit in that physically linked system, making sure to use the same number for each unit in the system.
4. Repeat steps 1–3 for each system.
5. To query which system a unit belongs to, select it in the Top Pane and view its number on the **system** button.

To control which units are displayed in the Top Pane, see *Selecting Units to Display* on page 38.



## Mix Bus Matrix

Click the **mix bus** button to open the mix bus matrix screen (see Figure 5-12). In eight-channel mode, an internal mix matrix can route processed or unprocessed inputs to four mix bus outputs (**aux out 1-4**) on the **AUDIO I/O 9-12** connector.

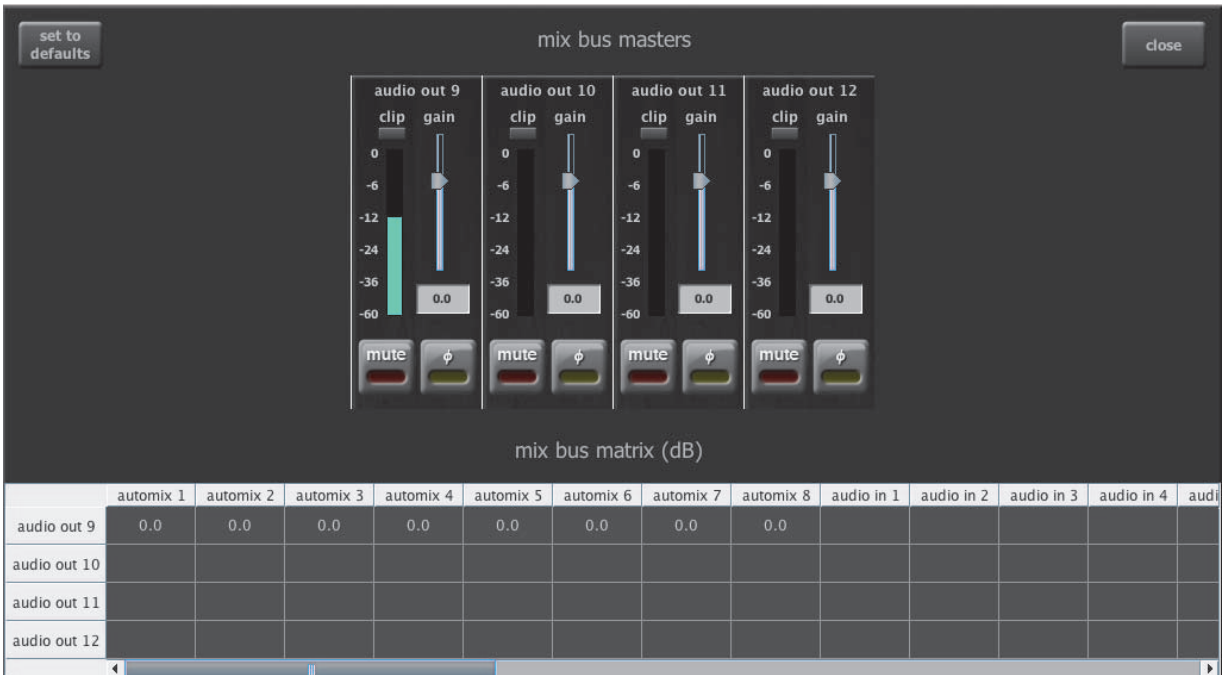

**Figure 5-12** Mix bus matrix screen in Dugan Control Panel

The default mix bus assignment routes **automix 1-8** to **out 9**. You can re-establish the default routing by clicking the **set to defaults** button (at top-left).

Scroll horizontally to see all available processed and unprocessed signals.

A blank cell means *no connection*. A cell with **0.0** means *unity gain*.

To assign your own routings, enter values (-96 to +31.5 dB) in the desired mix bus matrix cells.

A master fader trims the gain of each mix bus output. Gain values may also be entered numerically below the fader. You can Ctrl-click the fader to reset its value to 0.

iPad

Touch and hold the **gain** slider to reset its value to 0.

The level meter shows the resulting output level.

You can mute the output and reverse the signal's polarity.

## Group Master Controls

The Master Pane displays a set of group master control buttons for each group in use.

### Override

Activating the Master **OVERRIDE** button has the following effect on individual channels:

- Channel **override** button active: puts the channel in **man** mode with full gain (no automixing);  
- OR -
- Channel **override** button inactive: mutes the channel.

De-activating the Master **OVERRIDE** button returns the channels to normal operation.

Select channel(s) to include in the override group by activating their **override** button(s).

Remove channel(s) from the override group by deactivating their **override** button(s).

### Preset

Clicking the Master **PRESET** button sets the channel modes (**man**, **auto**, **mute**) to those shown on each channel's **preset** buttons. Use these settings to store your favorite channel mode settings. When the unit powers up, the channels default to their preset modes.

### Mute

Click the **MUTE** button to mute a group. Click it again to unmute the group.

---

## Dugan Music System and Gain Limiting

These functions require the physical Model CP-2 or Dugan Control Panels for Java or iPad.

### Dugan Music System

The Dugan Music System is a soft-gating or ducking system with its threshold set by an audio side-chain, typically from a mic measuring the ambient sound level. Each channel has a 2:1 expansion ratio below the floating threshold. There are three Music System Threshold inputs on the **AUDIO I/O 9-12** connector (channels 9-11), one for each group.

Consider the following before placing the sensing mic:

- Place the sensing mic in the same area, and pointing in the same direction as the program mics.  
This samples, as closely as possible, the ambient sound picked up by the program mics.
- Use the same type of mic for program and sensing applications.
- Do not place the sensing mic close to an individual voice or instrument.
- Do not point the sensing mic at a pit orchestra.
- Do not put the sensing mic in the back of the house because of the time delay.

Patch the preamplified sensing mic to input 9, 10, or 11 (group a, b, or c) on the **AUDIO I/O 9-12** connector. The direct output of a console input strip is typically used, with the mix buses deselected. Set the console input gain for the sensing mic 10-15 dB higher than the program mics.

The Music System can also be used to duck an audience mix when the people on stage talk, attenuating the sound of the PA in the room. Use an aux send of the stage vocal mix to supply the threshold signal instead of a mic.

### Setting up the Music System

Some channels can be set to the Music System while others are in the Speech System. Unlike the Speech System, the Music System channels should be patched post-EQ, *pre-fader* so that fader and threshold adjustments remain independent.

To set up the Music System:

1. Patch up to three reference mic signals (one for each group) for the Music System threshold inputs as described on page 21.
2. Click the arrow on the right edge of the Master Pane to open the Music System panel.

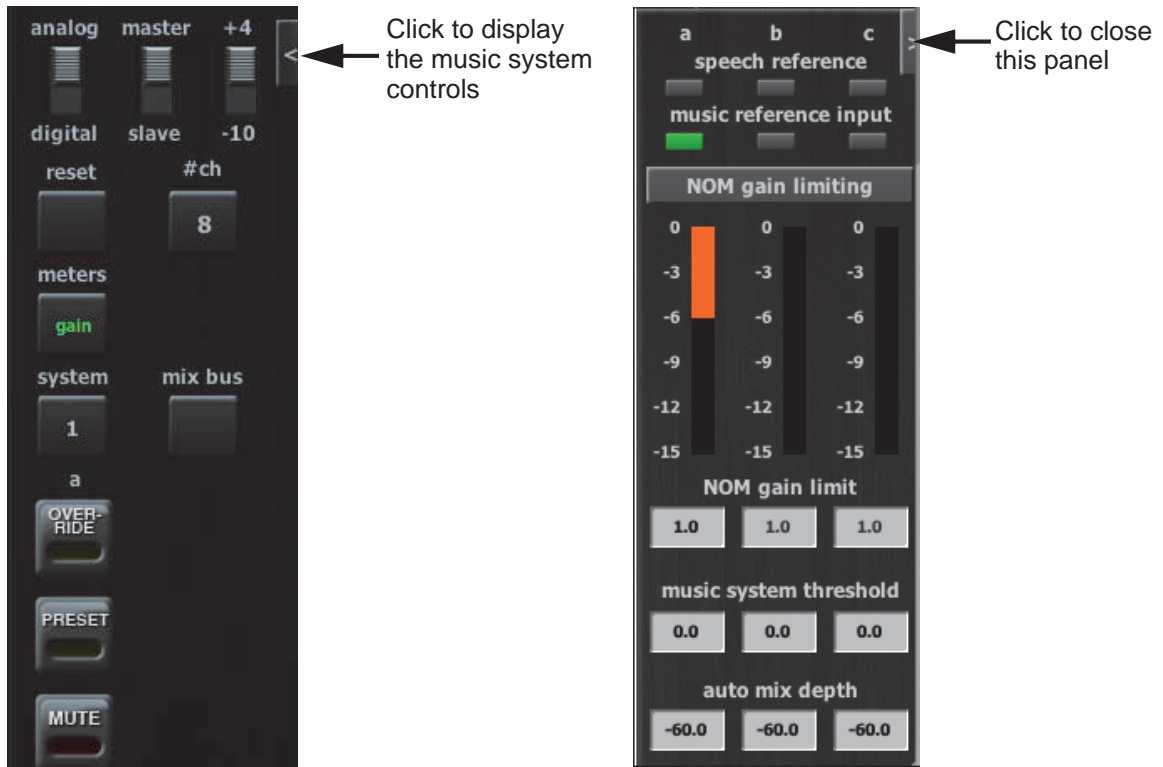

Figure 5-13 Dugan Music System controls

3. Start with the three Master **music system threshold** controls set to 0 dB.
4. Activate the **music system** buttons on the desired channels.
5. Start with all channel **thresh** controls at 0 dB.
6. Activate the **auto** buttons for all channels in use, and the **mute** buttons for unused channels.
7. On all channels, activate the **preset** button adjacent to the selected mode.  
This preserves your settings when the unit is powered off and on.
8. On the console, set a ballpark level using the preamp gain of the music system threshold's mic so all music system channels hover around -15 dB.

9. Use the Master **music system threshold** settings to fine tune the master threshold for each group.

There are several ways to enter values (see page 38).

If all the channel **auto mix gain** displays stay at full gain, the threshold signal is missing or too low.

10. Fine tune individual channels using their **thresh** controls so the **auto mix gain** display stays close to -15 dB.

---

iPad

*To close the Music System pane on an iPad, swipe it to the right.*

---

## Controlling Ambience

The Music System does not maintain constant ambience like the Speech System.

If you want to smooth out the ambience:

1. Click the arrow on the right edge of the Master Pane of the Dugan Control Panel to display the Music System controls.
2. Reduce the maximum attenuation by setting the **auto mix depth** field to -10 dB.

This limits the range of downward expansion and mixes in a steady ambience.

If you use the Model CP-2 Control Panel, the **last hold** function is available: press both the Master **OVERRIDE** and **PRESET** buttons at once. Their LEDs blink to indicate that **last hold** is on; toggle it off the same way. The **last hold** function keeps the last mic on that stays above -3 dB gain for 0.5 seconds. When another mic passes the same criteria, it becomes the **last hold** mic.

---

**NOTE:** *The Music and Speech Systems operate independently, but the **auto mix depth** control is global to both. Use different groups if necessary.*

---

---

iPad

*To close the Music System pane on an iPad, swipe it to the right.*

---

## Gain Limiting

Gain Limiting reduces master gain as new mics enter the system, thus avoiding feedback and noise. Acoustic gain increases as each mic comes on, whether this occurs manually, by placing that channel in **man** mode, or automatically using the Music System. Gain Limiting is the only automatic mixing function that can be active when the channel is in **man** mode. Gain Limiting is controlled by the **NOM** (Number-of-Open-Mics) channel buttons and the master **NOM gain limit** field (see Figure 5-13).

---

**NOTE:** Since the Model E-2 has no master audio channel, Gain Limiting reduces the gain on all input channels for which **NOM** is active.

---

Unlike typical NOM functions on other systems, Dugan Gain Limiting doesn't just count how many mics are on. It sums the instantaneous gains of all the channels with **NOM** active (including partially attenuated channels), compares them to the **NOM gain limit** threshold, and reduces the gain appropriately. Gain Limiting works independently for each group.

Conventional automatic mixing implementations always assume an NOM of 1. This can be effected on the Dugan by setting the **NOM gain limit** field to **1**, which maximizes gain for each mic. Activate the **NOM** buttons for each channel you wish to be included in the gain computation. The Master Gain Limiting display shows 3 dB of gain reduction when two mics are on, 6 dB of reduction with four mics on, etc.

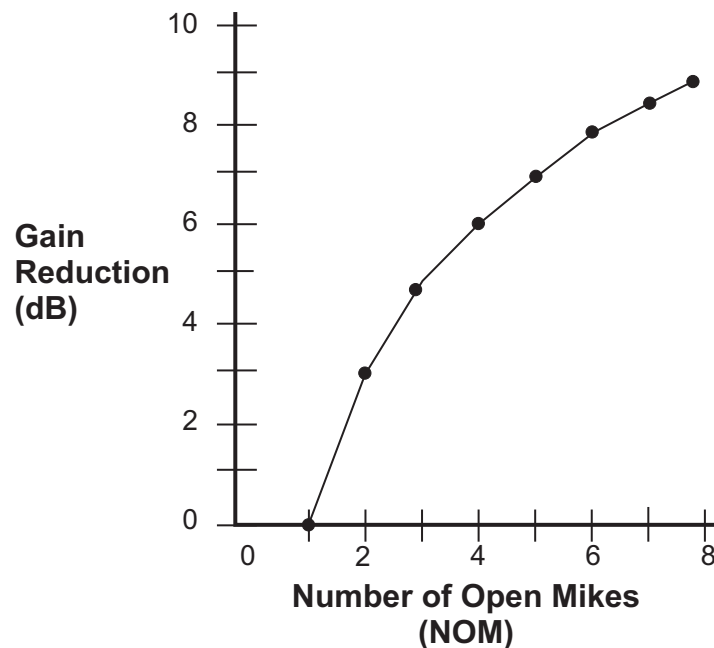

Figure 5-14 NOM and gain reduction

The Dugan's unique implementation allows you to set the number of mics at full gain before gain limiting occurs. Set the **NOM gain limit** field in the range 1–10 (see page 38 to learn how to set controls).

For example, if there is enough gain before feedback to tolerate four open mics, set the **NOM gain limit** to 4. Gain reduction begins when the fifth mic turns on.

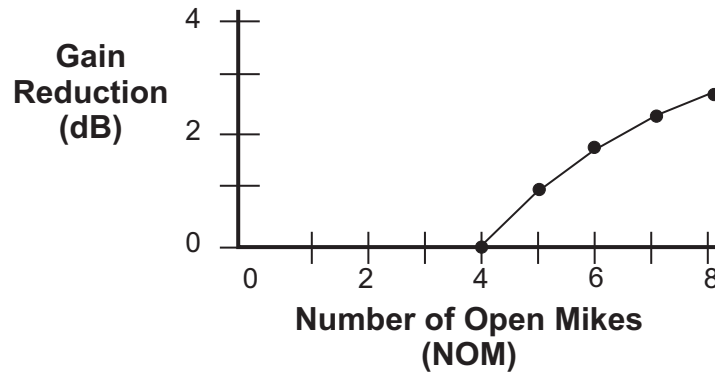

Figure 5-15 NOM is 4

### Gain Limiting Tip

To see how Gain Limiting works:

1. Turn on **NOM** for all channels.
2. Mute all channels.
3. Click the arrow on the right edge of the Master Pane to open the Music System panel.
4. Set the **NOM gain limit** to 1.
5. Switch channels 1 and 2 to **man** mode.  
Note the master gain reduction on the **NOM gain limiting** display.
6. Switch additional channels to **man** mode to see more attenuation.
7. Click and drag in the **NOM gain limit** field to set it to a higher number than 1.  
Note the difference in the **NOM gain limiting** display.

### Previewing Mics

To preview mics on the console when Gain Limiting is active, we recommend using the **bypass** switch with the fader down to pass signal through the Dugan. This sends the signal through without the gain limiter affecting other channels.

## Gain Limiting and the Speech System

The Speech System always maintains  $NOM = 1$ , which prevents Gain Limiting from sensing excess gain. Typically, the **NOM** controls have no effect when using the Speech System. However, the **NOM** function can help avoid feedback when

- mics are switched to manual;  
- *OR* -
- the Master **VERRIDE** button is pressed with multiple mics selected.

If either case applies,

1. Turn on **NOM** for all channels.
2. Set the **NOM gain limit** field to **1**.

If channels are set to both Speech and Music Systems, you can choose whether they should interact. If you do not want the master gain reduction of the Music System mics to affect those in the Speech System, turn the **NOM** buttons off for the Speech System channels.



## Chapter 6: Updates

---

Updates for the Model E-2 can be downloaded.

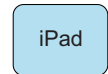

To update the firmware in your Dugan unit, iPad users must connect the Dugan to a computer and run the Dugan Utility.

To update the Dugan Control Panel for iPad, connect to the Apple App Store.

---

To update your device's software and firmware:

1. Connect to the Internet and download **Dugan-Software-yyyymmdd.zip** from:  
<http://www.dandugan.com/downloads/>

- OR -

<http://tech.groups.yahoo.com/group/duganusers/files/>

After the download is complete, the Internet connection is no longer necessary.

2. Unzip the software package.

It contains the **Dugan-Control-Panel-vxxx.jar** and **Dugan-Utility-yyyymmdd.jar**. The Dugan Utility contains the latest versions of both the firmware and the safety copy of the Dugan Control Panel that loads automatically into the unit.

To revert to a previous version, use the older version of the Dugan Utility.

3. Connect the computer to the Dugan units you wish to update.
4. Launch **Dugan-Utility-yyyymmdd.jar**.

The Dugan Utility window appears.

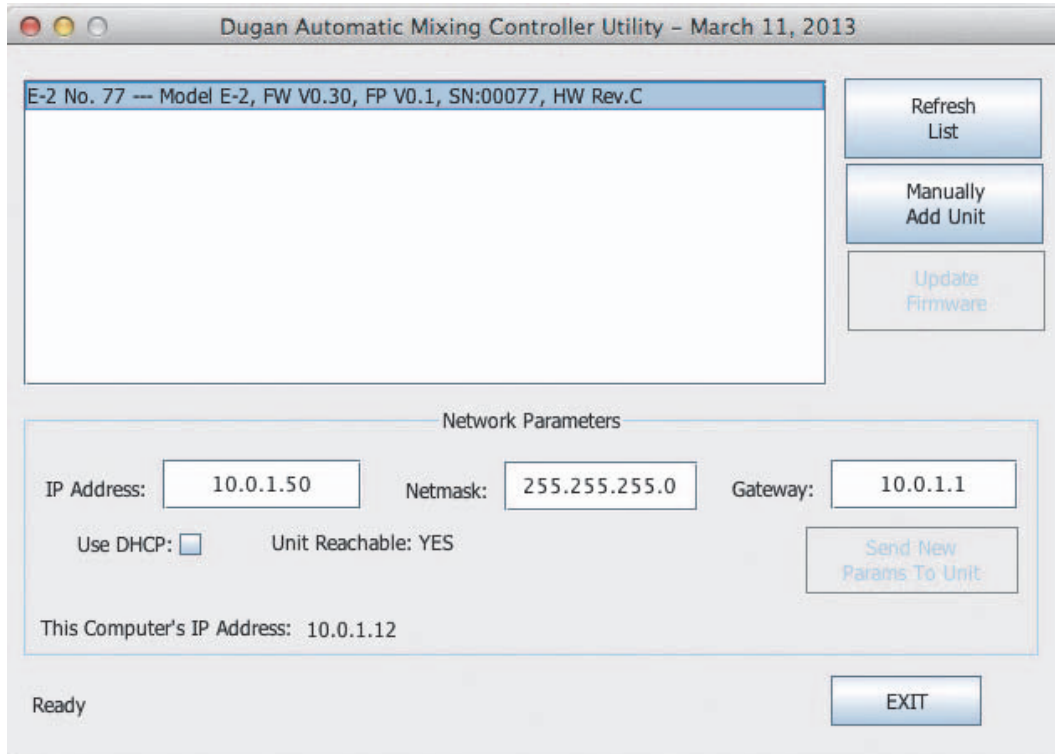

**Figure 6-1** Dugan Utility

- If you do not see the Dugan unit(s) on your network in the list, see *Establishing Network Connections* on page 25.
5. Select the unit to update from the list.
  6. Make sure **Use DHCP** is *NOT* selected for that unit.  
Under certain network conditions, DHCP is not compatible with the firmware update process.
  7. Click on **Send New Params To Unit**.
  8. Click **Update Firmware**.  
The unit reboots after the update completes.
  9. Repeat steps 5 through 8 for each unit you wish to update.

---

**NOTE:** To force an update when the **Update Firmware** button is not blue, Ctrl-click the button.

---

---

**NOTE:** If the firmware update process fails, your unit may not pass audio. To recover from this condition, repeat steps 5 through 8 above, but Ctrl-click the **Update Firmware** button.

---

## Appendix A: Power-up Commands

The Model E-2 can execute five power-up commands that can choose essential settings without being connected to a computer or iPad.

Select the command by holding down a specific button during the entire power-up process (see table below). Power-up is complete after the LEDs stop flashing.

To execute more than one command, turn the unit off after it finishes powering up, and repeat for the next command.

**Table A-1** Power-up commands

	channel 1	channel 2	channel 3	channel 4
<b>bypass</b>	System Reset	DHCP On	N/A	12/16 channel mode
<b>mute</b>	Network Reset	N/A	N/A	8 channel mode

### System Reset

Hold down the channel 1 **bypass** button to set all parameters to factory default settings and clear label text. We recommend executing this command (just like “zeroing out” a console) before starting a new installation.

### Network Reset

Hold down the channel 1 **mute** button to set these parameters to their default values:

	Model E-2
<b>IP Address</b>	192.168.1.xx*
<b>Netmask</b>	255.255.255.0
<b>Gateway</b>	192.168.1.254
<b>DHCP</b>	off

\*xx = last two digits of serial number, unless 00, then use 100

### DHCP On

Turning DHCP on requests that the network assign an IP number to the Model E-2, if the network has that capability. To turn DHCP on, hold the channel 2 **bypass** button down.

## **Number of Channels Mode**

Hold down the channel 4 **bypass** button to select 12 (analog) or 16 (ADAT) channel mode.

Hold down the channel 4 **mute** button to select 8-channel mode.



**Table B-1 AUDIO I/O 1-4 Connector Pinout**

<b>Pin</b>	<b>Signal</b>
1	Ch 4 Out Hi
2	Ch 4 Out Gnd
3	Ch 3 Out Lo
4	Ch 2 Out Hi
5	Ch 2 Out Gnd
6	Ch 1 Out Lo
7	Ch 4 In Hi
8	Ch 4 In Gnd
9	Ch 3 In Lo
10	Ch 2 In Hi
11	Ch 2 In Gnd
12	Ch 1 In Lo
13	nc
14	Ch 4 Out Lo
15	Ch 3 Out Hi
16	Ch 3 Out Gnd
17	Ch 2 Out Lo
18	Ch 1 Out Hi
19	Ch 1 Out Gnd
20	Ch 4 In Lo
21	Ch 3 In Hi
22	Ch 3 In Gnd
23	Ch 2 In Lo
24	Ch 1 In Hi
25	Ch 1 In Gnd

**Table B-2 AUDIO I/O 5-9 Connector Pinout**

<b>Pin</b>	<b>Signal</b>
1	Ch 8 Out Hi
2	Ch 8 Out Gnd
3	Ch 7 Out Lo
4	Ch 6 Out Hi
5	Ch 6 Out Gnd
6	Ch 4 Out Lo
7	Ch 8 In Hi
8	Ch 8 In Gnd
9	Ch 7 In Lo
10	Ch 6 In Hi
11	Ch 6 In Gnd
12	Ch 5 In Lo
13	nc
14	Ch 8 Out Lo
15	Ch 7 Out Hi
16	Ch 7 Out Gnd
17	Ch 6 Out Lo
18	Ch 5 Out Hi
19	Ch 5 Out Gnd
20	Ch 8 In Lo
21	Ch 7 In Hi
22	Ch 7 In Gnd
23	Ch 6 In Lo
24	Ch 5 In Hi
25	Ch 5 In Gnd

**Table B-3 AUDIO I/O 9–12 connector pinout**

<b>Pin</b>	<b>8-Channel Signal</b>	<b>12-Channel Signal</b>
1	Aux 4 Out Hi	Ch 12 Out Hi
2	Aux 4 Out Gnd	Ch 12 Out Gnd
3	Aux 3 Out Lo	Ch 11 Out Lo
4	Aux 2 Out Hi	Ch 10 Out Hi
5	Aux 2 Out Gnd	Ch 10 Out Gnd
6	Aux 1 Out Lo	Ch 9 Out Lo
7	Aux 4 In Hi	Ch 12 In Hi
8	Aux 4 In Gnd	Ch 12 In Gnd
9	Aux 3 In Lo	Ch 11 In Lo
10	Aux 2 In Hi	Ch 10 In Hi
11	Aux 2 In Gnd	Ch 10 In Gnd
12	Aux 1 In Lo	Ch 9 In Lo
13	nc	nc
14	Aux 4 Out Lo	Ch 12 Out Lo
15	Aux 3 Out Hi	Ch 11 Out Hi
16	Aux 3 Out Gnd	Ch 11 Out Gnd
17	Aux 2 Out Lo	Ch 10 Out Lo
18	Aux 1 Out Hi	Ch 9 Out Hi
19	Aux 1 Out Gnd	Ch 9 Out Gnd
20	Aux 4 In Lo	Ch 12 In Lo
21	Aux 3 In Hi	Ch 11 In Hi
22	Aux 3 In Gnd	Ch 11 In Gnd
23	Aux 2 In Lo	Ch 10 In Lo
24	Aux 1 In Hi	Ch 9 In Hi
25	Aux 1 In Gnd	Ch 9 In Gnd

nc = unused pin



**Table B-4 10/100 BASE T (Ethernet, TCP/IP)**

Pin	Signal
1	T2
2	T1
3	R2
4	n/c
5	n/c
6	R1
7	n/c
8	n/c

**Table B-5 CP-2 Control Panel**

Pin	Signal
1	Gnd
2	Tx+
3	Tx-
4	V+

**Table B-6 CP-2 Cable Wiring**

E-2 end TA4M pins	CP-2 end A5F pins
1	1 + 5
2	2
3	3
4	4



## Appendix C: Specifications

<b>Audio</b>	
<b>Analog</b>	12 inputs, 12 outputs
<b>Digital Optical ADAT</b>	8 inputs, 8 outputs 16-Channel mode: 8 additional I/O channels using <b>LINK</b> connectors
<b>Gain</b>	Unity
<b>Sample Rate</b>	<b>Analog:</b> 48 kHz <b>Digital:</b> 48 or 44.1 kHz (synchronizes to input)
<b>Bit Depth</b>	24 bit
<b>Audio Latency</b>	2 ms
<b>Frequency Response</b>	10 Hz – 22 kHz, $\pm 0.0075$ dB
<b>Output Noise</b>	-125 dBFS (20 Hz – 20 kHz), -128 dBAFS
<b>Distortion</b>	-125 dBFS
<b>Linking</b>	Up to eight units can be linked into one system in an optical ring network
<b>Connectors</b>	
<b>Audio</b>	<b>Analog:</b> DB-25 wired to TASCAM digital audio pinout <b>ADAT:</b> Optical
<b>Control</b>	<b>Control Panel (CP-2):</b> Four-pin mini-XLR female <b>4 x RJ45:</b> Four-port internal switch for network <b>Linking:</b> ADAT optical, reassigned for audio I/O in 16-channel mode
<b>Power</b>	
<b>Connector</b>	Coaxial with locking collar, 5.5 mm o.d., 2 mm i.d.
<b>Electrical</b>	Nominal 12 VDC, 1.5 A maximum; accepts 12–24 VDC, either polarity, or 9–18 VAC
<b>External Supply</b>	<b>Input:</b> 100–240 VAC, 50–60 Hz, 30 W <b>Output:</b> 15 VDC, 2 A <b>Approved:</b> UL, CE
<b>Dimensions</b>	1RU <b>H</b> = 1.75 in (4.5 cm) <b>D</b> = 8.3 in (21 cm) <b>W</b> = 8.75 in (22.2 cm)
<b>Weight</b>	3.5 lb (1.6 kg) 7 lb (2.5 kg) in shipping box with power supply

