



ENGLISH

CLAY PAKY BEAM

ALPHA BEAM 1500 | 700 | 300
SHARPY



www.claypaky.it



TABLE OF CONTENTS

WHAT IS A CLAY PAKY BEAM?	4
WHAT THEY SAY ABOUT THE CLAY PAKY BEAM	5
HOW TO CHOOSE THE RIGHT BEAM	6
WHY USE A CLAY PAKY BEAM?	7
ALPHA BEAM 1500	12
ALPHA BEAM 700	16
ALPHA BEAM 300	20
SHARPY	24
TECHNICAL SPECIFICATIONS	28



WHAT IS A CLAY PAKY BEAM?

ACL projectors with their tight, narrow beams have long been a mainstay of Rock'n'Roll shows. Originally the simplest of beams, they were gradually enhanced over the years with various types of accessories and improvements. But the arrival of ever more advanced moving lights on the scene seemed to spell the end of the old-fashioned ACL effect.

And yet, Clay Paky, always attuned to the latest trends on stage, sensed that there was a nostalgic yearning among designers for this classic Rock'n'Roll effect and decided to rethink the ACL in a modern format. This was how the Beam was born.

The name we gave this new type of product was a clear declaration of our mission. The Beam wouldn't be a spotlight for projecting graphical images onto surfaces; nor would it be a washlight used to cast an even light onto surfaces and objects. Instead our attention was on the beam of light itself, on how it would appear in mid-air, and above all how it could be shaped and molded to create special aerial effects.

That goal led us to design a completely new type of optic, fundamentally different from any made for spots or wash lights before. The Beam became a new category of moving light. Although based on the same light

sources used by other moving projectors, the Beam's optics are designed to concentrate as much power as possible into a thick, 'solid' beam of light.

Clay Paky Beams maintain the same features offered by other Alpha moving lights: from colors and dimmers to gobos and frost filters that soften and shape the beam. And, to satisfy various demands, Clay Paky created not just one, but a whole series of Beam models, differentiated by power and complexity – making the range an incredibly versatile set of instruments. Brilliant at creating beams, they're equally comfortable taking on spot- and washlighting duties

alongside other lights on the rig.

Clay Paky's reputation for quality is evidenced in a number of features: the chromatic purity of the beam, the speed and softness of the mechanical movements, the clarity and sharpness of the effects, and above all the rock solid reliability.

What they say about the Clay Paky Beam

I am a big fan of the Alpha Beam; it has brought the ACL feel back into shows with colour, beams and movement thrown in for good measure...a lighting designer's dream!
Dave Hill, lighting designer

The Clay Paky Alpha Beam range has brought a unique new tool to long throw applications and has re-energised the air and atmosphere around many TV and live events.
Durham Marengi, lighting designer

The Clay Paky Beam is a perfect unit when you need a bit of extra push!
Paule Constable, lighting designer

The Alpha Beams allow me to use 50% of the number of regular spot fixtures. So if I had 100 spot fixtures I would aim for 50 Beams... The Beam has become a light that I cannot design a show without.
Baz Halpin, lighting designer

The Clay Paky Beams were tremendous, adding brilliant punches of colour big enough for one of the biggest landmark events in one of the most famous locations in the world.
Jerry Appelt, LD for Victory Day Parade in Moscow and Eurovision Song Contest

The Alpha Beam 1500 blew away the 4K unit we were testing it against at the shoot-out. Optically, the 1500W beam turned out to be more visible than the 4000W beam!
Koert Vermeulen, LD for Singapore Youth Olympic Games

I am a big ACL guy, and the Clay Paky Beams are stunning for that purpose. The speed of movement, color change and gobos is incredible. This is one of the most impressive lights that I have used in a long time.
Cosmo Wilson, lighting designer

Seeing so much light leave such a small unit, with so few watts compared to other lights on the stage, is really surprising.
Giovanni Pinna, lighting designer

The Clay Paky Alpha Beams are the most complete products in the ACL category because they have everything: great power, a wide range of effects, high speed movement.
Mariano De Tassis, lighting designer

I was blown away by the Alpha Beams. They are just so tight; they can always be clearly seen. In that sense you get more value out of them.
Daniel Bocking, lighting designer

Clay Paky Alpha Beam 700 is not just a normal machine - it is a BOMB - a light cannon! Much more powerful than a Xenon search light. What a wonderful, sexy machine!
Roger Bakhos, lighting designer

The Clay Paky beams are astonishingly bright and so versatile. They really made the show.
Roger Williams, LD for Tonight's the Night show at BBC

[...] they're an exciting new addition to the lighting designer's palette.
Chris Kempton, LD for Friday Night with Jonathan Ross at BBC

Don't be fooled by the Sharpy's small package I was lighting up buildings across the highway with these fixtures!
Steve Lieberman, LD for Ultra Music Festival

Sharpy units are unbelievably fast. They have a 'mirror-like' speed combined with the organic elements of a moving head.
Rohan Thornton, lighting designer

The Sharpy definitely provided the bang for the buck. We used to be amazed when the Alpha 300 first came out; and now here's the Sharpy putting out much more light using just half the power - it's ridiculously bright.
Tim Routledge, lighting designer

They deliver all those beam effects and everything you need to get that extra layer that really punches through.
Eric Wade, lighting designer and programmer

The Sharpy's tracer beams made a powerful impact, and indeed in some ways they gave more effective results than the Showguns installed along side.
Markus Kromer, LD for a private company party at the Festhalle Frankfurt.

The light output from such a small package is amazing! The Sharpy's fast speed of movement is breathtaking! The lamps were small and discreet enough not to draw the eye in the set, but the effect they produced was gigantic!
Lee Allen, lighting designer

Magazine Reviews

This is the type of output normally seen with Xenon fixtures, not sub-200W lamps that could pass as carry-on luggage.
Patrick Dierson, Live Design Online, February 2011 - Sharpy test

Clay Paky in their turn have done a good job of optical design to provide as narrow a beam as I've seen for some time.
Mike Wood, Lighting & Sound America, March 2011 - Sharpy test

What was really impressive... the speed of the fixture. The Sharpy is SUPER fast with it's pan and tilt. It's so fast it almost hurts to watch the fixture move.
Justin Lang, iSquint.net, March 2011 Sharpy test

Sharpy is a miniature Beam Light providing extreme power without compromise. Its production and engineering quality is of the highest level and its optical quality sets a new benchmark.
Production Partner, March 2011, Sharpy test

Sharpy projects an extremely bright, sharp and narrow beam with less electricity, yet no compromise to the quality of the projection.
Douglas Cole, Sound & Lite, March/April 2011

I have to admit this fixture is the closest I have ever seen a yoke light move to a mirrored fixture. [...] It is indeed the new age equivalent of a PAR 46 ACL beam on steroids.
Nook Schoenfeld, PLSN, June 2011, Sharpy test

Clay Paky has most certainly been the most innovative lighting manufacturer in recent times, and now has done it all again with Sharpy.
Paul Collison, AV Magazine, issue n°16

Clay Paky pioneered the Beam concept with this 300W concept that immediately became a landmark. The whole fixture is an innovation, delivering standard features with an extremely bright output for its class.
Grégory Macé, Sono Magazine, March 2010

As it is, the Alpha Beam 300 is a "searchlight in miniature", but with many more features. Let's say it from the start: the amount of light coming out of it is extraordinary.
Walter Wehrhan and Detlef Hoepfner, Production Partner, May 2008

It's light, bright, tight, really fast, and dead quiet. It's not a generic moving light, but if you have the right application for it the Alpha Beam will certainly do the job and then some. I really like it.
Jimmy D., CX Magazine, October 2009 Alpha Beam 300 test

[...] We are witnessing the start of a new fixture generation, providing designers with new creative opportunities
Alfio Morelli, Sound & Lite, May-June 2008 Alpha Beam 300 test

HOW TO CHOOSE THE RIGHT BEAM

Beams can be used in a number of ways depending on the application. An important factor to consider is the size of the stage. In large arenas for example, beam diameter becomes just as significant as output, if audiences are to see the beam properly.

Another factor to consider is the speed of movement, which is faster the smaller the fixture. In order to meet a range of applications, Clay Paky has produced a broad range of Beam models, the broadest of any manufacturer. The fixtures are differentiated not only by lamp power, but by different optical systems capable of producing a wide variety of effects and projections.

Generally speaking the higher the wattage, the larger the fixture and the greater the cost. To justify the added cost, we incorporated a number of effects into the larger Beam projectors that make them multi-functional instruments, equally capable of spot-lighting and washlighting. The general rule is, the higher the wattage, the wider the set of features and effects.

The following comparison table is intended as a quick guide comparing the main beam characteristics of the various Beam models.

	BEAM 1500	BEAM 700	BEAM 300	SHARPY
DIMENSIONS mm (inches)				
WEIGHT kg (lbs)	40 (88.2)	20.8 (45.9)	19.1 (42.1)	16 (35.3)
BEAM DIAMETER mm (inches)	240 (9.5)	195 (7.7)	195 (7.7)	146 (5.8)
NATURAL BEAM OPENING	4.2°	6.6°	8°	3.8°
MINIMUM BEAM OPENING (*)	1.1°	0.7°	2.5°	0.1°
NOMINAL LAMP POWER (Watt)	1,500	700	300	189
POWER CONSUMPTION (VA at 230V 50Hz)	2,000	1,050	550	350
1,000 lux at... m (feet)	134 (440)	100 (328)	57 (187)	154 (505)
500 lux at... m (feet)	190 (623)	141 (463)	81 (266)	218 (715)

(*) using the built-in beam angle reduction device

WHY USE A CLAY PAKY BEAM?

The Beam's tight parallel beams show up extremely well on stage - even the type of modern stages that are usually awash with high intensity LEDs.



With their slick and speedy movements, Beams bring energy and dynamism to TV and live shows recalling the rapid behavior of moving mirror fixtures.



The Beam creates a thick column of light, visible even without the aid of fog or haze, which can then be crafted into various shapes and sizes.



Beams are instruments for helping to define space, wrapping the stage in a curtain of light, or extending the space with lines of light that reach out beyond the scope of the stage.

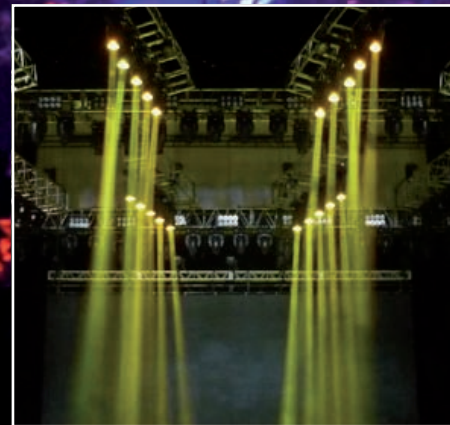



Beams bring a distinctive new look to stages, creating a powerful impact on audiences. They can be used to simulate massive laser beams or create feathery little wisps of light.



The Beam concept allows light to reach previously unimaginable distances - not only as parallel shafts of light, but - with the aid of the frost - as a highly effective wash light.

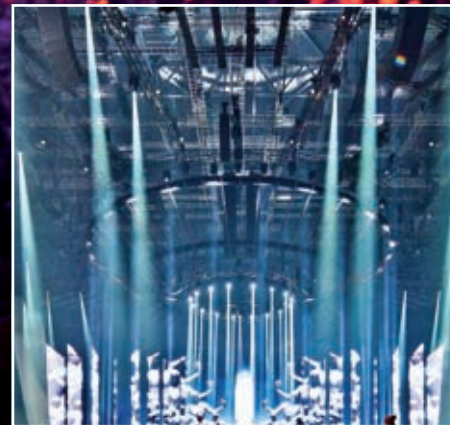
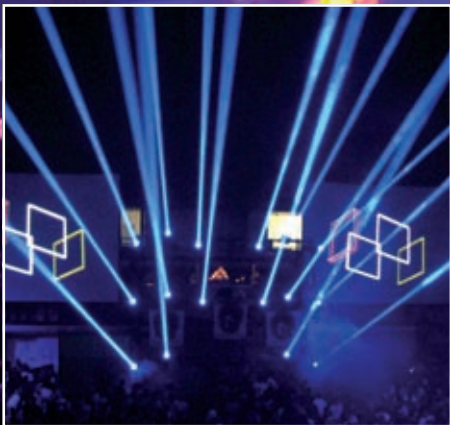



Beams are particularly awe-inspiring effects when arranged and synchronized in clusters of 3,4, or more units.



The Beam combines the retro charm of an ACL with the advanced feature set of modern moving lights.





Beams fill the stage with their presence - to such a degree that designers find they need fewer fixtures overall.

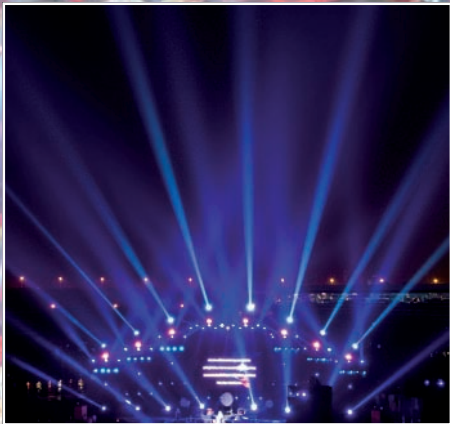

Beams can be used as sky tracers, but with added color and speed of movement.



Beams are incredibly versatile - brilliant at creating interlocking beams of light, and just as effective as a soft edge backlight.





BEAM 1500

The leading light of large events

The Alpha Beam 1500 is the most powerful luminaire within the category of fully automated ACL fixtures. It generates a solid, super-concentrated parallel beam for very long-throw projections, and includes numerous features for shaping, coloring and animating

the beam, creating spectacular mid-air effects. Featuring the new Fast-Fit 1500W lamp, Alpha Beam 1500 functions as a spotlight for long distance, focused projections as well as an excellent narrow-angle washlight.

- + Optical unit with extremely high luminous efficiency (185,000 lux at 10 m)
- + 1500W Lok-it discharge lamp
- + Extraordinarily wide, fast and linear pan and tilt movements
- + Narrow and parallel 4° beam
- + CMY color system + color wheel (including CTO)
- + 3 rotating prisms (5-facets, 6-facets, comet effect)
- + 14 gobos (for pattern and beam size)
- + Electronic focusing, for projecting sharp images at any distance
- + Frost effect (light/medium/heavy) on dedicated channels
- + High speed mechanical iris
- + Hybrid dimmer (100-50% electronic; 50% to zero mechanical)
- + Eco-friendly: may be used instead of very much larger and more expensive searchlights
- + New generation, high performance electronics
- + Modular construction for easy maintenance

WHERE TO USE IT

With its massive 8-inch (20cm) thick beam, the Alpha Beam 1500 is particularly visible at very great distances, making it a suitable Beam for large-scale spectacles such as sporting events, national celebrations and stadium rock shows.

The Alpha Beam 1500 makes an excellent replacement for expensive sky tracers, but

with even better performance and features, offering innumerable colors and spectacular aerial animations.

As the most versatile tool in Clay Paky's arsenal of Beams, the 1500 also doubles up as an effective Spot or Wash light.

TECHNICAL FEATURES

POWER SUPPLY
200 - 240V 50/60Hz

INPUT POWER
2,000VA at 230V 50Hz (PFC electronic ballast)

LIGHT SOURCE
1500W discharge lamp:
- Type: Osram Lok-it 1500W
- Cap: PGJ50
- Color temperature: 6,000 K
- Luminous flux: 135,000 lm
- Average life: 750 h

CHANNELS
Max 28 DMX 512 control channels

MOVING BODY
Angle: - PAN = 540° - TILT = 252°

ELECTRONICS
Long life self-charging buffer battery.
Firmware Upgrade with no power
Firmware upload from another fixture

WORKING POSITION
Functions in any position.
Hanging system: with fast-lock omega clamps
(1/4 turn) on the base

MARKING AND APPROVAL
In conformity with the European Union Low Voltage Directive 2006/95/CE and Electromagnetic compatibility Directive 2004/108/CE.
This product is cETLus Listed Mark, and complies with the UL 1573 and CSA C22.2 No. 166 standards.

STANDARD ACCESSORIES

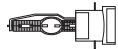

HTI 1500W/60/P50 LOK-IT (6.000 K)
OSRAM LAMP
code: L10102

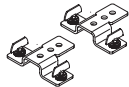

OMEGA
for fixing clamps
code: 183102/802

OPTIONAL ACCESSORIES



CLAMPS
48-51mm, max 300 Kg hook for truss
code: C21070



SAFETY CABLE
Ø 4mm, length 680mm
code: 105041/003

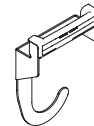

HANDLES SET
code: C61182

FOAM SHELL
code: F21176

ROXTER-CASE
(including 1 foam shell)
for 1 Alpha 1500
code: F21210

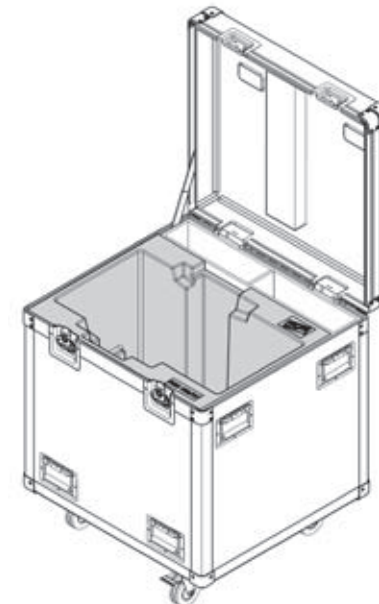

ALPHA BEAM 1500
code: C61310



WEIGHT AND DIMENSIONS

■ 40 Kg (88.18 lbs)

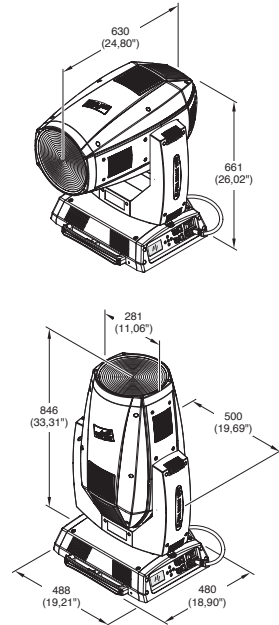

ROTATING GOBOS

Ø 37.5 mm



084618/001 084619/001 084620/001 084621/001



084622/001 084623/001

FIXED GOBOS

Ø 31.5 mm



085910/001 085801/001 085802/001 085606/001



085603/001 085909/001 084702/001 085601/001

COLOR WHEEL

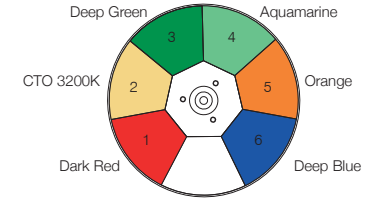

CMY

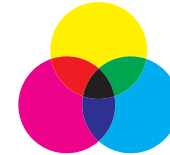

PHOTOMETRICS

Standard (4.2°)

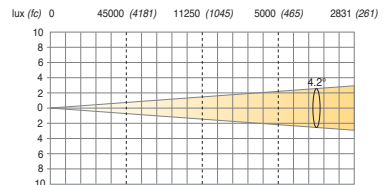

with Heavy Frost (5.2° 50% - 11.3° 10%)

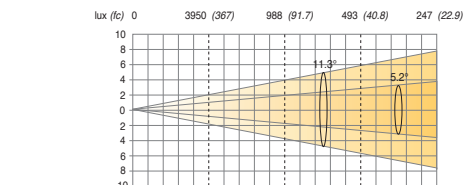

with Ovalizer filter (X and Y axis)

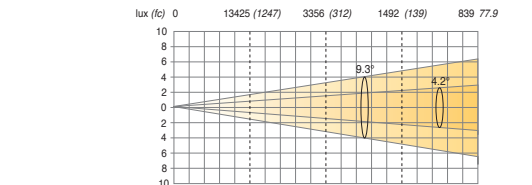



© photo: Ralph@Larmann.com

2011 Eurovision Song Contest



200 Years of Mexico



Commonwealth Games, India



Victory Day, Moscow



Pietro e Lucia Opera Rock, Czech Republik

ALPHA BEAM 1500
SELECTED REFERENCES



BEAM 700

A compact blend of features, power and speed

Using just 700W in power, the Alpha Beam 700 creates highly visible beams that show up extremely well even on the brightest sets and stages. It is extremely compact in relation to its power and rich set of features.

The Beam 700 is highly regarded for its fluidity and rapid speed of movements. Its rotating gobos and prism allow for beautiful mid-air animations; and a frost and focus add to the 700's all-round versatility.

- + Optical unit with extremely high luminous efficiency (100,000 lux at 10 m)
- + 700W Mini-FastFit discharge lamp
- + Incredibly compact for a 700W light (head length = 435 mm) + lightweight (20 kg)
- + Extraordinarily wide, fast and linear pan and tilt movements
- + Narrow and parallel 6,6° aperture beam
- + CMY color system + color wheel, including CTO and CTB filters
- + 1 rotating prism + 15 gobos (for pattern and beam size)
- + Hybrid dimmer (100-50% electronic; 50% to zero mechanical)
- + Electronic focusing, for projecting images even at great distances
- + Frost effect on a dedicated channel
- + High speed mechanical iris
- + Silent operation
- + New generation, high performance electronics
- + Eco-friendly: may be used instead of higher wattage and more expensive spotlights
- + Modular construction for easy maintenance
- + Half power mode (400W)

WHERE TO USE IT

The Alpha Beam 700 is positioned right at the center of the Clay Paky Beam range making it one of the most adaptable instruments, suited to a very wide range of applications. It is ideal for Touring and Corporate Events, where its compact size and low consumption really pay dividends.

It has also become one of the mainstays of larger television studios and outdoor broadcasts. Above all, the Alpha Beam 700 is a tireless industry workhorse, a risk-free investment offering fantastic ROI.



chrome-plated version
available on request



IP20 t_c 150°C t_a 40°C 700W \varnothing 7.5m

TECHNICAL FEATURES

POWER SUPPLY

200 - 240V 50/60Hz
100 - 120V 50/60Hz
Automatic power supply switching

INPUT POWER

1,050VA at 230V 50Hz (PFC electronic ballast)

LIGHT SOURCE

700 W discharge lamp:
- Type: Philips MSR Gold 700/2 MiniFastFit
- Cap: PGjX28
- Color Temperature: 7,200 K
- Fluminous Flux: 50,000 lm
- Average Life: 750 h

CHANNELS

Max 26 DMX 512 control channels

MOVING BODY

Angle: - PAN = 540° - TILT = 252°

ELECTRONICS

Long life self-charging buffer battery
Firmware upgrade with no power
Firmware upload from another fixture

WORKING POSITION

Functions in any position
Hanging system: with fast-lock omega clamps
(1/4 turn) on the base

MARKING AND APPROVAL

In conformity with the European Union Low Voltage Directive 2006/95/CE and Electromagnetic compatibility Directive 2004/108/CE.
This product is cETLus Listed Mark, and complies with the UL 1573 and CSA C22.2 No. 166 standards.

STANDARD ACCESSORIES

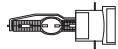

MSR GOLD 700W/2 MINI-FAST-FIT (7,200 K)
PHILIPS LAMP
code: L10098

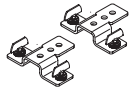

OMEGA
for fixing clamps
code: 183102/802

OPTIONAL ACCESSORIES



CLAMPS
48-51mm, max 300 Kg hook for truss
code: C21070



SAFETY CABLE
Ø 4mm, lenght 680mm
code: 105041/003

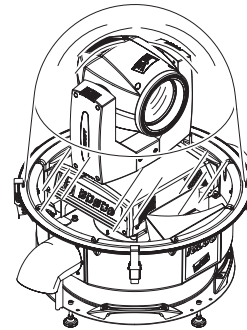

IGLOO
IP54 fully outdoor enclosure
code: C61195

FOAM SHELL
code: F21172

ROXTER-CASE
(including 2 foam shell)
for 2 Alpha 700 / 300
code: F21205

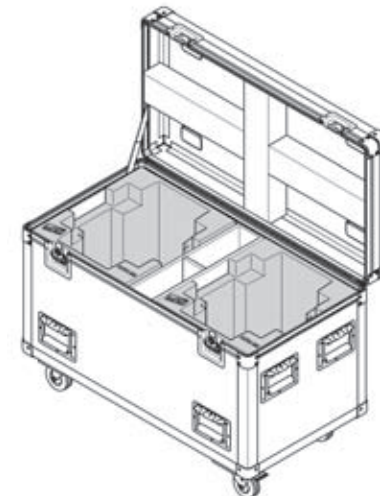

ALPHA BEAM 700
code: C61360



WEIGHT AND DIMENSIONS

■ 25.8 Kg (45.86 lbs)

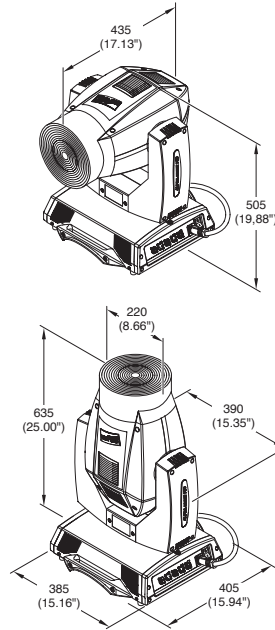

ROTATING GOBOS

Ø 25.7 mm

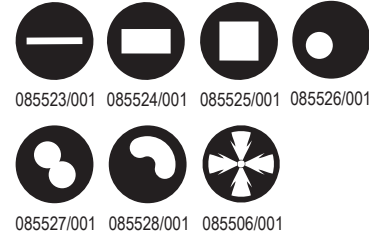

FIXED GOBOS

Ø 31.5 mm

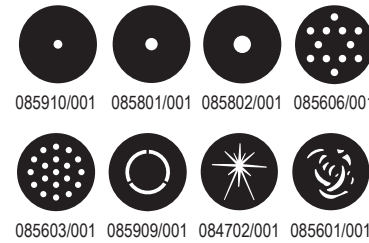

COLOR WHEEL

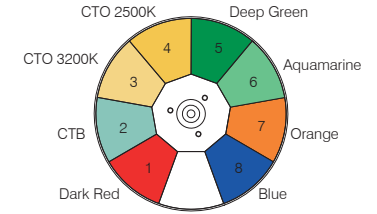

CMY

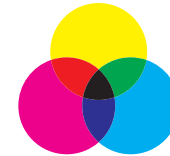

PHOTOMETRICS

Standard (6.6°)

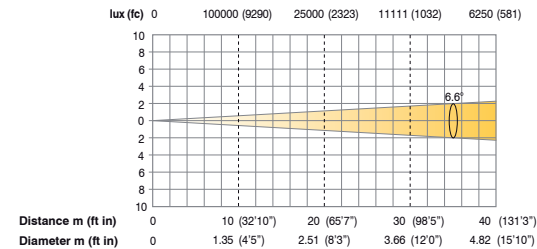

In "Half-Power mode" the luminosity is 60% of the above values

with Frost (6.7° at 50% - 15.6° at 10%)

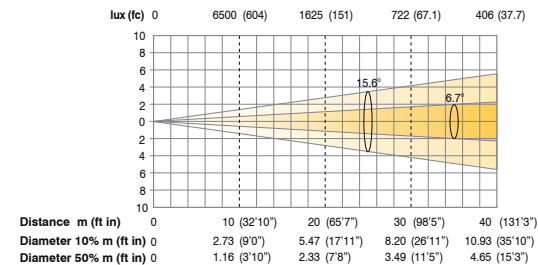

In "Half-Power mode" the luminosity is 48% of the above values



Osterleuchten, Kalkriese Park Museum



Deep Purple



Sanremo Festival, RAI TV



Tonight the Night, BBC



Ligabue



Friday Night with Jonathan Ross, BBC

ALPHA BEAM 700
SELECTED REFERENCES



WINNER OF THE
plasa2008
AWARDS OF INNOVATION

BEAM 300

Extraordinary in small environments

Alpha Beam 300 uses a 300W light source to produce a slender, parallel beam which can be infinitely molded and colored in a variety of forms. Awarded for technological innovation in 2008, the 300 is highly regarded for its low weight and tiny footprint.

- + The first and original "beam moving light" on the market
- + Optical unit with extremely high luminous efficiency (33,000 lux at 10 m)
- + 300W Mini-FastFit discharge lamp
- + Natural 8° beam angle
- + CMY color system + color wheel, including CTO and CTB filters
- + 8 fixed gobos supplied as standard (4 image gobos + 4 beam angle reduction gobos)
- + Innovative patented linear frost effect
- + 0-100% mechanical dimmer
- + Wide and quick pan and tilt movements
- + Silent operation
- + Extremely new design high performance electronics
- + Eco-friendly: may be used instead of very much larger and more expensive spotlights
- + Electronic ballast fitted as standard
- + Modular construction for easy maintenance

WHERE TO USE IT

The first in the Beam family, the Alpha Beam 300 offers the best possible price per performance ratio. It's an excellent solution for television studios where light weight and low power consumption are paramount. Those same characteristics

make the Alpha Beam 300 ideal for fixed installations such as entertainment venues and themed environments as well as for smaller performances.



chrome-plated version
available on request



TECHNICAL FEATURES

POWER SUPPLY

200 - 240V 50/60Hz
100 - 120V 50/60Hz
Automatic power supply switching

INPUT POWER

550VA at 230V 50Hz (PFC electronic ballast)

LIGHT SOURCE

300W discharge lamp:
- Type: MSR Philips Gold 300/2 FastFit
- Cap: PGjX28
- Color Temperature: 9,300 K
- Luminous flux: 22,000 lm
- Average lamp: 750 h

CHANNELS

Max 18 DMX 512 control channels

MOVING BODY

Angle: - PAN = 540° - TILT = 252°

ELECTRONICS

Long life self-charging buffer battery
Possibility to upgrade the software
through the DMX 512 input.

WORKING POSITION

Functions in any position
Hanging system: with fast-lock omega clamps
(1/4 turn) on the base

MARKING AND APPROVAL

In conformity with the European Union Low Voltage Directive 2006/95/CE and Electromagnetic compatibility Directive 2004/108/CE.
This product is cETLus Listed Mark, and complies with the UL 1573 and CSA C22.2 No. 166 standards.

STANDARD ACCESSORIES

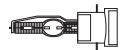

MSR GOLD 300W/2 MINI-FAST-FIT (9,300 K)
PHILIPS LAMP
code: L10087

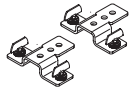

OMEGA
for fixing clamps
code: 183102/802

OPTIONAL ACCESSORIES



CLAMPS
48-51mm, max 300 Kg hook for truss
code: C21070



SAFETY CABLE
Ø 4mm, length 680mm
code: 105041/003

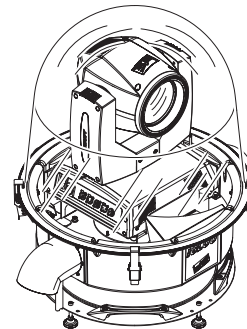

IGLOO
IP54 fully outdoor enclosure
code: C61195

FOAM SHELL
code: F21172

ROXTER-CASE
(including 2 foam shell)
for 2 Alpha 700 / 300
code: F21205

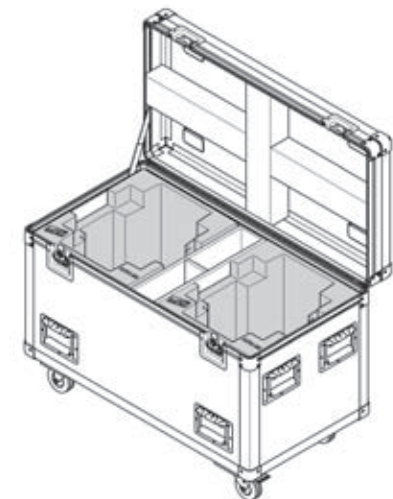

ALPHA BEAM 300
code: C61093



WEIGHT AND DIMENSIONS
■ 19.1 Kg (42.11 lbs)

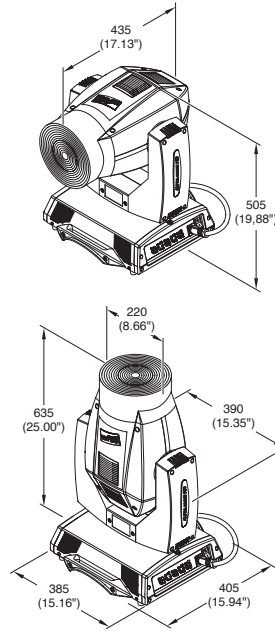

FIXED GOBOS
Ø 31.5 mm

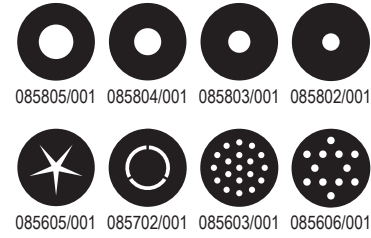

COLOR WHEEL

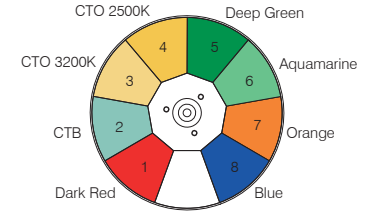

CMY

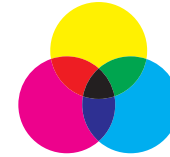

PHOTOMETRICS

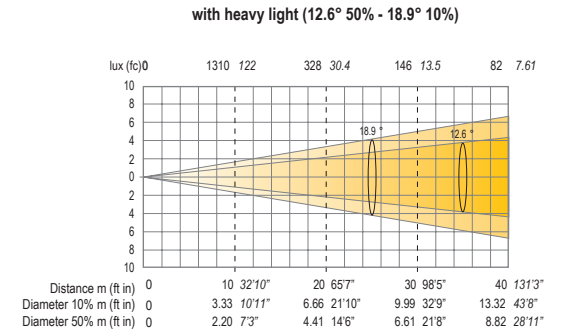
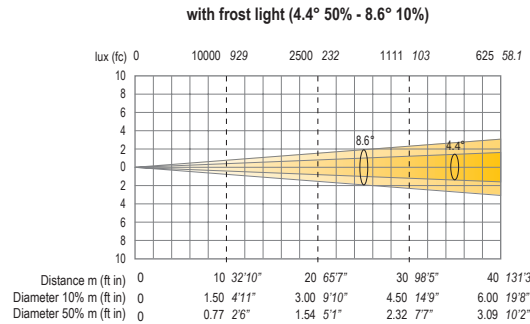
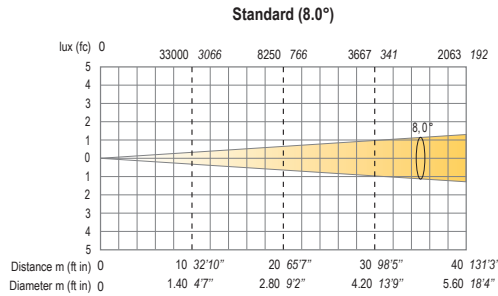



Tina Turner world tour



AC/DC world tour



Quelli che il Calcio, RAI TV



lo Carnò, Mediaset TV



Royal Albert Hall: Mounbatten Festival

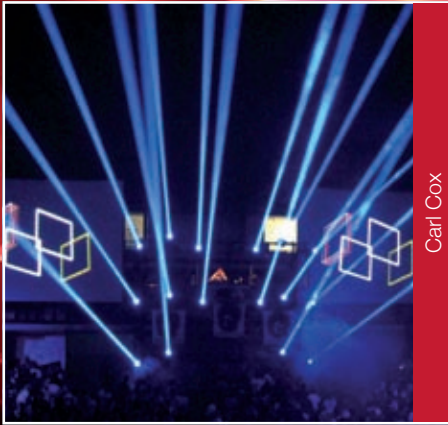

Carl Cox



RMJ Festival, Finland



ALPHA BEAM 300
SELECTED REFERENCES



WINNER OF THE
plasa2010
AWARDS OF INNOVATION

LDI
2010
HONORABLE MENTION
as Best Debating Lighting Product

LIVE DESIGN
PRODUCTS
2010-2011 OF THE YEAR

SHARPY

Record-breaking speed, power and performance

It's probably no exaggeration to say that no moving light has ever enjoyed such immediate success as the Sharpy. Winning instant acclaim and a string of awards, the Sharpy stunned the industry for the unprecedented amount of light it manages to squeeze out of a 189W lamp. The unit produces a perfectly parallel beam of light capable of matching

beams made by 1500W fixtures. Compact at 50cm tall, and weighing just 16kg, Sharpy's incredibly rapid movements recall the speed of moving mirror fixtures. The unit delivers an unusually crisp, laser-like beam – free of any halation and discoloration around the edges, while the beam retains its narrow shape even at great distances.

- + 189W Platinum 5R discharge lamp
- + Unprecedented brightness – comparable to wattages many times higher (59,760 lx at 20m)
- + Perfectly parallel, laser-like beam, sharply defined and free of any halo
- + Adjustable beam angle from 0 to 3.8°
- + Interchangeable color wheel with 14 fixed colors
- + Interchangeable gobo wheel with 17 fixed gobos
- + 8-facet rotating prism
- + Electronic focusing
- + Mechanical dimmer
- + Frost Filter
- + Rapid and extensive pan and tilt movements
- + New, high-performance electronics
- + Patented Italian design
- + Small, lightweight and easily transported (only 48 cm x 16 kg)
- + Eco-friendly: replaces far larger and more expensive spotlights and searchlights
- + Electronic ballast fitted as standard

WHERE TO USE IT

Sharpy offers the purest example of the Beam concept, a perfectly parallel, narrow beam crisply defined in mid-air. This is a special effect that can be used in various ways according to the application. For large-scale spectacles, it can be used

splinters of light reminiscent of laser beams. In smaller environments, the Sharpy becomes the dominant force filling the stage with its presence. A truly innovative product that opens up for completely new creative ideas.



chrome-plated
and white versions
available on request



IP20

t_c100°C

t_a40°C

189W

∅12m

TECHNICAL FEATURES

POWER SUPPLY
115/230V 50/60 Hz

INPUT POWER
350VA at 230V 50Hz

LIGHT SOURCE
Discharge lamp with a short arc burner
in a reflector system
- Type: Philips MSD Platinum 5R
- Output Lamp power: 189W
- Color temperature: 8,000 K
- Luminous flux: 7,950 lm
- Average life: 2,000 h

CHANNELS
Max 20 DMX 512 control channels

MOVING BODY
Angle: - PAN = 540° - TILT = 252°

ELECTRONICS
Long life self-charging buffer battery
Firmware upgrade with no power
Firmware upload from another fixture

WORKING POSITION
Functions in any position
Hanging system: with fast-lock omega clamps
(1/4 turn) on the base

MARKING AND APPROVAL
In conformity with the European Union Low Voltage Directive 2006/95/CE and Electromagnetic compatibility Directive 2004/108/CE.
This product is cETLus Listed Mark, and complies with the UL 1573 and CSA C22.2 No. 166 standards.

STANDARD ACCESSORIES

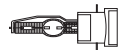

MSD PLATINUM 5R (8000 K)
PHILIPS LAMP
code: L10103

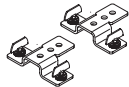

OMEGA
for fixing clamps
code: 183102/802

OPTIONAL ACCESSORIES



CLAMPS
48-51mm, max 300 Kg hook for truss
code: C21070



SAFETY CABLE
Ø 4mm, length 680mm
code: 105041/003



HEAT SCREEN
code: C61190

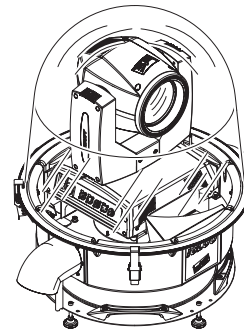

IGLOO
IP54 fully outdoor enclosure
code: C61195

FOAM SHELL
code: F21178

ROXTER-CASE
(including 4 foam shell)
for 4 Sharpy
code: F21200

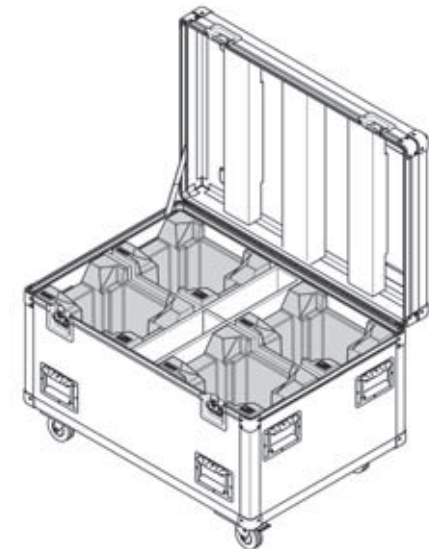

SHARPY
code: C61375



WEIGHT AND DIMENSIONS

■ 16 Kg (35.27 lbs)

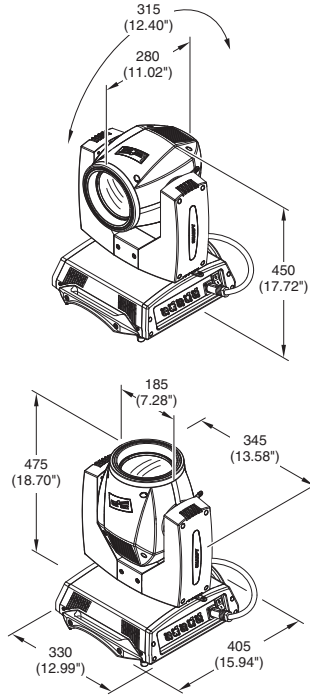

GOBO WHEEL

Other wheels are available on request

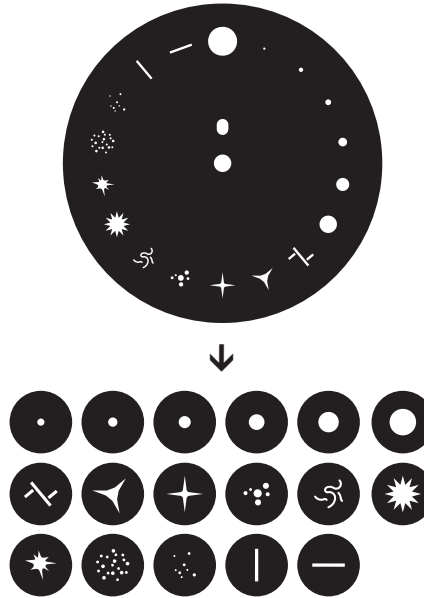

COLOR WHEEL

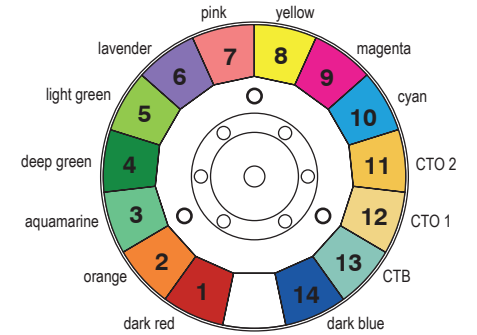

PHOTOMETRICS

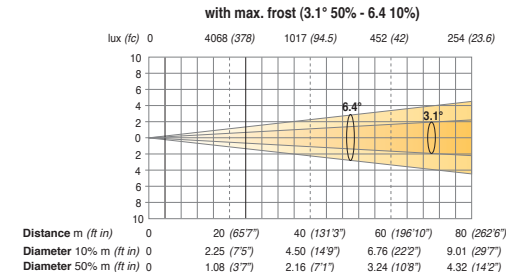
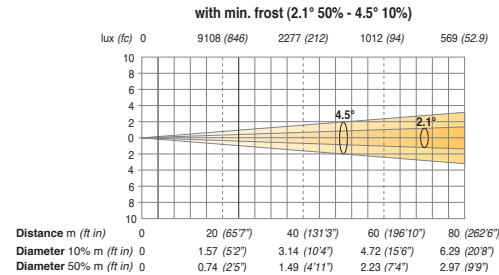
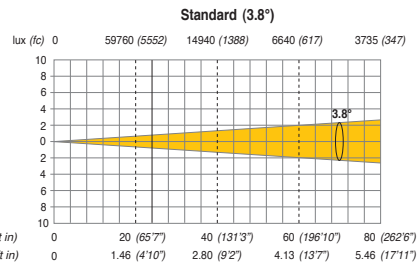

SHARPY

© photo: Ralph@Larmann.com



Eurovision Song Contest 2011

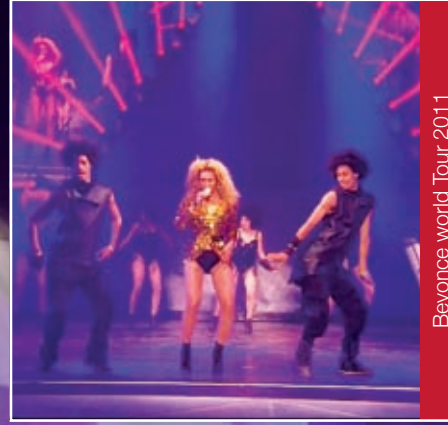

Beyoncé world Tour 2011



Paul McCartney world Tour 2011



Gretchen Wilson and Big & Rich



Huga Party Band at the Opera House, UK



Million Dollar Drop, Poland



Blue Peter, BBC



SHARPY
SELECTED REFERENCES

TECHNICAL SPECIFICATIONS	Alpha Beam 1500	Alpha Beam 700	Alpha Beam 300	Sharp
Lamp	1500W Lok-It	700W Mini-FastFit	300W Mini-FastFit	189W Platinum
- Color temperature (K)	6,000	7,500	9,300	8,000
- Luminous flux (lm)	135,000	50,000	22,000	7,950
- Average life (h)	750	750	750	2,000
- Socket	PGJ50	PGJX28	PGJX28	-
Power supply	200-240V (50/60Hz)	100-240V (50/60Hz)	100-240V (50/60Hz)	115/230V (50/60Hz)
Ballast	PFC Electronic	PFC Electronic	PFC Electronic	PFC Electronic
Power consumption	2,000VA (230V 50/Hz)	1,050VA (230V 50/Hz)	550VA (230V 50/Hz)	350VA (230V 50/Hz)
Electronic focusing	YES	YES	-	YES
CMY color mixing	YES	YES	YES	-
Colors on wheel	6+1	8+1	8+1	14+1
CTO filter	1 (3,200 K)	2 (3,200 K + 2,500 K)	2 (3,200 K + 2,500 K)	2 (3,200 K + 2,500 K)
CTB filter	-	1	1	1
Frost levels	3	3	1	1
Rotating gobos (indexable and interchangeable)	6	7	-	-
Fixed gobos (interchangeable)	8	8	8	wheel with 17 patterns
Rotating prism	3 (5 and 6 facets, comet effect)	1 (6 facets)	-	1 (8 facets)
Mechanical Iris	YES	YES	-	-
Beam Angle reduction devices	3	3	3	6
0-100% dimmer on a dedicated channel	hybrid	hybrid	mechanical	mechanical
Stop/strobe	YES	YES	YES	YES
DMX control channels	max 28	max 26	max 18	max 20
PAN 540° stnd/fast speed	4.3	3.2 / 2.9	3.2 / 2.9	2.4
TILT 252° stnd/fast speed	2.6	1.9 / 1.7	1.9 / 1.7	1.3
Fixed gobo change speed	0.140 sec (100 rpm)	0.140 sec (100 rpm)	n/a	0.095 sec (100 rpm)
Rotating gobo change speed	0.415 (150 rpm)	0.214 (180 rpm)	-	-
Prism insertion speed	0.754 sec (100 prm)	0.408 sec (120 prm)	-	0.357 sec (43 rpm)
Color change speed	0.201 sec (160 rpm)	0.146 sec (160 rpm)	n/a	0.127 sec (160 rpm)
0-100% CMY speed	0.396 sec	0.370 sec	n/a	-
0-100% Focus speed	2.977 sec	2.830 sec	-	1.111 sec
0-100% Iris speed	0.118 sec	0.127 sec (222 bpm)	-	-



2011 Eurovision Song Contest
Featuring Alpha Beam 1500
and Sharpy
© photo: Ralph@Larmann.com





Unser Star für Oslo, Germany
Featuring Alpha Beam 1500
© photo: Ralph@Larmann.com



www.claypaky.it

CLAY PAKY S.p.A.
I - 24068 Seriate (BG) - Via Pastrengo, 3/b
Phone +39 035 654311 - Fax +39 035 301876
cp.info@claypaky.it



UNI EN ISO 9001

