

# Diamond 4 Titan

## Operator's Manual

Version 3.0



Copyright Avolites Limited 2010

Useful Avolites phone numbers: -

Avolites England

Sales and service\* (+44) (0) 20 8965 8522

Service out of hours\* (+44) (0) 831 17 8888

Fax (+44) (0) 20 8965 0290

Email [name@avolites.com](mailto:name@avolites.com)

Website <http://www.avolites.com>

Distribution of Avolites products in USA: -

Avolites America

Sales and service\* (+1) 865 938 2057

Fax (+1) 865 938 2059

\*Before contacting Avolites for service enquiry please ensure that you have the product serial number and the Software version. The serial number can be found on the back of the desk near the power socket and on the keyboard drawer; the software version is displayed on the title bar of the Diamond application on the VDU.

The latest version of this manual and Diamond Software can be downloaded from the Avolites website.

**The small print :**

**No Liability for Consequential Damages**

Avolites has a policy of continuous product and documentation improvement. As such the detail within this manual may not match the operation of the Diamond 4.

In no event shall Avolites be liable for any direct, indirect, special, incidental, or consequential damages or loss whatsoever (including, without limitation, damages for loss of profits, business interruption, or other pecuniary loss) arising out of the use or inability to use the Diamond even if Avolites Ltd. has been advised of the possibility of such damages. Because some jurisdictions do not allow the exclusion or limitation of liability for consequential or incidental damages, the above limitation may not apply to you.

Avolites Ltd recognise that all trademarks within the manual are the property of their respective owners.

Reprint and revision history:

First produced Feb 2005

Revision 10/01/2007 Alex Triffitt

Revised for v2.2 29/02/08 Tim Mitchell

Revised for v2.3 12/06/08 Tim Mitchell

Revised for v2.4 14/7/08 Tim Mitchell

Revised for Titan v1.1 13/01/09 Tim Mitchell

Revised for v3.0 19/08/10 Tim Mitchell

Copyright Avolites Limited 2010

This manual was written by Tim Mitchell, Sabre Technology Ltd  
<http://www.sabretechnology.co.uk>

## TUTORIAL CONTENTS

---

1. WELCOME TO THE DIAMOND 4	9
2. PATCHING	19
3. CONTROLLING DIMMERS AND FIXTURES	29
4. PALETTES	37
5. SHAPES	41
6. CUES	45
7. CHASES	55
8. CUE LISTS	61
9. RUNNING YOUR SHOW	67
10. INTRODUCTION TO INTELLIGENT LIGHTING	69
11. INTRODUCTION TO AVOLITES CONSOLES	71
12. THE DIAMOND FOR AVOLITES EXPERTS	75

## REFERENCE MANUAL CONTENTS

---

1. SETTING UP THE CONSOLE	109
2. PATCHING	127
3. CONTROLLING DIMMERS AND FIXTURES	137
4. PALETTES	147
5. SHAPES	153
6. CUES	159
7. CHASES	173
8. CUE LISTS	185
9. RUNNING THE SHOW	197
10. TIMECODE PLAYBACK	203
11. USER SETTINGS AND OTHER OPTIONS	207
12. WORKING WITH FIXTURE PERSONALITIES	222
13. THE DIAMOND 4 PILOT	226
14. NETWORKING	228
15. GLOSSARY OF TERMS	244
WHAT'S NEW IN TITAN V3.0	250
INDEX	275

Copyright Avolites Limited 2010

**Diamond 4**  
**Tutorial**

Copyright Avolites Limited 2010

Copyright Avolites Limited 2010



# 1. Welcome to the Diamond 4

This manual is designed to help you get the most out of your Diamond 4 console. We have divided it into two sections.

- This first section is a tutorial which gives you a step by step guide of how to carry out the most common functions of the Diamond 4. If you are new to the console, working through this part will give you a good introduction.
- The second section is a reference manual which tells you everything there is to know about the Diamond 4.

To help you move between the two sections, we have made the chapter numbering the same, so if you are using the tutorial and you want more information, just look for the same chapter number in the reference manual.

This manual applies to the Diamond 4 Vision, Elite and Classic consoles. It doesn't apply to the earlier Diamond 2 and 3 consoles, but for simplicity we'll refer to the Diamond 4 consoles simply as "the Diamond". The manual refers to Diamond 4 Titan v3.0 software, features may be changed or added in later software.

## 1.1 Quick tour around the console

The Diamond console is big! In this first part we will give you a quick tour round the console so you know where to find things.

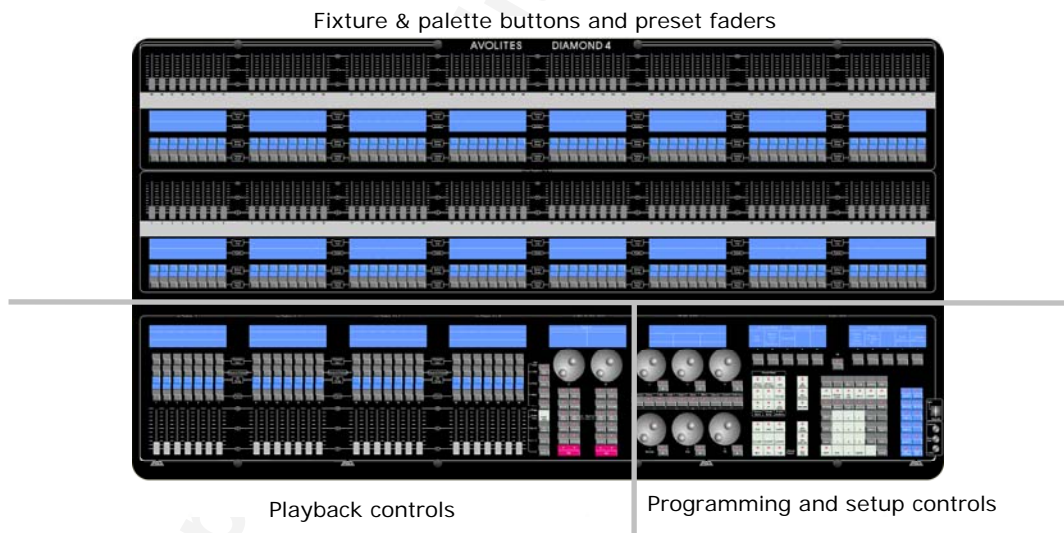

The console has three main areas.

The top half of the console has two rows of faders, buttons and displays for fixtures and palettes. You can also store cues, chases and cue lists in these faders and buttons. The Diamond Elite has only a single row of faders which can be allocated to either the upper or lower row of buttons and displays.

The bottom left of the console has the playback buttons and faders which are normally used for storing cues, chases and cue lists.

The bottom right of the console has all the programming and setup controls and displays.

## Programming and setup controls

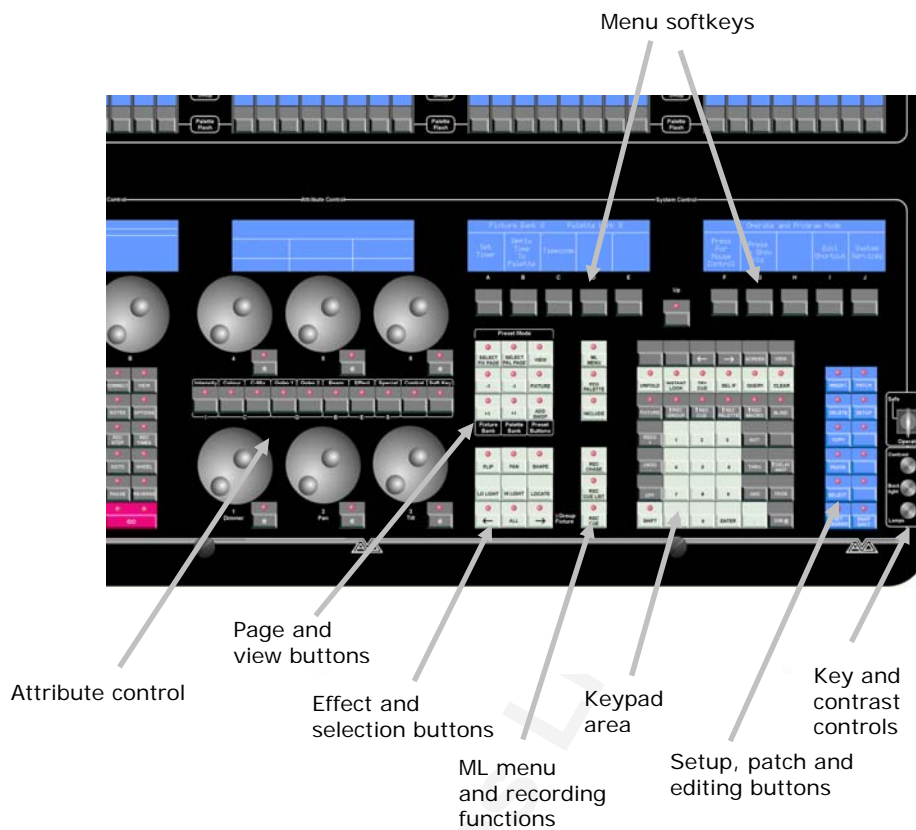

**Menu softkeys:** These two displays and 10 buttons are the nerve centre of the console, allowing you to select a wide range of menu options. The Up button takes you back to the previous menu level. Shift+Up takes you back to the top menu level.

**Attribute control:** This is where you set the position, colour, gobo, dimmer intensity and other attributes of fixtures when you are programming the console.

**Page and view buttons:** Page buttons allow you to swop the controls to another page of fixtures or cues. View allows you to show various screens on the displays.

**Effect and selection buttons:** These buttons provide useful functions when programming moving lights, and also allow you to step through selected fixtures one at a time.

**ML Menu and recording functions:** These buttons give access to the Moving Light menu and allow you to record chases, cues and cue lists

**Keypad area:** This area contains the numeric keypad for number entry, cursor buttons, the shift button (which accesses any functions with a small up-arrow next to them), and buttons to record groups, palettes, cues and macros.

**Setup, patch and editing buttons:** These buttons allow you to set up the console and also to edit programming.

**Key and contrast controls:** The key allows you to switch the console to Safe mode which is a playback-only mode preventing changes being made. Starting from the top, the knobs control LCD contrast, LCD back light brightness and desk lamp brightness.

## Cue Playback faders and buttons

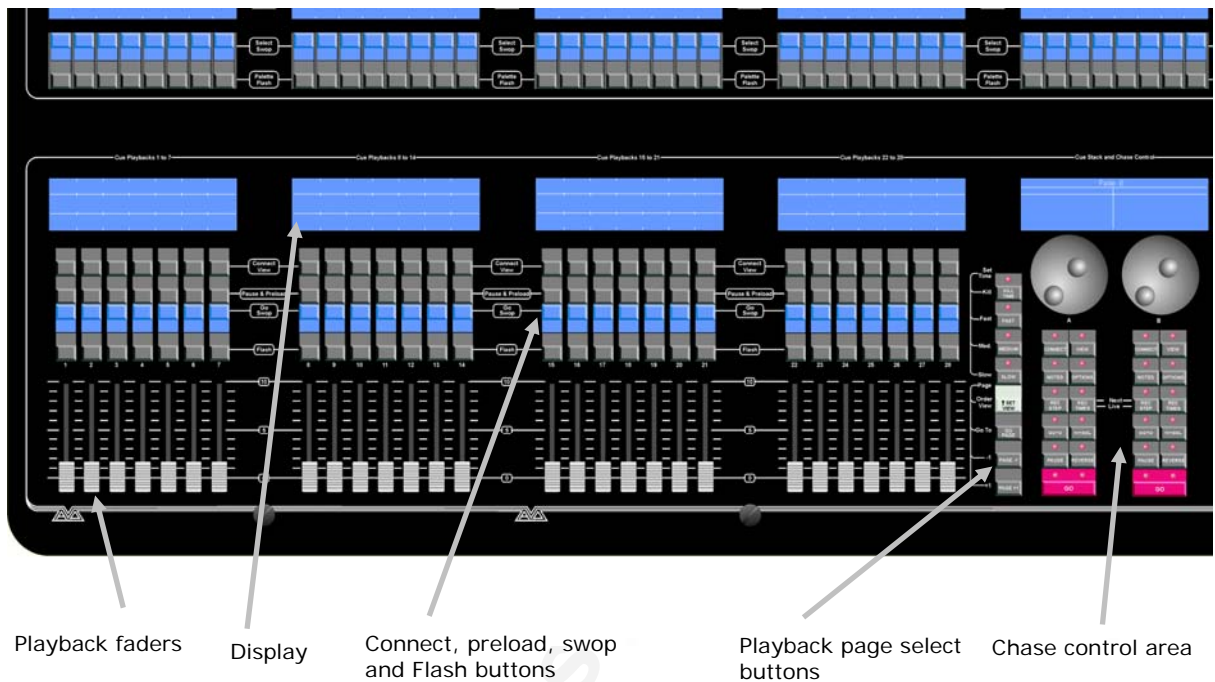

This area is where you store and playback cues, chases and cue lists (you can also store playbacks on the preset faders).

**Playback faders:** Allow you to fade the playback in and out.

**Displays:** Show legends for the playbacks, which you can set to help you remember what's in them.

**Connect, preload, swop and flash buttons:** The Connect button allows you to connect a cue list or chase to a chase controller so you can control playback and set timing and other options. The Preload button will position all moving light fixtures to the programmed positions in the cue so that when you fade up the fader, the lights will already be in their proper positions. The Swop button is used to select the playback when programming and can be used to "solo" the playback and the flash button is like moving the fader to full.

**Playback page select buttons:** The Vision console has 28 playbacks per page, the Elite console has 14. You can select a different page of playbacks using these page select buttons.

**Chase control area:** Allows you to start and stop chases and cue lists and control the speed, fade, direction and set other options

## Preset faders and buttons

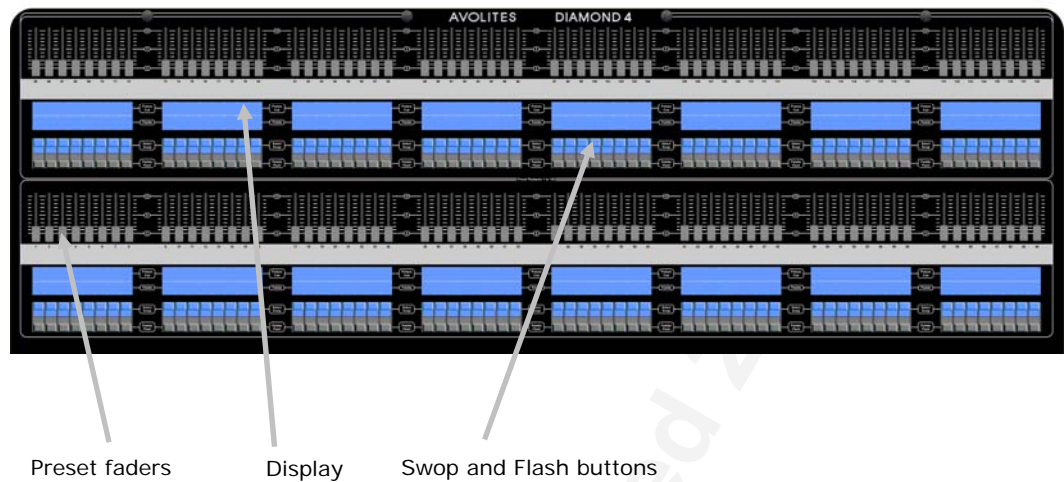

This area is where dimmers and fixtures are controlled, and also where palettes, groups, page shortcuts and playbacks may be stored.

**Preset faders:** Control the intensity of the dimmer or fixture. If a playback is stored on the preset the fader is used to fire the playback and set its level.

**Display:** The top section shows the name/type of the fixture patched to that fader. The bottom section shows which palette, group or shortcut is stored in each position.

**Select/Swop and Palette/Flash buttons:** The Select button selects the fixture for control. The Palette button recalls palettes, groups or page shortcuts.

## Other controls and connections

The rear of the console has all the connections. The front of the console has a CD or DVD drive, floppy drive and a keyboard/trackball in a drawer. The console's Serial Number is printed on the side of the keyboard.

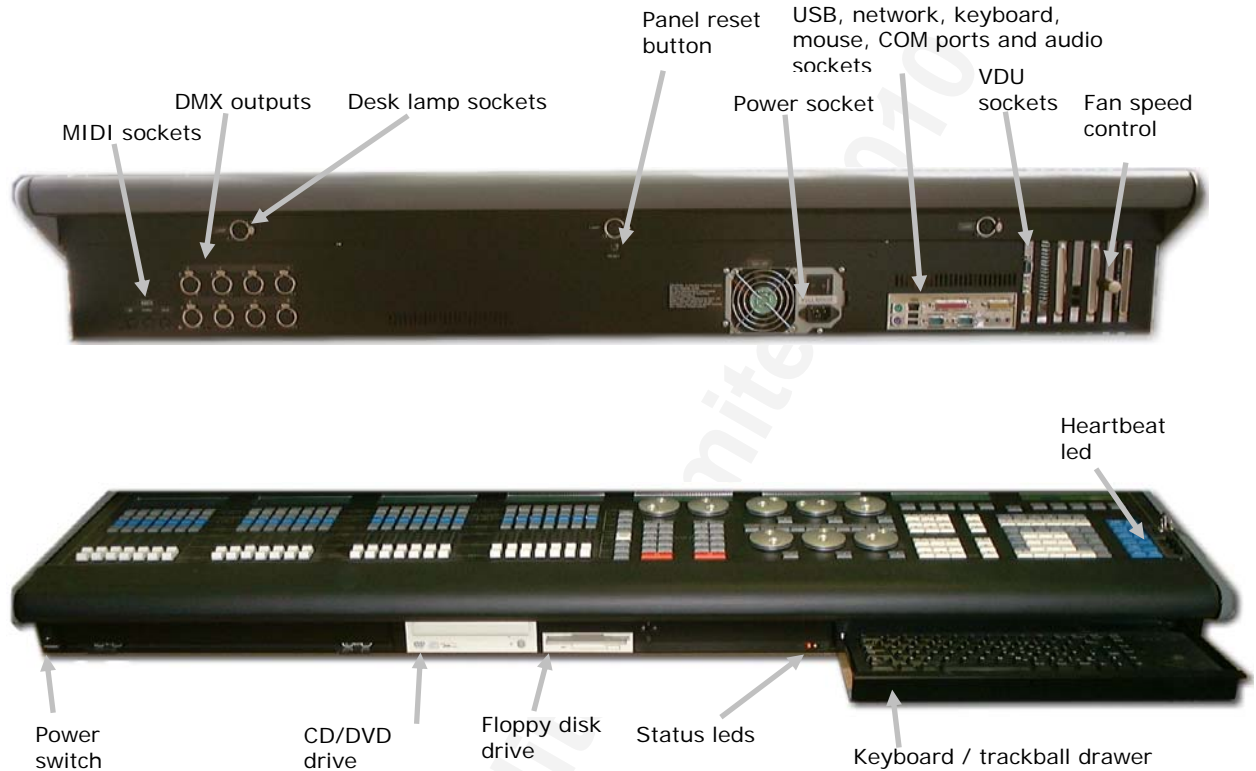

The "heartbeat" LED at the bottom right of the console should flash during normal operation. If the heartbeat stops, press the panel reset button. This will restart the control panels of the console. The main operating system is not affected by the reset button. The DMX output of the console will be interrupted while the control panels reset and will continue unchanged when the reset is complete.

## 1.2 Setting up the console

If the console has a 110V/240V selector switch, you must ensure it is set correctly before connecting the power. If the console does not have a voltage selector, it can be safely used on any mains voltage. If your mains supply is in any way suspect or prone to interruption, use a UPS (uninterruptible power supply) to give you chance to shut down the console properly if the power fails. If the console loses power unexpectedly it can cause delay when power returns due to the console checking itself.

You need to connect at least one VDU screen to the console (although in an emergency you can use it without one); it's often helpful to connect two screens. The Diamond has one VGA output and one DVI output; the DVI output can be used as a second VGA output by attaching an adaptor plug.

Lighting fixtures and dimmers are connected either to the eight DMX outputs on the rear of the console, or via a DMX Ethernet node. Each

output or node will control up to 512 channels. The outputs are wired to the DMX-512 standard: Pin 1 is earth, pin 2 is negative data and pin 3 is positive data.

### 1.3 Turning it on

Ensure the power switch on the power supply (rear of the console) is turned on (this switch can be left on permanently).

Press and release the power switch on the front left of the console to start it up (on a few consoles this switch is fitted at the back). The console displays should light up and the VDU screen should show a boot screen. The console takes about 20-50 seconds to start up fully.

If you have problems starting the console up, it may be carrying out a disk check due to not powering down correctly when it last ran. If this is happening you have to wait until it has finished the check before the console will run. The Troubleshooting section of the reference manual can help you out here (see section 1.8 on page 123).

### 1.4 Turning it off

Press and release the power switch. The console will perform a controlled shutdown which takes about 15-30 seconds. Do not disconnect the power from the console while it is shutting down. You should also avoid disconnecting the power to the console while it is running as any changes to your show (since the last Autosave) will be lost. This may also upset the operating system which will delay the next startup.

### 1.5 Operating the console

The console can be operated entirely from its buttons and faders, and the rest of this tutorial tells you how.

However, inside the console the Microsoft Windows XP Embedded operating system is used and there are a few "Windowsy" things you can do if you want to. Mostly you can forget that there's a computer inside and if you don't know how to use Windows, it doesn't matter.

The console VDU shows the Diamond 4 operating screen, on which you can show various information windows and views, and set options, using the menus.

You can arrange the way the view windows (stage view, DMX view etc) are shown on the screen using the trackball or a mouse in the usual way.

You can change the sort order of columns in the view windows by clicking on the top row of the column you want to sort on.

To access Windows functions such as Viewing a Folder (to move files around), Control Panel (to setup hardware), and to stop or restart the D4 application or run other programs, a Tools menu is provided at the top left hand side of the VDU screen. These functions are described in more detail in the reference manual.



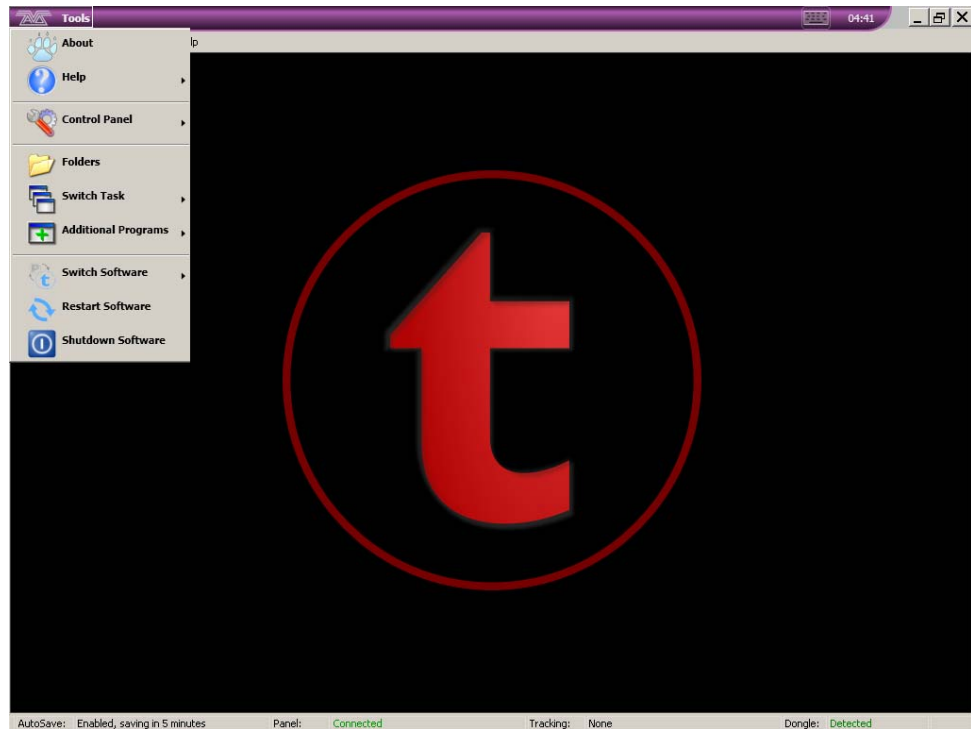

The console runs the Visualiser lighting simulator internally (this is where the second VDU screen can come in handy) which allows you to program a show without the rig connected or powered up. (You need to select "Simulator" mode in Visualiser to view the output from the Diamond)..

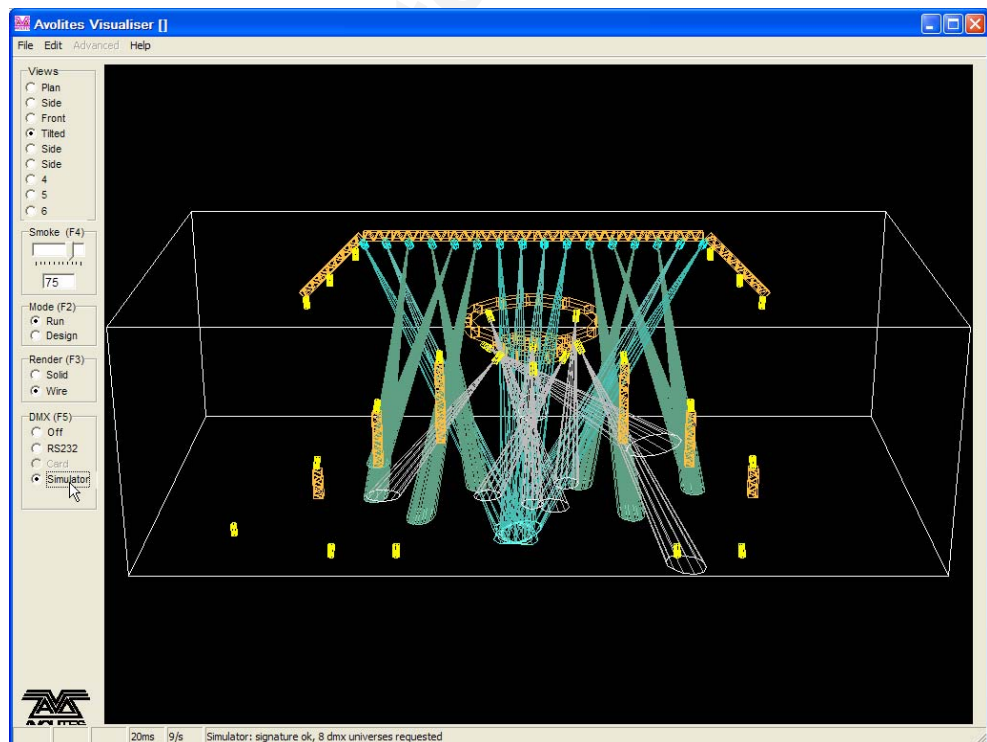

You can play audio CDs on the console, if you connect some speakers to the line out jack (green) on the rear of the unit (you can't use the headphone jack on the CD drive, if one is fitted).

## 1.6 The Diamond 4 Simulator and D4 Desktop

A console simulator is available as a free download from the Avolites website, allowing you to create or edit shows on a normal PC if you don't have access to the real console. (PC must be running Windows XP). The simulator runs identical software to the real console (including Visualiser), using a "virtual panel" on the screen to allow you to operate the controls.

You use the mouse to click buttons and move the faders and wheels. To save space on the screen, the blue select and grey palette buttons of the preset faders are not shown, instead you just click on the legend display below the fader. If you need to hold a button on the virtual panel and press another button, use the right mouse button to click the first button.

Shows saved on the simulator can be loaded directly into the real console.

The "virtual panel" displayed on the screen is split into individual sections which can be moved around independently. This avoids a lot of scrolling around to find the section you want.

By attaching the Avolites Ez-DMX adaptor, the simulator can become a fully functional console, the "D4 Desktop". You can also output DMX over the PC's Ethernet port by attaching the D4 USB dongle. The Diamond 4 Pilot is a USB-connected control device to provide hands-on sliders and controls for programming the D4 Desktop (see section 13 of the reference manual).





## 1.7 What you will need for the tutorial

The rest of the first part of this manual is a hands-on tutorial. If you have never used an Avolites console before, by working through the rest of the tutorial section you should be able to get the Diamond 4 up and running, and be well on the way to programming and running a show with it.

The tutorial is organised in the order you'll need to do things to get the console set up and working, so try to work through it in sequence. To make the most of it, you will need a few lights set up to play with; a couple of moving lights and a few dimmers would be best. If you can't lay your hands on any real lights, you can use the Visualiser to simulate some lights.

When you are preparing to start programming a new show, it's handy to have the following things.

- A lighting plan of your rig which you can scribble on
- A USB pen drive or some writable CD's to save your work
- Paper & pen to make notes (or a laptop, depending on how technological you are)
- Manuals or DMX tables for the fixtures you're using

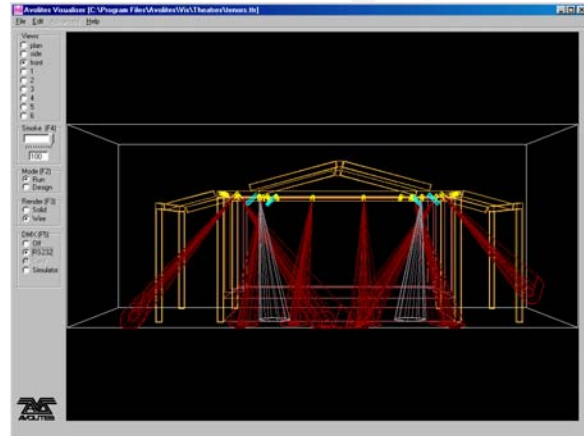

Copyright Avolites Limited 2010

## 2. Patching

In this chapter: how to set up the Diamond to control dimmers and fixtures.

- clearing the memory for a new show
- patching dimmers
- patching moving light fixtures
- setting addresses on the fixtures
- saving the show file

So, you have your fixtures and dimmers all connected up with DMX cables and the Diamond 4 connected to the end of it. (If you have a big rig, you might find it easier to learn the basics using a few dimmers and a few moving lights, and leave the rest of it till you're an expert).

First you need to allocate each fixture or dimmer to a preset fader on the Diamond, so that you can tell it which of the fixtures or dimmers you want to control at any time.

The fader and the blue button below it allow you to take control of a fixture and are called a Handle. The fader will control the intensity of the dimmer or fixture and the blue Select button is used when programming to select the dimmer or fixture.

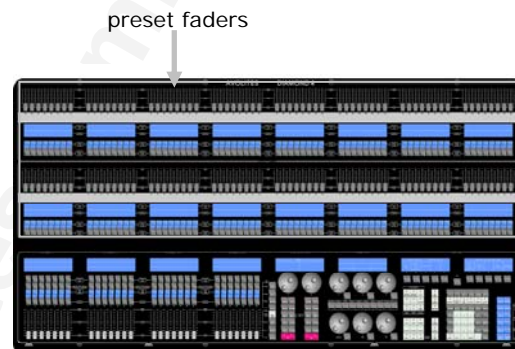

You also need to tell the Diamond what type of fixture is allocated to each fader. When you have entered this information, the Diamond can tell you what DMX addresses to set on your fixtures and dimmers and which DMX line to plug them into so they match the settings it is using. If you prefer, you can set your fixtures and dimmers beforehand and tell the Diamond what DMX addresses and lines it should be using.

This setup process is called **Patching**.

If you need to patch more than 128 dimmers and fixtures (96 on the Elite), you can select another page using the Fixture Bank buttons below softkey A.

The Diamond controls dimmers and fixtures slightly differently, so we will look at each in turn.

### 2.1 Clearing the Diamond - Wipeall

It's always a good idea to start a new show by wiping the memory before you start a new setup. This ensures that you are starting with a clean slate.

### Clearing the Diamond

- 1> Check the key is set to "Operate".
- 2> Press the blue Setup button (bottom right of console).
- 3> Select softkey A [Start new show Wipeall].
- 4> Press A [Press to Confirm Wipeall]. The console will be wiped.

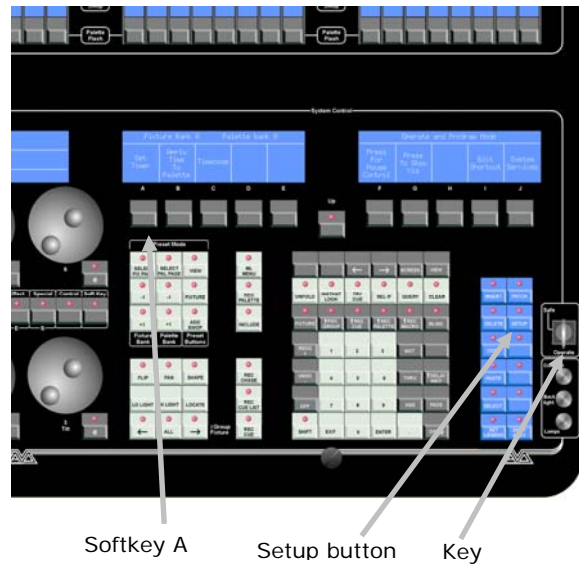

The Diamond is now pristine and new, with all playbacks empty, ready for you to start your show. (User settings will remain the same).

## 2.2 Patching dimmers

Each dimmer channel you want to use is allocated to one of the preset faders. Then, when you want to control the dimmer channel, you just raise the fader.

### Patching dimmer channels

- 1> Check the key is set to "Operate".
- 2> Press the blue Patch button (bottom right of console).
- 3> Press A [Dimmers].
- 4> The Diamond will start at DMX address 001 on output line A (shown above Softkeys A and B on the display). If your dimmer rack is at a different address, you can change this by pressing B [Dmx=xx], typing in the new address on the numeric keypad and pressing Enter. If it is on a different DMX line, press A [Line=A Press to Change].
- 5> Press the blue "Select" button below preset fader number 1. The fader and Select button will now be used to control that dimmer channel.

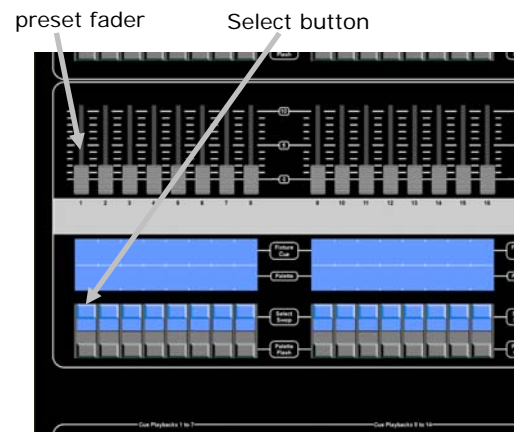
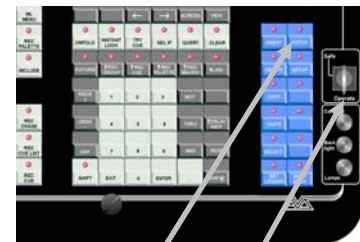

- 6> The display below the fader will show the dimmer fixture number and its output level.
- 7> The Diamond will update the DMX address to the next free channel, so you can just press another button to patch the next dimmer.
- 8> Press Shift and Up to exit patch mode.

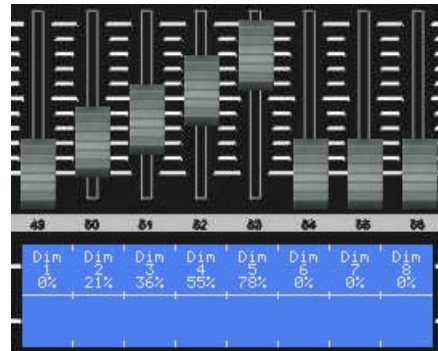

You can now control the dimmer channel on preset 1 using the fader.

If you have lots of dimmers to patch, there are some quicker ways. If you just want to patch 10 dimmers in sequence on to presets 21-30, you can do it this way:

---

#### **Patching a range of dimmers to preset faders**

- 1> Enter Dimmer Patch mode.
  - 2> Enter the DMX channel you want the range to start at, if it's different to the one the Diamond is displaying.
  - 3> Hold down the Select button of the first fader to be patched (preset 21).
  - 4> Press the last Select button (preset 30).
  - 5> Release the first Select button, then the last Select button.
  - 6> Each preset fader will be patched in order to a dimmer channel.
  - 7> Press Patch then Exit (or "Up") to exit patch mode.
- 

You can also patch more than one dimmer channel on the same fader. This can be useful when you have several lights on different dimmer channels, but you always want to control them together. For example, if you have lit an area with several spots and you just want them all to come up on one fader, this is a good way to do that.

---

#### **Patching several dimmers to the same fader**

- 1> Enter Dimmer Patch mode.
  - 2> Enter the DMX address of the first dimmer channel to be patched.
  - 3> Press the Select button for the preset you want to use (this patches the first dimmer).
  - 4> Enter the DMX address of the next dimmer channel to be patched (the Diamond will have automatically increased the address by 1).
  - 5> Press the Select button again.
  - 6> Press Patch then Exit (or "Up") to exit patch mode.
- 

You can repeat this procedure to patch as many dimmers as you like on to one preset fader.

You can see how DMX channels are patched by opening the DMX window on the VDU screen. Press the grey View button (below softkey

H), then press softkey G [DMX].

You can also display the DMX channel each fader is patched to by pressing the white View button (below softkey B) then C [DMX]. The display below each fader will show the DMX channel

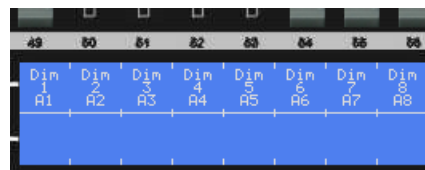

it is controlling and the DMX line A-H (A1=channel 1 on DMX line A). If multiple dimmers are patched, only the first one is shown. Press the white View button (below softkey B) then A [Intensity] to go back to showing the intensity below the fader.

## 2.3 Patching moving light fixtures

Moving light fixtures are controlled slightly differently to dimmers; a dimmer only has one controllable attribute, intensity, but a moving light fixture can have many attributes, such as pan, tilt, colour, gobo etc. However, the principle is still the same.

The Diamond has personality files for most lighting fixtures in the known universe, and these are stored internally in the console. If you want to use a personality not available in the console, you can download it from the Avolites website and copy it to the console. See section 12 in the reference manual for details of how to download personalities.

### **Patching a fixture**

- 1> Press Patch (bottom right of console).
- 2> Press B [Fixtures].
- 3> A list of fixture manufacturers will appear above the softkeys.

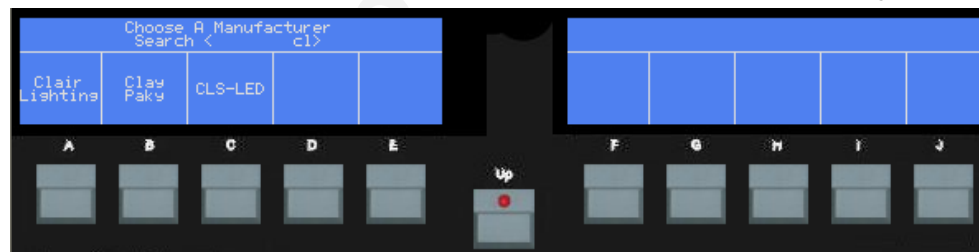

- 4> Press the button for [Clay Paky], or type the first few letters you're looking for on the Qwerty keyboard to just show matching names. (The button may change depending on the fixture library you're using. Use Softkeys I and J to page through the list of manufacturers until you find it.)
- 5> A list of fixtures made by Clay Paky will appear above the softkeys.
- 6> Type "GOL" on the keyboard, or keep pressing J [More] to show the next page, until you see a button for [Golden Scan 3]. Press that button to select the fixture type.
- 7> The display will show "Select a mode for the Clay Paky Golden Scan 3".
- 8> Press B [6 DMX Rain On] to select the 6-channel mode. Make sure you choose the mode which matches the setting of the fixture.
- 9> The Diamond will offer you the first free DMX address above Softkey B. You can change this by pressing B [DMX=x] and typing the new address on the numeric keypad.

- 10> Press the Select button on preset 41 to patch a Golden Scan 3 to preset 41.
- 11> The display below the fader will show what you have patched. You can show the DMX channel it is patched at by pressing Preset Mode View (just below Softkey B) then C [DMX].
- 12> Patch more fixtures, or press Shift and Up when you have finished to exit patch mode.

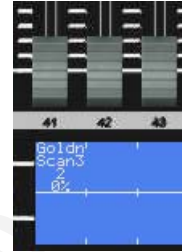

Note: If the keyboard search function appears not to work when you try to type in a manufacturer or fixture name, this is probably because another application has the Windows "focus" rather than the D4 application. Hold down the Alt button on the keyboard, then keep pressing Tab (above Caps Lock) until you see the Diamond 4 Titan application highlighted (as shown in the picture). Then release the Alt button.



You can continue to patch this type of fixture at the next free DMX address by pressing the next Select button you want to use. You can also patch a range of fixtures by holding down the first button in the range and pressing the last button, as with dimmers.

If you want to patch different fixtures, you can change the type of fixture to be patched very easily.

### **To change the fixture type**

- 1> Press F [Select a manufacturer] to choose a fixture from a different manufacturer, or
- 2> Press G [Select a Fixture] to patch a different fixture from the current manufacturer, or
- 3> Press H [Select a new mode] to patch the current fixture in a different mode.
- 4> Choose the fixture type from the list on the softkeys.
- 5> Patch as before.

The Diamond has eight physical DMX output lines, identified as A, B, C, and so on up to H. You can patch onto any of the 8 lines by using C [Change DMX line mapping]. However, to keep it simple, stick to line A while you are learning.

## **2.4 Setting legends for fixtures**

You can set a legend for each fixture (or dimmer) to help you remember where it is on the stage. The legend is shown on the display



below the fixture's fader and Select button in place of the fixture type.

---

### **Setting fixture legend**

- 1> Press the blue Set Legend button (bottom right of console).
  - 2> Press the Select button of the fixture you want to set.
  - 3> Type the legend on the Diamond's keyboard. You can only display 2 rows of 5 characters so make it brief!
  - 4> The legend appears by the fixture's handle as you type it. It is also displayed above softkey C so you can see how it is going to be formatted.
  - 5> Press Enter to store the legend.
- 

Note: If the keyboard appears not to work, this is probably because another application has the Windows "focus" rather than the D4 application. Use Alt-Tab to select the D4 application (see section 2.3 above for details.)

## **2.5 Addressing lights to match the Diamond**

For the purposes of this tutorial, it's easiest to let the Diamond allocate all the DMX addresses, then go round to the actual dimmers and fixtures and set the addresses to match the Diamond's settings. This makes sure that there are no overlaps or gaps in the DMX addresses.

In a real lights rig it's a good idea to plan out the DMX map beforehand (either yourself, or patch the Diamond before rigging using the simulator). You can then set up your fixtures before they are rigged.

The Diamond can tell you the DMX address it is using for each fixture. Write down the addresses for all the fixtures, then go and set them.

---

### **Displaying the DMX address for fixtures**

- 1> Press the Preset Mode View button (below Softkey B).
  - 2> Press C [DMX].
  - 3> The displays below the fixture faders show the DMX addresses of each fixture, with the DMX line and address (e.g. A24 is address 24 on DMX line A).
  - 4> If you press View again, then a fixture select button, a window will open on the VDU screen showing all the DMX details for that fixture (shown on next page).
  - 5> The DMX window on the VDU screen shows you all the DMX channels and how they are patched. If you can't see this window, turn it on from the View menu on the VDU screen.
- 

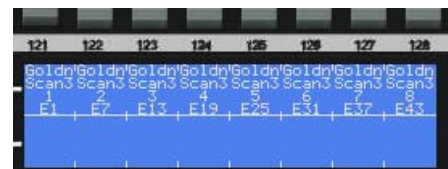



Dmx			Wheels			
Offset	Address	Control	Bank	4	5	6
1	A1	Iris	Intensity			
2	A2	Colour	Colour	Colour		
3	A3	Frost	C-Mix	Cyan	Magenta	Yellow
4	A4	Dimmer	Gobo 1	Gobo 1	Gobo 2	Gobo 2 Rot
5	A5	Pan	Gobo 2			
6	A6	Tilt	Beam	Iris	Zoom	
7	A7	Zoom	Effect	Frost	Focus	
8	A8	Focus	Special	Prism	Prism Rotation	
9	A9	Prism	Control			
10	A10	Prism Rotation	Softkey			
11	A11	Gobo 1				
12	A12	Gobo 2				
13	A13	Gobo 2 Rot				
14	A14	Cyan				
15	A15	Magenta				
16	A16	Yellow				

## 2.6 Changing what you have done

If you need to change the patching you have done, it's possible to re-patch a fixture to a different DMX address using the Edit Fixtures menu (Press the blue Patch button, then F [Edit Fixtures] then B [Repatch a fixture]). You can move a fixture to a different handle, make a copy of a fixture, and delete a fixture. How to change the patching is described in detail in the reference manual in section 2.2.1 on page 130.

## 2.7 Patch Utilities

You can invert the operation of channels and set various other fixture-specific options from the Patch menu. Inverting pan and tilt channels can be useful to mirror fixtures on opposite sides of the stage, or to correct for a fixture being rigged the wrong way round. Section 4 of the reference manual on page 133 describes how to set these options.

## 2.8 Completing the patch

When you have patched all your dimmers and fixtures, press Patch then the Exit button on the numeric keypad to go back to normal mode (or press Shift and "Up"). You have now finished setting up the lighting system, and it's time to get to work on programming a show. But there's one important thing to do first...

## 2.9 Saving the show

You can save any number of different shows on the Diamond's internal hard disk.

### ***Saving the current show***

- 1> Press the blue Setup button.
- 2> Press D [Save Show].
- 3> Press E [Use Current Show] to just save the latest version of the

current show, or if you want to save it under a new show name, enter a show name on the keyboard. (You can press D to insert the time and date into the filename).

- 4> Press Enter. The show will be saved.
- 5> Press Up to leave Setup mode.

The Diamond will automatically load the last show when it is turned on. If you want to load a different show:

#### **Loading a different show**

- 1> Press the blue Setup button.
- 2> Press B [Load Show].
- 3> Available shows are listed on the softkeys; press the key to load the show (if there are more than 8 the I and J keys show more pages).
- 4> Press Up to leave setup mode.

The Diamond will automatically save your show to its internal hard disk when you shut it down. It will also autosave the show every 30 minutes (you can alter the time, tell the console to keep multiple backups of the show, or turn this off) in case the console loses power. However, it's a good idea to regularly copy a backup of the show to USB pen drive just in case something bad happens to the console.

#### **Creating a backup of the current show**

- 1> Insert a USB pen drive.

- 2> On the VDU, click on the File menu and select "Save Show".

- 3> Pull down the "Save in" list and select the drive where you want to make a backup of the show (only Removable

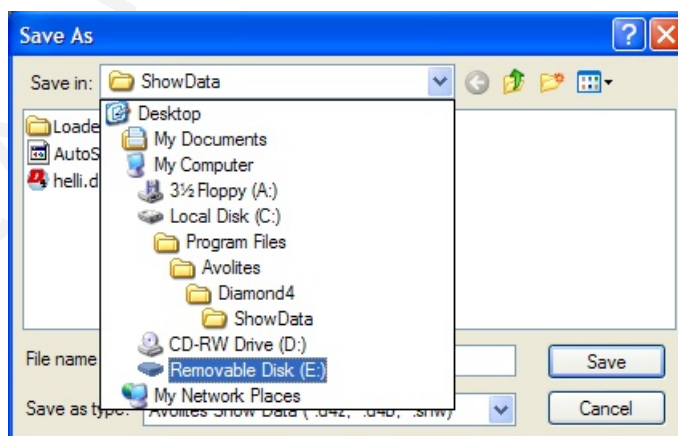

USB drive; you cannot use Save Show to save to a CD drive).

- 4> Type a filename for the show in the "File name".
- 5> Click on Save.

To reload a saved show from a removable device, use the Load Show option on the VDU File menu.

To backup existing shows from the Diamond's hard drive, you have to copy them across using Windows functions like this.

#### **Creating a backup of an existing show**

- 1> On the VDU screen, click on the File Explorer icon in the top right corner. If your VDU has a Windows XP start button, click Start

then My Computer.

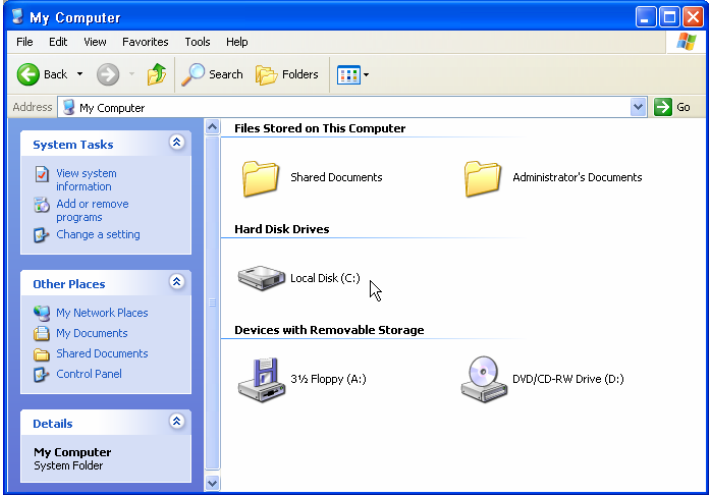
- 2> Double click on "Local Disk (C:)" .
  - 3> Double click on the "Program Files" folder, then the "Avolites" folder, then the "Titan" folder.
  - 4> Double click on the "ShowData" folder .
- 
- 5> The VDU screen will show a list of the saved shows.
  - 6> Click on the show you want to backup. If you want to backup more than one, hold down the Ctrl button on the keyboard while clicking them.
  - 7> Right click on a selected file, and select "Send to" from the pop up menu which appears.
  - 8> Select the USB drive where you want to make a backup of the show file. The file will be copied
  - 9> You cannot write files to CD-R, you must use a USB drive.

For a complete live backup system see page 217.

Shows saved on a console using Titan software cannot be loaded into a non-Titan console. If you need to do this, you can save the show as an older version, by pressing F [Save Show For Version 2] in the Save Show menu.

## 2.10 Examples

### **How do I patch a 6 channel DMX dimmer pack at DMX address 13 to faders 1-6?**

Press Patch, then A [Dimmers]. Press B [DMX=x] and type "13" on the numeric keys, then press Enter. Hold the blue Select button for preset 1, then press the Select button for preset 6. Release both buttons. Press Shift & Up to leave Patch mode. Finally ensure your dimmer pack's DMX address is set to 13 and it is connected to Line A. (If you are not sure what address the dimmers are patched at, press Preset Mode View (below softkey B) then C [DMX]. The display below each fader will show the DMX channel it is controlling).

### **How do I patch a Mac600 on DMX address 65 to handle 10?**

Press Patch, then B [Fixtures]. Type "MAR" on the Qwerty keyboard, then select the "Martin" softkey. Then type "600" to list the mac600 fixtures on the softkeys; select the Mac600 fixture by pressing its softkey (press J [More] if it is not on the first page). Select the DMX mode required from the options on the softkeys (the mode should match the setting on the fixture). Press B [DMX=x] and type "65" on

the numeric keys, then press Enter. Press the blue Select button of preset 10 to patch the fixture. Press Shift & Up to leave Patch mode. Finally ensure the Mac600 is set to the correct DMX address and mode.

Copyright Avolites Limited 2010

## 3. Controlling dimmers and fixtures

In this chapter: how to control dimmers and fixtures manually.

- controlling dimmers and fixtures
- changing attributes
- using and creating groups
- align and fan functions

Having patched all the dimmers and fixtures you want to use, you are ready to start operating them. This chapter explains how you do this.

The **Elite** version of the console does not have faders for the upper 48 preset handles, just Fixture Select and Palette buttons. You can select whether the lower 48 faders control the upper or lower handles using softkey D at the main menu. The settings are [Preset Faders control fixtures 1-48] (lower) or [Preset Faders control fixtures 49-96] (upper).

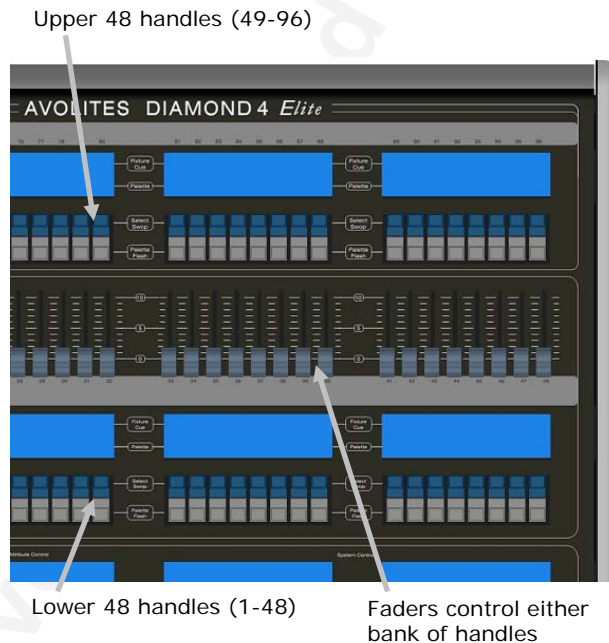

### 3.1 Controlling dimmer channels

Controlling dimmer channels is simple – you just push up the fader of the preset where the dimmer is patched. The display below the fader shows the output level of the dimmer. On the Diamond, dimmers work just like a normal “preset” lighting desk. If you want to turn on lots of dimmer channels at the same time, you can also select the dimmers and use the Dimmer control wheel as described below, or you can enter the dimmer levels on the numeric keypad using the Dim@ button.

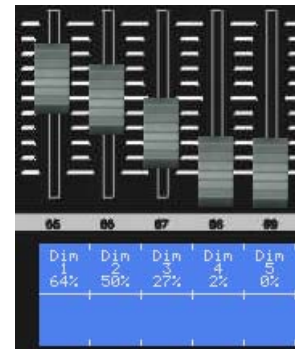

### 3.2 Controlling fixtures

Controlling fixtures is nearly as simple, except there are a few more attributes to control than just intensity.

The first thing you have to do is to select the fixtures that you want to control. The Diamond then knows that any changes you make are only to be sent to these fixtures. You can select fixtures individually, or

several at once. You can then control the selected fixtures using the attribute wheels as described in the next section.

### Selecting fixtures or dimmers

- 1> Press the blue Select buttons for the fixtures you want to control.
- 2> The display above the Select button will go inverted to show you which fixtures are selected. If you've got the Stage View or Intensity View windows open on the VDU, the selected fixtures are highlighted in dark blue.
- 3> If you select a fixture you don't want, press its Select button again to deselect it.
- 4> You can select a range of fixtures by holding down the Select button for the first fixture in the range, then pressing the Select button for the last fixture.
- 5> Press Shift and the Locate button to position the selected fixtures at a central position with the light on, so you can see where they are. Dimmer channels are set to 100%.  
(Pressing the Locate button without Shift will turn the fixture on to open white without changing its position).

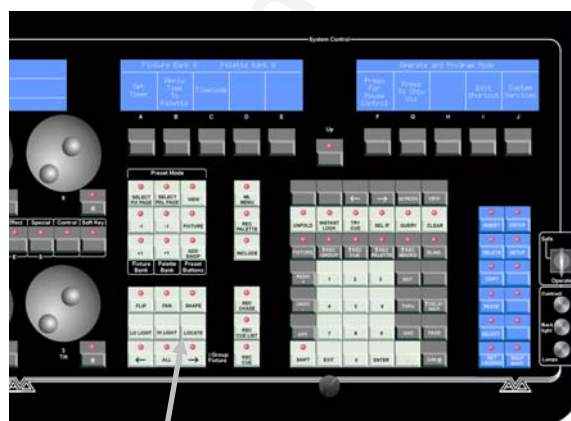
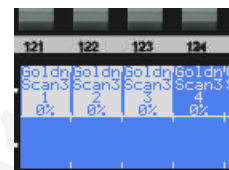

Locate

You can change the fixture page, if you need to, by pressing the Fixture Bank -1 or +1 buttons, or by pressing "Select Fix. Page" button and selecting the required page from the softkeys (or typing the new page number on the numeric keys, followed by Enter).

Some fixtures may power up with their lamps turned off, in which case you will need to send a command to turn lamps on, like this.

### Turning fixture lamps on using macros

- 1> Select some fixtures using the Select buttons.
- 2> Press the ML Menu button (below softkey D).
- 3> Press E [Fixture Macro].
- 4> Select the [Lamp On] button.
- 5> The selected fixtures should strike up. It might take a couple of minutes for their lamps to reach full brightness..

### 3.3 Changing attributes of fixtures

Having selected the fixtures you want to control, you then need to select which attributes (pan, tilt, colour etc.) of those fixtures that you want to change.

The attributes are selected using the attribute wheels and buttons in the front centre of the Diamond. The three wheels nearest to you are always allocated to Dimmer, Pan and Tilt attributes. The top three wheels can be selected to control different attributes using the buttons below them.

The attributes you can control will vary depending on the type of fixture you are using. For dimmer channels, you can only change the "Dimmer" attribute (intensity). For intelligent fixtures, you can control pan, tilt, colour, gobo and many other functions.

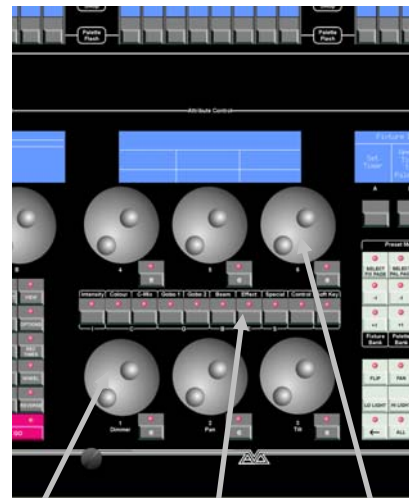

Dimmer, Pan, Tilt  
wheels

Attribute buttons

Selectable  
wheels

---

#### ***Controlling pan and tilt of a fixture***

- 1> *Select some fixtures using the Select buttons.*
  - 2> *Press Shift and Locate to position the fixtures at a central position with the lamp on (you don't have to do this, but it helps you see what's happening).*
  - 3> *Control the tilt using the Tilt wheel and the pan using the Pan wheel. You should see the selected fixtures move.*
  - 4> *Hold down Shift while turning the wheels to make large changes.*
  - 5> *The display above the wheels shows you which attribute is being controlled by each wheel and the value being output.*
- 

Any other attribute of the fixtures you selected can be controlled by pressing one of the attribute buttons and using the top three wheels. The display will show which attributes the wheels are going to control. Very few fixture types have the full range of attributes; if the display remains blank when you select an attribute button, that attribute is not available on the fixtures you selected. Some attributes might have more than one "page", this is shown by the button flashing.

This example uses the Clay Paky GoldenScan 3 which we patched earlier.

---

#### ***Controlling other attributes using the wheels***

- 1> *Select some fixtures using the Select buttons and Locate them.*



- 2> Press the Colour attribute button below the top row of wheels.
- 3> Set the colour mode using wheel 4. Control the colour using wheel 5 (this may be different for other fixture types). You should see the selected fixtures change colour.
- 4> The display area above the wheels shows you which attribute is being controlled by each wheel and the output value of the attribute.

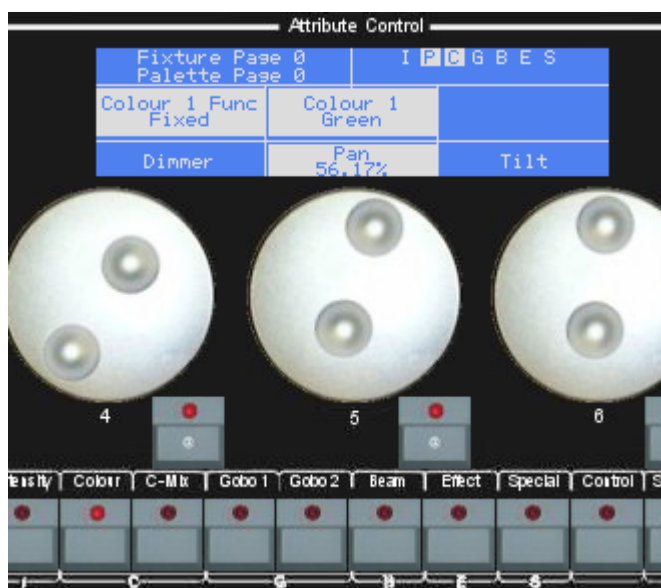

You can use the Dimmer wheel to control the intensity channel of the fixture, or you can use the preset fader which it is patched on. The effect is the same.

Note: Once you have changed any attributes, all the selected fixtures will be automatically deselected the next time you press a fixture select button.

Sometimes control of a complicated attribute is shared by several wheels, called Function Wheels. For example a rotating gobo may have one function wheel to select continuous or indexed mode, and another function wheel to control rotation speed or position. This makes it much easier to find the function you want when the actual fixture may have both these functions (and more) combined into a single DMX channel.

You can also select attributes (such as "Green" or "Open Gobo") from a list on the softkeys. This can be easier than scrolling through all the values on the wheels.

### **Setting attributes from the softkeys**

- 1> Select some fixtures using the Select buttons and Locate them.
- 2> Press the Colour attribute button below the top row of wheels.
- 3> Press Shift and the "@" button below the wheel labelled "Colour" on the display (usually 4 or 5).
- 4> The softkeys now give a list of possible colours on the fixture's colour wheel. Press a key to instantly set the selected fixtures to that colour.
- 5> You can also select gobos, gobo rotation and so on like this.

## **3.4 Attribute groups - IPCGBES**

To make life a bit simpler, the Diamond groups together attributes which have similar effects, using the letters IPCGBES. You can see these letters below the Attribute select buttons.



I-Intensity (dimmer, strobe, shutter)  
 P-Position (pan, tilt)  
 C-Colour (colour wheel, CMY mixing)  
 G-Gobo (gobo wheels, gobo rotate, gobo position)  
 B-Beam (iris, focus, zoom, beam shaper)  
 E-Effects (prism, frost)  
 S-Special (motor speeds, control)

This becomes important later when you are recording palettes, shapes, cues and cue lists.

When you change an attribute using the wheels, the IPCGBES letters on the display above the wheels will light up to show you the attributes which have been changed.

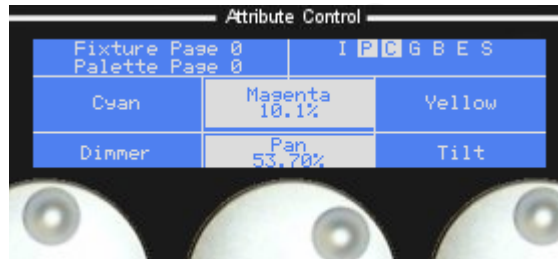

### 3.5 Using groups

If you've got several units of one fixture type, you often want to select them all at the same time. To avoid lots of select-button-pressing, the Diamond allows you to create a group of fixtures or dimmer channels. This is stored on a grey Palette button; you can then select all the fixtures in the group just by pressing one button.

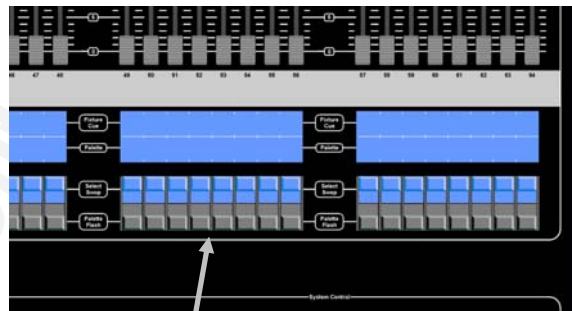

#### **Creating a group**

- 1> *Select the fixtures or dimmer channels you want to put into the group.*
- 2> *Press Shift and "Rec Group" (above the numeric keys).*
- 3> *Press the grey Palette button where you want to save the Group.*

Once you have created a group, you can then quickly select all the fixtures in the group:

#### **Selecting a group of fixtures**

- 1> *Press the grey Palette button where you saved the group.*
- 2> *The fixtures in the group are selected.*

You can set a legend for the group by pressing the blue Set Legend button, then the palette button where the group is stored, then typing the legend on the keyboard.

### 3.6 Copying settings from other fixtures – Align

If you've set a nice colour on one of your fixtures, and you want to copy it to all the other fixtures of the same type, the Diamond's Align function can do that. You can also use it to make all pan and tilt positions the same for a range of units or to make dimmer levels the same.

---

#### **Copying settings from other fixtures**

- 1> Select the fixture or dimmer you want to copy from.
- 2> Select the fixtures or dimmers you want to copy to.
- 3> Press the ML Menu button (below softkey D), then D [Align fixtures by attribute].
- 4> Select the attributes you want to copy using the softkeys (all are OFF to start with) and press Enter.

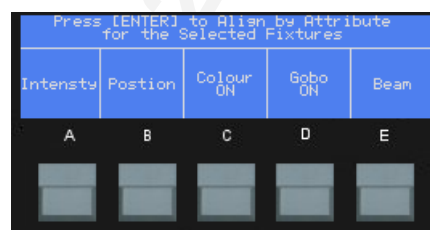

If you want to align all attributes, you can press ML Menu then C [Align fixtures].

### 3.7 Fan mode

Fan mode automatically spreads out a selected range of fixtures to produce a fan of light beams, like rays of sunlight. The first and last fixtures of the range are affected most, and the central fixtures are affected least. The amount of fan can be set using the wheels.

**Note:** The order in which you select the fixtures sets how the fan effect works. The fixtures you select first and last will be the ones which change most.

The fan effect, while normally used on pan or tilt attributes, can be applied to any attribute.

---

#### **Fanning out a range of fixtures**

- 1> Select the range of fixtures you want to fan and Locate them.
  - 2> Tilt the fixtures away from their 50/50 central position.
  - 3> Press the Fan button (to the right of wheel 3).
  - 4> Move the Pan (or Tilt) wheel to fan out the fixtures.
  - 5> Press one of the other attribute buttons and use the top wheels to fan other attributes.
  - 6> Press the Fan button again to exit Fan mode when you've finished.
- 

You will be able to see the effect of fan mode best if you have a row of at least 4 fixtures. If you have an odd number of fixtures, the central fixture will not move in fan mode.

Remember to turn off Fan mode when you have finished (by pressing the Fan button again), or you will get very confused when the controls don't do what you expect.

## 3.8 Examples

### ***How do I fade up the dimmers on presets 1-6?***

Just push up the faders 1-6.

### ***How do I make the Mac 600 on handle 10 go blue and point at the cyclorama?***

Select the fixture by pressing the blue Select button for fader 10. Press Locate (to the right of wheel 3) to set the Mac 600 to open white. Turn wheels 2 (pan) and 3 (tilt) until the fixture is pointing in the right place. Press the "C-Mix" attribute button. Turn wheel 4 clockwise to increase the amount of Cyan (you can turn wheel 5 clockwise to increase the Magenta which will give a darker blue). You can also type in a value for the Cyan by pressing @ (below wheel 4): type in a cyan percentage from 0 to 100, then press enter.

Copyright Avolites Limited

Copyright Avolites Limited 2010

## 4. Palettes

In this chapter: how to use palettes to set colours, gobos and positions.

- Using palettes to set values
- Creating your own palettes
- Setting which attributes are recorded in a palette
- Shared and individual palettes

When you are programming or controlling your lighting, it is nice to instantly call back a position for a set of lights such as centre stage, or set all lights to a particular colour like red, blue etc, rather than having to set the values on the wheels every time.

The Diamond allows you to store these settings on the grey Preset buttons, and they are called "palettes".

Palettes have another big advantage. If for example you program a centre stage spot position as a palette, when you use this position in a cue the Diamond remembers the palette you used, rather than the actual value. This means that if you move to another venue, you can just reprogram the "centre stage spot" palette and every cue using that position will automatically be updated. If you'd programmed all your cues directly using the wheels, you would need to go through and reposition every single cue.

Palettes are also useful when you are programming using Visualiser and you don't know exactly where the lights will point; you can program your cues using palette positions, then you just update a few palettes when you get the real lights in the real venue and the show programming is done.

### 4.1 Creating a palette

You can easily save your own palettes, or modify existing ones. We'll create a position palette; when you use this palette it will only affect the positioning of the fixtures and will leave all the other attributes unchanged.

#### **Creating a palette**

- 1> Press Clear (next to the numeric keys) to clear all the changes you have made so far.
- 2> Select a couple of fixtures and press Shift and Locate.
- 3> Position the fixtures using the tilt and pan wheels.
- 4> Press Rec Palette (below softkey D).
- 5> Press D [Set mask=Exclude All].
- 6> Press A [Press to set mask].

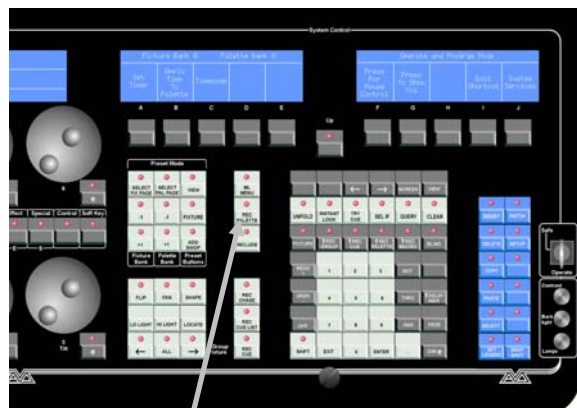

Rec Palette button

- 7> Press B until the display shows [Save All Pan Tilt Channels]. This ensures that only the Pan & Tilt information will be stored in the palette.
- 8> Press Up.
- 9> Press one of the grey palette buttons to store the positions. The position of the fixtures is stored as a palette.
- 10> The display above the palette button will show an automatic name for the palette.

You can set a legend for each palette to help you remember what it is. This is shown on the display above the palette select button.

#### **Setting a legend for a palette**

- 1> Press the blue Set Legend button (bottom right of console).
- 2> Press the grey Palette button whose legend you want to set.
- 3> Type the legend on the keyboard and press Enter.
- 4> There is only room for 2 rows of 5 letters; the display by the palette button and the display above Softkey C updates as you type to show you what it is going to look like.

The bottom line of the palette name shows you which type of attributes are saved in the palette using the IPCGBES letters (I=intensity, P=position, C=colour etc, see section 1.3.4 on page 32 for the full list). If there are more than 4 attributes the display shows the first 4 with a ... sign, as shown in the middle palette in the picture.

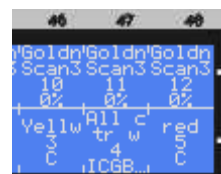

## 4.2 Using a palette

The Diamond shows you the available palettes on the bottom line of the display above the palette buttons.

#### **Using palettes**

- 1> Select the fixtures you want to control by pressing their Select buttons.
- 2> Press the grey Palette button for the palette you want to recall.

You can have many different pages of palettes. Select different pages using the Palette Bank buttons below softkey B. The available pages are shown on the softkeys.

## 4.3 What's stored in a palette

Although you can store all attributes of a fixture in a single palette, it's easiest to store some palettes which only affect colour, others which only affect position, and so on. This means when you recall a palette entry, you know which attributes of the fixture are going to change. It's also helpful when you're running a show to have position palettes saved in one area of the console, colour palettes in another area, and so on, then you can find everything quickly.

You do this using the Mask function when saving the palette. In the

example above, we had the "Pan-Tilt" attribute selected when storing the palette, so only the pan & tilt values were recorded.

### **Setting which attributes will be recorded in the palette**

- 1> Press Clear to clear all the changes you have made so far.
- 2> Select a couple of fixtures and Locate them.
- 3> Set a colour using the "colour" attribute button and wheels.
- 4> Position the fixtures using the "pan-tilt" attribute button and wheels.
- 5> Press Rec Palette (below Softkey D).
- 6> Press D [Set Mask=Exclude All].
- 7> Press A  
[Press to set mask].
- 8> Softkeys A-G allow you to set which attributes will be stored and which will be excluded.
- 9> Press Up when you have set the attributes you want.



If you press C [Set Mask=Save All] before storing, this will store all the attributes of the fixture in the palette.

## 4.4 Shared and normal palettes

For some attributes, such as colour, you want to set the same control values on all the fixtures of the same type. So if you pick red, you want the control value for "Red" to go to all fixtures.

For other attributes, like position, each fixture needs a different setting to get the light beams to point where you want.

When saving a palette you can set whether it will be Shared or Normal.

If you select J [Save As Shared Palette] when creating a palette, the value will be available to all fixtures of that type.

This is very useful if you patch more fixtures of that type at a later date, as they will be able to use all the shared palettes. Shared palettes are shown with a "S" symbol on the display as shown for Pal 4 in the picture.

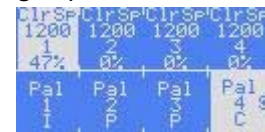

If you select I [Save as Normal Palette], the Diamond creates an "individual" palette which stores a different value for each fixture. This is normally used for positioning palettes, and sometimes for image focusing. You can add positions for more fixtures to a Normal palette just by saving the palette again with the new fixtures set.

## 4.5 Examples

### **How do I store a palette which makes my Mac 600's point at the cyclorama?**

Press Clear to clear any changes. Press the select buttons for the Mac fixtures. Press Locate to turn them on. Press the "→" button to the right

of wheel 3. The first fixture will be selected. Use wheels 2 and 3 to point the fixture where you want. Press the "→" button again and point the next fixture. When all fixtures are positioned, press Shift and Rec Palette. Press I [Save as normal palette]. Press D [Set Mask=Exclude All]. Press A [Press to set mask]. Press B until the option shows [Save all pan tilt channels]. Finally press the grey Palette button where you want to store the palette. The pan and tilt settings only will be stored.

***How do I make the Mac 600's point at the cyclorama using the palette I just saved?***

Press the select buttons for the Mac600 fixtures you want to position. Press Locate to turn them on. Press the palette button where your palette is stored. The Macs should move to the position you programmed earlier.

Copyright Avolites Limited 2010



---

---

## 5. Shapes

In this chapter: how to use the shape (effects) generator

- selecting a shape
- positioning
- setting size and speed
- using shapes with multiple fixtures

The Diamond, in common with other Avolites consoles, has a shape generator (sometimes known as an Effects Generator on other consoles). This allows you to quickly create exciting light shows with lots of movement and changes, using the minimum amount of programming.

There are a large number of pre-programmed shapes available, which can be used on the fixture's position, colour, gobo, dimmer, iris, focus and more. You can control the size, speed and positioning of the shape, and how the shape is allocated across a range of fixtures.

To understand how shapes work and how they can be spread across multiple fixtures, it's best to set up at least four fixtures next to each other. Once you have mastered the basics, you can try some more interesting arrangements.

### 5.1 How shapes work

A shape is a pre-programmed movement sequence which usually repeats over and over again. Typical shapes are circles, spirals, squares, waves, etc. A circle shape, for example, would cause the beam of the fixture to move in a circular path on the stage.

When you apply a shape, it works based on the current settings of the fixture. So if you apply a circle to the pan and tilt attributes of a fixture, the centre of the circle will be at the current pan and tilt position. You can change the size of the circle, and the speed of the circle. By moving the pan and tilt position of the fixture, you can move the whole shape around the stage.

Shapes can be applied to other attributes of a fixture, not just pan and tilt. You can use them to create colour changes, gobo changes, iris changes and a variety of other attributes. Each shape is designed to modify one particular group of attributes.

### 5.2 Selecting a shape

To select a shape you simply pick it from a list on the softkeys. Shapes are listed using the IPCGBES attribute groups, so you can pick from a list of Intensity shapes, or a list of Pan/Tilt shapes, or Colour shapes, and so on. You can also pick from a list of All Shapes.

When you choose a shape, it will be applied to all selected fixtures.

### Selecting a shape

- 1> Select the fixtures you want to apply the shape to by pressing the Select buttons. In this example we will apply a position shape, so the fixtures will need to have pan & tilt attributes.
- 2> Press Shift and Locate to turn on the fixtures and move them to a central position.
- 3> Press the Shape button (to the right of wheel 3).
- 4> Press A [Create] to start a new shape.
- 5> Press B [Pan/Tilt] to look at the list of Pan & Tilt shapes.
- 6> Press I [Circle] to select a circle shape.
- 7> The shape will be applied to all selected fixtures.



Shape button

There are a wide range of different shapes available for each attribute; use Softkeys I and J to look through the different pages.

"Rainbow" shapes only work on fixtures capable of CMY colour mixing, and there are other shapes such as Iris and Focus which will only work if your fixtures have those functions.

The best way to find out what all the shapes are like is to try them out. Sometimes it's hard to describe the effect in the few letters which fit on the display.

## 5.3 Changing size and speed of a shape

It is easy to change the size and speed of a shape after it has first been selected.

### Changing the size and speed of a shape

- 1> Control the speed of the shape using wheel 4.
- 2> Control the size of the shape using wheel 5.
- 3> The size and speed is shown above the wheels on the display.

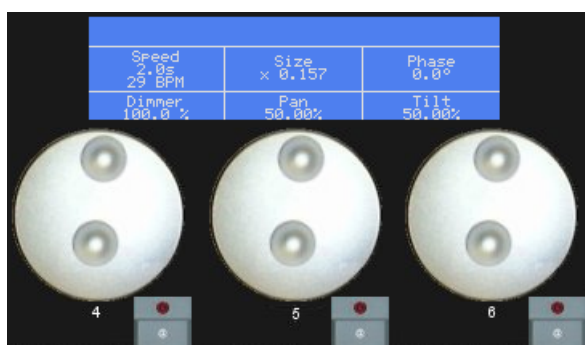

The minimum size is zero. Obviously, you won't see the shape, and the fixture will resume its previous settings.

If you change fixture attributes while a shape is running, the wheels will

change to control the fixture attributes. You can get the Shape controls back again by pressing the "Soft Key" button at the right hand end of the attribute buttons.

## 5.4 Editing and deleting a shape

You can have a number of different shapes running at once. When in the Shape menu Softkey B [Edit] allows you to select which shape is currently being controlled by the wheels. All active shapes are displayed above the softkeys, press a softkey to make that shape the current shape. The selected shape is highlighted on the display.

You can delete shapes using softkey C in the Shape menu.

---

### ***Deleting a shape***

- 1> *Press Shape, if you aren't already in the Shape menu.*
  - 2> *Press C [Delete].*
  - 3> *A list of active shapes is displayed above the softkeys.*
  - 4> *Press the key for the shape you want to delete.*
- 

## 5.5 Changing the positioning of a shape

Shapes are based on the current settings of the fixture. This means that for a position shape, movements will be centred around the current position of the fixture.

---

### ***Changing the positioning of a shape***

- 1> *Select the fixtures you want to change.*
  - 2> *Use the Size/Speed wheels to reduce the shape size to 0 (it's difficult to see the position when everything is moving).*
  - 3> *Set the position using the Pan and Tilt wheels.*
  - 4> *Using the Size/Speed wheels, change the size of the shape back to where you want it.*
- 

If the Size of a shape is set to be large, the shape will go from the maximum to minimum settings of the attribute and you may not see the current position. Reduce the Size to zero or a small value to see the effect of the current position.

## 5.6 How a shape works across multiple fixtures

Shapes get more interesting (and look more impressive) when you apply them to multiple fixtures. The Diamond lets you set how a shape is phased across several fixtures. This is great for creating instant "wave" or "ballyhoo" type effects.

The display above Wheel 6 shows the phase in degrees, and below that, the number of fixtures before the shape repeats. For example, 180 degrees repeats every 2 fixtures, 90 degrees repeats every 4 fixtures, 60 degrees repeats every 6 fixtures, and so on. You'll need to apply the shape to at least 4 fixtures to see the effect of phase.

---

### ***Changing the Phase of a shape***

- 1> *Set the phase using wheel 6.*
- 2> *You can type in a value for the phase by pressing the "@" button*

*below wheel 6 and enter the value on the numeric keys.*

3> *Or, if you want the shape to repeat every 4 fixtures, press @, type 4 and press A [Set Part].*

---

Note: The order in which you select the fixtures determines how the shapes are applied; the "first" fixture is the one you select first and the "last" fixture is the one you select last. If you use a group to select the fixtures, it uses the order in which you selected the fixtures when you saved the group. You can change this order later, see section 5.2.2 on page 157.

You can also set an "Initial Offset" which will make the shape start part way through its pattern. This can be useful when running multiple shapes, if you don't want them all in sync with each other. Initial Offset is found on Wheel 4 on the second page of the shape properties – press the Soft Key button to show the second page.

## 5.7 Examples

### ***How do I make my Mac600's wave around in a trendy manner?***

Select the Mac600's by pressing the select buttons. Press Locate to light them up. Press Shape (just above locate). Press A [Create]. Press B [Pan/tilt] to look at the list of position shapes. Then press H [Circle]. The fixtures will move. Turn wheel 6 until the phase is set to 90 degrees; this will spread out the movement of the fixtures. Use Wheel 4 to set the shape speed. Use wheel 5 to set the shape size.

### ***How do I make my Mac600's change colour in a rainbow?***

Select the Mac600's by pressing the swop buttons. Press Locate to light them up. Press Shape (just above locate). Press A [Create]. Press C [Colour] to look at the list of colour shapes. Keep pressing J [More] until you see the option [Rainbow] (not Rainbow RGB, which is for LED fixtures). Press the softkey for that shape. The fixtures will change colour. Use wheel 6 to set the phase to zero to make all fixtures do the same colours, or change the phase to make them do different colours. Use Wheel 4 to set the colour cycling speed. Use wheel 5 to set the range of colours used. Note: Rainbow shapes only work with fixtures capable of CMY colour mixing.

## 6. Cues

In this chapter: how to record cues into the playback faders

- explanation of HTP and LTP channels
- how the Diamond works when programming
- recording and playing back cues
- playback pages
- setting legends for cues
- setting fade times for cues
- copying and deleting cues
- the include function
- editing cues
- record by fixture, channel, mask or stage

So, you now know how to control your dimmers and fixtures, and how to use the shape generator. This chapter tells you how to record the wonderful effects you have created so that you can recall them at the touch of a button or fader. The Diamond 4 Vision has 28 playback faders (Diamond 4 Elite has 14) across the bottom of the desk, into which you can record your effects. You select a different page of playback faders using the page select buttons.

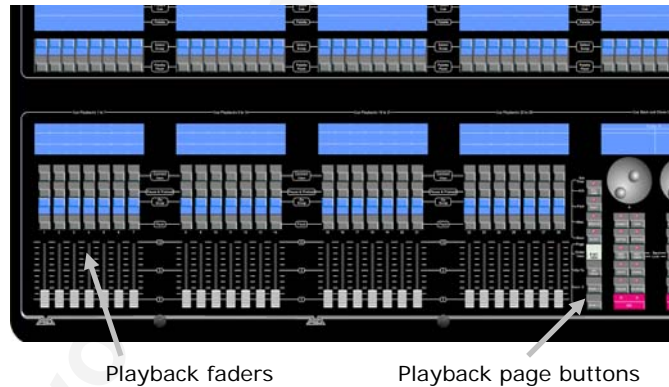

Before we get onto the details of recording cues, there are a couple of general things about how the Diamond works. The first thing to understand is what happens when you play back more than one cue at a time. It's important to understand this before going on, or nothing else will make sense.

### 6.1 What are HTP and LTP channels?

If two or more cues are turned on together, or if you fade out a cue, the Diamond needs to know how to output the levels from the cues. To make this work the Diamond treats channels which control intensity differently from other moving light control channels.

Dimmer or intensity channels work on the principle of "Highest Takes Precedence" (HTP). This means that if the same HTP channel is turned on at different levels in several cues, the highest level will be output. When you fade a cue out using the playback fader, the HTP channels in that cue will fade to zero (or to the next highest level if other cues are fired).

Moving light channels work on the principle of "Latest Takes Precedence" (LTP). This means that the latest change takes over from any other values, so the most recent cue to be turned on is the one

which is output. When you fade in a cue, LTP channels do not normally fade, but come on at their full values, and stay there until another value is set. This is important, because when you fade in a cue you normally just want the fixtures to fade up in their proper position, colour and gobo, you don't want the fixtures moving and changing colour (though you can do this using fade times if you need to). When you fade out a cue, the LTP channels just remain in their last position.

The fixture personality file tells the Diamond which attributes of a fixture are Dimmer attributes and it treats these as HTP. All other attributes are treated as LTP.

## 6.2 The Editor and Programmer

When you select one or more dimmers or fixtures for control, they are loaded into the Editor. You can then use the wheels, palettes and the @ button to edit the settings on the fixtures. You can also apply shapes.

Once you have changed some attributes, the next time you select a fixture a new selection is started. The previous selection is stored in a "Selection Group". You can go back through previous Selection Groups using Shift and the ← → buttons to the right of wheel 3.

All fixtures and attributes that have been edited since the last Clear are stored in the Programmer. The order in which you selected the fixtures is also stored, and is used with the Fixture Overlap function. When you record a cue, the contents of the programmer are saved into the cue.

When you press Clear (by the numeric keypad), the programmer and editor are emptied. You should get into the habit of pressing Clear before you start to program a cue, or you can end up recording fixtures you don't want. You also need to press Clear when you finish programming, because any attributes in the programmer will override playbacks.

Fixtures which are in the programmer are shown in light blue on the VDU Stage View. Attributes in the programmer (the things you have changed) are shown in cyan on the VDU Stage View screen. Also, fixtures which are in the programmer have their numbers inverted on the LCD screens. (In this picture, Macs 7-11 are in the programmer and 10 & 11 are currently selected).

26	29	27	28	29	30	31	32
Mac	Mac	Mac	Mac	Mac	Mac	Mac	Mac
2000P	2000P	2000P	2000P	2000P	2000P	2000P	2000P
7	8	9	10	11	12	13	14
0%	0%	0%	0%	38%	0%	0%	0%
All						Shutt	Strbe
Out						Open	Rndm
P						I	I

Note: Firing a cue does not place the values from the cue in the programmer (the Include function lets you do this, see page 50). The Locate function does not place any values in the programmer either.

In the stage view screen shown here, the Locate function has been used on fixtures 1 to 8, then the pan value has been changed on fixtures 3 to 6. Only the changed pan value is in the programmer. The dark blue highlighting shows which fixtures are selected. The IPCGBES column shows which attribute groups have been changed. The light blue highlighting shows fixtures which are in the programmer (ones which have been selected since Clear was last pressed).

Name	Handle	IPCGBES	Dimmer	Pan	Tilt	Colour	Iris	Effect
GoldnScan3 1	121		100.0 %	50.00%	50.00%	Open	Open 100%	Open
GoldnScan3 2	122		100.0 %	50.00%	50.00%	Open	Open 100%	Open
GoldnScan3 3	123	P	100.0 %	42.17%	50.00%	Open	Open 100%	Open
GoldnScan3 4	124	P	100.0 %	42.17%	50.00%	Open	Open 100%	Open
GoldnScan3 5	125	P	100.0 %	42.17%	50.00%	Open	Open 100%	Open
GoldnScan3 6	126	P	100.0 %	42.17%	50.00%	Open	Open 100%	Open
GoldnScan3 7	127		100.0 %	50.00%	50.00%	Open	Open 100%	Open
GoldnScan3 8	128		100.0 %	50.00%	50.00%	Open	Open 100%	Open

## 6.3 Recording a cue

So now that is all out in the open, let's record a cue.

### **Recording a cue**

- 1> Press Clear to clear the programmer. This ensures that you are starting with a clean slate.
- 2> Set up a nice effect using the fixtures and dimmers. You can include shapes in a cue if you want. Remember! Only the fixtures/dimmers you have changed will be recorded in the cue.
- 3> Press Rec Cue (below softkey D).
- 4> Press the Go/Swop button of an empty playback fader you want to use.
- 5> The display above the fader will change to show that you have saved a cue there.
- 6> You can set a legend for each cue which is shown on the display above the fader in the same way as for Palettes (see page 37).
- 7> Press Clear to clear the programmer.

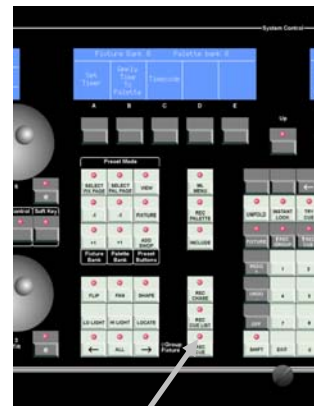

Rec Cue button



If you'd rather have it all on one page for instant access, you can also record cues into any unused preset faders. The preset fader then works like a playback fader.

You can press Softkey E [Press to latch menu] which allows you to keep saving cues without having to keep pressing the Rec Cue button. If you do this, you need to press Up to leave Record Cue mode.



## 6.4 Playing back a cue

Playing back (firing) a cue is very simple. Just raise the fader. (Make sure there are no values in the programmer by pressing the Clear button, because anything in the programmer will override the playback).

### *Playing back (firing) a cue*

- 1> Raise the playback fader.
- 2> To stop the cue, lower the fader.

All the HTP (intensity) channels in the cue will fade up with the fader. The output level of the HTP channels will be mastered by the fader; if you only put the fader to 50%, all the HTP levels will be 50% of their programmed value.

The LTP (movement) channels will be set as soon as the fader leaves the zero position (actually when it passes 3%) and are not normally affected by the fader position. If you need to move the LTP channels with the fader, set the cue to mode 2 (see section 6.7.1 on page 167 in the reference manual).

You can also press the Flash button above the fader to turn the cue on instantly. The cue will turn off again when you release the button.

When you're running your show, you can preload the LTP channels (pre-position the fixtures) by pressing the Pause & Preload button above the fader. This can be useful if you want to position the fixtures in blackout and have them ready to turn on, rather than seeing them wobble into position if you put the fader up quickly.

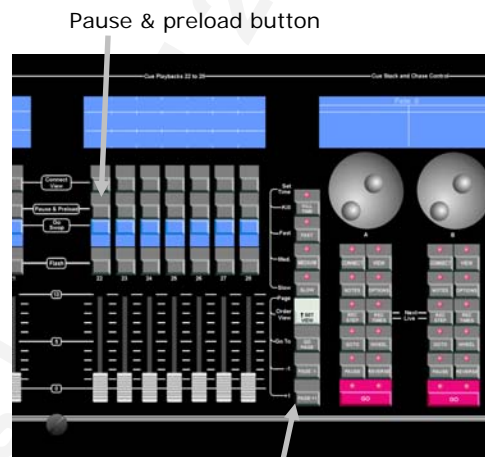

Playback page buttons

## 6.5 Changing playback pages

You can change pages to select another 28 cues (14 on the Elite) using the Page-1 and Page+1 buttons to the right of the last playback fader. Also you can press Go Page which will present all pages you have created on the softkeys for instant selection, or you can enter the new page number on the numeric keypad.

If any playbacks are fired when you change page, they remain active. The display above the playback shows you the running cue from the previous page, then above that, the cue from the new page. The arrow shows if the running cue is from a page above or below the current page.

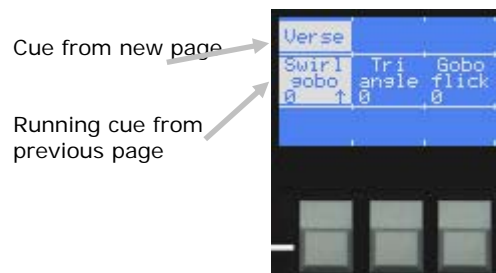



If you want to use the same playback fader on a new page, you need to lower it to zero to kill the first playback, then raise it again to fire the new playback on the new page. The legend for the cue on the new page will drop down to the normal position.

If you have playbacks on the preset faders, you use the Fixture Bank buttons to change pages (below Softkey A).

You can lock a playback so that it will appear on all pages. See page 163 for more details.

## 6.6 Setting a legend for cues

The display above each playback fader allows you to set a legend for each cue, so you can see at a glance what is stored in each fader.

### **Setting a legend for a cue**

- 1> Press the blue Set Legend button (bottom right of console).
- 2> Press the Go/Swap button of the playback you want to legend.
- 3> Enter the text using the keyboard. You can enter 2 lines of 6 letters.
- 4> The display above the playback fader shows you what you are typing. The display above Softkey C also shows you your text and how it will be formatted.
- 5> Press Enter to save the legend.

The number shown next to the legend is the timing Mode of the cue. See page 167 in the reference manual for more information about cue modes.

If you have lots of legends to set, E [Press to Latch Menu] will keep the Set Legend menu active so you don't have to keep pressing Set Legend.

You can also set a legend for the playback page by pressing A [Set Page legend] from the Set Legend menu. The page legend is shown above the Cue Stack control wheels.

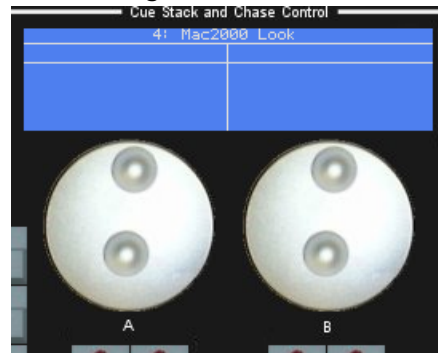

## 6.7 Copying a cue

Copying a cue is very fast and simple.

### **Copying a cue**

- 1> Press the blue Copy button (bottom right of console).
- 2> Softkey B [Press to Include Legend] or [Legend Included With Copy] lets you set whether the legend will be copied with the cue.
- 3> Press the Go/Swap button of the cue to be copied.
- 4> Press the Go/Swap button of the playback (or the Select/Swap button of the preset fader) you want to store it in.
- 5> E [Press to latch menu] keeps the Copy mode active, so you can keep copying things without having to keep pressing the Copy button. Press Up to leave Copy mode.

The new cue is a separate copy of the old one. Copies are not linked to

each other. If you want to create a linked copy you can do this by holding down the Flash button of the cue to be copied, instead of pressing its Go/Swop button. If you make any changes to a linked copy, all the copies will change too.

## 6.8 Deleting a cue

If you want to delete a cue so you can store something else in it:

---

### *Deleting a cue*

- 1> Press the blue Delete button.
  - 2> Press the Go/Swop button of the playback you want to delete.
  - 3> Press the Go/Swop button again to confirm the delete.
- 

Warning: You cannot undo deletion of a cue, once it's gone, it's gone.

## 6.9 Editing cues

You can edit any part of a cue you have already saved simply by making the changes and saving the new information on top of the cue.

---

### *Editing a cue*

- 1> Press Clear to empty the programmer.
  - 2> Fire the cue you want to edit, so you can see what you are doing.
  - 3> Select the fixtures you want to change, and make the changes.
  - 4> Press Rec Cue.
  - 5> Press the playback Go/Swop button for the cue you are editing to save the changes.
  - 6> The cue will be updated with your changes.
- 

The changes you have made are saved into the cue. None of the other information in the cue is affected.

If you want to replace the cue with a new cue, delete the old cue from the playback first.

If you need to remove fixtures or individual attributes of fixtures from the cue, you can use the Off function to do this. The Off function is described in the reference manual in section 6.3.3 on page 165. You can also use the Shift+Off function (called On) to put removed fixtures or attributes back into cues.

## 6.10 The Include function

Sometimes it's useful to be able to re-use some aspects of a cue you have already created in another cue. If you've created a really nice pattern of criss-crossing light beams, for example, you might want to use it again in another cue with different gobos and colours.

Normally when you play back a cue, the information is not loaded into the programmer, so you can't simply fire a cue, modify it and save it to a new cue. The Include function lets you reload a cue back into the programmer. You can then use it in a new cue.

The Include function loads selected attributes of selected fixtures into the programmer. So, for example, if you have a cue which contains position, colour and gobo information for 8 fixtures, you can use the Include function to load only the colour information for 4 of the fixtures

into the programmer. You could then Include position information from another cue into the programmer and so build up a new cue using information from several existing cues.

---

### Using Include

- 1> Press the Include button (below softkey D).
- 2> Press the Go/Swap button for the cue you want to use.
- 3> Select the fixtures from which you want to take settings. All fixtures used in the cue are automatically selected by default, so you just need to deselect the ones you don't want to use.
- 4> Use the softkeys to select which attributes will be used. Buttons I and J let you turn them all on or off. By default, the attributes currently used in the cue are On.
- 5> Press Enter.
- 6> The selected attributes of the selected fixtures will be loaded into the programmer.

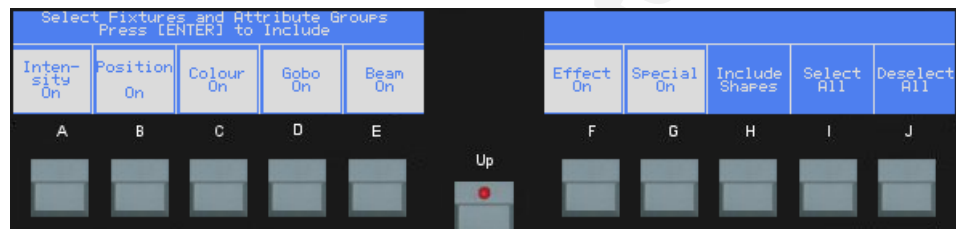

If you don't change any options, all attributes of all fixtures in the cue will be Included.

If the cue you are including contains shapes, you can select whether the shapes will be Included using softkey H.

Include is also useful when you are programming chases and cue lists, which is described in the next section.

## 6.11 Setting fade times for a cue

You can set a fade in and fade out time independently for every cue. When you fire the cue or kill it, the console will fade the cue in or out with the time you programmed.

---

### Setting fade times for a cue

- 1> Press A [Set Times] (if option A is not [Set times], press Shift+Up to get the top level menu).
  - 2> Press the Go/Swap button of the playback you want to set times for
  - 3> The display shows you the times you can set.
  - 4> Press C to set Fade In time, or D to set Fade Out time.
  - 5> Use the numeric keypad to enter the new time. Press Enter to save it.
  - 6> Press Up to leave Set Times mode.
-

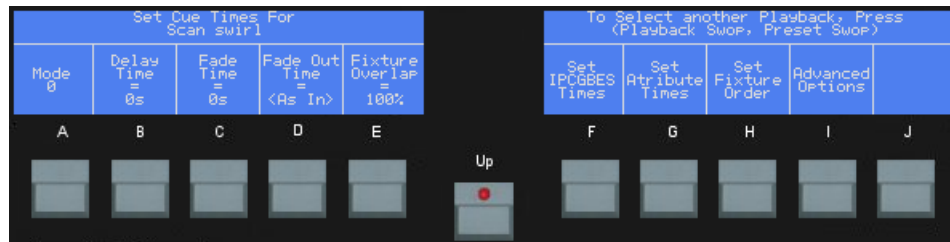

Cues can be set to Mode 0, 1, 2 or 3 (Softkey A) which affects how the fade will operate. This, and the many other timing functions available, are described in the reference manual on page 167.

## 6.12 Record by fixture, channel, mask or stage

Normally, if you change just one attribute of a fixture the Diamond records all the attributes of that fixture even though you haven't changed those attributes. So if you change the pan position, the Diamond will also record the tilt, colour, gobo, iris, and so on. However, the Diamond also has more selective modes of operation where it only records the changed attributes. You can choose the mode using Softkeys G, H, I and J when recording a cue.

- I - Record by fixture:** This is the normal mode of the Diamond. It means that when you record a cue, all attributes of every fixture in the programmer are recorded in the cue. So if you change only the position of a fixture, the colour, gobo, intensity and all other attributes of that fixture are recorded as well (just selecting a fixture puts it in the programmer, you don't have to change anything). This is useful because you know that when you recall the cue it will look exactly as it did when you saved it. However, it can be slightly inflexible if you want to combine cues.
- H - Record by channel:** This means that only attributes you have changed are recorded in the cue. So if you change the position of a fixture, only the position is recorded. When you recall the cue, the colour, gobo etc will remain as they were last set. This means you can use a cue to change the position of some fixtures while leaving the colour set by a previous cue, allowing more variety when you are running a show. It is a powerful feature but you can easily get yourself into trouble with it so you need to be sure which attributes you want to record and which you want to "show through". When you're learning, it's best to record some cues using Record by fixture which set the fixtures to a known state, then have some colour cues to modify just the colour, or some gobo cues to set the gobo, or other attributes.
- G - Record by Mask:** You can select which attributes will be recorded in the cue, using the IPCGBES attribute groups. Above Softkey G [Record by Mask] the display shows you which attributes are going to be saved. Press G again to change the attribute selection.
- J - Record Stage:** The Diamond will record all fixtures or dimmers which are either in the programmer, or which are lit (have intensity above zero). The cue will contain the actual output values at the time; if you have used Palettes to set the look, the palettes are not stored.



Internally the Diamond actually records all output from the console in every cue regardless of the mode, but it ignores unwanted output using the "Off" function. This means you can recover settings later if you use the wrong mode. See section 6.3.4 on page 165 in the reference manual for more about this.

## 6.13 Using shapes in cues

As you would expect, any shapes you have set up will be saved as part of the cue. If you are using Record by Channel mode, there are some interesting possibilities.

If you have changed the position of the fixture, then the new position will be stored in the programmer. When you recall the cue, the fixture will start the shape at the position you set in the cue.

If you have not changed the position of a fixture, when you recall the cue the shape will run starting at the current position of the fixture. This allows you to make a "shape only" cue which overlays shapes on the current positioning of the fixtures.

## 6.14 Examples

### *How do I save my dimmer settings on a fader as a cue?*

Press Clear to remove any changes you've made so far. Set the dimmers as you want them using the preset faders. The display below the dimmer channels should invert to show you that the dimmers are now in the programmer (if the "Preset Fader Selects Fixture" user setting is turned off, you will have to select the dimmers yourself by pressing their Select buttons). Press Rec Cue. Press the Select button of an empty fader where you want to save the cue. You can save cues in playback faders (across the bottom left) and preset faders (across the top of the console).

### *Why don't my Mac 600's move to the position I've programmed when I fire a cue?*

You have not pressed clear since you positioned the fixtures for another cue, so the Mac600 positions are held in the programmer. The programmer overrides cues. If you press Clear your cues should work.

### *How do I save a cue containing only the positions from another cue?*

Press Include (below softkey D), then the swop button of the cue you want to take positions from. All fixtures in the cue are selected, deselect any you don't want. Press J [Deselect All]. Press B until the option shows [Position On]. Press Enter. The position information for the selected fixtures will be recalled from the cue. Then save the cue by pressing Rec Cue and an empty Swop button.

Copyright Avolites Limited 2010

## 7. Chases

In this chapter: how to use chases

- explanation of chases
- programming a chase
- running a chase
- setting speed and crossfade
- editing a chase using Unfold
- copying and deleting chases

### 7.1 What is a chase?

A chase is simply an automatic sequence of cues. It is normally used to flash lights in a sequence or to change fixtures in a sequence without you having to keep pressing buttons. You can set a speed and a crossfade setting which the Diamond uses when moving from one cue to the next. You can also set individual timings for cues in chases if you want to.

Don't get shapes confused with chases. A shape simply moves one attribute of the fixture around in a pattern. A chase allows you to define each attribute of the fixture in a controlled step-by-step manner.

However, you will find that using shapes can save you a lot of work, and you won't have to program as many chases as you would on a conventional lighting desk.

### 7.2 Recording a chase

To program a chase, you have to set up the lighting state for each cue in the chase. You can either set all the fixtures and dimmers manually for each cue, or you can use Include to load in the information from cues you have already recorded. Remember, if you just fire a cue, it does not go into the programmer and won't get saved as part of a chase unless you use Record Stage mode or Include.

#### **Programming a chase**

- 1> Press the Rec Chase button.
- 2> Press the Go/Swap button of the playback where you want to store the chase.
- 3> Press Clear, then set up the lighting for the first cue, either manually or by using "Include" on existing cues (see section 6.10 on page 50). You can save shapes in chase cues.
- 4> The display above softkey A shows the number of the cue currently being programmed; the top line of the display shows how many cues are stored in the chase.
- 5> Press the playback Swap button or A [Append Cue 1] to record the cue. The information from the programmer is stored as Cue 1

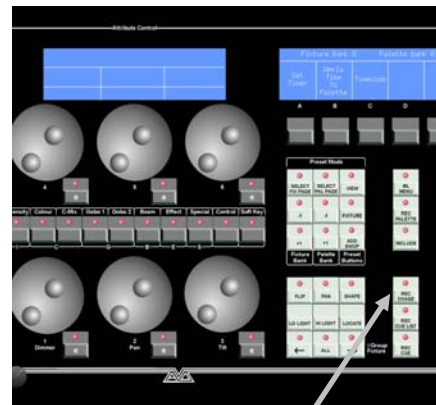

Rec chase button

of the chase.

- 6> Set up the lighting for the second cue, then press Swop or A again to save cue 2.
- 7> If you get a cue wrong you can press C [Insert Cue] then type the cue number you want to change on the number keys. The existing cue is overwritten. You can also insert cues between existing cues (such as cue 2.5 between cue 2 and cue 3) using C [Insert Cue].
- 8> When you have saved as many steps as you want, press Clear, then press Exit or Up to finish.

Remember to press Clear at the end of programming, or the settings for the last cue will remain in the programmer and will override the chase when you load it, so you won't see the chase properly.

### 7.3 Running a chase

Just raise the playback fader and the chase will start to run. This is known as firing a chase.

You can pause the chase by pressing the Pause & Preload button above the fader. The Go/Swop button will continue the chase.

The most recent chase will be automatically "connected" to the Chase Controller A wheels and buttons. These allow you to change the settings of the chase. If you want to connect a different chase to Chase Controller A or B, press the Connect button of the controller (just below the wheel) then the Connect/View or Swop button above the fader of the chase you want to connect.

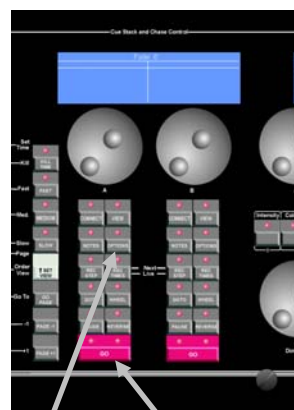

Options button Chase controller buttons

The HTP (intensity) channels in the chase will be mastered by the position of the fader; in other words if you set the fader at 50% then all HTP channels will run at 50% of their programmed levels. The other channels (LTP) will be set as soon as the fader moves above zero. You can pre-position the LTP channels to the first cue in the chase by pressing the Preload button of the playback.

### 7.4 Setting speed, fade and other chase options

You can change the Speed and Crossfade (Xfade) of the chase.

Crossfade is the "slope" between cues; with a crossfade of 0, the fixtures snap instantly to the next cue, but with a crossfade of 100, the fixtures spend the whole cue time fading to the next cue. With a crossfade of 50, the fixtures delay for half the cue time and fade for the other half of the time.

The following picture illustrates how crossfade works.



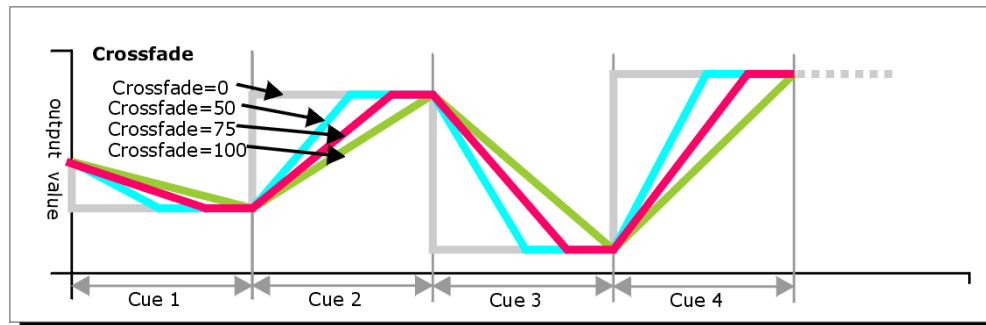

---

### Setting chase speed and crossfade

- 1> Fire the chase you want by raising the fader.
  - 2> Press Rec Times on the chase controller.
  - 3> Press C [Speed] to change the speed.
  - 4> Type the speed you want in Beats Per Minute and press Enter (you can change this to Seconds in the user settings).
  - 5> You can also press C twice from the Rec Times menu to "tap" the chase speed.
  - 6> Press B [Xfade] and type the fade from 0 – 100 to set the crossfade. 0=no fade, 100=max fade.
- 

You can also change the speed by turning the wheel of the chase controller.

When you are recording a chase, you can record by Channel, Fixture, Mask or Stage as with cues. This allows you to make chases which only control certain attributes of the fixtures, and leave the other attributes unaffected. See section 6.12 on page 52 in the Cue chapter for an explanation of how this works.

The chase normally starts at cue 1, and runs forward. You can change the direction of the chase by pressing the Reverse button on the chase controller. To set other options for how the chase runs, press Options on the chase controller. Softkey B [Stop On Last Cue] makes the chase run once and stop, or to make it bounce (run forward to the end, then backwards back to the start), press C [Bounce].

There are also Overlap options which allow you to overlap the current cue with the next cue in various ways to create astounding effects from mundane chases. Rather than all fixtures moving to the new position at the same time, you can make them move one after the other. Overlap is explained in the reference manual in section 6.7.1 on page 180.

## 7.5 Setting legends for chases

You can set a legend for chases in exactly the same way as you did for a cue. In addition, you can set a legend for individual cues of a chase by using the Unfold function described in the next section.

---

### Setting a legend for a chase

- 1> Press the blue Set Legend button (bottom right).
  - 2> Press the Swop button of the playback you want to legend.
  - 3> Enter the legend using the keyboard (the legend will appear above the fader and above Softkey C as you type) and press Enter..
-

## 7.6 Editing a chase using Unfold

The Diamond has a powerful chase editing system. The Unfold function places each cue in a chase on one of the playback faders, allowing you to examine and edit each cue individually as if it was a normal stand-alone cue.

If your chase has more cues than the console has playback faders, you can change pages using the playback page+1 and page-1 buttons.

---

### ***Editing a chase using Unfold***

- 1> *Press the Unfold button (above the numeric keys).*
  - 2> *Press the playback Swop button of the chase to be edited.*
  - 3> *The chase cues are loaded into the playback faders.*
  - 4> *Raise a playback fader to view the contents of any cue.*
  - 5> *To edit the contents of any cue, make the changes then press A [Record] then the Swop button of the playback for that cue (or type the cue number on the numeric keys and press Enter).*
  - 6> *You can change the timings of individual cues in the chase using B [Set Cue Times] (see reference manual page 180 for details).*
  - 7> *To change the times for the whole of the chase, use softkey G [Set chase times].*
  - 8> *Press the Unfold button again to finish.*
- 

The other softkeys allow you to insert, delete or copy cues in the chase. This is described in the reference manual.

You can also edit chase cues while you are running the chase, without using unfold. The "Rec Step" button allows you to record the current programmer settings directly into the current cue of the chase. This is described in more detail in the reference manual.

## 7.7 Copying a chase

Chases can be copied in exactly the same way as cues.

---

### ***Copying a chase***

- 1> *Press the blue Copy button (bottom right).*
  - 2> *Press the Go/Swop button of the chase you want to copy.*
  - 3> *Press the Go/Swop button of the playback you want to store it in*
  - 4> *You can change page after pressing the first Swop button if you want to copy a chase to a different page.*
- 

Copied chases are not linked to the original. You can create a linked copy of the chase by holding down the Flash button of the chase to be copied instead of the Go/Swop button.

## 7.8 Deleting a chase

If you want to delete a chase:

---

**Deleting a chase**

- 1> Press the blue Delete button (bottom right).
  - 2> Press the Swop button of the chase you want to delete
  - 3> Press the Swop button again to confirm the delete.
- 

You cannot undo deletion of a chase.

## 7.9 Examples

***How do I program a dimmer chase?***

Create the chase by pressing Rec Chase then a swop button of a vacant playback or preset. Press Clear, and turn on the dimmers for step 1. Press A [Append Cue] to save the step. Press clear, then turn on the dimmers for step 2, and press A to save. When you have saved all the steps, press Shift and Up to end.

***I've programmed a chase from some existing cues but when I fire it, nothing happens***

To use existing cues in a chase, you must use the Include function to load the cue into the programmer. If you just fire a cue and then try and save that as a chase step, nothing will be saved because the cue will not be in the programmer (you can also use Record Stage mode to use existing cues in a chase).

***The last step of my chase doesn't play back***

After programming you need to press Clear to clear the programmer (which overrides the chase output).

Copyright Avolites Limited 2010

## 8. Cue Lists

In this chapter: how to use cue lists

- programming a cue list
- running a show using a cue list
- setting timings
- editing a cue list using Unfold

### 8.1 What is a cue list?

A cue list is a sequence of cues, each one having its own fade times and being triggered by the Go button. You can program all the cues for your show into a cue list and run the show simply by pressing one button. This is ideal for complex theatrical shows where the show has to run the same night after night.

In addition, you can tell the console to automatically trigger other playbacks when a cue is run. These are called Autoloads and allow complex sequences to be operated from the cue list.

Cue lists differ from chases in the way the console handles changes between cues. Chases will crossfade between cues whereas a cue list will track changes. For example: You record dimmer 1 in cue 1, press clear, record dimmer 2 in cue 2, press clear, record dimmer 3 in cue 3.

If this were a chase, when you play it back each cue would fade out the dimmer from the previous cue, so once you get to cue 3, you would only have dimmer 3 active.

If it was a cue list, when cue 2 fades in, dimmer 1 would not fade out as there is no data about dimmer 1 in cue 2. This means that once you get to cue 3, it would have accumulated the data from all the cues and the output would consist of dimmers 1, 2 and 3 together.

If you wanted cue 2 to turn off dimmer 1, you would have to explicitly set the level of dimmer 1 at zero (by selecting it and setting the Intensity to 0); or you can miss out pressing Clear in between saving each cue.

### 8.2 Recording a cue list

To record a cue list, you simply set up the look for each cue. You can either set all the fixtures and dimmers manually for each cue, or you can use existing cues. The first example shows you how to create the cues in the cue list from scratch, the second shows you how to create a cue list from existing cues.

#### **Creating a Cue List**

- 1> Press the Rec Cue List button.
- 2> Press the Go/Swap button of the playback where you want to store the Cue List.
- 3> Press Clear, then set up the lighting for the first cue.

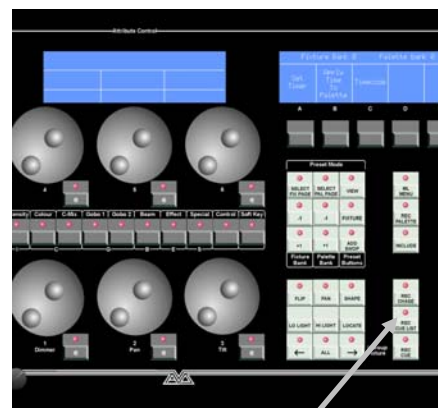

Rec cue list button

- 4> *The display above softkey A shows the cue number of the cue currently being programmed, the top line of the display shows how many cues are stored in the cue list.*
  - 5> *Press J [Record Stage Hard Cue] to set the recording mode. This mode will record everything which has its intensity above zero, plus everything in the programmer.*
  - 6> *Press the playback Swop button or A [Append Cue 1] to record the step. The information from the programmer is stored as Cue 1 of the cue list.*
  - 7> *Set up the lighting for the second cue, then press Swop or A again to save step 2. Do not press Clear in between cues, as faders moving to zero will not be recorded. If you do press Clear, you need to make sure that all faders you have changed are selected (by pressing the blue Select button below the fader).*
  - 8> *To insert a cue out of sequence, or to overwrite an existing cue, press C [Insert Cue] and type the cue number to be inserted. If this is the number of an existing cue, the existing cue will be overwritten. To insert a new cue, enter a number between two existing cues (such as 2.5 to go between 2 and 3)*
  - 9> *When you have saved as many cues as you want, press Clear, then press Exit or Up to finish.*
- 

You can set times for each cue while you are recording the cue list by pressing B [Set times], which will set the times for the last cue you recorded. The various timing functions are described in the reference manual in section 6.7.1 on page 167.

---

#### ***Creating a Cue List from existing cues***

- 1> *Press the Rec Cue List button.*
  - 2> *Press A [Record List From Existing Cues].*
  - 3> *Press the Go/Swop button each existing cue you want to use, in the order you want them.*
  - 4> *Press A [Record Cue List].*
  - 5> *Press the Go/Swop button of the playback where you want to store the cue list.*
- 

## **8.3 Running a cue list**

To run a cue list you just raise the fader and use the Go button above the fader to fire cues. The fader acts as a master for the intensity (HTP) channels in the cues, so if you put the fader at 50%, all the intensities will be 50% of their programmed values.

You can also connect the cue list to one of the chase controllers, which allows you to use the large red Go button and also shows any cue list notes on the chase controller display.

---

#### ***Running a cue list***

- 1> *Press the Connect button on chase controller A.*
- 2> *Press the Connect/View button of the playback where the cue list is stored.*

- 3> Raise the fader of the cue list.
- 4> Press the red Go button to fire the cues.
- 5> The cue list fader is the master intensity fader for all cues in the cue list.
- 6> When you have finished with the cue list, press Shift and the swop button of the playback to deactivate it (otherwise the last cue remains active).

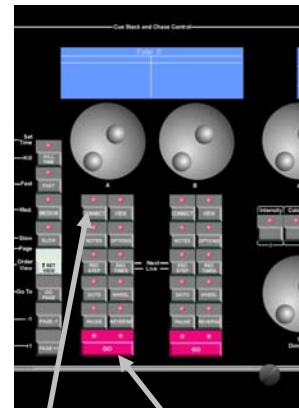

Connect button      Go button

You can press the Pause button of the controller to pause a fade (press Go to resume) or the Reverse button to go back to the previous cue using the programmed fade times.

The chase autoconnect function does not operate for cue lists.

## 8.4 Setting legends for the cue list

You can set a legend for the cue list itself and for individual cues. The legends are displayed above the playback fader and above the controller wheel.

### Setting an overall legend for a cue list

- 1> Press the blue Set Legend button.
- 2> Press the Swop button of the playback you want to legend.
- 3> Enter the legend using the keyboard (the legend will appear above the fader and above Softkey C as you type) and press Enter.

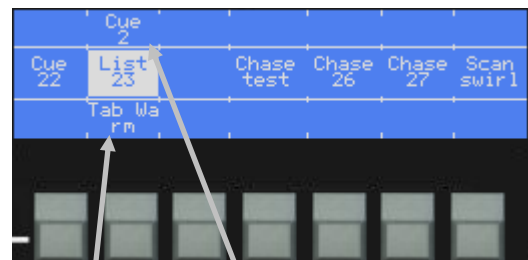

Live cue      Next cue

You can set a legend for each cue which is also displayed above the playback fader. The legend for the live (current) cue is immediately above the fader and the legend for the next cue is displayed on the top line of the display.

### Setting cue legends in a cue list

- 1> Open the cue list for editing by pressing Rec Cue List then the swop button for the cue list.
- 2> Press B [Set times] and select the cue you want to set using softkey I.
- 3> Press J [Playback options] then G [Set legend]
- 4> Type the cue legend on the keyboard and press Enter.
- 5> Select another cue to legend using softkeys I and J or press Shift+Up to finish.

## 8.5 Setting times for cues

Each cue can have its own individual timings. You can also link cues together if you want them to run on automatically.

There are two basic times: A delay time (delays the start of the cue after you have pressed the Go button) and a fade in time (over which the cue fades from the previous state to the state recorded in the cue). There are additional timing options which are described in the reference manual in section 8.7.1 on page 191.

---

### **Setting times for cues in a cue list**

- 1> *Open the cue list for editing by pressing Rec Cue List then the swop button for the cue list.*
  - 2> *Press B [Set times] and select the cue you want to set using softkeys I [Select cue].*
  - 3> *To set the delay time, press B [Delay Time], type a time on the keypad and press Enter. To set a fade time, press C [Fade Time] and enter the time.*
  - 4> *Select another cue using I or press Shift+Up to exit.*
- 

## 8.6 Editing a cue list using Unfold

The Diamond has a powerful editing system for cue lists called Unfold. The Unfold function places each cue on one of the playback faders, allowing you to examine and edit each cue individually as if it was a normal stand-alone cue.

If your cue list has more cues than the console has playback faders, you can change pages using the playback page+1 and page-1 buttons.

---

### **Editing a cue list using Unfold**

- 1> *Press the Unfold button (above the numeric keys).*
  - 2> *Press the playback Swop button of the cue list to be edited.*
  - 3> *The cues are loaded into the playback faders.*
  - 4> *Raise a playback fader to view the contents of any cue.*
  - 5> *To edit the contents of any cue, make the changes then press A [Record] then the Swop button of the playback for that cue (or type the cue number on the numeric keys and press Enter)*
  - 6> *You can change the timings of individual cues using B [Set Cue Times] (see reference manual section 8.3.2 on page 188 for details)*
  - 7> *Press the Unfold button again to finish.*
- 

The other softkeys allow you to insert, delete or copy cues in the cue list. This is described in the reference manual in section 8.3.2 on page 188.

## 8.7 Copying a cue list

Cue lists can be copied in exactly the same way as cues.

---

### **Copying a cue list**



- 1> Press the blue Copy button (bottom right).
- 2> Press the Go/Swop button of the cue list you want to copy.
- 3> Press the Go/Swop button of the playback you want to store it in.
- 4> You can change page after pressing the first Swop button if you want to copy a chase to a different page.

Cue lists copied like this are not linked to the original; however you can create a linked copy by holding down the Flash button of the cue list to be copied instead of the Go/Swop button.

## 8.8 Deleting a cue list or a cue

If you want to delete the whole cue list:

### ***Deleting a cue list***

- 1> Press the blue Delete button (bottom right).
- 2> Press the Swop button of the cue list you want to delete.
- 3> Press the Swop button again to confirm the delete.

To delete an individual cue from within a cue list:

### ***Deleting a cue from a cue list***

- 1> Open the cue list for editing by pressing Rec Cue List then the Go/Swop button for the cue list.
- 2> Press the blue Delete button (bottom right).
- 3> Type the cue number you want to delete and press Enter.

Be warned that you cannot undo either of these operations.

## 8.9 Examples

### ***How do I program the cues for my show into a cue list?***

Press Rec Cue List, then a swop button of a vacant playback or preset. Press Clear, and turn on the dimmers for cue 1 either using the preset faders or by typing the levels (e.g. 1 THRO 10 DIM@ 5 to set channels 1-10 at 50%). Set up any fixtures you are using. Press A [Append Cue] to save the cue. Set the fade times for cue 1 using B [Set times]. Press clear, then turn on the dimmers for cue 2, and press A to save. When you have saved all the steps, press Shift and Up to end.

To run the cue list, press Connect on chase controller A, then the swop button of the cue list. Raise the fader, then press the Go button on controller A to start the first cue. The fader sets the master levels for the cues.

### ***They want to add in another cue between 5 and 6, how do I insert a cue?***

Press Rec Cue List, then the swop button of the cue list. Press Clear, then set up the dimmers and fixtures for the new cue. Press C [Insert Cue] then enter "5.5" on the keypad and press Enter. A new cue will be created between 5 and 6. Press B [Set Times] to change the times for the new cue.

Copyright Avolites Limited 2010

---



---

## 9. Running your show

In this chapter: running your show with the Diamond 4

- Showtime
- Master faders
- Manual control during a show (busking)

### 9.1 It's showtime...

At regular intervals during your programming, and especially when you have finished programming (or you've run out of time) and it's showtime, the most important thing is to back up the show to USB pen drive or CD. Even saving it as a new file on the internal disk is better than nothing (see end of section 2.9 on page 25 for instructions).

If your show is being operated by a lesser mortal, turn the key to Safe and remove the key. This prevents anyone from altering the programming of the console.

### 9.2 Master faders

Master faders are used to control the overall output of the console, for example if you want to fade down everything, or just fade the preset faders.

The Diamond does not have dedicated Master faders, but allows you to assign one or more of the playback faders as Master faders.

---

#### ***Assigning master faders***

- 1> Press J [*Utils*].
  - 2> Press C [*Set Masters*].
  - 3> Select type of master fader (*Grand, Playback, Flash, Preset, Swop*).
  - 4> Press the Go/Swop button of a playback to assign that fader as a Master.
  - 5> Keep pressing Up until the button light goes out to return to the root menu.
- 

- **Grand Master** controls the output level of the entire console.
- **Playback Master** controls the overall level of playback faders.
- **Flash Master** controls the level of cues fired with the Flash buttons.
- **Preset Master** controls the overall level of the Preset faders.
- **Swop Master** controls the level of cues fired with the Swop buttons.

Any Masters which are not assigned to faders are fixed at 100%, so you don't need to assign master faders if you don't need them.

### 9.3 Flash and swop buttons

The Flash and Swop buttons on the playback faders may be used to

flash and solo cues and chases. The Flash button adds the playback into the current output, the Swop button turns off all output except its own playback.

You can also flash and swop individual fixtures or dimmer channels using the Select/Swop and Palette/Flash buttons below the preset faders. To use them for this, you need to enable Add and Swop mode by pressing the Add/Swop button below softkey B. In Add/Swop mode you cannot select fixtures or palettes from the buttons.

Press the Fixture button above it to return the Add/Swop buttons to fixture and palette control.

## 9.4 Manual control during a show (“busking”)

If you have not had as much programming time as you would have liked, you might need to make up some additional effects during the show. This is sometimes called “busking”, and is where the fun starts!

You can create instant variations by recalling palette values to modify your existing cues. The Diamond can fade to the palette values for added effect.

---

### ***Fading palettes over time***

- 1> *Select some fixtures which are already in use on stage.*
  - 3> *Type “2” (or any time, in seconds) on the numeric keypad.*
  - 4> *Press a Palette button to recall a colour palette.*
  - 5> *The selected fixtures will change to the new colour over a time of 2 seconds.*
- 

When a fade time is entered, you can also change the “Fixture Overlap” using softkey A. This allows you to create “roll” or “peel” effects when using a series of fixtures. With overlap=100%, all fixtures change at the same time. If overlap=50%, the second fixture will not start its fade until the first fixture is half way (50%) through fading. The order of the fixtures is set by the order in which you selected them.

When programming your palettes, group all the colour palettes in one area of the console, position palettes in another area, and so on. This helps you to find them when the show is running and the pressure is on.

You can use “Record by channel” or “Record by mask” mode when programming to set some cues to only affect position and other cues to set colours, gobos, add shapes, and so on. By combining two or more cues you can produce a much wider range of effects than if all your cues control all the attributes. However, for this to work well you need to make sure you know which attribute is going to be affected by each cue; as if you fire two “colour only” cues then nothing is going to light up.

Refer to the Reference Manual for more useful tips when running your show.

---

---

## 10. Introduction to intelligent lighting

In this chapter: A quick rundown of intelligent lighting and DMX control

- What is intelligent lighting
- DMX control
- Cautions when using DMX

This section explains the basics of DMX control and intelligent lighting.

### 10.1 Ordinary lighting

Standard lighting consists of a variety of light bulbs connected to dimmers. The lights may be anything from par cans to theatrical lanterns, and the dimmer controls the intensity of the light. A typical controller for standard lighting has a set of faders, and each fader controls the intensity of one dimmer using a low-voltage control signal of 0 to 10 volts. The standard way to link the faders to the dimmers is by using a multicore cable with one core (wire) for each dimmer channel.

### 10.2 So what is intelligent lighting?

Intelligent lighting usually contains more functions than just intensity; a typical intelligent light, often called a "fixture", can also change colour, project different patterns (called "gobos") and direct the light beam in any direction using a movable mirror or by motorised control of the light unit itself. The fixtures are called "intelligent" because they contain a small computer which controls the movement of the internal motors in response to the control signals. Some fixtures can also listen to music and produce their own light show, sometimes synchronising themselves with other intelligent fixtures. However they are actually not all that intelligent and usually need a user to make them do something interesting.

### 10.3 How do you control it?

Each function of an intelligent fixture requires its own control signal, so the user can select the colour, position, gobo etc. You can use 0 to 10 volt control signals on some fixtures, but the cable carrying the control signals again has to be a multicore with one core for each function, so each fixture might need 8 or more cores in the control cable. Some of the more complicated fixtures use 20 or more channels.

When several fixtures are used, the number of cores needed in the control cable soon becomes large. The cable also has to split at each fixture. It all gets a bit complicated.

### 10.4 The DMX control system

Fortunately, there is an easy to use system for controlling intelligent lighting and dimmers. It is called DMX-512, which stands for Digital MultipleX, and it sends up to 512 control signals down a single data cable. The cable can be simply daisy-chained from each fixture to the next. Microphone-style XLR connectors are usually used, sometimes 3-pin and sometimes 5-pin. More recently, standard computer network

(RJ45) connectors are being used.

The DMX system sends out the level for channel 1, followed by the level for channel 2, then 3, then 4 and so on, all the way up to a maximum of 512, though not all DMX systems send out all the channels. It then goes back to channel 1 again. All the units connected to the DMX receive all the channels, and you tell them which channels to respond to by setting the "base channel" or "DMX address" on each unit. The computer inside the fixture waits for the correct channels to come up, then reads in the levels for those channels.

Dimmers can also understand DMX; some dimmers can read it directly, others use a demultiplexer or "demux" to convert the DMX into the normal 0 to 10 volt analogue signals they are used to.

## 10.5 Moving light control desks

Faders are ideal for controlling dimmers. More complicated dimmer control desks have cues to record the level of all the dimmers, so you can recall a setting without having to set all the faders again during a show.

However, once you start controlling lights that move and change colour, faders become less ideal, because it is the movement rather than the end level which is important. Dedicated moving light desks such as the Diamond include many helpful functions which makes the programming of intelligent lighting much easier, such as palettes of pre-programmed colours and positions, and a shape generator to create movements.

## 10.6 A few cautions about using DMX

DMX is a robust system which normally works very well, but sometimes it can be problematic. Here are a few tips for making DMX work well.

- DMX cabling should be twisted-pair data cable. Microphone cable is not recommended because it doesn't transmit the signal as well. You will probably get away with it, but equally you might have problems.
- Always ensure the last fixture in the DMX line is terminated. This prevents data interference on the line. On some fixtures this can be done by flipping a switch, others are self-terminating, but often you will have to fit a terminating plug into the vacant DMX output on the last unit. This has a 120 ohm resistor across the DMX line.
- Don't split the DMX cable. Loop it from one unit to the next. If you have to split it, use a proper active splitter unit.
- The DMX specification says that you should not run more than 32 fixtures from one DMX line unless the fixtures are buffered or optically isolated. Either use several DMX lines (the Diamond has eight) or use a DMX repeater unit. In practice, most fixtures do not put maximum loading on the DMX line and you will probably get away with using more if you have to, but the DMX signal may be weaker than it should be which could cause erratic fixture operation.
- Try to avoid running your DMX lines near high voltage cables or neon effects. They may pick up interference which will stop the system working.

# 11. Introduction to Avolites consoles

In this chapter: How Avolites consoles relate to other moving light consoles

- Operating the console
- Manual control of lights
- Programming

If you have used intelligent lighting before, this section explains the thinking behind how Avolites consoles work and tells you what everything is called. The Diamond consoles are the biggest in the Avolites family and differ in some ways from their smaller brothers.

## 11.1 Operating the console

The console has two main modes, set using the keyswitch; these are **Operate** (which allows everything to be changed; used for programming a show, and running a show for expert users), and **Safe** (used when running a show and allows limited user override but no changes to programming).

The operation of the console is based around the two LCD screens on the bottom right of the console and the A-J **Softkeys** below them, which allow you to select the menu options on the screens. These options change depending on what the console is doing. In addition there are many buttons which allow one-button access to key functions.

One or two **VDU screens** can be connected to the console which provide many useful screens giving information to the user.

## 11.2 Controlling lights

To an Avolites console, a light is either a **Dimmer** (single intensity control channel) or a **Fixture** (Multiple control channels)

All Fixtures have a **Personality File** which tells the console how to control the fixture. You don't need to know how the fixture works, you just tell the console what you want to do with the fixture (such as change colour) and it knows which controls to change to get the effect.

You tell the console what fixtures/dimmers you have and their DMX addresses by **Patching** them. When you patch, you allocate a **Handle** to the device. The handle is one of the **Preset Faders** and **Select** buttons across the top of the console. You can allocate several dimmers to one handle if you want to group them, but only one fixture can be allocated to any one handle. The display below the fader shows you what is patched there, you can set your own legends here.

To control a fixture, you need to select the fixture you want to control by pressing the Select button of the handle. The display above the button inverts to tell you that the fixture/dimmer is selected.

Additionally you can control a dimmer, or the intensity of a fixture, using the **Fader** of the handle. If you change pages so that the fader has been controlling something else, you will need to **Match** the fader to the current dimmer level before it operates the dimmer.

Control of fixtures is done using some or all of the six **Attribute**

**Wheels.** To change the **Attributes** of the fixture(s) you've selected, just spin the wheels. The bottom three wheels always control Dimmer, Pan and Tilt. The top three wheels can be allocated to control other attributes (colour, gobo, effect etc). Select which attribute you want to control using the buttons between the two sets of wheels. The display above the wheels shows you which attributes are being controlled.

## 11.3 Programming the console

To store your looks you've created on the stage, the console provides **Cues, Chases** and **Cue Lists**. These are stored in **Playback Faders** across the front left edge of the console (you can also store them in the **Preset Faders** if you want). Many **Pages** of playbacks are available using the **Playback Page** buttons. You can set a **Legend** for each cue which is shown on the display above the fader.

When you save a playback, the console only saves settings you have changed using the wheels. Whenever you select a fixture and control it using the wheels and attribute buttons, your changes are stored in the **Programmer**. The console allows you to save just the changed attributes (Record by Channel), or it can save all attributes of every fixture you've selected (Record by Fixture). You can also choose to record only specific attributes using Record by Mask. This selective saving of attributes is often called "Tracking" on other consoles; fixture attributes remain in their last state unless you specifically change them.

The programmer records all changes in the console until you press the **Clear** button. You should press the Clear button before setting up the look for a cue, otherwise there may be all sorts of changes you don't want in the programmer, which would end up in your cue.

You can reload information from cues, chases and cue lists into the programmer, if you want to save them in another cue, using the **Include** function. This function allows you to reload either the whole cue, or selected parts of the cue into the programmer.

When you fire a playback, the console sets the fixtures to their programmed positions as soon as the fader rises above zero. The intensity of the fixtures, and any dimmers, are controlled by the fader. The intensity channels are called **HTP** (highest takes precedence) channels, because if the channel is active in more than one cue, the highest level will be output. All other channels are called **LTP** (latest takes precedence), because if the channel is active in more than one cue, the most recent change will be output.

You can program the LTP channels to fade with the fader if you want to.

Avolites consoles have a **Shape Generator** (sometimes called an effects generator on other consoles). This automatically changes attributes in a preprogrammed pattern. Fixtures can be made to move around in a circle, or to fade colours, or move in and out of focus. When a shape is applied to more than one fixture, the shape can be **Phased** so that the changes are offset in a sequence giving wave-type effects.

When you apply a shape, it goes into the programmer and is saved if you record a cue or a chase.

Avolites consoles allow you to save frequently-used positions, colours or other attributes into a **Palette** (sometimes called a Focus or Preset Focus on other consoles). Palettes are stored in the grey buttons below the preset faders and each button can be given a legend on the display.



When you want to use that setting, you simply press the button to recall the palette. If you use palettes when programming cues, the console remembers the palette rather than the actual fixture settings. This means that if you change venues or fixtures are moved, you can quickly reprogram your position palettes and all cues using those palettes will be updated. This can save you having to reprogram many cues.

Palettes can also be very useful when “busking” (modifying your programming) during a show. The console allows you to fade between palettes (**Timed Palettes**) to give smooth live changes.

Copyright Avolites Limited 2010

Copyright Avolites Limited 2010

---



---

## 12. The Diamond for Avolites experts

If you're an expert on another Avolites console, this chapter explains how the Diamond differs from the rest.

### 12.1 The Basics

The Diamond looks very similar to other Avolites consoles, but inside it is quite different. It is based around a Microsoft Windows XP PC which is built into the console. This means that:

- you need to be a bit careful turning it on and off. Always shut it down by pressing the power switch on the front. You should avoid disconnecting the power to it while it is running – an Uninterruptible Power Supply is a good thing to have.
- the VDU is a standard Windows display; you can open and close windows, reposition them, use the menus etc. A keyboard and trackball are provided in a drawer to do this. The console provides some dedicated buttons to do it as well.
- you can do anything with it that you could do with a PC such as play CDs. You can save your show to CD ROM or USB pen disks.

But remember: It's still an Avolites console, and you can mostly forget about the PC inside and get on with operating it using the faders and buttons in the way you know and love.

### 12.2 Operating it

**Softkeys and menus:** The well known LCD screen and associated softkeys are replaced by a dazzling array of smaller LCDs and buttons. But fear not, the familiar softkey structure is still there, using the two displays and 10 softkeys in the bottom right hand corner of the console.

The Up button takes you back up a menu level when the LED is lit. This is normally the same as pressing Exit. Shift+Up takes you back to the top menu level.

**Playback faders:** The playback faders are across the bottom left of the console. These are the same as on other consoles, but separate buttons are provided for Preload and for Connect (used with chases) and each fader has a display area above it to show what's in it. Memories are now called Cues. The Theatre Stack function is replaced by one or more Cue Lists. Simple chases are still called chases.

**Preset faders / handles:** An impressive number of Preset Faders are provided across the top of the console. As usual, Dimmers and Fixtures are patched here. Each preset fader has a display to show you what is patched in it. The blue swop buttons don't have lights to show you which fixtures are selected, instead the display inverts for that fixture.

**Palettes:** Are saved on the grey buttons below the Preset Faders. The display above can be programmed to remind you what is in the palette.

**Fixture Groups and Page Shortcuts** can also be stored on the grey buttons. Shortcuts allow you to set a particular playback page, palette page, fixture page and VDU desktop layout with one button press.

A rather novel feature is that in addition to storing playbacks on as the playback faders, you can also store cues, chases and cue lists in the preset faders. This allows you to have an enormous number of playbacks at your fingertips.

Fixture Attributes are controlled using six wheels rather than the normal two. This means you don't have to keep selecting different attributes as often. The bottom 3 are always Dimmer, Pan and Tilt. The attributes controlled by the top 3 are selected using the Attribute buttons below.

Locate Fixture (now just called Locate) does not move the fixture to a central position, it just turns it on in open white. If you want to move the fixture to its central position as well, hold Shift and press Locate.

Attributes have been grouped into Intensity, Pan/tilt, Colour, Gobo, Beam, Effect, Special and are referred to using the initial letters IPCGBES. The Diamond allows you to filter out or include any type of attribute when saving playbacks or palettes. Palette legends display what is contained in them using the IPCGBES letters.

A "fixture overlap" function is added which allows you to make fixtures move to their new position one after the other rather than all at the same time. This can quickly make exciting effects from simple chases or cues. Overlap can range from 100% (all fixtures move at the same time) through 50% (2<sup>nd</sup> fixture will start to move when first one is 50% through its movement) to 0% (2<sup>nd</sup> fixture will not start to move until first has completed its movement).



## **Diamond 4**

### **Reference Manual**

Copyright Avolites Limited 2010



---

**REFERENCE MANUAL CONTENTS**

---

<b>1.</b>	<b>Setting up the console</b>	<b>109</b>
1.1	Connecting up.....	109
	1.1.1 Connecting mains power .....	109
	1.1.2 Connecting DMX lines .....	109
	1.1.3 Connecting VDU monitors.....	110
	1.1.4 Other connections .....	110
1.2	Configuring the console .....	111
	1.2.1 Turning it on and off.....	111
	1.2.2 The Tools menu .....	111
	1.2.3 The VDU desktop .....	112
	1.2.4 Visualiser .....	114
	1.2.5 The Diamond 4 Simulator and Desktop .....	115
1.3	Guide to the console .....	116
	1.3.1 The different versions of console .....	116
	1.3.2 Main features of the Diamond 4 .....	116
1.4	Loading and saving shows .....	121
	1.4.1 Autosave.....	121
	1.4.2 Manual save and load .....	121
	1.4.3 Saving shows for pre-Titan consoles .....	122
1.5	Backing up the show to CD-ROM or USB drive .....	122
	1.5.1 Backup current show to USB pen drive.....	122
	1.5.2 Backup existing show files to USB pen drive .....	122
1.6	Clearing the console.....	123
1.7	Using Presets on the Elite Version .....	123
1.8	Console Troubleshooting.....	123
<b>2.</b>	<b>Patching</b>	<b>127</b>
2.1	Create .....	127
	2.1.1 Preset faders (handles) .....	127
	2.1.2 Patching dimmers .....	128
	2.1.3 Patching moving light fixtures.....	128
	2.1.4 Checking the patching .....	129
2.2	Edit .....	130
	2.2.1 Changing the DMX address of a fixture .....	130
	2.2.2 Parking fixtures.....	131
	2.2.3 Setting legends.....	131
	2.2.4 Updating personalities of patched fixtures .....	131
2.3	Copy.....	132
	2.3.1 Copying a patched fixture .....	132
2.4	Delete.....	132
	2.4.1 Deleting a patched fixture .....	132
	2.4.2 Deleting an individual DMX channel .....	132
2.5	Moving.....	133
	2.5.1 Moving a fixture to a different handle .....	133
2.6	Advanced options .....	133
	2.6.1 Set Fixture User Number .....	133
	2.6.2 Swap pan and tilt.....	133
	2.6.3 Invert channels.....	134
	2.6.4 Setting DMX outputs.....	134
	2.6.5 Save Patch List .....	135
2.7	Fixture Exchange.....	135
<b>3.</b>	<b>Controlling dimmers and fixtures</b>	<b>137</b>
3.1	Create .....	137
	3.1.1 Selecting fixtures and dimmers for control.....	137
	3.1.2 Using presets on the Elite version of the console .....	138
	3.1.3 Changing attributes using the wheels.....	138
	3.1.4 Attribute groups - IPCGBES .....	139
	3.1.5 Selecting named attributes (Shift+@ button).....	140
	3.1.6 Other attribute control functions (@ button) .....	140
	3.1.7 Entering attribute values numerically.....	141
	3.1.8 Using groups .....	141
	3.1.9 Stepping through selected fixtures one at a time.....	141
	3.1.10 Highlighting the selected fixture .....	142
	3.1.11 Select odd or even fixtures out of a selection range .....	142

3.1.12	Inverting fixture selection.....	142
3.1.13	Selecting fixtures which are using a palette (Sel If).....	142
3.1.14	The Align and Flip functions.....	143
3.1.15	Selecting dimmers and setting intensity levels on keypad.....	143
3.1.16	Selecting fixtures from the keypad.....	144
3.1.17	Fan mode.....	145
3.2	Advanced options.....	145
3.2.1	The ML menu and Tracking.....	145
3.2.2	Training the console for Tracking mode.....	146
<b>4.</b>	<b>Palettes</b>	<b>147</b>
4.1	Create.....	147
4.1.1	Palette values stored as a reference.....	147
4.1.2	Shared and Normal palettes.....	147
4.1.3	Which attributes are stored in palettes.....	147
4.1.4	Storing a palette.....	148
4.2	Playback.....	148
4.2.1	Recalling a palette value.....	148
4.2.2	Palette pages.....	149
4.3	Edit.....	149
4.3.1	Editing palettes.....	149
4.3.2	Setting legends for palettes.....	149
4.4	Delete.....	150
4.4.1	Deleting palettes.....	150
4.5	Moving.....	150
4.5.1	Moving palettes.....	150
4.6	Timing.....	150
4.6.1	Fading a palette.....	150
4.6.2	Storing times and overlap in palettes.....	150
<b>5.</b>	<b>Shapes</b>	<b>153</b>
5.1	Playback.....	153
5.1.1	Creating a shape.....	153
5.1.2	Changing size and speed of a shape.....	154
5.1.3	Changing the phase of a shape across multiple fixtures.....	155
5.1.4	Changing the initial offset phase of a shape.....	156
5.2	Edit.....	156
5.2.1	Editing shapes which are running.....	156
5.2.2	Changing the order of fixtures in the shape.....	157
5.2.3	Reversing a shape.....	157
5.3	Delete.....	157
5.3.1	Deleting shapes.....	157
5.4	Advanced options.....	157
5.4.1	Shape fade mode.....	157
5.4.2	Shape LTP rules.....	158
<b>6.</b>	<b>Cues</b>	<b>159</b>
6.1	Create.....	159
6.1.1	How the Diamond works when programming.....	159
6.1.2	Creating a cue.....	161
6.1.3	Using shapes in cues.....	161
6.2	Playback.....	162
6.2.1	HTP and LTP.....	162
6.2.2	Playing back a cue.....	162
6.2.3	Changing playback pages.....	163
6.3	Edit.....	164
6.3.1	Editing a cue.....	164
6.3.2	The Include function.....	164
6.3.3	Removing attributes from cues using "Off".....	165
6.3.4	Reinstating attributes to cues using "On".....	165
6.3.5	Other "Off" functions.....	166
6.4	Copy.....	166
6.4.1	Copying a cue.....	166
6.5	Delete.....	167
6.5.1	Deleting a cue.....	167
6.6	Moving.....	167
6.6.1	Moving a cue.....	167



6.7	Timing .....	167
	6.7.1 Setting fade times and Overlap for a cue.....	167
	6.7.2 Setting attribute fade times for a cue.....	170
6.8	Advanced options .....	170
	6.8.1 Playback Options.....	170
	6.8.2 Recording in Blind mode .....	171
	6.8.3 Firing a cue by MIDI .....	171
<b>7.</b>	<b>Chases</b> .....	<b>173</b>
7.1	Create .....	173
	7.1.1 Programming a chase .....	173
7.2	Playback .....	174
	7.2.1 Playing back a chase .....	174
	7.2.2 Connecting a chase to a Controller .....	175
	7.2.3 Setting speed and crossfade for a Chase .....	175
	7.2.4 Manually controlling the steps of a chase.....	176
	7.2.5 Viewing Chase steps.....	177
7.3	Edit .....	177
	7.3.1 Opening a chase for editing .....	177
	7.3.2 Editing a chase using Unfold .....	177
	7.3.3 Editing a chase which is running.....	178
7.4	Copy.....	178
	7.4.1 Copying chases.....	178
	7.4.2 Copying single cues from one chase or cue list to another .....	179
7.5	Delete.....	179
	7.5.1 Deleting a chase .....	179
	7.5.2 Deleting a step from a chase or cue list.....	179
7.6	Moving.....	179
	7.6.1 Moving a chase.....	179
7.7	Timing .....	180
	7.7.1 Global timings for chases .....	180
	7.7.2 Individual cue times in chases .....	181
	7.7.3 Setting fixture order for Overlap functions.....	182
	7.7.4 Viewing timing information.....	182
7.8	Advanced options .....	183
	7.8.1 Playback Options.....	183
	7.8.2 Using MIDI with chases.....	184
<b>8.</b>	<b>Cue Lists</b> .....	<b>185</b>
8.1	Create .....	185
	8.1.1 Programming a cue-list .....	185
	8.1.2 Programming a cue-list from existing cues .....	186
8.2	Playback .....	187
	8.2.1 Connecting a cue list to a Controller .....	187
	8.2.2 Running a cue list.....	187
	8.2.3 Viewing Cue List steps on the VDU .....	188
8.3	Edit .....	188
	8.3.1 Opening a cue list for editing .....	188
	8.3.2 Editing a cue list using Unfold .....	188
	8.3.3 Editing a cue list which is running.....	189
8.4	Copy.....	190
	8.4.1 Copying cue lists.....	190
8.5	Delete.....	190
	8.5.1 Deleting a cue list .....	190
	8.5.2 Deleting a step from a cue list .....	190
8.6	Moving.....	191
	8.6.1 Moving a cue list.....	191
8.7	Timing .....	191
	8.7.1 Time and fade options for Cue Lists .....	191
	8.7.2 Individual attribute fade times .....	192
	8.7.3 Cue and fixture overlap.....	192
	8.7.4 Viewing timing information .....	193
8.8	Advanced options .....	193
	8.8.1 Playback Options.....	193
	8.8.2 Using MIDI with cue lists.....	195
<b>9.</b>	<b>Running the show</b> .....	<b>197</b>

9.1	Playback .....	197
	9.1.1 Back up the show.....	197
	9.1.2 Operating modes .....	197
	9.1.3 Master faders .....	197
	9.1.4 Flash and swop buttons .....	198
	9.1.5 Manual control during a show ("busking") .....	198
	9.1.6 Page shortcuts.....	199
9.2	View Menu.....	200
9.3	Move .....	201
	9.3.1 Using the Move function.....	201
	9.3.2 Using the Move function for Shortcuts.....	201
	9.3.3 Using the Move function to swop pages.....	202
<b>10.</b>	<b>Timecode playback</b> .....	<b>203</b>
10.1	Create .....	203
	10.1.1 Enabling a cue list for timecode operation.....	203
	10.1.2 Assigning timecodes to cues .....	203
10.2	Playback .....	204
	10.2.1 Running a timecode cue list .....	204
	10.2.2 Timecode viewer .....	205
10.3	Edit .....	205
	10.3.1 Changing timecode for a cue.....	205
<b>11.</b>	<b>User Settings and other options</b> .....	<b>207</b>
11.1	Tools menu.....	207
	11.1.1 Virtual Panel.....	207
	11.1.2 Visualiser .....	207
	11.1.3 User settings .....	207
	11.1.4 Factory settings .....	214
	11.1.5 Exchange fixture .....	214
	11.1.6 Setup DMX outputs.....	214
	11.1.7 Hotkeys .....	215
11.2	Utilities Menu .....	215
	11.2.1 Set User Numbers .....	215
	11.2.2 Lock Playback .....	216
	11.2.3 Set Masters .....	216
	11.2.4 Record shortcut.....	216
	11.2.5 2 Preset Mode.....	216
	11.2.6 Enable hardware check .....	217
11.3	Tracking Backup.....	217
11.4	Dimmer & fade curves.....	218
11.5	Upgrading the software .....	220
<b>12.</b>	<b>Working with Fixture Personalities</b> .....	<b>222</b>
	12.1.1 Downloading fixture personalities from Avolites.....	222
	12.1.2 Updating the personality cache on the console .....	223
	12.1.3 Requesting a new fixture personality.....	223
	12.1.4 Reporting a personality bug to Avolites .....	223
	12.1.5 In an emergency.....	223
<b>13.</b>	<b>The Diamond 4 Pilot</b> .....	<b>226</b>
	13.1.1 Connecting Up .....	226
	13.1.2 Layout .....	226
	13.1.3 Operating.....	227
<b>14.</b>	<b>Networking</b> .....	<b>228</b>
14.1	Setting the Diamond's IP address .....	228
	14.1.1 Setting IP address from the setup menu.....	228
14.2	Setting up DMX outputs.....	229
	14.2.1 Setup DMX outputs screen.....	229
14.3	Connecting to a simulator with ACDI .....	230
	14.3.1 ACDI .....	230
14.4	ArtNet.....	231
	14.4.1 A simple ArtNet system .....	231
	14.4.2 Setting up an ArtNet system.....	232
	14.4.3 ArtNet IP Address Warning .....	234
	14.4.4 Additional ArtNet Resources.....	234
14.5	eDmx .....	234

14.5.1	Setting up eDmx with Diamond 4 .....	235
14.6	EzDmx .....	236
14.7	Module Setup .....	237
14.7.1	Installing additional Modules .....	237
14.8	AvoTalk .....	237
14.8.1	Example AvoTalk setup .....	238
14.9	All about IP addressing .....	239
14.9.1	Setting your IP address .....	239
14.9.2	Subnet Masks .....	241
14.9.3	Choosing an IP address and Subnet Mask .....	241
14.9.4	Automatically assigning IP addresses (DHCP) .....	242
14.9.5	Private IP address ranges .....	242
14.9.6	Ping .....	242
14.10	Repairing a Network Connection .....	242
<b>15.</b>	<b>Glossary of terms</b>	<b>244</b>

Copyright Avolites Limited 2010

# 1. Setting up the console

*This chapter contains: Connecting mains power, DMX lines, VDUs; configuring the console and the various VDU windows; guide to where everything is on the console; loading and saving shows.*

## 1.1 Connecting up

### 1.1.1 Connecting mains power

**Important!** Before connecting the mains power to the Diamond you must check if the Diamond has a voltage selector switch next to the mains socket; if it does, make sure it is set to match your mains supply. It can be set to 120V or 220V.

If the Diamond does not have a voltage selector switch you can safely connect it to any voltage from 80 to 260V.

If you connect mains power with the switch set incorrectly, you will probably blow up the power supply unit. If this happens you will need to shamefacedly return the console to Avolites for repair.

We recommend that you run the console from a UPS (uninterruptible power supply) which are widely available for desktop computers. If the console unexpectedly loses power, you can lose data (up to the last Autosave) and the console may want to check its disks on startup which can cause delays.

### 1.1.2 Connecting DMX lines

The Diamond communicates with lighting fixtures using the DMX system. It can produce 12 universes of DMX (each 512 control channels). It has 8 physical DMX lines for direct connection to fixtures and dimmers, and can also send DMX over Ethernet and wireless Ethernet systems to allow connection to remote DMX Ethernet nodes and to the Avolites Console DMX Interface (ACDI) system which is used to connect visualiser applications.

When you patch a dimmer or fixture you tell the Diamond which of the 12 DMX lines it is on. The lines are identified by the letters A,B,C,D,E,F,G,H,I,J,K,L. Each of these lines can be configured to come out of one or more of the standard DMX outputs on the back of the console (see section 2.6.4 on page 134), or over an Ethernet protocol (see section 14 on page 228.)

The 8 standard DMX outputs come out of the 5 pin XLR sockets on the back of the console. They are wired like this:

Pin 1	Earth
Pin 2	Data -
Pin 3	Data +
Pin 4	Not used
Pin 5	Not used

Each DMX line should pass through all the fixtures to be connected on that line one after the other and have a DMX terminator fitted at the end (120 ohm resistor between pins 2 and 3). You should not split the DMX lines using passive splitters as this can mess up the data.

### 1.1.3 Connecting VDU monitors

You need at least one VGA monitor on the Diamond, which is plugged into the VGA port on the rear of the console. You can connect a second monitor to the DVI port next to it; if your monitor doesn't have a DVI input, an adaptor is supplied to convert the output to VGA.

The second monitor can be useful if you need to see lots of windows at the same time, or if you want to keep Visualiser full screen all the time.

The first time you connect displays, you need to tell the console the resolution you want to use (such as 1024 x 768) and whether you have one or two displays connected. You can reconfigure this at any time if you change display type.

- 1> Press Setup button (bottom right).
- 2> Press G [Set VDU Options].
- 3> Select A,B,C,D or E for preset modes or press J to open the standard Windows desktop setup dialog.

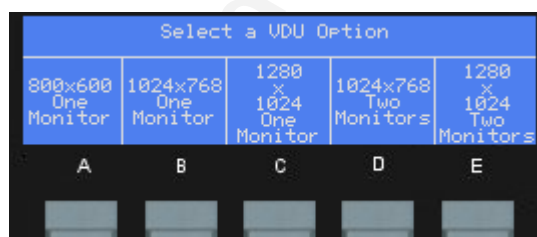

- If the VDU appears garbled when the console starts up, this is probably due to a different monitor being used which does not support the output resolution set on the console. Press Setup, G then A. This will set the output to the lowest resolution which should work on all monitors.

### 1.1.4 Other connections

You can connect an external keyboard and mouse to the console if for some reason you don't like the trackball and keyboard in the drawer on the front.

The console provides MIDI connections. The MIDI In is used for MIDI timecode, and to trigger cues. The MIDI out can be enabled to output a MIDI note when a cue is fired on the Diamond to trigger an external device.

You can connect the console to a LAN (local area network) using the RJ45 socket on the rear. This allows you to back up the console to another machine, or to link to a DMX-over-ethernet system.

Three 3-pin XLR sockets for desk lamps are provided on the rear edge of the console. Suitable lamps are available from Avolites. The lamps are 12 volt, wired from pins 1 and 2 of the XLR. The brightness of the lamps can be adjusted using the bottom control knob near the keyswitch.

## 1.2 Configuring the console

The Diamond is based around a Microsoft Windows XP Embedded PC which is built into the console. This means that the VDU uses a standard Windows interface; you can open and close windows, reposition them, use the menus etc. A keyboard and trackball is provided in a drawer to do this. Some standard Windows functions are also directly available from buttons on the console.

For those who hate PC's, you can mostly forget about the PC inside and get on with operating it using the faders and buttons like any other lighting console.

### 1.2.1 Turning it on and off

Ensure the power switch on the power supply (rear of the console) is turned on (this switch can be left on permanently).

Press and release the power switch on the front left of the console to start it up (on a few consoles this switch is fitted at the back). The console displays should light up and the VDU should show a boot screen. The console takes about 20-50 seconds to start up fully. If the console appears to freeze on startup with blank displays, it is probably doing a disk check due to an irregular power-down; in this situation you must leave the console to complete the check, after which it will power up normally, but the check may take several minutes.

To turn the console off, press and release the power switch on the front of the console. The console will perform a controlled shutdown which takes about 15-30 seconds. Do not disconnect the power from the console while it is shutting down. You should also avoid disconnecting the power to the console while it is running as any changes to your show (since the last Autosave) will be lost and also it may upset the operating system which will delay the next startup.

### 1.2.2 The Tools menu

The Tools menu on the top left corner of the screen allows you to access Windows functions such as File explorer (to move files around), Control Panel (to setup hardware), and to stop or restart the D4 application or run other programs.

**About** gives you information about the software version.

**Help** shows you the online manual.

**Control Panel** opens a sub-menu allowing changes to monitor settings and to the USB expert console which links the front panel controls to the system. The "More..." option opens Windows Control Panel allowing you to change the operating system configuration.

**Folders** opens the file explorer. You might need this when backing up show files or when updating the operating software.

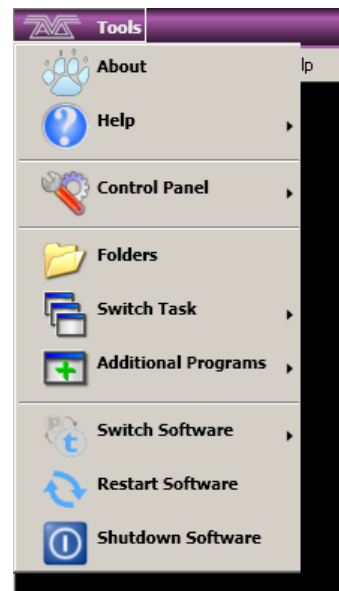

**Switch Task** allows you to bring programs in front of the D4 windows and move them between the VDU screens. Click on the Switch Screen icon to swap the program between the VDUs. Click the Centre icon to

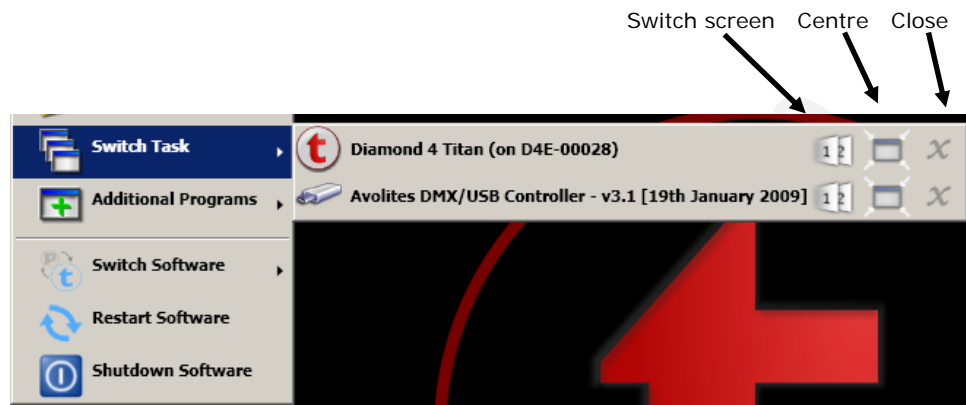

centre the window on the screen. Click Close to close the program.

**Additional Programs** allows you to run some diagnostic programs which might help Avolites Support find problems you're having.

**Switch Software** switches the console between Vision and Elite modes.

**Restart** and **Shutdown Software** restarts and closes the D4 software. You would normally only use these when upgrading the software.

### 1.2.3 The VDU desktop

The desktop is your view into what the Diamond is doing. It can display windows showing Intensity output, Stage output, DMX output, and you can also turn on or off views of the command line and status bar.

Use the View menu to show or hide the various information screens available.

The **Virtual Panel** brings up an on screen version of the console front panel, this allows the operator to perform on screen all of the functions access from the panel.

The **Intensity view** shows you the intensity output of all patched fixtures. The brightness of the graphic shows the intensity of the fixture (White=Full intensity, dark grey=Off). The intensity is also shown as a percentage. By right clicking on this screen you can also enable or disable display of the Legend, control group, DMX address and dimmer curve of each fixture.

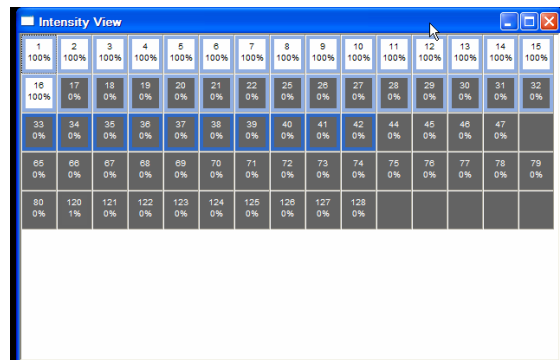

Fixtures are highlighted in light blue if they are in the programmer (if



their output has been changed by the user). They are highlighted in dark blue if they are currently selected (they are in the editor and the programmer).

Name	Handle	IPCGBES	Iris	Colour	Frost	Dimmer	Pan	Tilt	Zoom	Focus	Prism	Prism Rotation	Gobo 1	Gobo 2	Gobo 2 Rot	Cyan	Magenta	Yellow
Stage Scan 1	1		Open 0%	Open	Open	100.0 %	50.00%	50.00%	24.9°	Focus 50 %	Open	Index 0°	Open	Open	Index 0°	0.0%	0.0%	0.0%
Stage Scan 2	2		Open 0%	Open	Open	100.0 %	50.00%	50.00%	24.9°	Focus 50 %	Open	Index 0°	Open	Open	Index 0°	0.0%	0.0%	0.0%
Stage Scan 3	3		Open 0%	Open	Open	100.0 %	50.00%	50.00%	24.9°	Focus 50 %	Open	Index 0°	Open	Open	Index 0°	0.0%	0.0%	0.0%
Stage Scan 4	4		Open 0%	Open	Open	100.0 %	50.00%	50.00%	24.9°	Focus 50 %	Open	Index 0°	Open	Open	Index 0°	0.0%	0.0%	0.0%
Stage Scan 5	5	P	Open 0%	Open	Open	100.0 %	53.99%	50.00%	24.9°	Focus 50 %	Open	Index 0°	Open	Open	Index 0°	0.0%	0.0%	0.0%
Stage Scan 6	6	P	Open 0%	Open	Open	100.0 %	53.99%	50.00%	24.9°	Focus 50 %	Open	Index 0°	Open	Open	Index 0°	0.0%	0.0%	0.0%
Stage Scan 7	7	P	Open 0%	Open	Open	100.0 %	53.99%	50.00%	24.9°	Focus 50 %	Open	Index 0°	Open	Open	Index 0°	0.0%	0.0%	0.0%
Stage Scan 8	8	P	Open 0%	Open	Open	100.0 %	53.99%	50.00%	24.9°	Focus 50 %	Open	Index 0°	Open	Open	Index 0°	0.0%	0.0%	0.0%
Stage Scan 9	9		Open 0%	Open	Open	100.0 %	50.00%	50.00%	24.9°	Focus 50 %	Open	Index 0°	Open	Open	Index 0°	0.0%	0.0%	0.0%
Stage Scan 10	10		Open 0%	Open	Open	100.0 %	50.00%	50.00%	24.9°	Focus 50 %	Open	Index 0°	Open	Open	Index 0°	0.0%	0.0%	0.0%
Stage Scan 11	11		Open 0%	Open	Open	100.0 %	50.00%	50.00%	24.9°	Focus 50 %	Open	Index 0°	Open	Open	Index 0°	0.0%	0.0%	0.0%
Stage Scan 12	12		Open 0%	Open	Open	100.0 %	50.00%	50.00%	24.9°	Focus 50 %	Open	Index 0°	Open	Open	Index 0°	0.0%	0.0%	0.0%

The **Stage view** shows you the detail of all fixtures patched on the console. You select the fixture type to view using the tabs across the bottom of the screen.

Again the light blue colour shows fixtures which are in the programmer and dark blue shows fixtures selected to the editor. Any changed attributes are shown using Cyan.

The window shows the output value of each attribute of each fixture. If the fixtures are under control of a playback or palette, the display shows what last controlled each attribute.

You can sort the fixtures on the screen by any of the columns; just click on the column header. Click again to reverse the sort order. You can change the order of the columns by dragging them to a new position. By right clicking on this screen you can enable or disable highlighting of changes, and display of playback/palette control of attributes.

The **Show Library** view allows the operator to view any aspect of the recorded show (playbacks), and edit times on screen in a spreadsheet like manner.

The **Wheels** view shows the parameters available on each wheel. A colour picker view is shown if the wheel parameters are colours.

The **DMX view** shows the output value of each DMX channel, and which fixture is patched to it.

As with the stage view, you can sort the list on any of the columns by clicking on the column header, or reorder the columns by dragging.

The red values indicate values which are currently changing.

The VDU screen also has a **Command Line** window, which shows the commands that the console is currently processing and provides useful feedback, and a status bar which shows

Offset	Line	Addr	Handle	Fixture	Control	Output
1	A	1	120	GoldenS	Colour	0
2	A	2	120	GoldenS	Effect	4
3	A	3	120	GoldenS	Dimmer	24
4	A	4	120	GoldenS	Pan	128
5	A	5	120	GoldenS	Tilt	127
6	A	6	1	Stage	Tilt	127
7	A	7	1	Stage	Zoom	21
8	A	8	1	Stage	Focus	127
9	A	9	1	Stage	Prism	28
10	A	10	1	Stage	Prism R	0
11	A	11	1	Stage	Gobo 1	24
12	A	12	1	Stage	Gobo 2	28
13	A	13	1	Stage	Gobo 2	0
14	A	14	1	Stage	Cyan	266
15	A	15	1	Stage	Magent	265
16	A	16	1	Stage	Yellow	265
17	A	17	2	Stage	Iris	0
18	A	18	2	Stage	Colour	4
19	A	19	2	Stage	Frost	24
20	A	20	2	Stage	Dimmer	128
21	A	21	2	Stage	Pan	127
22	A	22	2	Stage	Tilt	127
23	A	23	2	Stage	Zoom	21
24	A	24	2	Stage	Focus	127
25	A	25	2	Stage	Prism	28
26	A	26	2	Stage	Prism R	0
27	A	27	2	Stage	Gobo 1	24
28	A	28	2	Stage	Gobo 2	28
29	A	29	2	Stage	Gobo 2	0

what the on-board menu displays are currently showing.

You can select which windows are visible using the grey View button below softkey H. This will give a list of windows which can be opened by selecting the appropriate softkey.

If you are happier using the trackball to access the menu in the normal Windowsy way, you can of course do it that way.

You can rearrange the windows on screen as you like using the trackball. You can save several different versions of the desktop layout using Shortcut buttons (see section 9.1.6 on page 199). If you move the DMX view window to the edge of the screen it will "dock" there.

The operating options of the console are set from the VDU screen Tools menu, see section 11.1.3 on page 207 for details.

### 1.2.4 Visualiser

The Diamond 4 runs Avolites Visualiser internally. This allows you to view the output of the console if you can't use the real lights, enabling you to make changes to your show at home or in your hotel. You can show or hide (minimise) Visualiser using G [Press to show/hide Vis] on the top level menu. You need to select the "Simulator" option on Visualiser to make it read the output of the Diamond.

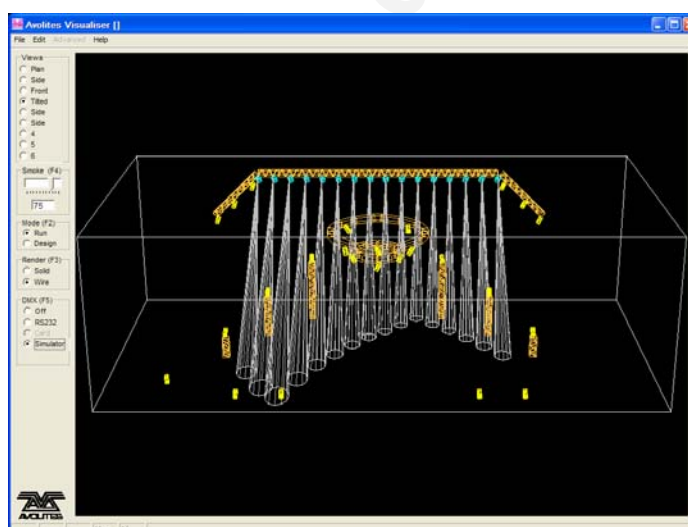

The operation of Visualiser is not covered in this manual, please refer to the Visualiser manual.

If you have two VDU screens connected, you can keep Visualiser permanently visible using the User Settings (see section 11.1.3 on page 207). If you only have one screen, the Diamond application may keep popping up over the top of Visualiser, and you have to click on it on the taskbar to get it back.

#### Auto Patch

The Auto Patch function automatically creates a Visualiser rig from your D4 show. To start up Vis with a pre-patched theatre press G [Press To Show Vis] on the top level Operate menu. Visualiser will open with a representation of your patch.

You will see the fixtures laid out on screen as they are on the console, so any spaces between fixtures will be preserved and fixtures patched to the top row of presets will be shown above fixtures patched to the bottom row of presets.

If you have patched across multiple pages, each page of fixtures will be separated by a truss to make it easy to identify them. The Visualiser will start in run mode, with the simulator tab selected so you can start

controlling lights immediately.

Multiple dimmers patched to one handle will appear as a single fixture in Visualiser.

If you wish to open Visualiser normally, Press the grey View button, then B [Visualiser].

### Fixture Select

When a Visualiser rig has been created with Auto Patch, the Visualiser will indicate any fixtures that are currently in the programmer by highlighting them in blue.

## 1.2.5 The Diamond 4 Simulator and Desktop

A console simulator is available as a free download from the Avolites website, allowing you to create or edit shows on a normal PC if you don't have access to the real console. (PC must be running Windows XP). The simulator runs identical software to the real console (including Visualiser), using a "virtual panel" on the screen to allow you to operate the controls.

You use the mouse to click buttons and move the faders and wheels. To save space on the screen, the blue select and grey palette buttons of the preset faders are not shown, instead you just click on the legend display below the fader. If you need to hold a button on the virtual panel and press another button, use the right mouse button to click the first button.

Shows saved on the simulator can be loaded directly into the real console.

The "virtual panel" displayed on the screen is split into individual sections which can be moved around independently. This avoids a lot of scrolling around to find the section you want.

Using Avolites EzDMX device, the simulator can become a fully functional console, called the "D4 Desktop", and can be used to control a lighting rig as if it was a real Diamond 4. It will also output various flavours of DMX over the PC's ethernet port, when fitted with the D4 USB dongle (available from Avolites). Additionally the D4 Pilot control device may be attached to give some real sliders and other controls for programming (see section 13).



## 1.3 Guide to the console

### 1.3.1 The different versions of console

There are three versions of the Diamond 4 console: The Classic, Vision and Elite.

The Classic and Vision versions are the same to operate, having 128 preset handles (all with faders) and 28 playback faders. They differ slightly in mechanical assembly.

The Elite console has 96 preset handles, of which the top 48 do not have faders. The faders from the bottom 48 handles can be allocated to control either the bottom or top set of handles. It has 14 playback faders.

### 1.3.2 Main features of the Diamond 4

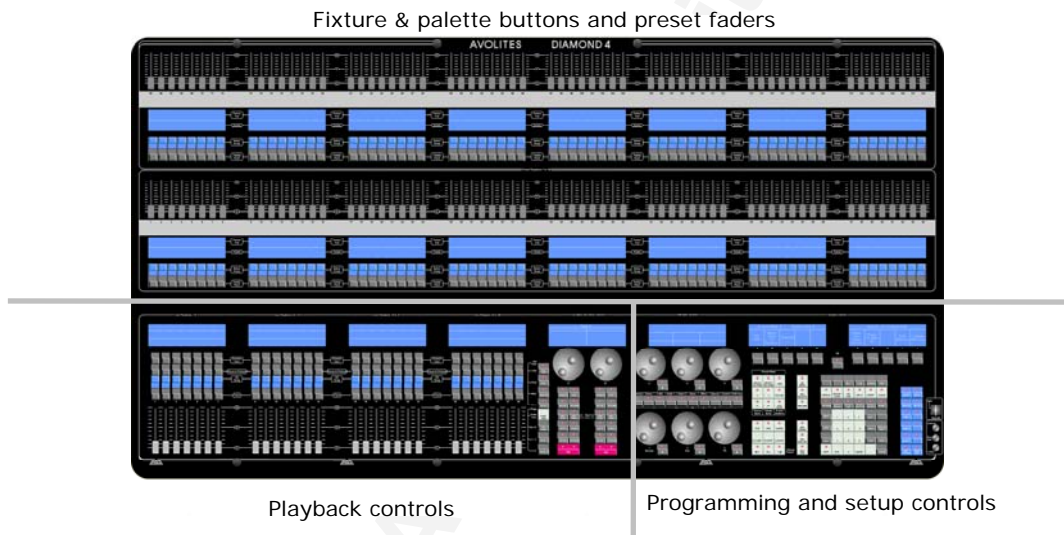

The console has three main areas.

The top half of the console has faders, buttons and displays for fixtures and palettes. You can also store cues, chases and cue lists in these faders and buttons.

The bottom left of the console has the playback buttons and faders which are normally used for storing cues, chases and cue lists.

The bottom right of the console has all the programming and setup controls and displays.

## Programming and setup controls

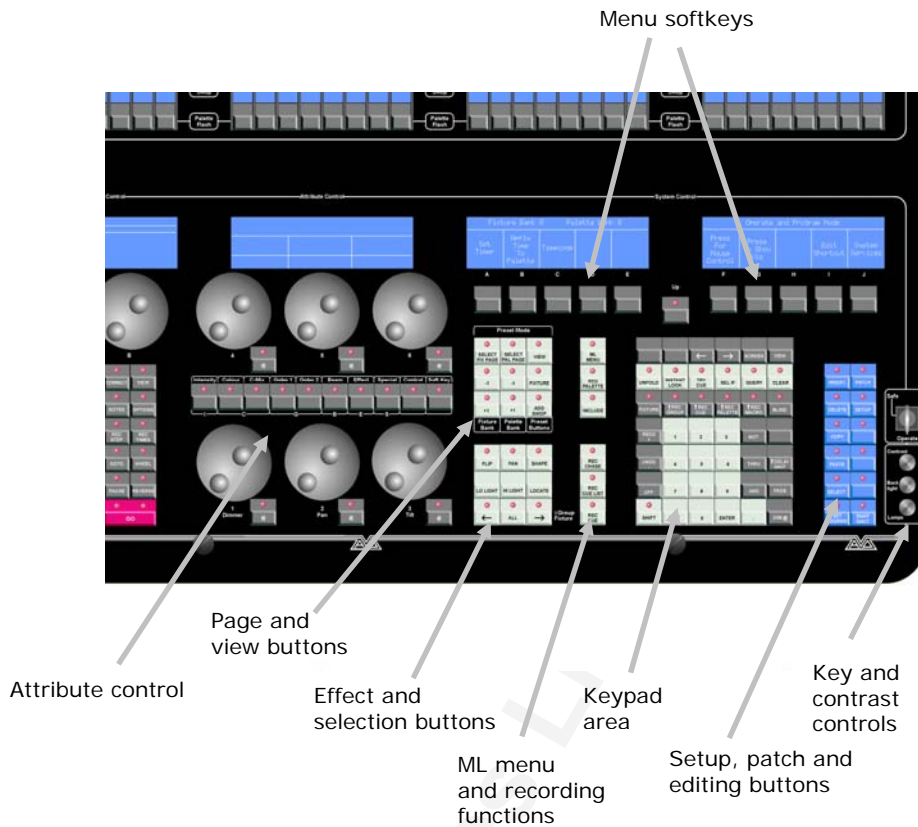

**Menu softkeys:** These two displays and 10 buttons are the nerve centre of the console, allowing you to select a wide range of menu options. The Up button takes you back to the previous menu level. Shift+Up takes you back to the top menu level.

**Attribute control:** This is where you set the position, colour, gobo, dimmer intensity and other attributes of fixtures when you are programming the console.

**Page and view buttons:** Page buttons allow you to swop the controls to another page of fixtures or cues. View allows you to show various screens on the displays.

**Effect and selection buttons:** These buttons provide useful functions when programming moving lights, and also allow you to step through selected fixtures one at a time.

**ML Menu and recording functions:** These buttons give access to the Moving Light menu and allow you to record chases, cues and cue lists

**Keypad area:** This area contains the numeric keypad for number entry, cursor buttons, the shift button (which accesses any functions with a small up-arrow next to them), and buttons to record groups, palettes, cues and macros.

**Setup, patch and editing buttons:** These buttons allow you to set up the console and also to edit programming.

**Key and contrast controls:** The key allows you to switch the console to Safe mode which is a playback-only mode preventing changes being made. Starting from the top, the knobs control LCD contrast, LCD back light brightness and desk lamp brightness.



## Cue Playback faders and buttons

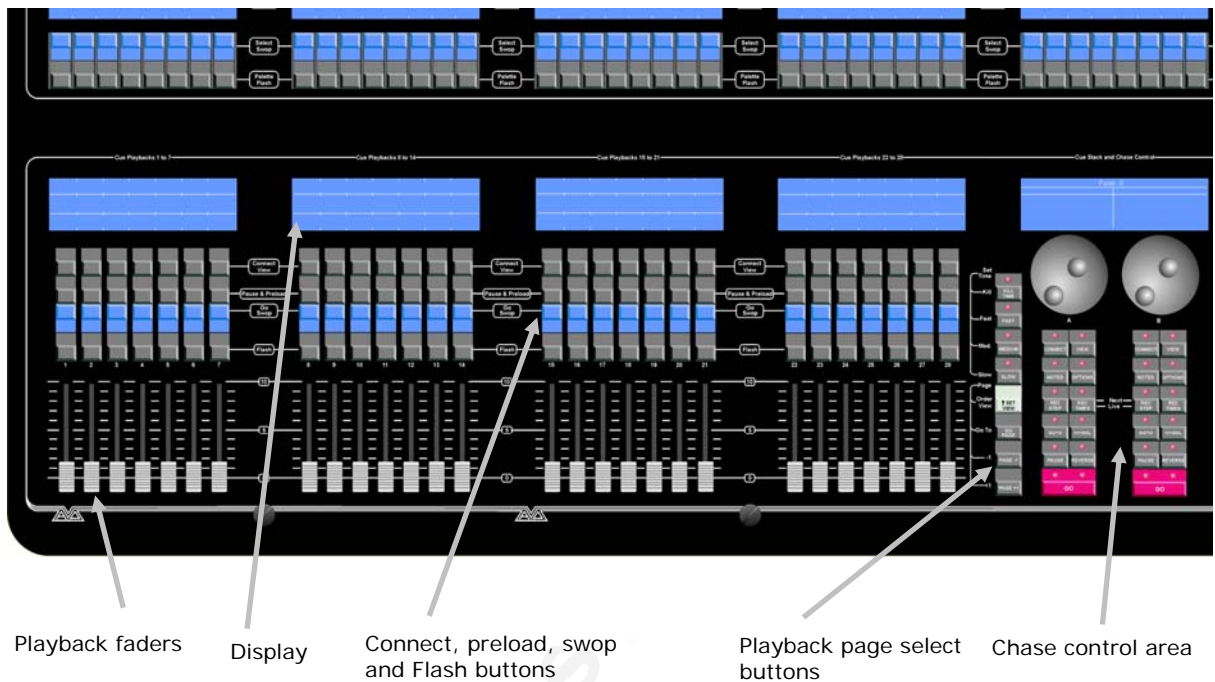

This area is where you store and playback cues, chases and cue lists. You can also store playbacks on the preset faders.

**Playback faders:** Allow you to fade the playback in and out.

**Displays:** Show legends for the playbacks, which you can set to help you remember what's in them.

**Connect, preload, swop and flash buttons:** The Connect button allows you to connect a cue list or chase to a chase controller so you can control playback and set timing and other options. The Preload button will position all moving light fixtures to the programmed positions in the cue so that when you fade up the fader, the lights will already be in their proper positions. The Swop button is used to select the playback when programming and can be used to "solo" the playback and the flash button is like moving the fader to full.

**Playback page select buttons:** The Vision console has 28 playbacks per page, the Elite console has 14. You can select a different page of playbacks using these page select buttons.

**Chase control area:** Allows you to start and stop chases and cue lists and control the speed, fade, direction and set other options

## Preset faders and buttons

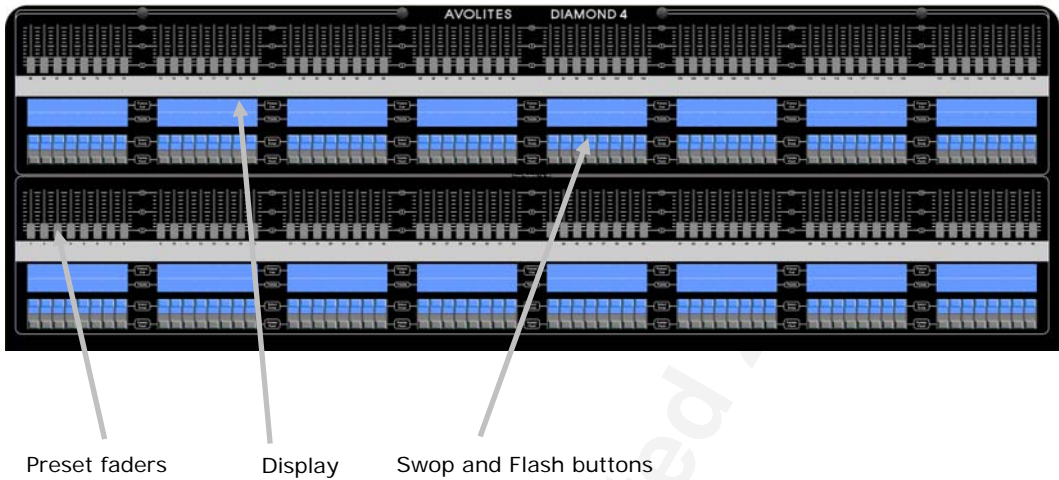

This area is where dimmers and fixtures are controlled, and also where palettes, groups, page shortcuts and playbacks may be stored.

**Preset faders:** Control the intensity of the dimmer or fixture. If a playback is stored on the preset the fader is used to fire the playback and set its level.

**Display:** The top section shows the name/type of the fixture patched to that fader. The bottom section shows which palette, group or shortcut is stored in each position.

**Select/Swop and Palette/Flash buttons:** The blue Select button selects the fixture for control. The grey Palette button recalls palettes, groups or page shortcuts. The Select and Palette buttons may instead be used to flash and swop the patched fixture (or the playback stored in the preset) if the Add/Swop button below Softkey B is pressed.

### Other controls and connections

The rear of the console has all the connections. The front of the console has a CD or DVD drive, floppy drive and a keyboard/trackball in a drawer.

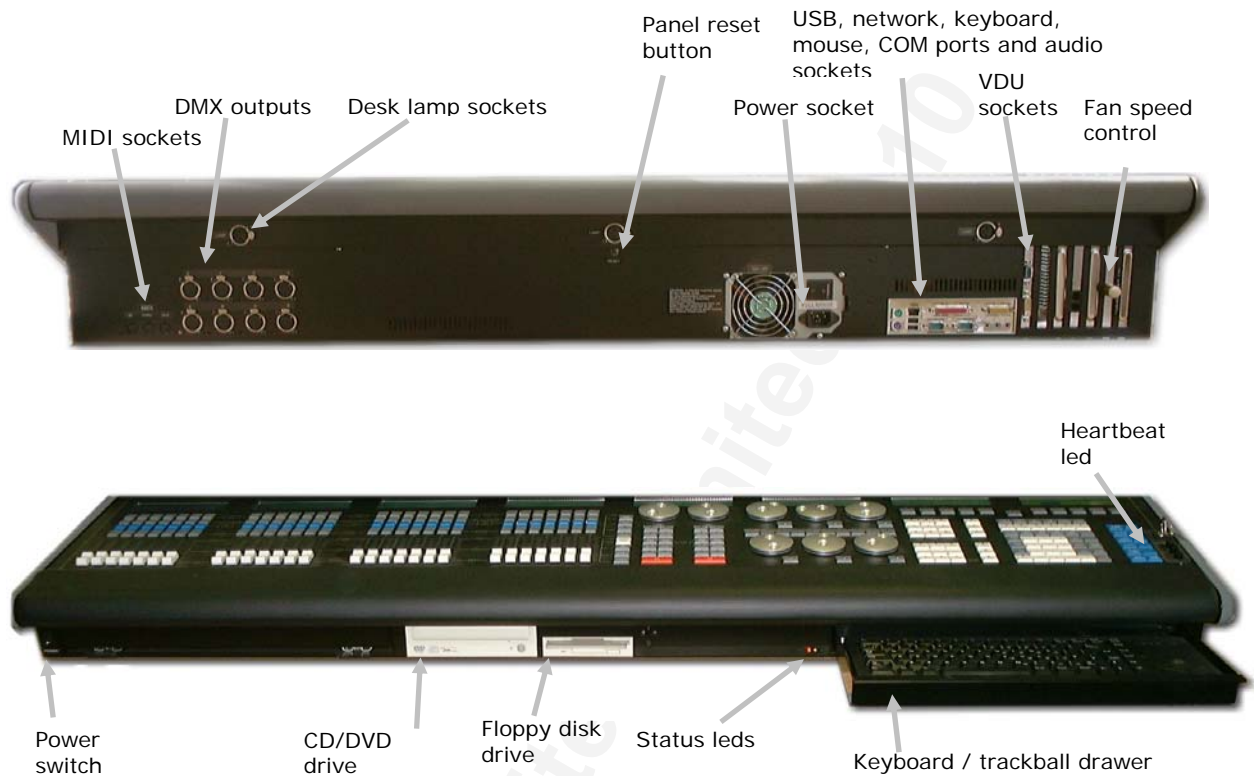

The status LEDs are Red for power on and Green for disk activity. If the green LED is lit constantly and the console is not responding, it is carrying out a disk check and will come to life again in a few minutes when it has finished.

The "heartbeat" LED at the bottom right of the console should flash during normal operation. In the unlikely event that the heartbeat stops, press the panel reset button. This will restart the control panels of the console. The main operating system is not affected by the reset button, but the DMX outputs will be interrupted while the panels reset. The output of the console will resume as it left off when the reset has completed.



## 1.4 Loading and saving shows

You can save any number of different shows on the Diamond's internal hard disk. The Diamond will also autosave the show periodically.

### 1.4.1 Autosave

The Diamond will automatically save your show to its internal hard disk when you shut it down. It will also autosave the show every 30 minutes in case of power loss, and can keep multiple copies of the show allowing you to go back to different points in the programming. You can alter the time, the number of copies saved, or turn off autosave in the User Settings). The time remaining to the next auto save is shown on the status bar of the software; if you wish to delay an auto save by 10 minutes simply:

- 
- 1> Press the blue Setup button (bottom right)
  - 2> Press J [Delay autosave 10 minutes]
  - 3> The time to autosave will now be increased by 10 minutes.
- 

### 1.4.2 Manual save and load

You can also save your show at any time either with its current name or with a new name.

- 
- 1> Press the blue Setup button.
  - 2> Press D [Save Show].
  - 3> Press E [Use Current Show] to save the show with its current name. Press A [Overwrite Show] to display a list of existing shows on the softkeys; you can then select a show to overwrite by pressing its softkey. Or you can enter a new show name on the keyboard; D [Use time and date] will insert the current time and date into the filename for you.
  - 4> Press Enter. The show will be saved.
  - 5> Press Up to leave Setup mode.
- 

Shows are saved in the C:/Program Files/Avolites/Diamond4/ShowData folder, unless you change this in the User Settings.

The Diamond will automatically load the last show when it is turned on. If you want to load a different show:

- 
- 1> Press the blue Setup button.
  - 2> Press B [Load Show].
  - 3> Available shows are listed on the softkeys; press the key to load the show (the I and J keys show more pages).
  - 4> Press Up to leave setup mode.
- 

You can save any number of different shows on the Diamond's internal hard disk.

- You can update the DMX addresses of patched fixtures to make them match the addresses in an existing show file by pressing Setup then C [Load DMX Patch]. Fixtures will only be updated if the fixture type and handle number on the console match the type and handle number in the show file.

### 1.4.3 Saving shows for pre-Titan consoles

Shows saved on a Titan console cannot be loaded by consoles running older software. If you need to be able to do this, you can save the show as an earlier version which will load into a pre-Titan console, by using F [Save Show For Version 2].

## 1.5 Backing up the show to CD-ROM or USB drive

It's a good idea to regularly copy a backup of the show to an external storage device such as USB pen drive or CD ROM just in case something bad happens to the console. You can't do this from buttons on the console, you need to use the VDU and trackball to select options from the Diamond 4 window on the VDU.

It is also possible to set up a "live backup" system which will keep the show going if the console fails in some way; see section 11.3 on page 217.

### 1.5.1 Backup current show to USB pen drive

You can save the current show to a USB pen drive using the Save Show menu command on the VDU. You can't backup to CD-R this way, to write to CD-R (or if you want to backup an older show stored on the Diamond's hard drive) you need to copy the showfile across as shown at the bottom of the page.

1> *Insert a USB pen drive in a spare USB socket.*

2> *On the VDU screen, click on the File menu and select "Save Show" .*

3> *Pull down the "Save in" list and select the drive where you want to make a backup of the show (removable USB drive only; you cannot save to a CD drive this way).*

4> *Type a filename for the show in the "File name".*

5> *Click on Save.*

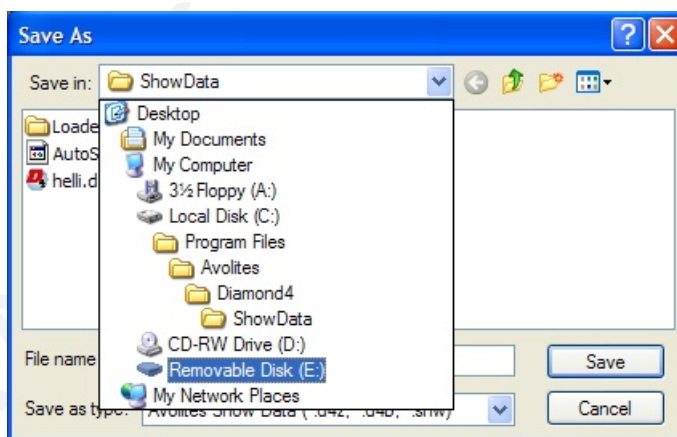

To reload a saved show from a removable device (including a CD) use the Load Show option on the VDU File menu.

### 1.5.2 Backup existing show files to USB pen drive

To backup existing show files to USB drive you need to copy the showfile across using Windows functions.

1> *On the VDU screen, click on the Windows Explorer icon (top right). (if you have the green windows Start button, click Start then My Computer.)*

- 2> Double click on "Local Disk (C:)"
- 3> Double click on the "Program Files" folder.
- 4> Double click on the "Avolites" folder, then double click the "Diamond4" folder, then double click the "ShowData" folder.
- 5> The VDU screen will show a list of the saved shows.
- 6> Click on the show you want to backup. If you want to backup more than one, hold down the Ctrl button on the keyboard while clicking them.
- 7> Right click on a selected file, and select "Send to" from the pop up menu which appears.
- 8> Select the removable USB drive where you want to make a backup of the show file(s). The file will be copied.
- 9> You cannot burn files to CD-R, you must use a USB drive.

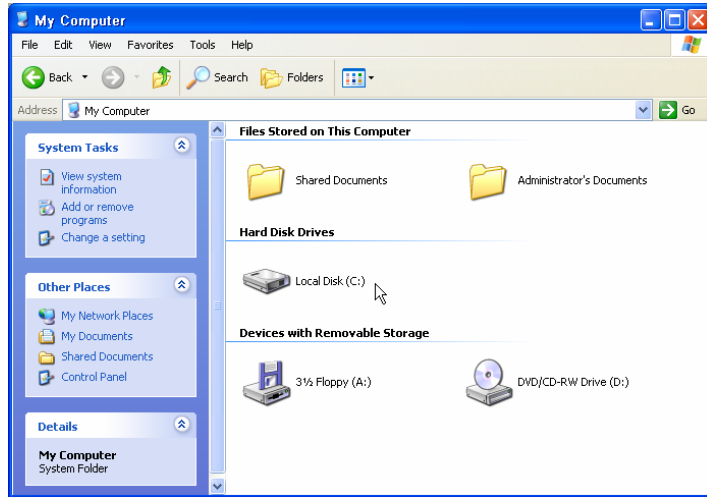

## 1.6 Clearing the console

When you start a new show on the Diamond it is usually a good idea to clear the console. All programming and patching is deleted, but user options are not changed.

If you want to use the same patch setup as another show, you can load the patch from a saved show using option C [Load DMX patch].

- 1> Press the blue Setup button.
- 2> Press A [Start New Show Wipeall].
- 3> Press A again to confirm.
- 4> Press Up to leave setup mode.

## 1.7 Using Presets on the Elite Version

The Elite version of the console does not have faders for the upper 48 preset handles, just Fixture and Palette buttons. You can use the lower 48 faders to control the upper presets using softkey D at the main menu. (Press Shift and Up to show the main menu).

To control the upper presets (49-96), press D so the option shows [Preset Faders control fixtures 49-96]. To control the lower presets (1-48) press D until the option shows [Preset Faders control fixtures 1-48]. The option toggles between the two settings each time you press the button.

## 1.8 Console Troubleshooting

If you have problems with the console, this section may help you

resolve it. If you are still having problems, the friendly folks at Avolites would be only too pleased to help you out; various means of contacting them are listed on the first page of the manual, just inside the cover.

Problem	Possible reasons/solutions
The desk doesn't switch on (the red led is off and the LCDs aren't backlit)	<ul style="list-style-type: none"> <li>• The power supply isn't plugged in and switched on.</li> <li>• The power lead is faulty or the plug fuse has blown.</li> <li>• The power button has become unplugged from the motherboard.</li> <li>• The CPU has overheated (check fan is set to full, fan is working, heatsink is secure, nothing obstructing airflow, etc)</li> </ul>
The VDU displays "keyboard error" and doesn't respond to the keyboard in the drawer	<ul style="list-style-type: none"> <li>• Unplug the power, count to 10, plug in and restart.</li> </ul>
The desk switches on (the LCDs are backlit) but no information is displayed on the LCDs	<ul style="list-style-type: none"> <li>• If the red and green leds are on together, then it is performing a disk check and you have to wait for it to finish.</li> <li>• Check that the CPU fan is running (if not, check cables to the fan).</li> </ul>
The desk shuts down on its own	<ul style="list-style-type: none"> <li>• The power supply should have been modified to be earthed to the chassis. If not, contact Avo.</li> <li>• The reset cable going from the DMX board to the motherboard should have been disconnected (if not, contact Avo).</li> <li>• The CPU has overheated (check fan is set to full, fan is working, heatsink is secure, nothing obstructing airflow, etc).</li> </ul>
The Desk stops outputting dmx and the heartbeat LED stops flashing	<ul style="list-style-type: none"> <li>• Press the reset button on the back of the desk.</li> <li>• Close the D4 software and wait for it to restart.</li> <li>• Close the D4usb program and restart it from the desktop.</li> <li>• Power down the desk and restart it.</li> </ul>
The D4 stops responding to input, but continues to output DMX	<ul style="list-style-type: none"> <li>• Check for any error message windows on the VDU and click on OK to close them (if Visualiser is on top, minimise it)</li> <li>• Close and restart the Diamond 4 application</li> </ul>

<p>The D4 stops responding and displays an error message saying that it has to shutdown</p>	<ul style="list-style-type: none"> <li>Click OK and wait for the application to restart itself. Contact Avolites and email us the report file in C:\avo\Report</li> </ul>
<p>When selecting Midi Timecode the Diamond shows an error message "Unable to find midi port"</p>	<ul style="list-style-type: none"> <li>Go into the console BIOS by restarting the console and pressing Delete during power up. Then go to Integrated Peripherals and set the Midi Port Address to 300. Press F10 to save and exit.</li> </ul>
<p>When selecting Midi Timecode the Diamond shows an error message "Unable to initialize directX component DirectMusic"</p>	<ul style="list-style-type: none"> <li>Download and install the latest version of DirectX from Microsoft's website <a href="http://www.microsoft.com">http://www.microsoft.com</a> To download the DirectX package onto your PC for installation onto the console, look for the "Redist" download (otherwise the site will attempt to use a smart installer which you cannot transfer to the console).</li> </ul>

Copyright Avolites Limited 2010

## 2. Patching

*This chapter contains: patching dimmers; patching moving light fixtures; checking the patching; changing the DMX address; deleting a patched fixture; patching options.*

Patching is the process where you tell the Diamond

- What type of lighting units you have connected to it
- What DMX addresses they are operating at
- Which DMX line (universe) each unit is connected to (there are 12)
- Which Preset Faders you want to use to access them

You should normally plan out the lighting rig in advance to allow the DMX addresses on your fixtures to be set up before they are rigged. The easiest way to do this is to patch the fixtures on the console, then read off the DMX addresses from the console (see section 2.1.4) and use them to set up the addresses on the actual fixtures. You can use the Diamond 4 simulator to configure the patch if you don't have access to the real console.

Alternatively you can allocate the DMX addresses to the fixtures yourself, and set up the console to match.

The Diamond's key must be set to Operate before you can patch.

### 2.1 Create

#### 2.1.1 Preset faders (handles)

To control intelligent fixtures or dimmer channels, they must be patched to a Preset. These are the faders, buttons and displays located in 2 rows along the top of the console. Each preset consists of:

- a fader, used to set the intensity of the fixture or dimmer
- a blue Select button which is used to select the fixture
- a grey Palette button which is used to store and select Palettes, Groups and various other things
- a space on the LCD display which shows what is controlled by the preset and what palette, group, etc is stored on the palette button.

The fader, buttons and display are together referred to as a handle.

The Preset/fixture page buttons are located below Softkey A in the column labelled "Fixture Bank". You can change the page at any time using the -1 and +1 buttons or press Select Fix Page and select a page from the Softkeys (or type in the new page number on the keypad). Palettes, groups and shortcuts have different page controls and won't

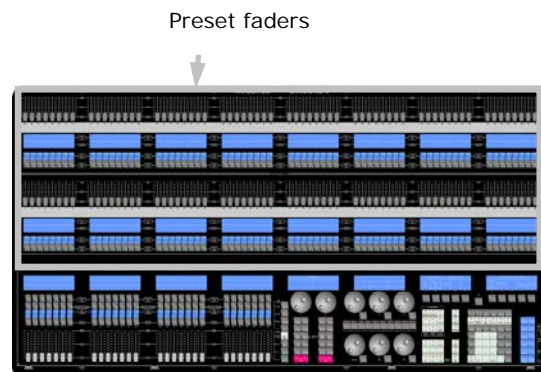

change when you select a different Preset page.

The Diamond allows you to allocate fixtures and dimmers to Groups, which can be useful if you usually select the same set of fixtures together. Groups are described in the next chapter.

### 2.1.2 Patching dimmers

Each dimmer channel is allocated to one preset. If you want to link dimmers together, you can allocate several to the same preset.

- 
- 1> *Press Patch, then A [Dimmers].*
  - 2> *Softkey A [Line=] shows you which of the 12 DMX output lines you are patching onto. Press A to change the line. Softkey B shows the DMX address about to be patched. You can change this by pressing B [DMX=x], typing in the new address on the numeric keypad and pressing Enter or just by typing in the new address on the numeric keypad.*
  - 3> *To patch a single dimmer, press a preset Select button. To patch a range of dimmers, hold down the Select button for the first dimmer in the range, then press the last Select button in the range. The range of dimmers will be patched to sequential DMX addresses.*
  - 4> *To patch another dimmer to the same handle, press B, type in the new DMX channel, press Enter, then press the preset Select button again.*
  - 5> *Repeat from step 2 for other dimmers.*
- 

- To see how DMX channels are patched, open the DMX window on the VDU screen. Press View (above the numeric keys), then keep pressing the down arrow to select "DMX" from the "View" menu. (or use the trackball or mouse in the normal Windows manner).
- You can make the display below the fader show the DMX channel it is patched to instead of the intensity. See section 2.1.4 on the next page.
- E [User Number=AUTO] allows you to tell the console to use either an automatically increasing number for the dimmer's User Number, or to use its DMX address.
- F [Press to show DMX channels] in the dimmer patch menu will turn on the output of the DMX channel which is about to be patched (so if the Diamond is about to patch channel 10, it will turn on that channel). This can be a useful visual check of which lanterns you are patching. Softkey G turns this off.
- The number in brackets below the DMX address on softkey B gives the Absolute DMX address, which takes the DMX line into account (line A=1 to 512, line B=513 to 1024, line C=1025 to 1536 etc).

### 2.1.3 Patching moving light fixtures

Moving light fixtures are more complicated to patch than dimmers because they have more attributes to control, such as pan, tilt, colour etc., whereas a dimmer channel just has intensity.

The Diamond uses a "personality" system to control fixtures. This means you don't have to know how each fixture works, you just tell the Diamond what you want to do and it will send the right control



commands. There is a personality file in the Diamond for most types of fixture, which tells it what attributes are available and how to control them. If the Diamond does not have the personality for your fixture, you can download further personalities from the Avolites website or Avolites can create one for you. See section 12 on page 222 for details of how to find personalities.

- 1> Press Patch (bottom right of console).
- 2> Press B [Fixtures].

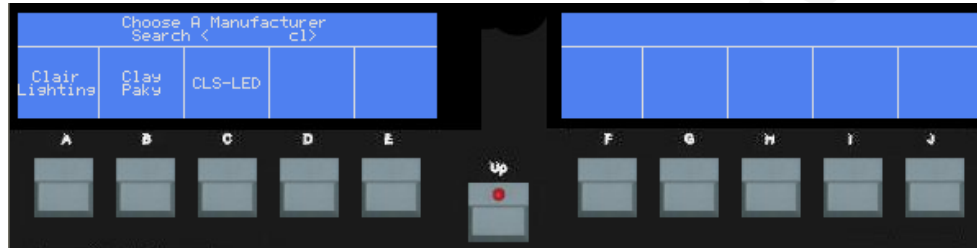

- 3> Select correct fixture manufacturer from the softkeys (I and J page through the list of manufacturers). Or type the first few letters of the name on the keyboard to search for that name.
- 4> Select correct fixture from the softkeys (I and J show other pages). Again you can type some letters to filter your search.
- 5> Select an operating mode for the fixture.
- 6> Softkey B shows the first free DMX address. Type the new address on the numeric keypad if you want a different one. Press A [Line=x] to patch to a different DMX line.
- 7> Press a Preset Select button to patch the selected fixture.
- 8> The display below the fixture will show what you have patched. You can show the DMX channel it is patched at by pressing Preset Mode View (below Softkey B) then C [DMX].
- 9> Repeat from 7 to patch more of the same fixture type. The DMX address automatically updates so you can just keep patching by pressing Select buttons.
- 10> Softkeys F G and H allow you to change the fixture being patched.

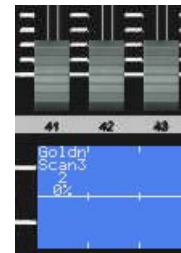

- You can patch a range of fixtures by holding down the first and last Select buttons of the range, in the same way as for dimmers.
- Unlike dimmers, you cannot patch more than one fixture onto a preset. If the preset is already used, the patch will fail.
- If a patch goes over the capacity of a DMX line, the Diamond will patch at the beginning of the next line. For example if you try to patch a Mac500 at channel A510, it will actually be patched at B1.
- If you are patching a fixture which uses a separate dimmer channel such as a VL5™, you can patch the dimmer channel onto the same handle as the moving light part of the fixture, so you can control it all together. This is called a Pending dimmer.

### 2.1.4 Checking the patching

If you need to read off the DMX settings for each fixture you have patched, you can display the DMX address like this.

- 1> Press Preset Mode View (below Softkey B).
- 2> Press C [DMX].
- 3> The displays below the fixture faders show the DMX addresses of each fixture, with the DMX line and address (e.g. A24 is address 24 on DMX line A).
- 4> Press View then A [Intensity] to go back to showing the fixture intensities on the displays.
- 5> Press View then a fixture select button to open a window on the VDU screen showing all the DMX details for that fixture.

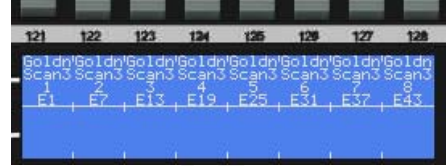

- The fixture display shows which DMX channel is controlling each function of the fixture, and also which wheels will control the attributes.

Dmx			Wheels			
Offset	Address	Control	Bank	4	5	6
1	A1	Iris	Intensity			
2	A2	Colour	Colour	Colour		
3	A3	Frost	C-Mix	Cyan	Magenta	Yellow
4	A4	Dimmer	Gobo 1	Gobo 1	Gobo 2	Gobo 2 Rot
5	A5	Pan	Gobo 2			
6	A6	Tilt	Beam	Iris	Zoom	
7	A7	Zoom	Effect	Frost	Focus	
8	A8	Focus	Special	Prism	Prism Rotation	
9	A9	Prism	Control			
10	A10	Prism Rotation	Softkey			
11	A11	Gobo 1				
12	A12	Gobo 2				
13	A13	Gobo 2 Rot				
14	A14	Cyan				
15	A15	Magenta				
16	A16	Yellow				

- Option D [Absolute DMX] on the View menu shows under the fader the effective DMX channel when the DMX universe is included (for example channel 10 on DMX line B is Absolute DMX 522; channel 1 on line C is absolute DMX 1536). The 8 universes of DMX produced by the console correspond to absolute DMX addresses 1 - 4096.
- Option E [Show User Fixture Numbers] will show your user defined numbers for the fixtures (see section 2.6.1 on page 133).

## 2.2 Edit

### 2.2.1 Changing the DMX address of a fixture

You can re-patch a fixture to a different DMX address or a different DMX output line. All programming is kept.

- 1> Press Patch (if you're not already in Patch mode).
- 2> Press F [Edit Fixtures]
- 3> Press B [Repatch a Fixture].
- 4> Press the blue Select button of the fixture you want to change.
- 5> To change DMX address, press B [DMX=x], type the new address and press enter
- 6> To change the DMX output line, press A [Line=x Press to Change]

*and choose a new output line by pressing A - H.*

*7> Press Enter to confirm the change.*

*8> Repeat from step 3 if you want to change other fixtures.*

- If the new DMX address already had another fixture or dimmer patched on it, the console will ask "Do you want to park fixtures?". If you select Yes, the previously patched device will be "parked" (see next section).

### 2.2.2 Parking fixtures

Sometimes you might need to rearrange the DMX patching of your rig. If you need to patch a fixture at a DMX range occupied by an existing fixture, you can "park" the previously patched device. All programming for the parked fixture is preserved, but you need to repatch it to a free DMX address (see section above) before you can use it again. The console display below the preset will show "park".

*1> Press Patch (if you're not already in Patch mode).*

*2> Press F [Edit Fixtures].*

*3> Press E [Park Fixtures]*

*4> Press the blue Select button of the fixture you want to park. You can hold a button and press a second button to park a range of fixtures.*

### 2.2.3 Setting legends

You can set a legend for each fixture or dimmer you've patched which is displayed below the fader. This can be really useful to help you identify the fixture.

*1> Press the blue Set Legend button.*

*2> Press the Select button for the fixture you want to legend.*

*3> Type the legend on the keyboard. The display below the fixture's fader and above Softkey C updates as you type to show you what it's going to look like.*

*4> Press Enter when you have finished.*

- The legend is limited to 2 rows of 5 characters.
- You can use E [Press To Latch Menu] to keep the Set Legend mode active if you want to set legends for lots of items without having to keep pressing the Set Legend button.

### 2.2.4 Updating personalities of patched fixtures

You can update the personalities of fixtures already patched, for example if an improved personality file is created.

*1> Press the blue Patch button (if not already in patch mode).*

*2> Press F [Edit Fixtures]*

*3> Press F [Update personality file].*

*4> Select the fixture type you want to update from the softkeys.*

*5> Press A [Browse For File] and follow through the softkeys to find the personality file you wish to use.*

6> *Press Enter to finish.*

---

- Additional fixtures patched in the current session will also use the new personality file. However once the show is reloaded or a wipeall is performed, any new fixtures patched will use the default personality. Previously patched fixtures will keep the new personality.

## 2.3 Copy

### 2.3.1 Copying a patched fixture

You might want to do this if you need an additional fixture of a type you've already patched and programmed. The new copy will come complete with all the cues and palettes of the original fixture you've copied.

The copied fixture will be "Parked" (have no DMX channel allocated) and you will need to repatch it before you can use it (see section 2.2.1 above).

---

- 1> *Press the blue Copy button.*
  - 2> *B [Press to include legend] allows you to either copy the legend as well, or if set to Disabled, the Diamond will generate a new legend.*
  - 3> *Press the Select button of the fixture you want to copy.*
  - 4> *Press the Select button of the empty Preset where you want to patch the copy.*
- 

- You can copy a range of fixtures by holding down the first fixture button of the range then pressing the last in the range. When selecting the destination for the copy you need to make sure there is enough space for all the copied fixtures, or the copy will fail.

## 2.4 Delete

### 2.4.1 Deleting a patched fixture

You can delete a fixture or dimmer from a preset if you patched it accidentally or if you change your rig and want to use the preset for something else.

---

- 1> *Press the blue Delete button.*
  - 2> *Press the Select button of the fixture you want to delete.*
  - 3> *Press the Select button again to confirm.*
- 

- All programming for the fixture is also deleted. You cannot undo deletion of a fixture or get the programming back by repatching a fixture to the same handle.

### 2.4.2 Deleting an individual DMX channel

You can delete an individual DMX channel from a preset:

---

- 1> *Press Delete.*
- 2> *Press B [Delete a DMX channel].*
- 3> *Press A to select the DMX output line.*
- 4> *Type the address.*

---

5> *Press Enter to confirm.*

---

- This is useful for deleting dimmer channels from handles which have multiple channels patched to them. Be careful not to delete individual channels out of fixtures using this function, as the whole fixture will be deleted and you will have to repatch the fixture and recreate all programming for it.

## 2.5 Moving

### 2.5.1 Moving a fixture to a different handle

You can move a dimmer or fixture from one handle to another using the Move function.

---

- 1> *Press the blue Move button.*
  - 2> *Press the Select button for the fixture you want to move.*
  - 3> *Press the Select button for the handle where you want the fixture to end up.*
  - 4> *E [Press to latch menu] keeps the Move mode active, so you can keep Moving things without having to keep pressing the Move button. Press Up to leave Move mode.*
- 

- You can move a range of fixtures by holding down the first fixture button of the range then pressing the last in the range, as with copying.

## 2.6 Advanced options

### 2.6.1 Set Fixture User Number

You can give each fixture a User Number to identify it. This allows you to select the fixture easily from the keypad. The Diamond allocates User Numbers automatically during patching but you can change them like this:

---

- 1> *Press Patch.*
  - 2> *Press F [Edit Fixtures].*
  - 3> *Press A [Set a Fixture User Number].*
  - 4> *Type the number you want to use on the keypad.*
  - 5> *Press the Swop button of the fixture to be numbered.*
  - 6> *Press other Swop buttons to continue numbering or press Up twice when finished.*
- 

- You can set the fixture number from the fixture's current DMX address using option A [Use DMX]. (If you subsequently repatch the fixture, the fixture number does not change).
- You select fixtures on the keypad using the Fixture button. See section 3.1.16 on page 144.
- You can display the User Fixture Numbers on the console displays by pressing preset mode View (below softkey C) then E [Show User Fixture Numbers].

### 2.6.2 Swap pan and tilt

This allows you to make the pan channel control tilt and the tilt control

pan. This is useful for moving-mirror fixtures rigged sideways.

- 
- 1> Press Patch.
  - 2> Press F [Edit Fixtures].
  - 3> Press C [Swap Pan Tilt]
  - 4> Select the fixtures to be pan-tilt swapped. They will highlight and display "Swap" to show you which ones are and aren't swapped.
  - 5> Press Up twice when finished.
- 

### 2.6.3 Invert channels

This option inverts individual channels of fixtures. Useful if you have a fixture which pans right when the rest pan left, saving a trip up the rig to set fixture options.

- 
- 1> Press Patch.
  - 2> Press F [Edit Fixtures].
  - 3> Press D [Invert Channels].
  - 4> Select fixture(s) to be changed.
  - 5> Press '@' button next to the wheel of the attribute you wish to invert. Setting is displayed in the attribute window - 'Pan' or 'Pan Inverted'.
  - 6> For attributes other than Dimmer, Pan or Tilt, select the attribute group using the Attribute buttons, then press the appropriate "@" button. Some attributes can't be inverted.
  - 7> Press Up twice to exit.
- 



- You can change the invert on multiple fixtures by selecting more than one, but the "Inverted" display will not show if there is a mixture of inverted and non-inverted fixtures in the selection.
- Some attributes cannot be inverted. If the attribute you want is not displayed above a wheel, then it cannot be inverted.

### 2.6.4 Setting DMX outputs

There are 8 physical DMX lines and 12 logical DMX lines. Any logical DMX line can be mapped to output out of a physical DMX line (i.e. one on the back of the desk) By default logical lines A – H output on physical lines A – H. However if you wish to change this:

- 
- 1> Press Patch
  - 2> Press J [Change DMX Line Mapping]
  - 3> Select the physical socket A-H on the back of the console you want to change
  - 4> Select the logical line you want to come out of this socket
- 

- Pressing J [Set to Default] in the Set DMX Outputs menu will return all DMX lines to their default mapping.
- To setup DMX lines over Ethernet, see section 0 on page 228.

### 2.6.5 Save Patch List

This option is useful if you want to document or print out the addresses of all your fixtures as they are patched on the console so they can be addressed before being rigged. Press I [Save Patch List] in patch mode.

After selecting this option you will be presented with a menu to select either a CSV (comma separated values) or TXT (text file). The TXT format has been specifically designed to print out in notepad.

This file is outputted into root of the C:\ drive. To find it simply double click on "My computer" then double click on "Local Disk (C:)". The file will be called PatchList.

## 2.7 Fixture Exchange

The Fixture exchange function enables you to replace fixtures which are used in your show with alternative fixtures, retaining important elements such as cue times, shapes and legends. It is an important feature for touring shows and venues with a high turnover of events.

For example, if you have programmed your show in a venue which has MAC 500s and are moving to a venue with VL6s you can exchange the MAC 500s for VL6s whilst retaining many elements of your show.

The pan, tilt and dimmer will always be preserved from one fixture type to the next, as will times, shapes and legends for recorded items.

In order to maximise the Exchange function, you should use Palettes to create your cues wherever possible. This will allow you to adjust for position differences and so on by reprogramming a few position palettes, rather than having to reprogram every cue.

Cues recorded with absolute values direct from the fixture(s) will need to be re-recorded, preferably using palettes.

Links from the palettes to groups, cues, chases and cue lists will also be preserved, so the show can be easily recreated by updating your palettes as normal.

Fixture exchange also gives you a powerful way to re-use an existing show with new lights, so you can give yourself a programming head start when faced with a new fixture.

It is always advisable to save your show before performing major changes such as fixture cloning. Should you change your mind, you will easily be able to return to your show to its previous state.

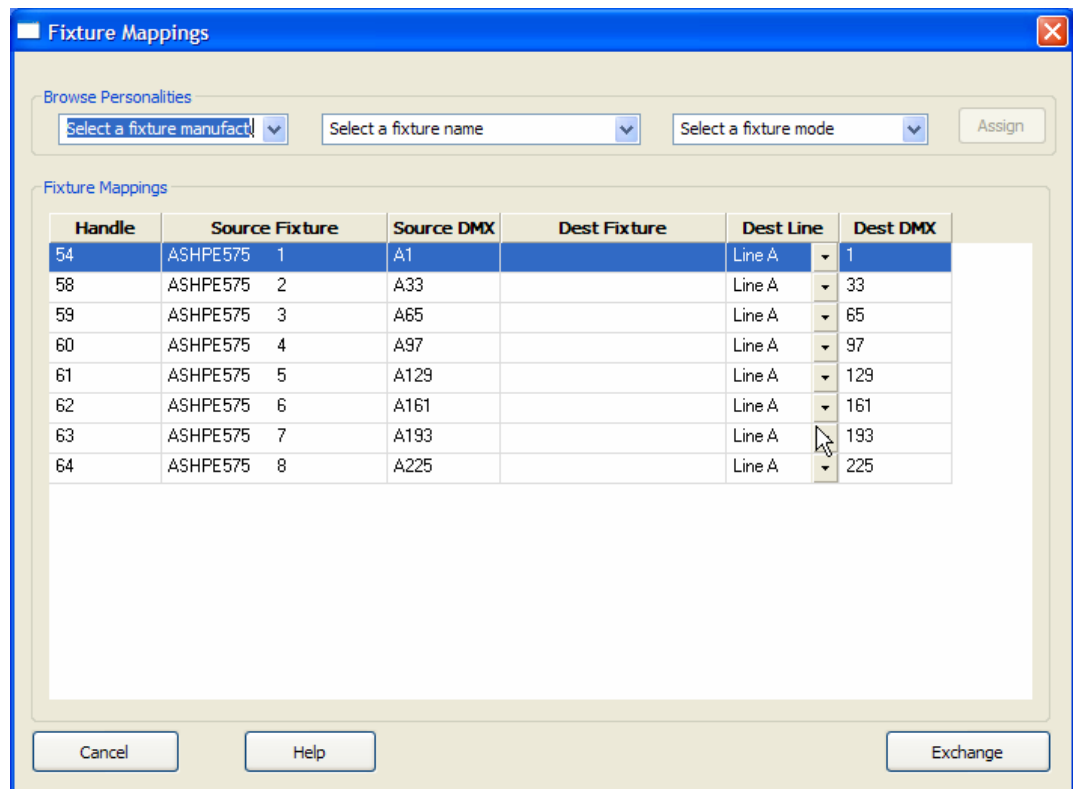

- 1> On the VDU click Tools, Exchange Fixture
- 2> Use the three dropdown boxes at the top of the screen to select the new type of fixture.
- 3> Select the existing fixture(s) you want to exchange. You can select individual rows or click and drag to select a range of fixtures.
- 4> Click Assign to set the new fixture type. The table can be sorted by any column by clicking on the head of that column
- 5> You can set the new DMX link and address for each fixture in the table.
- 6> When setting the DMX addresses some rows in the grid may change colour. Blue means that this is the currently selected fixture. Grey means that this fixture DMX address has been used elsewhere and this fixture will be parked when exchanged. Red means that this fixture has been assigned to an illegal DMX address.
- 7> Repeat steps 2 – 6 to exchange other fixture at the same time.
- 8> Once all the changes have been made click Exchange

Note: After exchanging fixtures you will have to update the palettes which used those fixtures. If you have trouble switching values off in a palette you need to re-record the palette with all the attributes in an attribute group with new values. You should then be able to switch off an attribute group as required.



## 3. Controlling dimmers and fixtures

*This chapter contains: Selecting fixtures and dimmers for control; changing attributes of the selected fixtures; the @ buttons; using groups; selecting fixtures one at a time from a group; the align and flip buttons; entering levels as numbers and selecting fixtures using numbers.*

When you are programming a show, and sometimes when you are running a show, you need to manually control the fixtures and dimmers to set the intensity, position, colour, etc. To do this you first select the fixtures you want to change using the Swop buttons, then you set the attributes of those fixtures using the Wheels and Attribute buttons.

### 3.1 Create

#### 3.1.1 Selecting fixtures and dimmers for control

To select the fixtures or dimmer channels that you want to control, you use the blue Preset Select buttons to load the fixtures into the Editor. You can select fixtures or dimmers individually, or several at once.

You can control dimmer channels and fixture intensity directly from the preset fader, or select the channels as described below and use the Dimmer wheel.

- 1> Press the blue Preset Select buttons for the fixtures you want. The display is inverted for selected fixtures (they are also shown in dark blue on the VDU screen).
- 2> To select a range of fixtures, hold down the Select button for the first fixture then press the Select button for the last fixture.

Here are some other things to know:

- Press Locate to light up the selected fixtures in open white. If you are using record by channel mode, these values won't be saved in a cue.
- If you want to move the fixture to a central position as well as turning it on in open white, press Shift and Locate.
- You can deselect a fixture by pressing the select button again.
- Once you have changed any attribute, pressing a preset Select button will deselect all fixtures and start the selection process again. All previously selected fixtures (since you last pressed Clear) stay in the programmer. They have their number inverted on the console displays, and are shown in blue on the VDU Stage View window. You can go back to a previous selection group by pressing shift and the ← → arrows next to wheel 3, see section 3.1.9.



Locate button

- Press Clear (top right of numeric keys) to deselect all fixtures and remove all changes from the programmer.
- You can select fixtures on another page by pressing one of the Fixture Bank +1 or -1 buttons (below softkey A). Or press the Select Fix Page button and select a page from the Softkeys (or type in the page number you want.) Palettes, groups and shortcuts do not change with the fixture page. The current fixture page number is shown on the display above the wheels.
- If a preset is active (the fader is raised) when you change page, you may want to control a fixture on the new page using the same preset. In this situation you have to match the fader level to the existing fixture level before the fader will take control. For example if preset 1 is on at 100%, you change to page 2 and want to control the fixture on preset 1 on page 2. If the page 2 fixture is currently Off, you will have to lower the fader to zero before it takes control. If the page 2 fixture is at 50%, the fader will take control when it matches the 50% value.
- You can select fixtures or dimmers and set levels using the keypad, see section 3.1.15.

### 3.1.2 Using presets on the Elite version of the console

The Elite version of the console does not have faders for the upper 48 preset handles, just Fixture Select and Palette buttons. You can use the lower 48 faders to control the upper presets using softkey D at the main menu. (Press Shift and Up to show the main menu).

To control the upper presets (49-96), press D so the option shows [Preset Faders control fixtures 49-96]. To control the lower presets (1-48) press D until the option shows [Preset Faders control fixtures 1-48]. The option toggles between the two settings each time you press the button.

### 3.1.3 Changing attributes using the wheels

“Attributes” are the functions of the fixture, like pan, tilt, colour, dimmer, etc. Attributes of fixtures which are selected into the editor are controlled using the wheels in the lower centre of the Diamond. The attributes available depend on the fixture type. Dimmer channels only have a dimmer attribute.

The bottom 3 wheels are always assigned to Dimmer, Pan and Tilt. The function of the top 3 wheels is assigned using the Attribute select buttons below them. The display area above the wheels shows which attribute is being controlled by each wheel, and the output value or setting.



Attribute controls

- You can directly control the intensity of the fixture/dimmer using the fader of the handle.
- Some attributes may need more than 3 wheels to control; pressing the Attribute select button again will assign the extra functions to the wheels. For example if your fixture has Iris, Frost,

Prism and Beamshape functions, when you press the Beam button you will get the first three, press Beam again to get the fourth function. If there is more than one "page" of attributes, the button flashes.

- You can also use palettes or the @ button to set attribute values.
- You can view the available settings (Gobo names, etc) of the top 3 wheels on the VDU by pressing the grey View button (near softkey H) then F [Wheels] (or View->Wheels on the VDU menu bar). If the wheels are controlling CMY colour mix, a colour picker is displayed, from which you can pick a colour using the trackball (see section 9.2 on page 200). If you have connected a media server using Avotalk, this window can show thumbnails of media clips (see section 14.8 on page 237).
- You can view the available attributes of a fixture on the VDU by pressing the Fixture View button (below B) then the select button for that fixture. A window will open showing the available attributes for the fixture you've selected.
- The wheels operate in an "acceleration" mode. If you spin the wheel quickly, the fixture changes in larger steps. If you move the wheel slowly, the fixture moves in smaller increments.
- Hold down Shift and spin the wheel to put it into "hyperdrive" mode. In this mode it will go from zero to full in a single revolution.
- The display above the wheels shows the output value either as a value range, or for attributes with defined position such as a colour wheel, as attribute names (such as "Open", "Red", "Orange" and so on as you turn the wheel).
- Sometimes control of an attribute is shared by several wheels, called Function Wheels. For example a rotating gobo attribute may have one function wheel to select continuous or indexed mode, and another function wheel to control rotation speed or position. This makes it much easier to find the function you want when the actual fixture may have both these functions (and more) controlled by different ranges of a single DMX channel.
- Some LED colour mixing fixtures have a Virtual Dimmer function (using the Intensity wheel) which offers intensity control by mastering the RGB levels when the fixture itself does not provide an intensity channel.

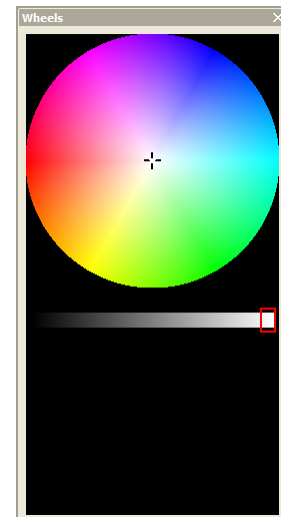
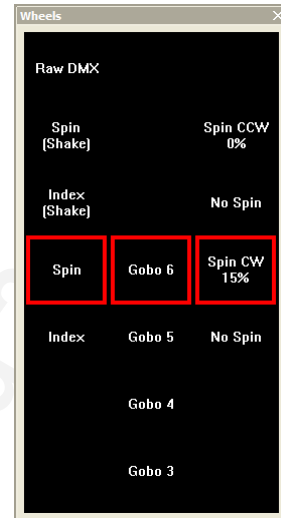

### 3.1.4 Attribute groups - IPCGBES

To make life a bit simpler, the Diamond groups together attributes which have similar effects, using the letters IPCGBES. You can see these letters below the Attribute select buttons.

- I-Intensity (dimmer, strobe shutter)
- P-Position (pan, tilt)
- C-Colour (colour wheel, CMY mixing)
- G-Gobo (gobo wheels, gobo rotate, gobo position)
- B-Beam (iris, focus, zoom, beam shaper)
- E-Effects (prism)
- S-Special (motor speeds)

These groups are used to select which attributes you want to work with in many of the functions on the console.

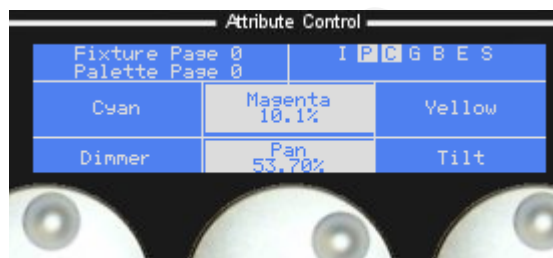

The top line of the display above the wheels shows which of the IPCGBES groups have been changed (which ones have settings in the programmer).

### 3.1.5 Selecting named attributes (Shift+@ button)

You can select particular colours and gobos from the softkeys by name. This can be a lot easier than finding them on the wheels.

- 1> Press the attribute button you want to set (e.g. Colour).
- 2> Press Shift and the "@" button below the wheel function you want to set. The display above the wheels shows you which attribute is controlled by each wheel.
- 3> The softkeys give a list of values available for the attribute.
- 4> Press a softkey to set that value (I and J change pages).
- 5> Press Up twice to get back to normal.

- An option in the user settings allows you to access this function without pressing shift (just press the @ button). If this option is turned on, the normal @ menu is accessed using Shift @.

### 3.1.6 Other attribute control functions (@ button)

The @ button options allow you to do various useful things.

- A [Remove Attribute From Programmer] removes the selected attribute from the programmer so that it will not get stored in any cues you record. This is useful if you accidentally change something but don't want to record the change.
- B [Switch On Attribute] puts the attribute into the programmer without you having to change the value
- C [Switch Off Attribute] labels the attribute as being "off", effectively removing it from the programmer. See section 6.3.3 on page 165 for an explanation of "Off".
- D [Select from table] allows you to recall a particular setting (such as "Green") from the softkeys (same as Shift+@, see previous section).
- E [Input Named value] allows you to search for a particular setting whose name you type on the keyboard (e.g. you can type "Green" to set the fixtures to Green). The softkeys will change as you type to show all attribute values which match what you've typed.

- F [Hold <attribute>] and G [Release <attribute> from Hold] allow you to hold the current value of an attribute. The current value will remain regardless of interaction from playbacks or the programmer. Only currently selected fixtures are released when G [Release] is pressed.
- The @ button lights up when its attribute is in the programmer.

### 3.1.7 Entering attribute values numerically

You can directly enter values for fixture attributes if the attribute has a range.

- 
- 1> *Select the fixtures to be set by pressing their Select buttons.*
  - 2> *Select the attribute to be set by pressing the @ button next to the appropriate wheel. Use the Attribute buttons to select a different group of attributes to the top wheel.*
  - 3> *The top line of the display above softkeys A-E will show the range of values available. If the range is "0-0" then you can't set a value this way.*
  - 4> *Type the value to set and press Enter.*
  - 5> *The attribute will be set to the value you entered.*
- 

### 3.1.8 Using groups

You can create groups of fixtures or dimmer channels, to make selecting them faster. You can, for example, make a group for each type of fixture, or group by stage left / stage right, etc. You can then select all the fixtures by just pressing a grey Palette button.

- 
- 1> *Select the fixtures/dimmers you want in the group (the order in which you select them will also be stored in the group).*
  - 2> *Press Shift and Rec Group (above the numeric keys).*
  - 3> *Press the grey Palette button where you want to store the group.*
  - 4> *Press Clear then repeat from 1 to store other groups.*
- 

- To select all the fixtures/dimmers in a group, just press the grey palette button for the group.
- You can set a legend for the group button using the Set Legend button.
- The order in which you originally selected the fixtures when creating the group is also stored. This takes effect when you use the last fixture – next fixture functions described in the next section, and when you use Shapes, Fan mode and Fixture Overlap functions.

You can also recall a group by doing the following:

- 
- 1> *Press the grey Group button.*
  - 2> *Type in the number of the group you want to recall.*
  - 3> *Press Enter.*
- 

### 3.1.9 Stepping through selected fixtures one at a time

If you have selected a range of fixtures, or a group, the Diamond has functions to step through the selected fixtures one at a time. This can make it easier to program a range of fixtures because you don't have to select each one manually.

This mode uses the ← ALL → buttons to the right of Wheel 3.

- 
- 1> *Select a range of fixtures or a group.*
  - 2> *The ← and → buttons will select the fixtures in the range one at a time (in the order you selected them). The ALL button will select all fixtures in the programmer (everything which has been selected since Clear was last pressed). Shift+ALL will deselect everything.*
  - 3> *Press Shift and the arrow buttons to go through previously selected groups of fixtures. You can go back through all selections until the last time you pressed Clear.*
- 

- The Hilight function can be used to highlight the output of the selected fixture, see the next section.

### 3.1.10 Highlighting the selected fixture

When stepping through a fixture selection using the ← ALL → buttons, you can highlight the selected fixture on stage. This makes it very easy to see which fixture you are controlling. The other fixtures in the selection go to a dimmed LoLight level..

Press the HiLight button to enable highlight mode. The arrow button LEDs flash when in highlight mode. Press HiLight again to disable highlight mode. When you are in highlight mode, the highlighted attribute is overridden and any changes you make to it are not stored in the programmer (so if the highlight uses intensity, you cannot change the intensity of the fixture).

You can set custom HiLight and LoLight states for a particular fixture type by setting up a fixture and pressing Shift+HiLight or Shift+LoLight. The HiLight and LoLight states normally only set the intensity but you can change them to set any attributes; however remember that you cannot program any attributes used to generate the highlighted state.

- 
- 1> *Select a fixture, and set its attributes to the custom highlight or lilight state you want.*
  - 2> *Press Shift+Highlight (or Shift+Lolight to set lolight state).*
  - 3> *The Hilight Record Mask is displayed. Select which attributes you want to record in the Hilight state and which you wish to exclude by pressing the appropriate softkeys.*
  - 4> *Press Enter to record the Hilight state.*
- 

### 3.1.11 Select odd or even fixtures out of a selection range

If you have a range of fixtures selected, you can change the selection to only the odd or even fixtures using F [Odd Fixtures] and G [Even Fixtures] from the fixture selection menu (press the grey Fixture button to the top left of the numeric keypad).

### 3.1.12 Inverting fixture selection

You can invert the fixture selection so that everything which was selected is deselected, and everything which was not selected becomes selected. Press J [Invert Fixture Select] from the fixture selection menu (press the grey Fixture button to the top left of the numeric keypad).

### 3.1.13 Selecting fixtures which are using a palette (Sel If)

It can sometimes be useful to reselect all fixtures which are using a certain palette, for example to select all fixtures in Red to change them

to another colour. The Sel If function will automatically select all fixtures in the programmer which are using a certain palette.

- 
- 1> Press Sel If (above numeric keys).
  - 2> Press a Palette button.
  - 3> All fixtures in the programmer using this palette will be selected.
- 

### 3.1.14 The Align and Flip functions

The Align function allows you to copy an attribute from one fixture to others. This can be useful if you want to set a row of scans to have the same tilt position, or if you want to copy a colour from one fixture onto other fixtures.

- 
- 1> Select the fixture to use as the reference.
  - 2> Select the other fixtures you want to align to the first one.
  - 3> To copy all attributes, press ML Menu (below softkey C), then C [Align Fixtures].  
To only copy some attributes, press ML Menu, then D [Align Fixtures By Attribute]. Select which attributes you want to copy using the softkeys, then press Enter.
  - 4> The selected attributes will be copied to all the selected fixtures.
- 

- If you use a group to select the fixtures, the one you selected first when you recorded the group will be the reference fixture.
- If Tracking mode is on (see section 3.2.1), aligning the Pan/Tilt attribute will cause all the fixtures to point at the same place on the stage rather than copying the actual Pan/Tilt values.

The Flip function is used with moving head fixtures. This type of fixture usually has two possible pan and tilt positions for each point on stage, and the Flip button alternates between them. This allows you more freedom to make movements without hitting the pan stop.

- 
- 1> Select the fixtures to flip.
  - 2> Press Flip (next to wheel 3).
  - 3> The selected fixtures will flip to their alternate position.
- 

- The other functions on the ML menu are described at the end of the chapter.

### 3.1.15 Selecting dimmers and setting intensity levels on keypad

You can set levels using the numeric keypad as you would on a theatrical lighting desk. If you are used to doing this, it can be faster when plotting dimmer levels for a scene than using the select buttons and the wheels. This is done using the Fixture button above the numeric keys.

- 
- 1> Press the Fixture button (top left of numeric keys). Press A [Select by Desk Handle] if this mode isn't already selected.
  - 2> Type the dimmer or fixture handle number (as shown on the display below the fader; not the DMX channel) on the keypad.
  - 3> Press Dim@ (bottom right of numeric keys).
  - 4> Press 0 - 9 for the intensity (0=0%, 1=10%, 2=20%, 3.5=35%), or Dim@ again for 100%.
  - 5> Press the decimal point key and another digit for more accurate
-

*control.*

---

Other things you can do while in Fixture mode:

- You can allocate your own numbers to fixtures and dimmers and select them using B [Select by User Number]. See section 2.6.1 on page 133 for details of how to allocate user fixture numbers.
- The softkey options on the Dim@ menu are A [Blackout], D [+5%], E [-5%] (the last two increase or decrease the level by 5%).
- You can select multiple dimmer handles (which you can then control using the wheels) using the THRO button. Press Fixture, enter the first dimmer number, press THRO, then the last dimmer. For example 1 THRO 10 would select dimmers 1 to 10.
- You can also set multiple dimmers to the same level using THRO. Enter first dimmer number, THRO, last dimmer, DIM@, level. For example, 1 THRO 10 DIM@ 5 would set dimmers 1 to 10 to 50%.
- On the Fixture menu, Softkeys A [Select by desk handle] and B [Select fixture type] lets you tell the console the type of fixture you are working with. Normally it is set to [desk handle] and will select any type of fixture using the preset/handle numbers. If you set it to a particular fixture type, e.g. dimmer, it will only select dimmers, starting at the first dimmer patched, so selecting 1 THRO 10 would select the first 10 dimmers, wherever they are patched, using the fixture numbers as shown on the display below the preset faders. You can set the option to any fixture type you have patched on the console. See next section.
- Softkey F [Curve] lets you select the dimmer curve for the selected dimmers or fixtures. This allows you to set channels to be "switching" and to change how the dimmer tracks the fader. The available dimmer curves are listed in section 11.4 on page 218; press J to go to the second page or I to go back to the first page.

### 3.1.16 Selecting fixtures from the keypad

If you have got a large number of fixtures patched across several pages, it can be easier to select them from the numeric keypad.

- You can allocate your own numbers to fixtures and dimmers (and groups and palettes). You can choose these to be lot more logical than the automatically allocated "desk handle" numbers. . See section 2.6.1 on page 133 for details of how to allocate user numbers.

- 
- 1> Press the Fixture button (top left of numeric keys).
  - 2> The console needs to be in "User Number" selection mode (the bottom line of the display above softkeys A-F showing "Fixture type = User Number"). If not, press C [Select User Number]
  - 3> Type the user number of the first fixture to be selected on the keypad.
  - 4> Press THRO (right of numeric keys).
  - 5> Type the user number of the last fixture on the keypad.
  - 6> Press Enter. The fixtures will be selected.
  - 7> Press Exit or Up to get back to normal.
-



### 3.1.17 Fan mode

Fan mode automatically spreads out the values on a selected range of fixtures. If used on pan and tilt, the result is spreading out “rays” of light beams. The first and last fixtures of the range are affected most, and the central fixtures are affected least. The amount of fan can be set using the attribute wheels.

As with shapes, the order in which you select the fixtures sets how the fan effect works. The fixtures you select first and last will be the ones which change most. If you use a group to select the fixtures, the order you selected the fixtures when you recorded the group is used.

The fan effect, while normally used on pan or tilt attributes, can be applied to any attribute.

- 
- 1> *Select the fixtures you want to fan.*
  - 2> *Press Fan.*
  - 3> *Set the amount of fan using the attribute wheels.*
  - 4> *The display shows which attribute is being controlled by each wheel. You can Fan any attribute.*
  - 5> *Turn off Fan by pressing the Fan button again when you have finished.*
- 

Fan mode needs to be used on at least 4 fixtures to give good effects. If you have an odd number of fixtures, the central fixture will not move in fan mode.

Press the Fan button again to leave Fan mode. Any effects you have set will remain in the programmer.

- It's fairly easy to accidentally leave Fan mode turned on and be very confused about why the wheels aren't working properly, so turn it off as soon as you have completed the effect.

## 3.2 Advanced options

### 3.2.1 The ML menu and Tracking

The “ML menu” (Moving Light menu) button allows access to some handy features for moving lights.

A [Remove fixture from programmer] allows you to remove fixtures which are selected from the programmer. This can be useful if you have changed a fixture you didn't want to include in a cue – just select the fixture, then use this option.

B [Invert fixture selection] deselects fixtures which are selected, and reselects fixtures which have previously been selected (since Clear was last pressed). Previously selected fixtures are shown with inverted numbers on the console displays.

C and D [Align Fixtures] are described in section 3.1.14 on page 143.

E [Fixture macro] is used to run “macros” which are used to strike lamps or reset fixtures, etc. These features often require a sequence of levels to be sent on different control channels. Available macros for the selected fixtures are shown on the softkeys.

F and G [Hold/Release Selected Fixtures] allow you to hold fixtures in their current positions. Changes on the console will not affect the

fixtures until you select G [Release...].

H [Define Stage] and I [Recall Stage] are used to define the stage for the Diamond's 3D tracking mode. See section below.

J [Tracking] allows you to turn the 3D stage tracking mode off or on. When tracking mode is on, the pan and tilt controls set the position on the stage rather than absolute DMX values. This makes it very easy to point a number of fixtures at one spot. You need to Define the Stage (see next section) before you can use Tracking.

### 3.2.2 Training the console for Tracking mode

The Diamond can learn the layout of the stage and the rig you are using. This enables it to calculate where it needs to point each light so that they all hit the same place on the stage. This is called Tracking mode and it is a very powerful feature of the Diamond. If you need to program lots of "specials" to light people in different places, Tracking mode can really help you out. It can also be used to spot people in real time using multiple fixtures (such as when the lead singer decides to stand 3 feet to the left of your programmed position).

You need to mark a square on the stage, ideally the sides of the square need to be half the depth of the stage but as long as it's square and you can point all the fixtures at the corners, the size is not that important.

- 
- 1> Press ML Menu then H [Define Stage].
  - 2> Select all the fixtures you want to use for Tracking.
  - 2> Point all the fixtures so they light someone standing at the back left hand corner of the square (don't light a circle on the floor, or your lights will be pointing at peoples' feet all the time).
  - 3> Press A [Top left]. This stores the positions.
  - 4> Point them all so they light someone standing at the back right hand corner, then press B [Top right].
  - 5> Repeat for the front corners of the stage using options C and D to store the positions.
  - 6> Press F [Calibrate] to complete the process.
  - 7> Press Up when the display shows "Calibration complete".
  - 8> Press J [Tracking] to enable Tracking mode (option shows [Tracking ON] when tracking is enabled).
- 

- You can recall a position you have already set, if you want to edit it, using I [Recall Stage] then A B C or D to recall one of the positions.
- You need to make sure you are lighting a person rather than making a spot on the stage, because otherwise the beams will cross over at the wrong place. If you can't find a handy spare person, use a plastic cup or a light coloured item of clothing over the end of a mic stand at head height.
- If you are using moving head fixtures, you need to ensure when hanging them that the pan stop is on the side away from the area to be lit, or the fixtures will not be able to track over the whole area. You also need to keep the Tilt value less than 50%, or the heads may "flip" when you track into some areas.
- Fixtures which have not been trained for Tracking will operate as normal when tracking mode is enabled.

## 4. Palettes

*This chapter contains: About palettes; shared and normal palettes; recalling a palette; storing a palette; palette masks.*

When programming a show you will find that you frequently use certain positions, colours, etc. The Diamond lets you store these settings so you can recall them at the touch of a button rather than having to find them on the wheels every time. Palettes are stored and selected using the grey Palette buttons and you can set legends for the palette values so that you know what you're getting.

### 4.1 Create

#### 4.1.1 Palette values stored as a reference

The most important thing about palettes is that when you use a palette value in a cue, the Diamond stores a reference to the palette, rather than the actual value. This means that if you program your cues using palettes, you can easily change all the positions in your show just by reprogramming a few palette entries rather than having to reprogram all the cues. This is handy if you are touring and have to cope with different stages or truss heights every show.

- If you use Record Stage mode when recording cues, palettes are not stored; instead the absolute output values are used.

#### 4.1.2 Shared and Normal palettes

Palette entries can be shared or normal. This is selected when you record the palette.

- **Shared:** Used for settings which are the same for all fixtures of the same type, such as Colours or Gobos. When you save a Shared palette for one fixture, it is then available to all fixtures of the same type. If you patch more fixtures of that type at a later date, they will also be able to use all the shared palettes. Shared palettes are shown with a "S" symbol on the display as shown for Pal 4 in the picture.
- **Normal:** For settings which need to be individual for each fixture, such as positioning and image focus. You can add positions for more fixtures to a Normal palette just by saving the palette again with the new fixtures set.

Clr	SP	Clr	SP	Clr	SP	Clr	SP
1200	1200	1200	1200	1200	1200	1200	1200
1	2	3	4	1	2	3	4
47%	0%	0%	0%	47%	0%	0%	0%
Pal 1	Pal 2	Pal 3	Pal 4 S	Pal 1	Pal 2	Pal 3	Pal 4 S
1	2	3	4	1	2	3	4
I	PK	P	C	I	PK	P	C

#### 4.1.3 Which attributes are stored in palettes

A palette entry can store any or all attributes of a fixture, so you could store position, colour and gobo in the same palette entry. However, it's easier to operate the Diamond if you have some palettes which only set positions, some for colour, some for gobo and so on. It's also best to group similar palettes together on the console buttons to make them easier to find, so have an area for Colour palettes, and another area for Position palettes, and so on.

### 4.1.4 Storing a palette

This is how you save a palette value:

1> Press Clear to clear the programmer.

2> Select the fixtures for which you want to store palette values.

3> Using the attribute buttons and wheels, set the attributes you want in the palette entry. You can store any or all attributes of a fixture in each palette entry.



Rec Palette button

4> Press Rec Palette (below softkey D).

5> Select which attributes are to be recorded in the palette. Softkey C turns on all attributes. D turns them all off, and you can turn them back on individually using A [Press to set mask]. It's best to save only one type of attribute (e.g. Tilt/Pan). The top line of the display shows you which attributes will be saved.

6> Select whether all modified fixtures are to be saved (softkey G) or just currently selected ones (softkey F).

7> Select if the palette is to be Shared or Normal (softkeys I and J).

8> Press a grey Palette button to store the palette.

- F [Save selected fixtures only] is useful if you are in the middle of programming and don't want to have to press Clear. You can save only the fixtures which are selected and ignore all other fixtures in the programmer.
- When setting the Mask options using A [Press to set mask] there are three possible settings for each attribute group:
  - [Exclude All <attribute> channels] will miss out the attribute from the saved palette
  - [Save All <attribute> channels] will store the current setting of the attribute even if it's not in the programmer
  - [Save <attribute> channels in the programmer] will store the current setting of the attribute only if it is in the programmer. This last option is like "Record by channel" mode.

## 4.2 Playback

### 4.2.1 Recalling a palette value

To recall a palette value, this is what you do:

1> Select the fixtures to be changed. Shared palettes can be set to any fixture of the same type. Normal palettes will set individual values to each fixture.

2> Press the grey Palette button you want to recall. The palette will be set to the selected fixtures.

- You can make palettes fade over a time when you recall them, see

section 4.6.1 below.

- You can use the Quick Palette function to recall a palette to all the fixtures it applies to – select a palette with no fixtures selected. (The Quick Palettes option in the User Settings must first be enabled).

### 4.2.2 Palette pages

You can select different pages of palettes using the Palette Bank –1 and +1 buttons below softkey B. Or you can jump to a page by pressing the Select Pal Page button and selecting a page from the options on the softkeys (or by typing the page number on the keypad and pressing Enter).

The current Palette page is shown on the display above the wheels.

- You can create a shortcut on a Palette button which will set up a particular playback page, fixture page and palette page. See page 199.
- Shortcuts on the palette buttons do not change with the palette pages and remain on the same buttons.

You can also recall a palette by doing the following:

- 
- 1> *Select some lights*
  - 2> *Press the grey Palette button*
  - 3> *Type in the number of the palette you want to recall.*
  - 4> *Press Enter*
- 

## 4.3 Edit

### 4.3.1 Editing palettes

- You can edit a palette entry by recalling it, making the changes you want, then saving the new information back on top of the existing palette entry. Anything you haven't changed will not be affected, values you have changed or added will be amended.
- You can add additional fixtures to a palette without affecting existing ones. For example, if you have colour palettes for Mac 600s, you can add colours for your Mac 500s without affecting any previously recorded values in the palette.
- You can remove attributes from palettes using the Off function, see section Removing attributes from cues using "Off" on page 165.

### 4.3.2 Setting legends for palettes

You can enter a legend for each palette which is displayed on the screen immediately above the buttons.

- 
- 1> *Press the blue Set Legend button.*
  - 2> *Press the grey palette button for the palette you want to legend.*
  - 3> *Type the legend on the keyboard. The display above the palette button and above Softkey C updates as you type to show you what it's going to look like.*

4> Press Enter to when you have finished, then press Up to leave Set Legend mode, or repeat from 2 to set more legends.

- The attribute groups used in the palette are displayed below your legend, so for example Position palettes will show a P, colour palettes a C and so on. If more than 3 attribute types are saved, the display shows the first 3 with a "..." (as shown in palette 47).

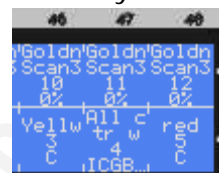

## 4.4 Delete

### 4.4.1 Deleting palettes

You can delete a palette entry by pressing the blue Delete button, then the grey Palette button to be deleted. Press the palette button again to confirm the deletion.

## 4.5 Moving

### 4.5.1 Moving palettes

To move a palette:

- 1> Press the blue Move button (bottom right of console).
- 2> Press the Palette/Flash button of the palette to be Moved.
- 3> Press the Palette/Flash you want to Move it to.
- 4> E [Press to latch menu] keeps the Move mode active, so you can keep Moving things without having to keep pressing the Move button. Press Up to leave Move mode.

## 4.6 Timing

### 4.6.1 Fading a palette

A timed palette is a very useful tool allowing easy "busking" of shows. When a palette is recalled in this way, a time is added and the palette fades in over that time.

- 1> Select some fixtures
- 2> Type in the time for the palette on the keypad
- 3> Press the palette button

Palette fading can be very useful when recalling a palette live during a show, as you can smoothly move fixtures to a new position or change colour slowly (on colour mixing fixtures).

Palettes applied with a fade time do not get put into the programmer, so will not be saved in any cues; don't use fade times when programming. This is to ensure that when used in a live situation, the next cue will override the palette and play back as intended. Also, the Clear button does not affect timed palettes.

There is a user setting under the Panel tab which allows you to access this function from any menu, not just the top level root menu.

### 4.6.2 Storing times and overlap in palettes

You can store fade times and overlap settings in a palette, which will automatically take effect when the palette is recalled. This again is a useful feature when busking a show, enabling great effects to be

created on the fly.

- 
- 1> Press A [Set Times] from the top level menu.
  - 2> Press the palette button to be edited
  - 3> Use the menu softkeys to set the times required (see page 167)
- 

Copyright Avolites Limited 2010

Copyright Avolites Limited 2010



## 5. Shapes

*This chapter contains: Selecting a shape; changing the size and speed of a shape; spreading a shape across multiple fixtures; editing shapes which are running.*

The Diamond, in common with other Avolites consoles, has a shape generator (sometimes known as an Effects Generator on other consoles). This allows you to quickly create exciting light shows using lots of movement and changes, with the minimum of programming.

A shape is simply a sequence of values which can be applied to any attribute of a fixture. A circle shape, for example, applied to the pan and tilt attributes, would cause the fixture to move its beam around in a circular pattern. You can set the centre point of the circle, the size of the circle and the speed of the circle movement.

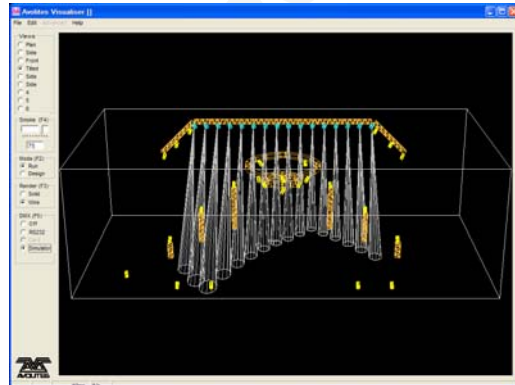

In addition to position shapes, there are a large number of other shapes available in the Diamond. The shapes are defined for a particular attribute such as colour, dimmer, focus and so on. Some shapes will not work with some fixtures; focus shapes, for example, can produce nice "focus pull" effects on fixtures which have DMX focusing, but will do nothing on fixtures which don't have focusing.

When you use a shape with more than one fixture, you can choose to either apply the shape identically to all the fixtures, or offset them so that the shape runs along the fixtures creating "wave" or "ballyhoo" type effects. This is called the *Phase* of the shape.

### 5.1 Playback

#### 5.1.1 Creating a shape

To create a shape you simply pick it from a list on the softkeys. Shapes are listed using the IPCGBES attribute groups, so you can pick from a list of Intensity shapes, or a list of Pan/Tilt shapes, or Colour shapes, and so on. You can also pick from a list of All Shapes.

When you choose a shape, it will be applied to all selected fixtures.



Shape button

- 1> *Select the fixtures the shape is to be applied to.*
- 2> *Press the Shape button (to the right of Wheel 3).*

- 3> Press A [Create] to start a new shape.
- 4> Press a softkey to select the attribute type to use in the shape or press H [All shapes] for a full list.
- 5> Press a softkey to select a shape.
- 6> The shape will be applied to all selected fixtures.

- Shapes are based on the current settings of the fixture, so a circle would move around the current pan-tilt position of the fixture.
- You can change the base value of a shape (e.g. the centre of a circle) by changing the attributes using the wheels in the usual way. You can reduce the Size to zero (see next section) to help you see what the base value actually is.
- You can run more than one shape at a time by repeating the above procedure. You can run several shapes on one fixture.
- Press Shape then then B [Edit] to show what shapes are running.
- If you apply the same shape to two different groups of fixtures, the shape will appear twice on the shape list. You can edit the two shapes separately to give different directions, speeds etc (see later)
- Each shape is designed to work on a particular attribute. Obviously if the fixtures don't have the attribute, you will not see any effect if you use the shape.
- Each shape has a default size and speed setting (defined in the personality file).

### 5.1.2 Changing size and speed of a shape

It is easy to change the size and speed of a shape after it has first been created.

- 1> Control the speed of the shape using wheel 4.
- 2> Control the size of the shape using wheel 5.
- 3> The size and speed is shown above the wheels on the display.

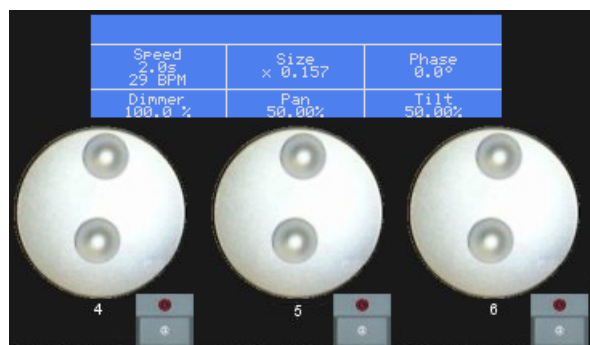

Other things to know about size and speed of shapes:

- If you have more than one shape running, the controls operate on the most recent one. You can edit the parameters of any shape that's running using the Edit Shape function, see section 5.2.1.
- You can enter a speed on the keypad by pressing the @ button for wheel 4. Type the speed in seconds and press Enter, or type the BPM speed and press A [Set BPM]. You can also enter a size on the keypad by pressing the @ button for wheel 5.
- The minimum size is zero. This will "hide" the shape, and the fixture will resume its previous settings. The shape is, however, still active.

- If you change any fixtures while running a shape, the wheels will revert to attribute control. You can get the Shape controls back by pressing the Soft Key button (below wheel 6)

### 5.1.3 Changing the phase of a shape across multiple fixtures

Shapes get more interesting (and look more impressive) when you apply them to multiple fixtures. The Diamond lets you control how a shape is phased across several fixtures. You can either set the phase in degrees, or you can specify the number of fixtures before the shape repeats itself.

The sequence of the shape across the fixtures is controlled by the order in which you selected the fixtures when you created the shape. You can change this order, see section 5.2.2.

- 1> Set the phase using wheel 6.
- 2> Alternatively, type in a value for the phase by pressing the "@" button below wheel 6 and enter the value on the numeric keys.
- 3> Or, if you want the shape to repeat every 4 fixtures, press @, type 4 and press A [Set Part].

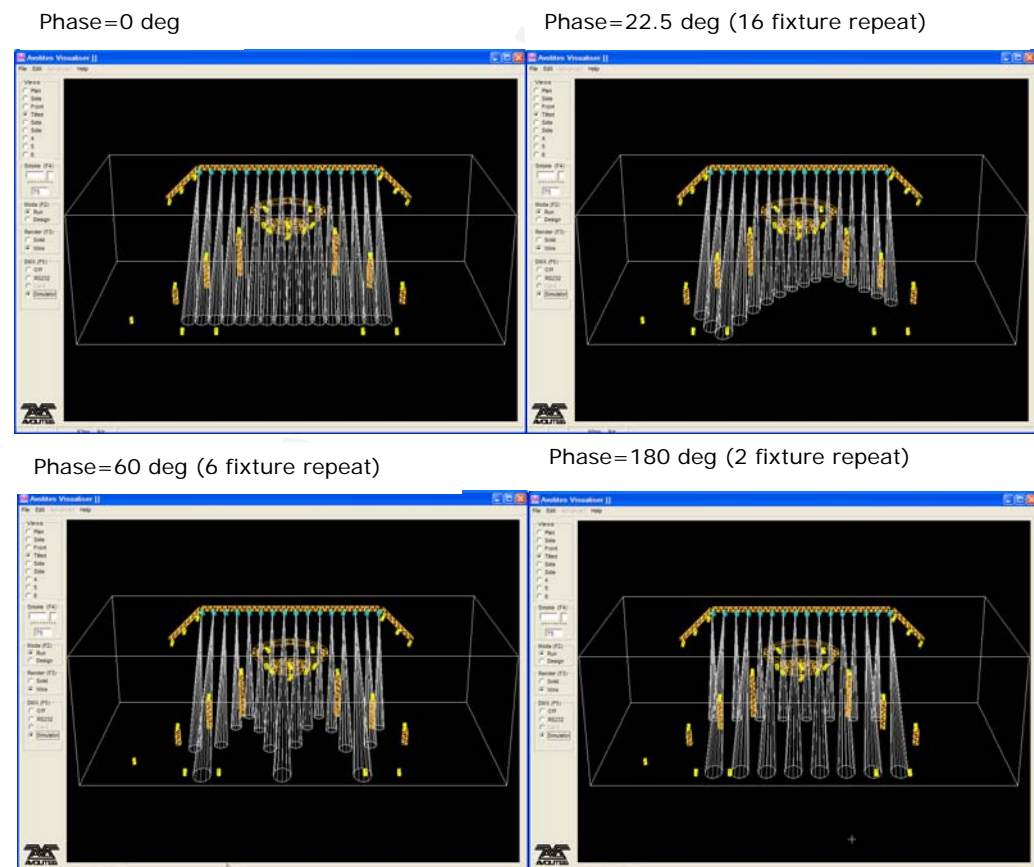

The display above Wheel 6 shows the phase in degrees, and below that, the number of fixtures before the shape repeats. For example, 180 degrees repeats every 2 fixtures, 90 degrees repeats every 4 fixtures, 60 degrees repeats every 6 fixtures, and so on.

### 5.1.4 Changing the initial offset phase of a shape

If you are running multiples of the same shape, you might not want them all to start off in phase with each other. The Initial Offset option allows you to set where the shape will start, for example if you want to start the shape half way through its cycle, you would set the Initial Offset to 180 degrees.

The Initial Offset setting is set by Wheel 4 on the second page of the Shape Properties; press the Soft Key button again to show it. The Soft Key button flashes to indicate that there is a second page of options.

## 5.2 Edit

### 5.2.1 Editing shapes which are running

If more than one shape is running, you can select which one is connected to the control wheels using Shape option B [Edit].

- 
- 1> *If you are not in the Shape menu, press the Shape button.*
  - 2> *Press B [Edit].*
  - 3> *Above the softkeys is a list of the currently running shapes.*
  - 4> *Press a softkey to make the shape active. The active shape is highlighted. The Preset handle displays clear to show only the fixtures in that shape.*
  - 5> *You can select or deselect fixtures so that your changes only affect some of the fixtures in the shape. All fixtures are selected by default.*
  - 6> *Press Up when you have finished.*
- 

- If you applied the same shape several times to different fixtures, you can change each copy of the shape independently.

- If you are editing shapes being played back from a cue, chase or cue list, the shape name on the softkey list also shows the playback legend (in the screen shown the shape name is "Diamond" and the playback name is "Bally Hoo").

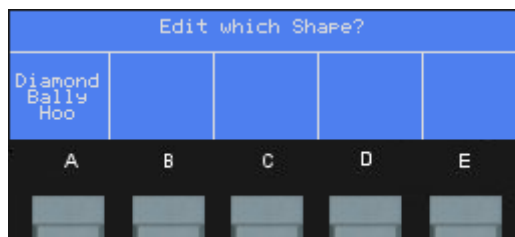

Make sure that you edit the shape from the playback you are working on, otherwise when you record the playback you will record another shape into it.

### 5.2.2 Changing the order of fixtures in the shape

You can change the order in which a shape is applied to fixtures. This order is normally set by the order in which you selected the fixtures when you created the shape.

- 1> *If you are not in the Shape menu, press the Shape button.*
- 2> *Press D [Set Fixture Order]*
- 3> *Select a shape to edit from the softkeys.*
- 4> *The preset/handle LCDs will clear to show only the fixtures in that shape. The bottom number on the handle display indicates their order in the shape.*
- 5> *Press a preset swap button for a fixture to set its order in a shape. You can enter a new starting number on the keypad or press the backspace button to remove entered numbers. The current number is shown on the display above softkeys F-J.*

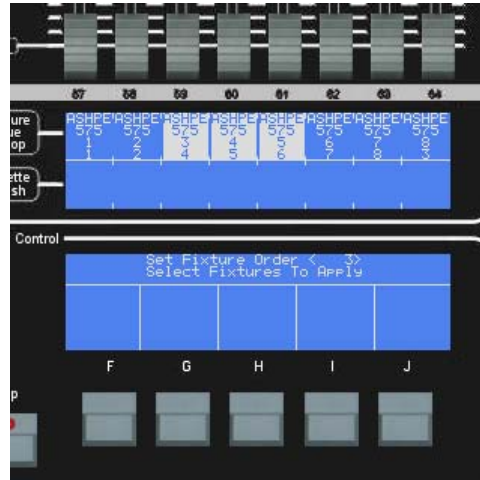

### 5.2.3 Reversing a shape

You can reverse the direction of a shape by pressing E [Reverse] from the shape menu, then pressing the softkey for the shape you want to reverse.

## 5.3 Delete

### 5.3.1 Deleting shapes

You can delete a running shape by pressing C [Delete] from the shape menu, then pressing the softkey for the shape you want to delete.

## 5.4 Advanced options

### 5.4.1 Shape fade mode

When a shape is stored in a cue, you can set how the shape fades in using the cue's Mode setting.

Modes 0 and 3: The shape size will grow from zero to the programmed size using the time/delay settings of the cue.

Modes 1 and 2: The shape size will be set by the fader position. It will start at zero and grow to its programmed size when the fader reaches 100%.

If a new cue is fired which controls the same attributes (for example, a second shape controlling the same fixtures as a currently running shape), the new shape will crossfade from the running shape.

### 5.4.2 Shape LTP rules

- When using shows created in an old version of software, operators need to be aware that shapes may run differently in this software release

Shapes are treated as an LTP feature of the moving light that they is running on (in earlier versions of the software this was not the case).

When recording a shape, the shape will now continue to run in subsequent steps until it is changed to a different value, just like Pan & Tilt, Colour etc. (Previously the shape would stop when you had saved a step and you would have to create it again for the next step). You can stop a shape by recording a zero size and speed for the shape.

If you are loading a showfile from an older version of the software, you will need to ensure that any shapes that are run (in cue lists for example) are cancelled in a later step.

Copyright Avolites Limited



## 6. Cues

*This chapter contains: HTP and LTP channels; how the Diamond works when programming; recording a cue; playing back a cue; changing playback pages; setting fade times for a cue; copying and deleting cues; the include function; editing cues; the "off" button; blind mode; using shapes in cues.*

The Diamond has many functions for producing a complex light show, and the most fundamental part is a Cue, in which you can store a "look" you have created using your lights.

Cues are stored on the playback faders across the near edge of the console. You can also store cues on the Preset faders if you want to. You can have as many pages of cues as you want, the pages are selected using the Page-1 and Page+1 buttons to the right of the playback faders.



Playback faders

The cue functions on the Diamond are very powerful; the first part of this section explains the basics of how the Diamond uses cues.

### 6.1 Create

#### 6.1.1 How the Diamond works when programming

When you select one or more dimmers or fixtures for control, they are loaded into the Editor. You can then use the wheels, palettes and the @ button to change the settings on the fixture. You can also apply shapes to it.

If a fixture is selected after you have changed some attributes then the current list of fixtures is emptied and a new list is started. The previous list of fixtures is stored in a "Selection Group". You can go back through previous Selection Groups using Shift and the ← → buttons to the right of wheel 3.

All fixtures and attributes that have been edited since the last Clear are stored in the Programmer. The order in which you selected the fixtures is also stored, and is used with the Fixture Overlap function. When you record a cue, the contents of the Programmer are saved into the cue using the Record Mode as described below. The attributes you have changed are shown using the IPCGBES letters in the display above the wheels. If you are recording using a mask or by channel (see next page) a second group of IPCGBES letters will be shown below the first to tell you which attributes are going to be recorded.

Fixture Bank 0		IPCGBES	
Palette Bank 0			
Cyan 5.0%	Magenta 29.1%	Yellow	
Dimmer 2.27%	Pan	Tilt	

When you press Clear (by the numeric keypad), the programmer and editor are emptied. This makes sure you don't record fixtures you don't

want. You also need to press Clear when you finish programming, because any attributes in the programmer will override playbacks.

You can deselect all fixtures (remove them from the Editor but leave changes in the Programmer) by pressing Shift+All (between the arrow buttons). To select all fixtures in the Programmer into the Editor press All without Shift.

Fixtures which are in the programmer are shown in light blue on the VDU Stage View. Attributes in the programmer (the things you have changed) are shown in cyan on the VDU Stage View screen. Also, fixtures which are in the programmer have their numbers inverted on the LCD screens. (In this picture, Macs 7-11 are in the programmer and 10 & 11 are currently selected).

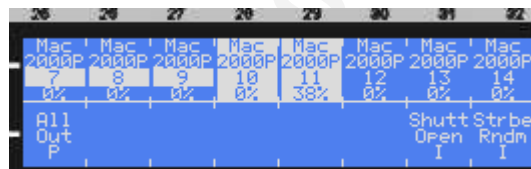

The Diamond has four Record Modes which are selected on softkeys G-J when you save a cue:

- I [Record by fixture]: This is the normal mode of the Diamond. When you record a cue, all attributes of every fixture in the programmer are recorded in the cue. So if you change only the position of a fixture, the colour, gobo, intensity and all other attributes of that fixture are recorded as well (fixtures are put in the programmer when you select them, you don't have to change anything). This is useful because you know that when you recall the cue it will look exactly as it did when you saved it. However, it can be slightly inflexible if you want to combine cues. You can also use this mode to copy some fixtures to another cue; fire the cue, select the fixtures you want, then save to a new cue.
- H [Record by channel]: Only attributes you have changed are recorded in the cue; for example if you change the position of a fixture, only the position is recorded. When you recall the cue, the colour, gobo etc will remain as they were last set. This means you can use a cue to change the position of some fixtures while leaving the colour set by a previous cue, allowing more variety when you are running a show. It is a powerful feature but you can easily get yourself into trouble with it so you need to be sure which attributes you want to record and which you want to "show through". It is best to record some cues using Record by fixture which set the fixtures to a known state, then have some colour cues to modify just the colour, or some gobo cues to set the gobo, or other attributes.
- G [Record by Mask]: You can select which attributes from changed fixtures will be recorded in the cue, using the IPCGBES attribute groups. Above Softkey G the display shows you which attributes are going to be saved. Press G again to change which attributes will be recorded.
- J [Record Stage]: The Diamond will record all fixtures or dimmers which are either in the programmer, or which are lit (have intensity above zero). In Cue List recording this mode is called [Record Stage Hard Cue]. Note that the cue will contain the output values of the fixtures; palettes are not saved when using Record Stage. If you update a cue, palettes in



the cue will be overwritten with absolute values.

Firing a cue does not place the values from the cue in the programmer (although the Include function lets you do this, see section 6.3.2 on page 164). Also, if you use record by channel mode, the changes made by the Locate function will not be stored in cues you save.

### 6.1.2 Creating a cue

- 1> Press Clear to clear the programmer. This ensures that you are starting with a clean slate.
- 2> Set up the look using the fixtures. You can include shapes in a cue. Remember that only the fixtures you have selected will be included in the cue.
- 3> Press Rec Cue.
- 4> Select the Record mode using softkeys G-J.
- 5> Press the Go/Swop button of an empty Playback to record the cue. (Select a new page first if you want to use a different page).
- 6> Press Clear to clear the programmer. Repeat from 2 to program more cues.



Rec Cue button

Other useful things to know about recording cues:

- If you are recording a lot of cues, you can press E [Press to latch menu] to keep the Rec Cue menu active. Press Exit to leave Rec Cue mode.
- To record a cue onto a preset fader, press a Preset Select button instead of a playback Swop button.
- The display above the fader shows a legend for each cue. You can change this to help you remember what's in it. Press Set Legend, then the playback Go/Swop button (or the preset Select button), then enter a legend on the keyboard. Your typing is shown above the fader and above softkey C so you can see what it is going to look like (there are 2 rows of 6 letters). Press Enter to store it.
- You can also legend the current playback page this way, by pressing A [Set Page Legend] instead of the playback Swop. The page legend is displayed above the Chase controllers.

### 6.1.3 Using shapes in cues

As you would expect, any shapes you have set up will be saved as part of the cue.

You can create a cue which contains a shape with no base reference values; a shape cue like this can then be overlaid on other cues to give you instant effects based around the settings in that cue. When recording the cue, use Record By Mask mode and ensure that all attributes other than the Shape option are excluded from the cue.

## 6.2 Playback

Because it's possible to play back a large number of cues at the same time, the Diamond has to have rules on how it combines the output from different cues. These are called HTP and LTP rules.

### 6.2.1 HTP and LTP

The Diamond treats control channels in two ways:

- Dimmer or intensity channels work on the principle of "Highest Takes Precedence" (HTP). If an HTP channel is active at different levels in several cues, the highest level will be output. When you fade out a cue, the HTP channels fade out with it.
- All other channels work on the principle of "Latest Takes Precedence" (LTP). The latest change takes over from any other values, so the most recent cue to be turned on is the one which is output. When you fade out a cue, LTP channels retain their values until changed by another cue.

### 6.2.2 Playing back a cue

To fire (play back) a cue, raise the fader. (Make sure there are no values in the programmer by pressing the Clear button, because anything in the programmer will override the playback).

- You can fire several cues at once.
- The HTP levels in the cue will be mastered by the fader level; for example if you set the fader at 50% then all HTP levels will be 50% of their programmed values.
- LTP channels are triggered as soon as the fader passes 3% (you can set the point at which this occurs on the User Settings menu). If a fade time is programmed the LTP channels will start to fade; if there is no fade time they will snap to position (unless the cue is set to Mode 2; see the timings section 0 on page 167 for details of modes).
- You can Flash the cue by pressing the grey flash button. You can Swop (solo) the cue by pressing the blue Swop button (all other active cues will turn off while the button is pressed).
- You can pre-position the LTP channels in the cue before raising the fader by pressing the Pause & Preload button. Fixtures which are currently not lit (intensity at 0%) will move to their programmed positions. This is useful if you want to avoid the fixture "swinging" into position when you turn the playback on.
- You can set a Preload fade time the same as a palette fade time. Enter a time at the main menu then press the Preload button of the playback, the fixtures will fade to the preload position.
- If you need to quickly kill the cue, press Off then softkey F (see

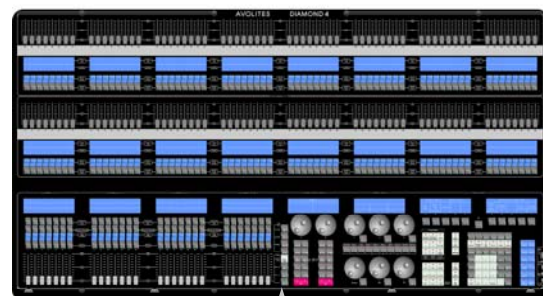

Playback page buttons

section 6.3.5 on page 166).

- If you need to quickly kill all playbacks, press Off then softkey G (see section 6.3.5 on page 166). To reactivate playbacks you have to take the faders to 0 and put them back up again.

### 6.2.3 Changing playback pages

You can change playback pages using the Page-1 and Page+1 buttons to the right of the playback faders. You can directly jump to a page by pressing the Go Page button. All pages you have created are shown on the softkeys for instant selection, or you can type the page number on the numeric keys, and press Enter.

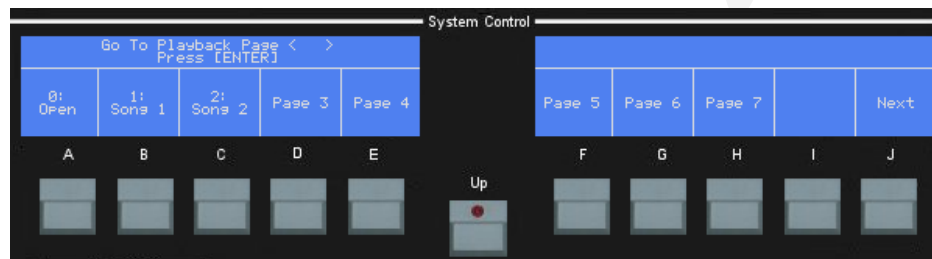

If you have stored cues on the preset faders, you select different pages of preset faders using the Fixture Bank buttons below Softkey A.

The current playback page number (and legend, if you've set one) is displayed on the top line of the Chase Controller display.

- Playbacks which are fired when you change page remain active. This is called a "heldover" playback. The display above the fader shows the name of the active cue in the middle row, and the name of the cue from the new page in the top row. An arrow indicates if the heldover playback is from a page above (up arrow) or a page below (down arrow).

Cue from new page  
Running cue from previous page



- If you want to fire a cue on a fader which is already on from a previous page, lower the fader to zero then raise it again. The cue from the previous page will stop and the cue from the new page will fire.
- You can lock a playback so it will always appear in the same position on every page. Press J [Utils], then B [Lock Playback] and select the playbacks you want to lock. A padlock icon is shown above the playback.
- You can legend the current playback page by pressing Set Legend, then A [Set Page Legend], then entering a legend using the keyboard. The page legend is shown at the top of the display above the chase control wheels.
- You can create a shortcut on a Palette button which will set up a particular playback page, fixture page and palette page. See



section 9.1.6 on page 199.

## 6.3 Edit

### 6.3.1 Editing a cue

You can edit any part of a cue you have already saved simply by making the changes and saving the new information on top of the cue.

- 
- 1> *Press Clear to empty the programmer.*
  - 2> *Fire the cue you want to edit, so you can see what you are doing. Kill all other cues to avoid confusion.*
  - 3> *Select the fixtures you want to change, and make the changes.*
  - 4> *Press Rec Cue.*
  - 5> *Press the Go/Swop button for the cue you are editing.*
  - 6> *The Diamond will merge the existing cue with your changes. Unchanged information is not affected.*
- 

- If you are in "Record by fixture" mode, all attributes of any fixture you've changed will be updated in the cue with their current settings. If you only want to update certain attributes of a fixture, you need to use "Record by channel" or "Record by mask" mode to only save those attributes.
- If you want to overwrite the cue entirely, you need to delete the old cue first (press the blue Delete button, then press the Go/Swop button twice)
- If you want to edit a shape within a cue, when you select the Shape Edit function (see section 5.2.1 on page 156) you will see the cue legend below one of the shapes. Make sure this is the shape you edit, otherwise you will save another shape into the cue when you record it.
- If you edit a cue using Record Stage mode, palettes will not be stored. If you update a fixture which was using a palette, the palette will be removed and replaced with absolute values.

### 6.3.2 The Include function

The Include function lets you load selected parts of a cue back into the programmer. (Normally, only manual changes to fixtures are put in the programmer). You can then use this to make a new cue. This is useful if you want to make a cue which is similar to one you already have, or to build a new cue from various parts of other cues.

When you use Include, you specify which attributes of which fixtures you want to load into the programmer. So, for example, if you have a cue which contains position, colour and gobo information for 8 fixtures, you can use the include function to load only the colour information for 4 of the fixtures into the programmer. You could then "Include" position information from another cue into the programmer, and build up a new cue using information from several existing cues.

- 
- 1> *Press Include (below softkey D).*
  - 2> *Press the Go/Swop button of the cue you want to include.*
  - 3> *All fixtures in the cue will be selected. If you don't want them all, deselect the fixtures you don't want.*
  - 4> *Use the softkeys to select which Attributes you want to include*

(All are included by default). Softkey H lets you include or exclude Shapes from the cue.

- 5> Press Enter. The selected attributes of the selected fixtures will be loaded into the programmer.
- 6> Repeat from 2 to include other attributes from the same fixtures, or repeat from 1 to include other fixtures.

- If you want to put the whole cue into the programmer, ensure all Attributes are selected in step 4 (press I [Select All]). Everything will be placed in the programmer.

### 6.3.3 Removing attributes from cues using "Off"

The "Off" button allows you to remove an attribute which has been stored in a cue, as if you never recorded it.

For example, suppose you recorded a cue which had scans at a certain position, with the colour set to green. If you later decide that you don't want a colour recorded at all in the cue, so that the colour set by previous playbacks will remain, you use the Off function to turn off the colour in the cue. You can also use the Off function to remove complete fixtures from a cue by selecting all the attributes.

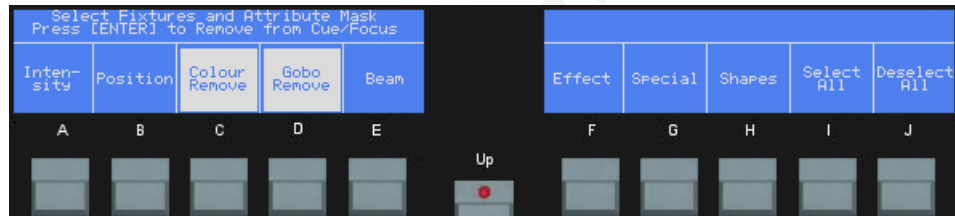

Setting an attribute to Off is not the same as recording an attribute at zero, since this would change the attribute when the cue was fired. It is the same as excluding that attribute using the mask when recording, and the attribute will remain unchanged when the cue is fired.

- 1> Press the OFF button (left of the numeric keys) to display the Off menu.
- 2> Press the Go/Swop button of the cue you want to change.
- 3> All fixtures in the cue will be selected. If you don't want to change them all, deselect the fixtures you don't want.
- 4> Use the softkeys to select which Attributes you want to remove. Softkey H lets you remove Shapes from the cue.
- 5> Press Enter to remove the selected attributes of the selected fixtures from the cue.

- Attributes marked as "Off" are not deleted from the cue, they are just disabled. You can reinstate the recorded values using the On function as described below.
- You can also use this function to turn off fixtures or attributes in a palette. Use the procedure above, but press a palette select button instead of a cue Go/Swop button.

### 6.3.4 Reinstating attributes to cues using "On"

This allows you to reinstate an attribute which has been switched off.

In addition, when the Diamond records a cue, it actually records not just the programmer or masked settings, but the entire console output. Anything not in the programmer is marked as "Off" but the information

is still recorded.

This means that you can go back to a cue and make it include fixture settings which were not saved originally. This is handy if you save a cue using the wrong Record Mask settings.

- 
- 1> *Press Shift and OFF to display the ON menu.*
  - 2> *Press the Go/Swap button of the cue you want to change.*
  - 3> *All patched fixtures and dimmers will be selected. If you don't want to change them all, deselect the ones you don't want.*
  - 4> *Use the softkeys to select which Attributes you want to re-enable.*
  - 5> *Press Enter to reinstate the selected attributes of the selected fixtures back into the cue.*
- 

### 6.3.5 Other "Off" functions

Press Off (left of numeric keypad) to access the Off menu.

F [Stop Playback] (followed by a playback Swap button) kills a playback instantly. The playback fader has to be pulled down to zero and put up again to restart the playback.

G [Stop all active playbacks] is the same as pulling down all the playback faders to zero.

I [Remove fixtures from program] removes selected fixtures from the programmer (so if you save a cue, they won't be included)

J [Remove group from program] allows you to remove a group of fixtures from the programmer. Select this option then press the Palette/Flash button for the group of fixtures to be removed.

## 6.4 Copy

### 6.4.1 Copying a cue

Copying a cue is very simple on the Diamond. Copies are normally independent of each other, not linked; you can create a linked copy (where any changes to the cue will also affect the copied cue) by pressing the Flash button instead of the Go/Swap button.

- 
- 1> *Press the blue Copy button (bottom right).*
  - 2> *To create an independent copy, press the Go/Swap button of the playback you want to copy. To create a linked copy, press the Flash button of the playback.*
  - 3> *Press the Go/Swap button of the playback where you want to store the copy.*
- 

Press E [Press to latch menu] to keep the copy mode active. You can keep copying using steps 2 and 3 without having to keep pressing the Copy button. Press Up to leave latched copy mode.

Press B [Press to Include Legend] to set whether or not the legend is copied with the cue.

You can copy a range of cues (or other items) by holding down the first button of the range, then pressing the final button. When you select the button to store the copies, you must make sure that there are enough free playbacks to fit in all of the items you've copied, or the copy will fail.

## 6.5 Delete

### 6.5.1 Deleting a cue

To delete a cue:

- 
- 1> *Press the blue Delete button (bottom right).*
  - 2> *Press the Go/Swap button of the cue you want to delete.*
  - 3> *Press the Go/Swap button again to confirm the delete.*
- 

Press E [Press to latch menu] to keep the delete mode active. You can keep deleting using steps 2 and 3 without having to keep pressing the Delete button. Press Up to leave latched delete mode.

You can delete a range of cues (or other items) by holding the button at the start of the range and then pressing the button at the end of the range. Then press A [Delete].

## 6.6 Moving

### 6.6.1 Moving a cue

To move a cue to a different playback fader:

- 
- 1> *Press the blue Move button (bottom right of console).*
  - 2> *Press the Go/Swap button of the cue to be Moved.*
  - 3> *Press the Go/Swap button of the playback (or the Select/Swap button of the preset fader) you want to Move it to.*
  - 4> *E [Press to latch menu] keeps the Move mode active, so you can keep Moving things without having to keep pressing the Move button. Press Up to leave Move mode.*
- 

## 6.7 Timing

The Diamond allows a wide variety of timing functions to be set.

### 6.7.1 Setting fade times and Overlap for a cue

You can set a delay, fade in and fade out time independently for every cue. Shapes in the cue will also be affected, depending on the fade mode.

You can delay the fade times between fixtures in a cue so that the cue is applied sequentially to each fixture. This is called Fixture Overlap and can create some amazing "peel off" or "roll" type effects with no programming at all.

In the diagram below, the top picture shows how the LTP channels change when used with delay, fade and fade out times. The second picture shows how the HTP channels change. The third and fourth pictures show what happens to the LTP channels when fixture overlap and attribute fade are used.



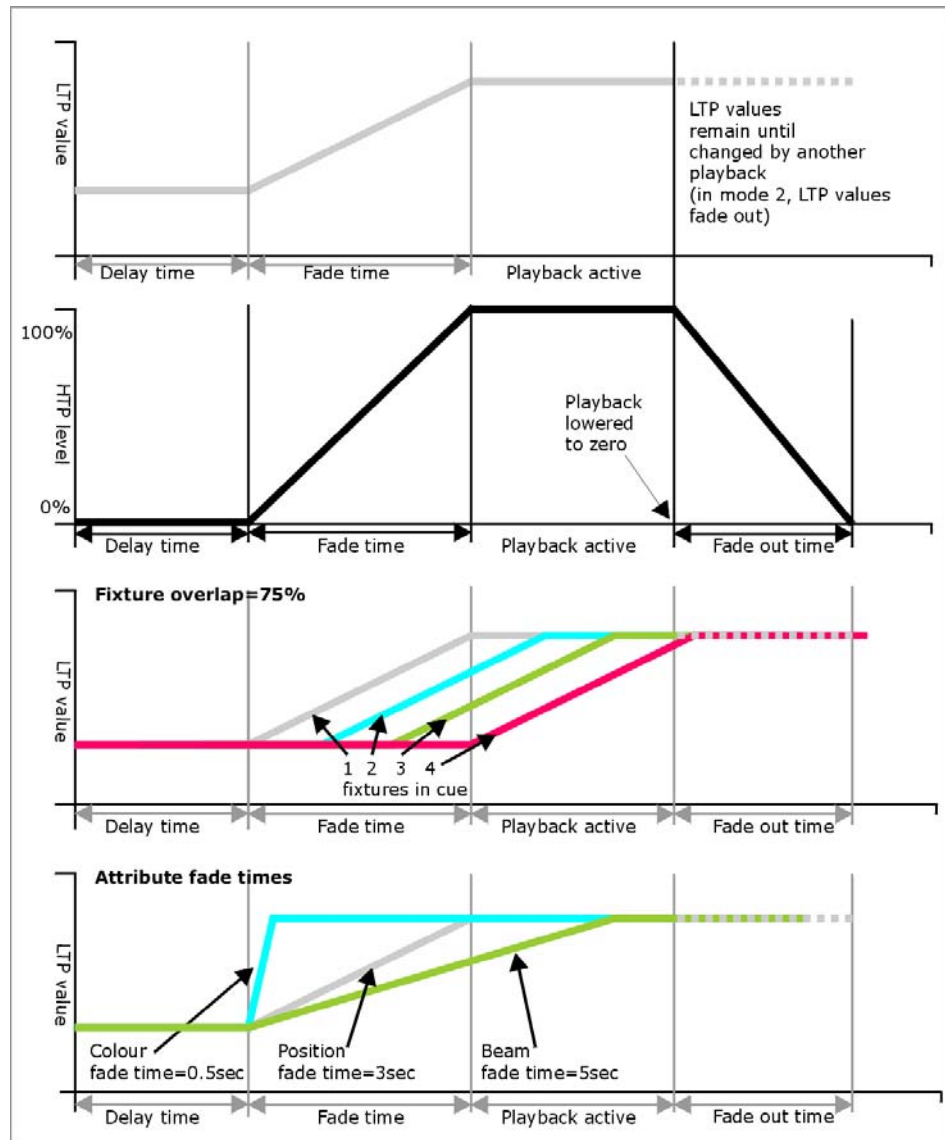

The times are set like this:

- 1> Press A [Set Times] at the top level menu.
- 2> Press the Go/Swap button of the cue.
- 3> Press A [Mode x] to set the cue mode. This sets how the times are used, see below.
- 4> Press B [Delay time] to set the delay before the cue starts, C [Fade time] to set the fade-in time of the cue, and D [Fade out time] to set the fade-out time of the cue.
- 5> Type the new time (in seconds) using the numeric keypad and press Enter to save it.
- 6> Press E [Fixture Overlap] to change the overlap, then enter 0-100 on the keypad. 100% means all fixtures fade together. 0% means that the first fixture will finish its fade before the next one starts. 50% means that the 2<sup>nd</sup> fixture will start fading when the first one is half way through its fade. The order of the fixtures is set by the order you selected them, or use option H to change order.
- 7> Press Up to get out of Set Times mode.

- You can also set independent times for the IPCGBES attribute groups, and for each individual attribute, see next section for



details of this.

- H [Set Fixture Order] allows you to change the order of fixtures when using Overlap (Normally the order is set by the order in which you select the fixtures). The display below the fixture presets changes to show the order on the bottom line (in the display on the right the order has been set to 8 7 6 5 4 3 2 1). You can reorder the fixtures by typing the start number on the numeric keys, then pressing the Select buttons in the order you want them. For example, to set the order of 8 fixtures, press 1 on the keypad, then press the Select button of the fixture to be first, then the Select button for the second, and so on. You can set multiple fixtures to the same position in the sequence, or set them to 0 to exclude them from the overlap effect. Press Up to finish setting the fixture order.
- J [Playback options] allows you to select a different Fade Curve. Press A [Curve] then select a different curve from the softkeys. See section 11.4 on page 218 for a description of the different curves available.

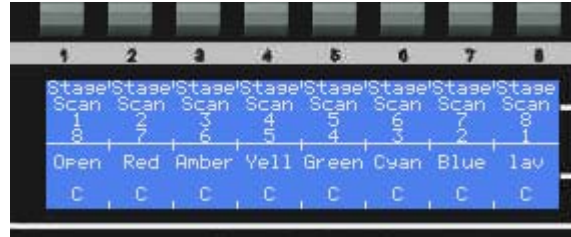

The times you enter are affected by the cue mode:

- Mode 0 – Channels will fade in as set by the fade time. The Fade Out time is ignored. If times are set to zero, the HTP channels fade in with the 0-100% position of the playback fader and the LTP channels will snap.
- Mode 1 - Channels fade in as set by the fade time. HTP channels fade out as set by the fade out times (LTP channels remain as set in the cue). If times are set to zero, the HTP levels will fade in and out with the fader and the LTP channels will snap when the cue is fired.
- Mode 2 – Channels will fade in as set by the fade time. The Fade Out time is ignored. However, the fade will stop when the fader position is reached, so if the fader is set to 50%, the attributes will stop half way to their programmed position. You can reverse the fade back to the original position by moving the fader back. If times are set to zero, both HTP and LTP channels are controlled by the fader position. In this mode LTP channels revert to their previous settings when the cue is deactivated.
- Mode 3 - Crossfade cue. All channels, including intensity channels, will fade to the settings in the new cue. All other cues fade out and all other active playbacks become inactive; if you need to re-fire a playback, take the fader to zero and put it up again.
- If the cue includes shapes, then the shape will change with fade times. The changes will be timed for a Mode 1 cue and controlled by the fader position for a Mode 2 cue. This allows you to create a shape which gets bigger or faster as you push up the fader.

When a cue is stored on a playback handle (rather than a preset

handle) the Mode of the cue is shown on the display next to the legend.



### 6.7.2 Setting attribute fade times for a cue

You can set individual fade times for each attribute group (such as Position), or for each attribute (such as Pan). If you set a time, it overrides the normal times.

To set an attribute group fade time:

- 
- 1> Press A [Set Times] at the top level menu.
  - 2> Press the Go/Swap button of the cue to be changed.
  - 3> Press F [Set IPCGBES times].
  - 4> Select the Attribute groups for which you want to change the timing. H [All] selects all of them.
  - 5> All fixtures in the cue will be selected for changing. If you don't want to change the times for some fixtures, deselect them now.
  - 6> Press A [Set delay] to set delay time, B [Set fade] to set fade time or E [Clear times] to delete the attribute times and go back to the normal times.
  - 7> Type the new time using the numeric keypad and press Enter to save it, or press A [Clear] to clear that individual time.
  - 8> Press Enter to save the changes.
- 

If you don't want to change all attributes in a group, for example you just want to change the Pan time but leave the Tilt time as default, use option G [Set Attribute Times] in step 3, then select the individual attributes you want in step 4.

## 6.8 Advanced options

### 6.8.1 Playback Options

You can enter the playback options menu by doing the following

- 
- 1> Press Softkey B "Playback Options".
  - 2> Press the blue Swap key for the playback you wish to edit.
- 

Or by

- 
- 1> Connect a list or chase to a controller.
  - 2> Press the 'Options' key on the controller panel.
- 

This menu presents you with the following options:

- A [Release Settings]
  - A [Freeze all attributes] The Fixtures LTP channels will stay in the same position when the playback is Killed.
  - B [Release all attributes] All LTP attributes will return to the Power On position with the dimmer turned off. (The position they were in when initially patched)
  - C [Release all but pan/tilt] Pan and Tilt will stay in position, all other LTP attributes will return to the Power On position.
- B [Shape Size: Fader] If the cue is a shape then the size of the shape will be defined by this option.

- C [Shape Speed:Fader] If the cue is a shape then the speed of the shape will be defined by this option.
- D [Curve = Linear] This options defines the type of curve associated with that particular cue.

### 6.8.2 Recording in Blind mode

The Diamond has a useful function called "Blind mode", which allows you to program cues without altering the output of the console. The contents of the Programmer are saved on entering Blind mode, and restored when you leave Blind mode. Any playbacks turned on continue as normal, and you can make any changes you like without affecting the output. The changes you are making can be viewed on the internal Visualiser system so you can see what you are doing.

This is useful if for some reason you need to edit a cue in the middle of a show without upsetting the current state.

Turn Blind mode on and off using the Blind button to the top right of the numeric keys.

- If you have edited a playback which was already turned on when you entered Blind mode, when you leave Blind mode you will need to turn the playback off then on again to load the new version.

### 6.8.3 Firing a cue by MIDI

The Diamond can receive MIDI notes, allowing the console to be controlled by an external MIDI device.

To set up a cue to be fired by a MIDI note:

- 
- 1> *Press the blue Setup button.*
  - 2> *Press H [Midi Options]*
  - 3> *Press E [Assign Fader Notes].*
  - 4> *The display above softkeys A-E shows "Press a swop to set < 0 >". The 0 is the MIDI note number which will be allocated, you can change this by typing a different number (up to 127) on the numeric keypad.*
  - 5> *Press a Swop button to allocate that playback to the specified MIDI note. The playback can be a cue, chase, or cue list.*
  - 6> *You can continue to allocate cues to MIDI notes by pressing more swop buttons. The MIDI note number automatically increases every time you press a swop.*
  - 7> *Press Up when you have finished.*
- 

- You can set the MIDI receive channel using B [Channel]. The Diamond numbers its MIDI channels 0-15 rather than the usual 1-16, so you must subtract 1 from your desired MIDI channel (i.e. MIDI channel 1 is set as 0 on the Diamond).
- D [Reset] removes all MIDI note allocations.
- A [Disable MIDI In] turns off the MIDI functions. Press A again to turn MIDI back on.
- If you have complex playback requirements (for example, you need to sequence a complete show), then it's better to use MIDI timecode to step through a list of cues. See section 10 on page 203.

- The D4 cannot reliably control a Pearl console using MIDI.

Copyright Avolites Limited 2010

## 7. Chases

*This chapter contains: Programming a chase; running a chase; setting speed, crossfade and direction; manually controlling the chase steps; setting step times and unlinking; editing a chase using unfold; editing a chase which is running; copying chases; chase options.*

As well as being used to store static cues, the playback faders on the Diamond can also be used to store chases (sequences of cues). You can also store chases on the preset faders.

Chases can run once or repeat continuously. You can set individual fade time for each cue in the chase and unlink cues so that the console waits for you to press Go before the chase continues.

### 7.1 Create

#### 7.1.1 Programming a chase

To program a chase, you have to set up the look for each cue in the chase, then save it. You can select record by fixture, by channel, by mask or record stage as with cues.

You can either set all the fixtures and dimmers manually for each cue in the chase, or you can use Include to load in the information from cues you have already recorded.

You can also use "Record Stage" mode to save an existing cue in a chase, just by turning it on.

1> Press the Rec Chase button (below softkey D).

2> Press the Go/Swop button of the playback or the Select/Swop button of the preset where you want to store the chase.

3> Select the Record Mode of the console: by Fixture, Channel, Mask or Stage using softkeys G-J. See section 6.1.1 on page 159 for a description of these modes.

4> Set up the look for the first cue, either manually or by using "Include" on existing cues.

5> Press the Go/Swop button of the playback or A [Append Cue] to store the programmer contents as Cue 1 of the chase.

6> Press Clear (unless you want to re-use the contents of the programmer), then repeat from step 4.

7> Press E [Exit] to finish when you have stored all the cues you want.



Rec Chase button

- If you get a cue wrong, you can change it by pressing C [Insert Cue], then entering the cue number you want to change. The existing cue will be overwritten. You can also insert a new step by entering a step number in between two steps, for example to

insert a cue between cues 2 and 3, use cue number 2.5.

- The cue number currently being saved is displayed above Softkey A, and the total number of cues is shown on the top line of the display.
- Press Clear when you have finished recording the chase, otherwise when you try to play it back the programmer will override the chase and you won't see the chase properly.
- You can record shapes in a chase. If the same shape is saved in subsequent cues it will continue from step to step and if not it will stop at the end of the cue. (The Diamond considers the shape to be the same if you didn't press Clear after the previous step, and didn't change the speed, size or phase of the shape from the previous step; or if you Included the shape from the previous step and have not modified it)
- You can set a legend for the chase by pressing Set Legend, then pressing the Swop button for the chase and entering the legend, as with cues.
- There is no limit to the number of steps in a chase.

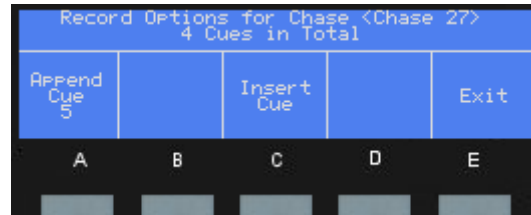

## 7.2 Playback

### 7.2.1 Playing back a chase

To fire a chase, raise the fader of the playback. (You can also use the Flash/Swop buttons). The chase will start to run.

- The HTP (intensity) channels in the chase will be controlled by the fader; if fade times are programmed, the fade will stop at the fader level. The other channels (LTP) will be set as soon as the fader moves above zero according to the fade times programmed in the chase. You can set the point at which the LTP channels activate from the User settings menu.
- While the chase is running, press the Connect/View button of the playback to open a window showing details of the chase steps on the VDU screen (this screen is described in the Timings section 8.7.4 on page 193).
- You can preload the first step of the chase (which will pre-position all fixtures to the first step) by pressing the Pause & Preload button of the playback.
- You can temporarily pause the chase by pressing the Pause & Preload button of the playback while it is running. Press Go/Swop to resume playback (see section 7.2.4).
- If the chase is stored on a playback handle (rather than a preset) the display above the fader shows the live and next cue legends (or numbers) as shown on the right. The live cue is on the bottom line and the next cue on the top line. The speed of the chase is also shown and its direction (F-Forward, R-Reverse, B-Bounce and X-Random).



- If you need to quickly kill all playbacks, press Off then G (see section 6.3.5 on page 166). To reactivate playbacks you have to take the faders to 0 and put them back up again.

There are many options you can set to determine the way the chase runs and these are described in the rest of this chapter.

### 7.2.2 Connecting a chase to a Controller

The Diamond has two identical controllers (A and B) for controlling chases and cue lists.

When you fire a chase, chase controller A is automatically connected to it. If you fire a second chase, controller A is connected to the newer chase.

- You can connect a different chase to either controller by pressing the Connect button (below the wheels) then the Connect/View button above the chase you want to control.
- The display above the controller shows the chase name, speed, current cue number and % progress of fades (WFG means "Waiting for Go")
- Disconnect a chase from the controller by double pressing the controller's Connect button.
- You can turn off the "chase autoconnect" option in the User Settings menu if you don't want to connect to a chase when you fire it. You will have to use the Connect button to control the chase if you do this.



Chase controllers

### 7.2.3 Setting speed and crossfade for a Chase

The controller wheel is assigned to control the Speed of the chase it is connected to. You can also enter a speed from the keypad. The last speed you set on the wheel is always remembered, you do not have to tell the Diamond to save it.

Crossfade is the "slope" between cues; with a crossfade of 0, the fixtures snap instantly to the next cue, but with a crossfade of 100, the fixtures spend the whole cue time fading to the next cue. With a crossfade of 50, the fixtures delay for half the cue time and fade for the other half of the time.



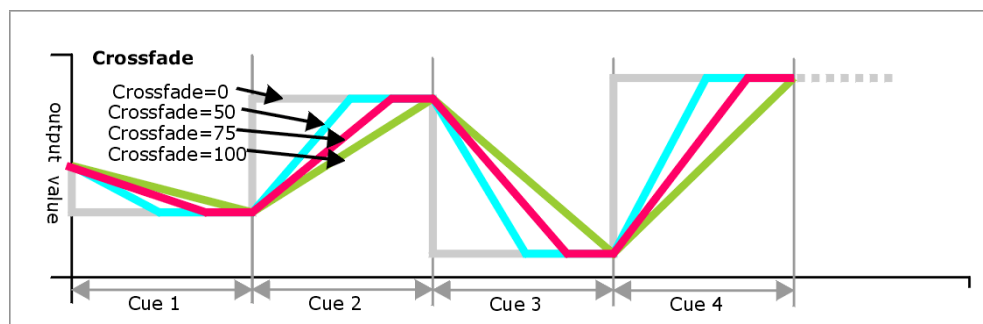

You set the crossfade and speed as follows:

- 1> Press A [Set Times] from the top level menu then the Go/Swap button of the chase.
- 2> To set the crossfade, press B [Xfade] and type the fade from 0 – 100. 0=no fade (the chase will “snap”), 100=max fade (the chase will move continuously from step to step).
- 3> To set the speed, press C [Speed], type the new speed, then press Enter. The speed can be set in Beats Per Minute (BPM) or seconds depending on the User Settings. Keep pressing the C button repeatedly in time with the music to set the speed to match the music.

**Note:** It is also possible to set the speed of a running chase by double tapping the go button on the chase controller (maximum time 20 seconds).

There are other options you can set for the chase from this menu including Cue and Fixture Overlap, which are described in the Timings section 7.7.1 on page 180, and Chase Direction, Bounce, Loop and Random which are described in the Advanced Options section 7.8.1 on page 183.

You can set individual times for each cue in a chase and unlink cues from each other so they wait for you to press the Go button. This is done using the Unfold function which is described in section 7.3.2 on page 177.

#### 7.2.4 Manually controlling the steps of a chase

You can take manual control over a chase by pressing the Pause & Preload button. (If the chase is connected to a controller, you can press the Pause button on the controller)

Press the Go/Swap button, or the red Go button of the controller to resume playback of the chase.

While paused, you can press the Pause button again to jump to the next step.

To set the “next” step to be a particular step number, press Goto on the controller, type the step number on the numeric keypad then press A [Press to cut cue Live]. After pressing Goto you can also press D [Cue -1] or E [Cue +1] to move forward and backwards.

The Reverse button of the controller will reverse the direction of the chase. If the chase is paused, it will also resume playback.



## 7.2.5 Viewing Chase steps

You can preview the steps in a chase on the display. The chase does not have to be connected or running.

- 
- 1> *Press View.*
  - 2> *Press the Connect/View button of the chase to view.*
  - 3> *A window will open on the VDU showing the steps.*
- 

## 7.3 Edit

### 7.3.1 Opening a chase for editing

You can open a chase for editing by pressing Rec Chase then the Go/Swop button of the chase. This does not affect any existing cues in the chase. You can then save new cues at the end using the A [Append] option, or you can insert/overwrite cues using the C [Insert] button.

### 7.3.2 Editing a chase using Unfold

The Diamond has a powerful chase editing system. The Unfold button places each cue in a chase on one of the playback faders, allowing you to fire and edit each cue individually as if it was a stand-alone cue. Unfold also allows you to set individual timing for cues in the chase.

- 
- 1> *Press Unfold (top left of numeric keys), then the Go/Swop button of the chase to be edited.*
  - 2> *The first 28 cues of the chase are loaded into the playback faders (14 for the Diamond Elite). The displays show the legends for each cue (or the cue numbers if you haven't set individual cue legends).*
  - 3> *Raise a playback fader to output the contents of that cue (fade times will operate as programmed).*
  - 4> *Various Unfold options are available, the details are below.*
  - 5> *Press Unfold again to get out of unfold mode.*
- 

- To edit the contents of a cue: Press Clear to empty the programmer, raise the fader to output the cue, make the changes, press A [Record], then the Go/Swop button for the cue number.
- To change individual times for the cue, press B [Set Cue Times], then the Go/Swop button for the cue (or type the cue number), then set the times. To change global times for the chase (which apply to every step which hasn't had an individual time set) press H [Set Global Times]. This is described in detail in the Timing section on the following page.
- To Insert a new cue, set up the look for the new cue, press C [Insert], then type the cue number for the new cue (such as 1.5 to go between 1 and 2). If this cue number already exists it will be merged with the look you have created. Otherwise a new cue is inserted.
- To Delete a cue, press D [Delete] then the Go/Swop button for the cue you want to delete, or press the blue Delete button followed by the Go/Swop button.
- To copy a cue, press E [Copy], press the Go/Swop button of the cue to copy, then press the Go/Swop button of the destination

cue. Option A lets you set whether the legend is copied with the cue.

- You can renumber the cues in a chase using option H [Renumber Cues]. Each step in the chase will be renumbered to sequential whole numbers. If the cue legends for each step in the chase have not been edited then these will be updated to reflect the new chase numbers. If they have been edited they will remain the same. This option is particularly useful if you have inserted many steps in the middle of the chase and want to return the chase steps to a fixed interval.
- If the chase has more steps than there are playback faders, you can go between pages using the Playback Page-1 and Page+1 buttons.

### 7.3.3 Editing a chase which is running

You can also edit cues in a paused chase without using Unfold. This uses the Rec Step button of the controller.

- 
- 1> *Start the chase and press the Pause button to pause it.*
  - 2> *Keep pressing the Pause button to step on to the step you want, or press Goto and enter the step number you want. The Live and Next step numbers are shown on the display above the controller wheel.*
  - 3> *Press Clear to make sure the programmer is empty.*
  - 4> *Make the changes that you want to the current step.*
  - 5> *Press Rec. Step, then Enter, to save the changes to the step. (You can change the Record by Fixture/Channel/Mask/Stage mode using softkeys G-J if you need to).*
  - 6> *Press the Pause button to jump on to the next step.*
- 

- You can also use Shift+Rec Step to record into the Next step rather than the current one.
- The Rec Times button on the controller is not available for chases, only for Cue Lists.

## 7.4 Copy

### 7.4.1 Copying chases

You can copy a chase in exactly the same way as a cue.

- 
- 1> *Press the blue Copy button (bottom right).*
  - 2> *Press the Go/Swap button of the playback you want to copy. (To make a linked copy press the Flash button instead)*
  - 3> *Press the Go/Swap button of the playback where you want to store the copy.*
- 

Press E [Press to latch menu] to keep the copy mode active. You can keep copying using steps 2 and 3 without having to keep pressing the Copy button. Press Up to leave latched copy mode.

Press B [Press to include legend] to set whether or not the legend is copied with the chase or cue list.

## 7.4.2 Copying single cues from one chase or cue list to another

You can copy a single cue out of a chase or cue list and insert it into another chase or cue list.

- 
- 1> Press the blue Copy button (bottom right).
  - 2> Press F [Copy Cues From Playback].
  - 3> Select a chase or cue list from the softkeys.
  - 4> Select the cue you want to copy by entering the cue number on the keypad, or use the F-J softkeys to select a cue.
  - 5> Press A [Select Destination] and press the playback Go/Swop button where you want to store the cue.
- 

## 7.5 Delete

### 7.5.1 Deleting a chase

To delete a chase:

- 
- 1> Press the blue Delete button (bottom right).
  - 2> Press the Go/Swop button of the playback you want to delete.
  - 3> Press the Go/Swop button again to confirm the delete.
- 

Press E [Press to latch menu] to keep the delete mode active. You can keep deleting using steps 2 and 3 without having to keep pressing the Delete button. Press Up to leave latched delete mode.

### 7.5.2 Deleting a step from a chase or cue list

You can delete a step from the connected chase:

- 
- 1> Open the chase or cue list for editing by pressing Rec Chase (or rec cue list) then the Go/Swop button for the chase or cue list.
  - 2> Press the blue Delete button (bottom right).
  - 3> Type the cue number you want to delete and press Enter.
- 

You can also press Delete and use the option F [Delete Cues From Playback].

Alternatively you can Unfold the chase or cue list, and press D [Delete]. Either type the Cue/Step number and press Enter, or press the Go/Swop button of the cue/step you want to delete twice.

## 7.6 Moving

### 7.6.1 Moving a chase

To move a chase to a different playback:

- 
- 1> Press the blue Move button (bottom right of console).
  - 2> Press the Go/Swop button of the chase to be Moved.
  - 3> Press the Go/Swop button of the playback (or the Select/Swop button of the preset fader) you want to Move it to.
  - 4> E [Press to latch menu] keeps the Move mode active, so you can keep Moving things without having to keep pressing the Move button. Press Up to leave Move mode.
-

## 7.7 Timing

### 7.7.1 Global timings for chases

When a chase is first programmed, each cue in the chase has identical timing. This is called the global timing for the chase. If you want you can then set each cue to have its own timings using Unfold. This is described in the next section.

- 
- 1> *Press A [Set Times] from the top level menu then the Go/Swop button of the chase, or connect the chase to a controller and press the Rec Times button.*
  - 2> *Set the Crossfade, Speed, Fixture Overlap and Attribute Overlap settings as described below.*
  - 3> *Press Up to finish.*
- 

- To set crossfade, press B [Xfade] then type the fade from 0 – 100 and press Enter. 0=no fade (the chase will “snap”), 100=max fade (the chase will move continuously from cue to cue)
- To set speed, press C [Speed] then type the new speed, then press Enter. The speed can be set in Beats Per Minute (BPM) or seconds depending on the user settings. Press C repeatedly in time with the music to set the speed to match the music (tap tempo function).
- You can set the first cue of the chase to either fade in using the crossfade settings or to start instantly. Press F so the option shows [Cue 1 use Fade Time] for fading or [Cue 1 Skip Fade Time] for instant start.
- The other options on the Set Times menu are described in the Advanced Options section 7.8.1 on page 183.

The Overlap functions allow you to offset and overlap the timing of changes in the chase. This can create really amazing visual effects with hardly any programming. The best way to learn about overlap is to program a chase with two cues involving several fixtures, then experiment with the overlap settings to see the various “roll” and “peel off” effects which result.

The following diagram shows you the effects of cue overlap, fixture overlap and attribute overlap in chases.

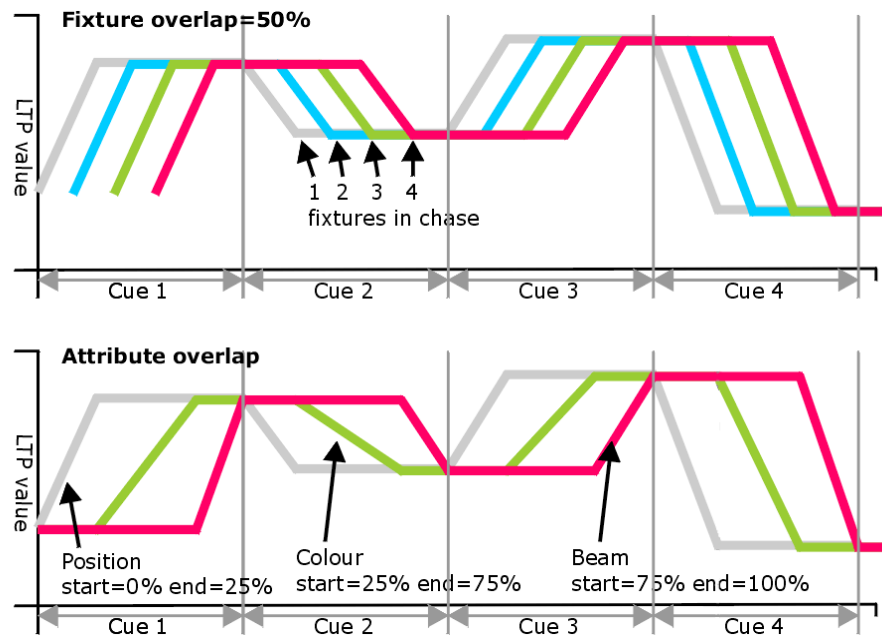

- Press D [Fixture Overlap] then enter 0-100 on the keypad to change how fixtures overlap in the cue. 100% (the normal setting) means all fixtures fade together. 0% means that the first fixture will finish its fade before the next one starts giving a “rolling” change across a range of fixtures. 50% means that the 2<sup>nd</sup> fixture will start fading when the first one is half way through its fade. The order of the fixtures is set by the order you selected them when the cue was saved; you can change the order using Unfold.
- Press E [Attribute overlap] to set how each attribute group fades between steps. For example you can make the Position fade happen in the first half of the step time (Position Start=0% and End=50%), then the colour change happen in the second half of the step time (Colour Start=50% and End=100%). There are also “All start” and “All End” options to set all the start and end times together.

### 7.7.2 Individual cue times in chases

You can configure each cue in a chase to have its own timing information. You need to use the Unfold function to set individual times for cues in chases.

- 1> Press Unfold (top left of numeric keys), then the Go/Swap button of the chase to be edited.
- 2> Press B [Set Cue Times] then the Swap button of the cue you want to edit.
- 3> Set up the timing options as required. The options are described below.
- 4> Press Up when you have finished editing the times for the cue, or you can select a different cue to edit by pressing I [Select Cue].
- 5> Press Unfold to get out of unfold mode.

Initially all the timing options are set to Global. You can cancel any individual timings and set the time back to global timings by pressing the softkey for the option then pressing B [Global].

- To set the delay time (wait before the fade starts) press B [Delay

Time]. To set the fade in time press C [Fade time].

- The Delay Out time is normally zero and the Fade Out time is normally set to be the same as the Fade in time. You can set them to different times by pressing E [Out Time]. In the Out Time menu, C [Clear times] will reset the delay to zero and the Fade Out to be the same as fade in. D [Use Global times] will set the delay and fade times to be the same as the global times for the chase.
- The Fixture Overlap functions are set as described in the previous section.
- The Attribute Overlap function is replaced by fade times for IPCGBES attribute groups and for individual attributes, the same as for stand-alone cues. See section 6.7.2 on page 170 in the previous chapter for details of attribute fade times.
- You can unlink the cue from the previous cue (so that the cue will wait for you to press Go). Press F [Advanced Options] then B [Link] so that the option shows [Link=Off].

### 7.7.3 Setting fixture order for Overlap functions

Normally the order in which the fixtures respond when using Overlap functions is set by the order in which you selected them. However you can change this:

- 1> *Unfold the chase.*
- 2> *Press B [Set Cue Times] and press the Swop button of the cue you want to edit.*
- 3> *Press H [Set Fixture Order]*
- 4> *The display below the fixture presets changes to show the order on the bottom line.*
- 5> *Reorder the fixtures by typing the start number on the numeric keys, then pressing the Select buttons in the order you want them. For example, to set the order of 8 fixtures, press 1 on the keypad, then press the Select button of the fixture to be first, then the Select button for the second, and so on. This display shows the first 8 fixtures in reversed order.*
- 6> *You can set multiple fixtures to the same number if you want them to change at the same time.*
- 7> *Press Up to finish setting the fixture order.*



### 7.7.4 Viewing timing information

You can view the timing settings of a connected chase or cue list by pressing the View button on the Chase Controller; alternatively press View (below Softkey B) then the Connect/View button of the playback.

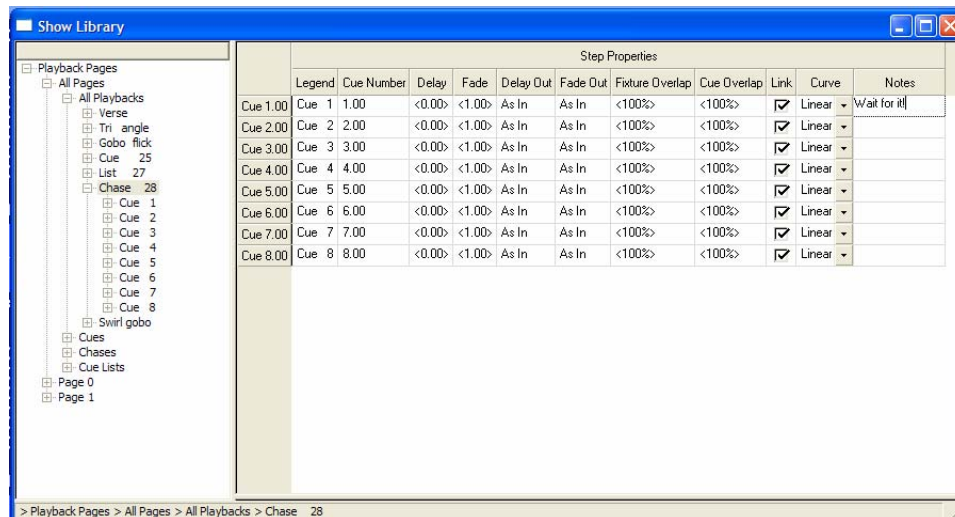

A window opens on the display showing the details of the chase or cue list. A black bar indicates the current cue and fades in and out as the cue fades occur. The delay and fade timers also count down as the cues are fired.

You can edit any field of the chase or cue list using this window (except the AutoLoad field), using the trackball and keyboard.

## 7.8 Advanced options

### 7.8.1 Playback Options

You can enter the playback options menu by doing the following

- 1> Press B [Playback Options].
- 2> Press the blue Swop key for the playback you wish to edit.

Or by

- 1> Connect a list or chase to a controller.
- 2> Press the 'Options' key on the controller panel.

This menu presents you with the following options:

- A [Release Settings]
  - A [Freeze all attributes] The Fixtures LTP channels will stay in the same position when the playback is Killed.
  - B [Release all attributes] All LTP attributes will return to the Power On position with the dimmer turned off. (The position they were in when initially patched)
  - C [Release all but pan/tilt] Pan and Tilt will stay in position, all other LTP attributes will return to the Power On position.
- B [Stop On Last Cue = Off] Set the chase to be non-stop (loops back to cue 1) or to stop on the last cue. If the chase has stopped on the last cue, a message is displayed on the playback controller.
- C [Play Order = Forward] Set the chase direction to be Forward, Reverse, Bounce or Random. (You can press the Reverse button on the controller to temporarily reverse the chase).
- D [Playback Priority = Medium/High/Low] Sets the priority of the

playback. A playback set to a higher priority cannot be overridden if you fire a playback of lower priority. This is useful if you want to create a playback which will always stay active no matter what other playbacks you fire.

- F [Global Link =Not Used] Set the Chase to use global or individual cue link settings, the 3 options are:
  - Not Used: Uses the individual Step Settings for the Chase, which by default will run normally.
  - ON: The Chase will always run normally and ignore individual Step Link settings.
  - OFF: The Chase will ignore individual step settings and Halt at each step like a list.
- The existing chase option [Cue 1 Use Fade Time] has moved to the 'Set Times' menu, softkey F, and [Renumber Cues] has moved to the Unfold menu.

### 7.8.2 Using MIDI with chases

You can fire a chase from a MIDI device. See section 6.8.3 on page 171 for details.



## 8. Cue Lists

*This chapter contains: Programming a cue list; running a cue list; editing, copying and deleting cue lists; setting fade times; cue list options.*

Cue Lists are ideal for running theatrical shows. Each cue can have its own timings, can be triggered by the Go button and can be configured to start other cues and chases on the console.

Cue lists differ from chases in the way the console handles changes between cues. Chases will crossfade between cues whereas a cue list will track changes.

For example: You record dimmer 1 in cue 1, press clear, record dimmer 2 in cue 2, press clear, record dimmer 3 in cue 3. If this were a chase, when you play it back each cue will fade out the dimmer from the previous cue, as it is not in that cue. Therefore once you get to cue 3, you will only have dimmer 3 active.

Cue lists on the other hand track the cues. This means that it only knows about the changes, so in going from cue 1 to 2 it won't change dimmer 1 as there is no data about dimmer 1 in cue 2. This means that once you get to cue 3, it will have accumulated the data from all the cues and the output will consist of dimmers 1, 2 and 3 together.

If you wanted cue 2 to turn off dimmer 1, you would have to explicitly set the level of dimmer 1 at zero (by selecting it and setting the Intensity to 0); or you can miss out pressing Clear in between saving each cue.

The upshot of all this is that you need to be mindful of what is actually being saved in each cue when you record your cue list.

### 8.1 Create

#### 8.1.1 Programming a cue-list

You need to set up the look on the stage for each cue and then add it to the cue list. If you want to set fade times, you can either set them while saving the cues or later.

- 1> *Press the Rec Cue List button (below softkey D).*
- 2> *Press the Go/Swop button of the playback where you want to store the Cue List.*
- 3> *Select the Record Mode of the console: by Fixture, Channel, Mask or Stage using softkeys G-J. J [Record Stage Hard Cue] is safest as you are sure to record the whole console output. See section 6.7.1 on page 167 for a description of these modes.*
- 4> *Set the default Delay and Fade times using softkey D. These times*



Rec Cue List button

*will be allocated to all cues until you change them.*

- 5> *Set up the look for the first cue, either manually or by using "Include" on existing cues.*
  - 6> *Press the Go/Swap button of the playback or A [Append Cue] to store the programmer contents as Cue 1 of the cue list.*
  - 7> *If you want to change the timings for the cue you just saved, press B [Set times] (see section 8.7.1 on page 191 for details of Times).*
  - 8> *Repeat from step 5 for the next cue. Do not press Clear in between cues, unless you want levels to track through from previous cues, as any faders moving to zero will not be stored. If you do press clear, you must make sure that all channels you want to record are selected or in the programmer (inverted display).*
  - 9> *Press Exit to finish when you have stored all the cues you want.*
- 

You can reopen the cue list for editing by repeating the procedure above; this does not affect any cues already stored in the cue list. While the cue list is open for editing:

- To add more cues to the end of the existing cues press A [Append cue].
- You can change a cue by pressing C [Insert Cue], then entering the cue number you want to change. The existing cue will be overwritten. You can insert a new cue by entering a number in between two existing cues, for example enter 2.5 to insert a cue between 2 and 3.
- You can set a legend for each cue which is displayed above the playback fader. Press B [Set times] then E [Advanced options] then F [Set legend]. You can also set a text note using G [Set notes]; this is displayed above the Chase Controller.
- If you need to run a chase as part of a cue, you can do this using an Autoload. See section 8.8.1 on page 193.
- There is no limit to the number of cues in a cue list.

### **8.1.2 Programming a cue-list from existing cues**

You can create a cue list from existing cues rather than creating the cues from scratch.

- 
- 1> *Press the Rec Cue List button (below softkey D).*
  - 2> *Press A [Record List From Existing Cues]*
  - 3> *Press the Select buttons of the cues you wish to have in the cue list, in the order you want them.*
  - 4> *Press A [Record Cue List] and select the handle where you want to store the cue list.*
-

## 8.2 Playback

### 8.2.1 Connecting a cue list to a Controller

To run a Cue List, you need to manually connect it to a controller.

- Press the Connect button (below chase control A or B wheel) then the Connect/View or Swop button above the cue list you want to control.
- The display above the controller shows the cue list name, current cue number or legend and % progress of fades (WFG means "Waiting for Go"). If you have programmed any text notes they are displayed in the central area as shown in the picture on the right.

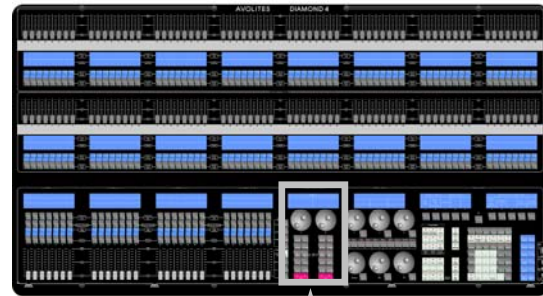

Chase controllers

- The display above the playback fader shows the current and next cue legends.
- Disconnect a cue list from the controller by double pressing the controller's Connect button.
- You can run a cue list without a controller, if you don't need any of the controller displays or functions, by raising the fader and using the Go/Swop button above the fader to fire the cues.
- Autoconnect does not operate on cue lists.

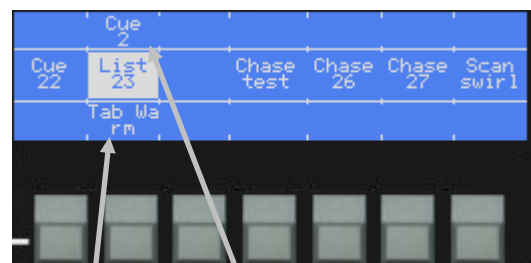

Live cue Next cue

### 8.2.2 Running a cue list

Having connected the cue list to a chase controller, raise the fader and press the Go button to run the first cue.

- The HTP levels of cues in the cue list are mastered by the fader level.
- You can pause a fade by pressing the Pause button on the controller (not the Pause/Preload button above the playback). Press the Go button to resume the fade. If you press the Pause button again while the cue is paused, it will snap to the next cue.
- You can reverse a fade and go back to the previous cue by pressing the Reverse button on the controller. The previous fade

will be reversed, returning the output to the previous cue. This is useful if you press Go accidentally or for repeated curtain calls.

- When running a cue list the flash button for that particular playback will stop the list running then will fade the list back a step when pressed again.
- When you lower the fader for a cue list, the HTP channels will fade out, but the cue list will remain active. You need to kill it by pressing Shift and the Go/Swop button for the playback.
- You can set the cuelist to automatically preload the next cue using option F [Preload] in Playback options. This will pre-position all LTP channels, if the fixture intensity is zero.

There are many options you can set to determine the way the cue list runs and these are described in the rest of this chapter.

### 8.2.3 Viewing Cue List steps on the VDU

You can view the contents of a cue list on the VDU.

- 
- 1> *Press the Connect/View button of the cue list to view.*
  - 2> *A window will open on the VDU showing the steps.*
- 

- The current cue is shown in red and the next cue is shown in grey.
- You can make the cue which is next to fire stay in the centre of the cuelist view window by right clicking on the view window.
- The cue list does not have to be connected or running, but if the cue list is connected, you can also show this window by pressing the View button on the controller the cue list is connected to.

## 8.3 Edit

### 8.3.1 Opening a cue list for editing

You can open a cue list for editing by pressing Rec Cue List, then the Go/Swop button of the playback. This does not affect any existing cues in the cue list. You can then save new cues at the end using the A [Append] option, or you can insert/overwrite cues using the C [Insert] button.

### 8.3.2 Editing a cue list using Unfold

The Diamond has a powerful editing system for cue lists. The Unfold button places each cue of the cue list on one of the playback faders. This allows you to fire and edit each step individually as if it was a stand-alone cue.

- 
- 1> *Press Unfold (top left of numeric keys), then the Go/Swop button of the cue list to be edited.*
  - 2> *The first 28 cues are loaded into the playback faders (14 for the Diamond Elite). The displays show the cue numbers and legends.*
  - 3> *Raise a playback fader to output the contents of that cue (fade times will operate as programmed).*
  - 4> *Various Unfold options are available, the details are below.*
  - 5> *Press Unfold again to get out of unfold mode.*
- 

- To edit the contents of a cue: Press Clear to empty the

programmer, raise the fader to output the cue, make the changes, press A [Record], then the Go/Swop button for the cue number.

- To change the times for the cue, press B [Set Cue Times], then the Go/Swop button for the cue (or type the cue number), then set the times (see Timing on the following page)
- To Insert a new cue, set up the look for the new cue, press C [Insert], then type the cue number for the new cue (such as 1.5 to go between 1 and 2) and press Enter. If this cue number already exists the existing cue is overwritten. Otherwise a new cue is inserted.
- To Delete a cue, press D [Delete] or the blue Delete button then the Go/Swop button for the cue you want to delete.
- To copy a cue, press E [Copy]. . Select whether the legend is to be copied with the cue using option A. Press the Go/Swop button of the cue to copy, then select whether the new cue is to be inserted A [Before] or B [After] the destination cue. You can also C [Merge] and D [Replace] an existing cue. Finally press the Go/Swop button of the destination cue.
- To renumber all cues into sequential whole numbers use option G [Renumber Cues]. This is useful if you have had a lot of changes and have ended up with lots of strange cue numbers.
- If the cue list has more cues than there are playback faders, you can swop to the next page using the Playback Page-1 and Page+1 buttons.

### 8.3.3 Editing a cue list which is running

You can also edit cues in a cue list while you are running it without using Unfold. This uses the Rec Step button of the controller.

- 
- 1> *Connect the cue list to a controller by pressing Connect on the controller then the Connect/View button of the cue list.*
  - 2> *Raise the fader of the cue list.*
  - 2> *Keep pressing the Pause button on the controller to step on to the cue you want, or press Goto and enter the cue number you want. The live cue number is shown on the bottom line of the display above the controller wheel.*
  - 3> *Press Clear to make sure the programmer is empty.*
  - 4> *Make the changes that you want to the current step.*
  - 5> *Press Rec. Step, then Enter, to save the changes to the step. (You can change the Record by Fixture/Channel/Mask/Stage mode using softkeys G-J if you need to).*
  - 6> *Press the Pause button to jump on to the next step.*
- 

- You can also use Shift+Rec Step to record into the Next step rather than the current one.
- You can type in a different cue number after pressing Rec Step if you want to save to a different cue.

You can edit the times for a cue using the Rec Times button of the controller as follows:

- 
- 1> *Connect the cue list to a Controller and run the first cue.*
  - 2> *Press the Rec Times button to set the times for the current step, or Shift+Rec Times for the next step. The Live and Next step numbers are shown on the display above the controller wheel.*
  - 3> *Use the softkeys to set the times you want (see section 6.7.1 on page 167 for description of the times)*
  - 4> *Press the Pause button to jump to the next cue, the Reverse button to go back one, or the Goto button to jump to a different cue.*
- 

- You can also use Unfold to set the times as described in the Unfold section above.

## 8.4 Copy

### 8.4.1 Copying cue lists

You can copy a cue list in exactly the same way as a cue.

- 
- 1> *Press the blue Copy button (bottom right).*
  - 2> *Press the Go/Swap button of the playback you want to copy. (To create a linked copy, use the Flash button instead)*
  - 3> *Press the Go/Swap button of the playback where you want to store the copy.*
- 

Press E [Press to latch menu] to keep the copy mode active. You can keep copying using steps 2 and 3 without having to keep pressing the Copy button. Press Up to leave latched copy mode.

Press B [Press to Include Legend] to set whether or not the legend is copied with the cue list.

To copy a cue within the cue list, you use the Unfold function (see section 8.3.2).

You can copy a single cue out of a chase or cue list and place it on its own playback fader. See section 7.4.2 on page 179 for details.

## 8.5 Delete

### 8.5.1 Deleting a cue list

To delete a cue list:

- 
- 1> *Press the blue Delete button (bottom right).*
  - 2> *Press the Go/Swap button of the playback you want to delete.*
  - 3> *Press the Go/Swap button again to confirm the delete.*
- 

Press E [Press to latch menu] to keep the delete mode active. You can keep deleting using steps 2 and 3 without having to keep pressing the Delete button. Press Up to leave latched delete mode.

### 8.5.2 Deleting a step from a cue list

You can delete a step from a cue list like this:

- 
- 1> *Open the cue list for editing by pressing Rec Cue List then the Go/Swap button for the cue list.*
  - 2> *Press the blue Delete button (bottom right).*

---

3> *Type the cue number you want to delete and press Enter.*

---

Alternatively you can Unfold the chase or cue list, and press D [Delete]. Either type the cue number and press Enter, or press the Go/Swop button of the cue you want to delete twice.

## 8.6 Moving

### 8.6.1 Moving a cue list

To move a cue list:

- 
- 1> *Press the blue Move button (bottom right of console).*
  - 2> *Press the Go/Swop button of the cue list to be Moved.*
  - 3> *Press the Go/Swop button of the playback (or the Select/Swop button of the preset fader) you want to Move it to.*
  - 4> *E [Press to latch menu] keeps the Move mode active, so you can keep Moving things without having to keep pressing the Move button. Press Up to leave Move mode.*
- 

## 8.7 Timing

### 8.7.1 Time and fade options for Cue Lists

Time settings are independent for each cue in the cue list. The top line of the display above softkeys A-E shows which cue you are working with. You can select which cue is active using the Go, Pause, Reverse and Goto buttons of the controller, or softkey I of the Set Times menu.

See the diagrams in section 6.7.1 on page 167 and section 7.7.2 on page 181 for more information about overlaps and fade times.

- 
- 1> *Press Rec Times if you have a chase controller connected, or press A [Set Times] from the top level menu then the Go/Swop button of the Cue List.*
  - 2> *To change which cue you are editing, press I [Select Cue] then type the cue number you want to edit and press Enter.*
- 

- To set the delay time before the cue starts once the Go button has been pressed, press B [Delay time] then type a time in seconds and press Enter.
- To set the fade-in time of the cue, press C [Fade time] then type a time in seconds and press Enter. Both HTP and LTP channels are affected by the fade.
- The fade-out time of the cue is set by default to be the same as the fade in time. You can change the Fade-Out time by pressing E [Set Out Time]. You can then set the delay out time by pressing A [Delay] or the fade out time by pressing B [Fade]. If you want to set the fade out time to be the same as the fade in time, press A [As In] from the fade out menu.
- You can set a different fade curve for the cue. For example this could allow you to start the fade slowly, then speed up, then slow down again at the end. See the advanced options section 8.8.1 on page 193 for details.
- You can set default Delay and Fade times which are used for new

cues using D [Default Delay/fade] at the main Rec Cue List menu. Changing the default times does not affect existing cues.

- You can set up a cue list to be triggered automatically by external timecode. See section 10.1.1 on page 203.

### 8.7.2 Individual attribute fade times

You can set individual fade times for each IPCGBES attribute group. You can also select which fixtures this is applied to. For example you can make the position change take 2 seconds, but the colour change take 10 seconds.

Additionally you can set individual times for each attribute so you could make the pan fade over a different time to the tilt.

To set times for an attribute group, first select the Set Times menu and go to the cue you want to set as described above.

- 
- 1> Press F [Set IPCGBES times].
  - 2> All fixtures in the cue will be selected. If you don't want to change the times for any fixtures, deselect them now. You can press the ALL button (to the right of wheel 3) to select all fixtures in the cue or Shift+ALL to deselect all fixtures.
  - 3> Press the softkey for the attribute group you want to change.
  - 4> Press A [Set Delay] to set the delay time, or press B [Set Fade] to set the fade time. Press E [Clear Times] to remove the attribute group timing and go back to the normal delay/fade times for the cue.
- 

Setting times for an individual attribute is very similar:

- 
- 1> Press G [Set attribute times].
  - 2> All fixtures in the cue will be selected. If you don't want to change the times for any fixtures, deselect them now. You can press the ALL button (to the right of wheel 3) to select all fixtures in the cue or Shift+ALL to deselect all fixtures.
  - 3> Press the softkey for the attribute you want to change. The I and J buttons move between pages of attributes if there are more than 8.
  - 4> Press A [Set Delay] to set the delay time, or press B [Set Fade] to set the fade time. Press E [Clear Times] to remove the attribute timing and go back to the normal delay/fade times for the cue.
- 

### 8.7.3 Cue and fixture overlap

If you are running cues in an automatic sequence (linked together) the Diamond allows you to overlap the cues such that the second cue will start to run before the first one has finished.

- Press A [Link Offset = x%] to set the cue overlap from 0 to 100%. 100% means that the previous cue must be 100% complete before the this cue starts (the normal setting). 50% means that this cue will start when the previous cue is half way complete.

You can also set fixture overlap, which causes the Diamond to apply the settings in the cue to each fixture sequentially giving a "rolling" change across the fixtures in the cue. This can create some great effects



without much programming on your part.

- Press D [Fixture Overlap] then enter 0-100 on the keypad to change how fixtures overlap in the cue. 100% means all fixtures fade together (the normal setting). 0% means that the first fixture will finish its fade before the next one starts. 50% means that the 2<sup>nd</sup> fixture will start fading when the first one is half way through its fade.

- To change the fixture order when using overlap, press H [Set Fixture Order].

Normally this is the order in which you selected the fixtures.

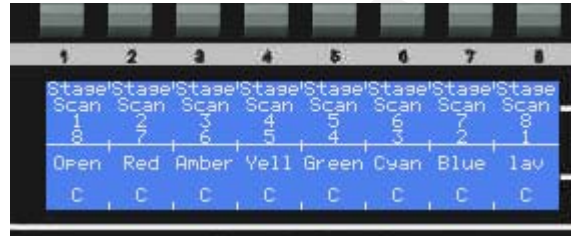

The display below the fixture presets changes to show the order on the bottom line. You can reorder the fixtures by typing the start number on the numeric keys, then pressing the Select buttons in the order you want them. For example, to set the order of 8 fixtures, press 1 on the keypad, then press the Select button of the fixture to be first, then the Select button for the second, and so on. You can set several fixtures to the same number if you want them to change simultaneously, or set them to 0 if you don't want them to take part in the overlap effect. This display shows the first 8 fixtures in reversed order.

Press Up to finish setting the fixture order.

#### 8.7.4 Viewing timing information

You can view the timing settings of a connected cue list by pressing the View button on the Chase Controller, or you can just press the Connect/View button of the playback.

A window opens on the VDU showing the details of each cue in the cue list. The current cue is shown in red and the next cue is shown in grey.

## 8.8 Advanced options

### 8.8.1 Playback Options

You can enter the playback options menu by doing the following

---

1> Press Softkey B "Playback Options".

2> Press the blue Swop key for the Cue List you wish to edit.

---

Or

---

1> Connect a list or chase to a controller.

2> Press the 'Options' key on the controller panel.

---

This menu presents you with the following options:

- A [Link] if On, links this cue to the previous one (in other words this cue will automatically start when the previous one finishes). If Off, the console waits for the Go button (WFG).
- B [Shape Size] if on, sets the fader to control the size of shapes in the current cue. The Size is controlled from zero up to the programmed setting. This is useful for intensity shapes as it

allows you to fade in the intensity from zero, also it allows you to smoothly bring in a big movement shape.

- C [Shape Speed] if on, sets the fader to control the speed of shapes in the current cue. The Speed is controlled from Stop up to the programmed setting.
- D [Curve] allows you to set a different fade curve for the cue; this affects how the fade progresses from one cue to the other (for example you can select a fade which starts off slow, speeds up in the middle and then slows down at the end). Press H then select a new curve from the softkeys. The effect of the various curves is described in section 11.4 on page 218.
- E [Autoload] allows you to make this cue list load another cue, chase or cue list from the playback faders. Press B then press the Go/Swop button of the playback you want to load. (Note you can only Autoload from a cue list).  
The autoload function has further options:

- A [Remove Autoload] removes the autoload from this cue
- B [Autoload Cue within Playback] allows you to start a chase or cue list from a specific cue, rather than the first one. You need to also ensure that the playback is set to Autoload.
- F [Go Press On Playback] sets the autoload to act as a "Go" press on the cue list it's loading
- F [Preload] tells the console to preload the LTP settings of the next cue, for fixtures with zero intensity.
- G [Set Legend] allows you to set a legend for the cue which is displayed above the playback fader when the cue list runs.
- H [Set Notes] lets you enter a note for the cue ("Leaves stage pursued by bear" or "wake up spot operator"). This note is displayed above the Chase Controller.
- I [Select Cue] allows you to jump to a different cue to set the options for that cue.
- J [Cue List Options] Moves Menu to the second page of options.

The second page of options:

- A [Release Settings] Changing the Release Settings will alter the way in which the LTP channels on a Fixture behave when the playback is released.
  - A [Freeze all attributes] The Fixtures LTP channels will stay in the same position when the playback is Killed
  - B [Release all attributes] All LTP attributes will return to the Power On position with the dimmer turned off. (The position they were in when initially patched)
  - C [Release all but pan/tilt] Pan and Tilt will stay in position, all other LTP attributes will return to the Power On position
- B [Stop on last cue = Disabled] When enabled, the list will not wrap back to the beginning of the list after the last cue.

- C [Cue List fader control] When a cue list fader is lowered, the cue list will remain active until you press shift + swop, or OFF / Switch off Playbacks. You can use the fader control, found in the set times menu, to change this. the three options are:
  - None : The cue list will remain active when the fader is lowered. (The default setting)
  - Kill : The cue list will be released when the fader is lowered, the list will restart from the first cue next time it is played.
  - Manual: The next cue will be triggered, and the intensity will remain. this allows you to use the fader as a 'Manual' crossfader.

Note, when switching to 'Manual' control, the Fader Intensity of the playback will be locked at 100%, if it is at 50% when you switch it will bump to 100% when you move it. A released list will fade in with the fader on the first cue, and stay at 100% thereafter.

- D [Playback Priority = Medium/High/Low] Sets the priority of the playback. A playback set to a higher priority cannot be overridden if you fire a playback of lower priority. This is useful if you want to create a playback which will always stay active no matter what other playbacks you fire.
- E [Omit Add/Swop] This setting retains the Play/Pause functions of a Cuelist playback buttons when in Add/Swop Mode, and the Cuelist will not 'Swop' or 'Flash' other playbacks, although it will still get 'Swopped'. this is the default. If turned off, the list will 'Swop' or 'Flash' normally like Cues and Chases, but you will not be able to advance the list unless it is 'Connected' to a controller.
- J [Cue Options] Moves Menu to the first page of options.

### 8.8.2 Using MIDI with cue lists

You can fire a cue list from a MIDI device. See section 6.8.3 on page 171 for details.

Copyright Avolites Limited 2010

## 9. Running the show

*This chapter contains: Operating modes, master faders, manual control during a show, page shortcuts*

### 9.1 Playback

#### 9.1.1 Back up the show

At regular intervals while you are programming, and when you have finished programming (or you've run out of time) and it's showtime, the most important thing is to back up the show to floppy disk, USB pen drive or CD. Even saving it as a new file on the internal disk is better than nothing (see section 1.4 on page 121 for instructions). For a complete live backup system see section 11.3 on page 217

#### 9.1.2 Operating modes

If your show is being operated by a lesser mortal, turn the key to Safe and remove the key. This prevents anyone from altering the programming of the console.

Expert users can run the console in "Operate" mode to allow more flexibility in running the show and live updating of the programming.

#### 9.1.3 Master faders

Master faders are used to control the maximum intensity output from selected areas of the console.

The Diamond does not have dedicated Master faders, but allows you to assign one or more of the playback faders as Master faders. You only need to assign the masters you need, unassigned masters are fixed at 100%.

- 
- 1> *Press J [Utils]*
  - 2> *Press B [Set Masters].*
  - 3> *Select type of master fader (Grand, Playback, Flash, Preset, Swop).*
  - 4> *Press the Go/Swop button of a playback to assign that fader as a Master.*
  - 5> *To unassign a master, press A [Delete] then the swop button.*
  - 6> *Repeat from 3 to assign other faders or press Shift+Up to leave Setup mode.*
- 

- **Grand** Master controls the output level of the entire console.
- **Playback** Master controls the overall level of playback/cue faders.
- **Flash** Master controls the level of cues turned on with the Flash buttons.
- **Preset** Master controls the overall level of the Preset faders.
- **Swop** master controls the level of cues turned on with the Swop buttons

### 9.1.4 Flash and swop buttons

The Flash and Swop buttons on the playback faders may be used at any time to flash and solo cues and chases. The Flash button adds the playback into the current output, the Swop button turns off all other output.

You can also flash and swop individual fixtures or dimmer channels using the Select/Swop and Palette/Flash buttons below the preset faders. To use them for this, you need to enable Add and Swop mode by pressing the Add/Swop button below softkey B. In Add/Swop mode you cannot select fixtures or palettes from the buttons.

Press the Fixture button above it to return the Add/Swop buttons to fixture and palette control.

### 9.1.5 Manual control during a show (“busking”)

If you have not had as much programming time as you would have liked, you might need to make up some additional effects during the show. This is sometimes called “busking”, and is where the fun starts!

You can create instant variations by recalling palette values to modify your existing cues. The Diamond can fade to the palette values for added effect – these are called timed palettes.

- 
- 1> *Select some fixtures which are already in use on stage..*
  - 2> *Type “2” (or any time, in seconds) on the numeric keypad.*
  - 4> *Press a Palette button to recall a palette.*
  - 5> *The selected fixtures will change to the new palette over a time of 2 seconds.*
- 

When a fade is entered, you can also change the “Fixture Overlap” using softkey A. This allows you to create “roll” or “peel” effects when using a series of fixtures. With overlap=100%, all fixtures change at the same time. If overlap=50%, the second fixture will not start its fade until the first fixture is half way (50%) through fading. The order of the fixtures is set by the order in which you selected them.

The fade remains active while the Palette Fade menu is open. Press Up to leave the menu to stop fading.

If you apply a palette with a fade time, then it will be overridden by the next cue (so if you fade to green using a palette, then fire a cue which sets those fixtures blue, they will go blue). If you apply a palette without a fade time, it will go into the programmer and override any subsequent cues (so if you use a green palette with no fade, the fixtures will be locked in green until you press Clear). Timed palettes are not affected by the Clear button.

Having the palette overridden by the next cue is quite useful when “busking”. If you need to “snap” a palette but still have it overridden by the next cue, set a fade time of 0 (leaving the Palette fade menu open).

When programming your palettes, group all the colour palettes in one area of the console, position palettes in another area, and so on. This helps you to find them when the show is running and the pressure is on.

If you are lighting a band, make position palettes for every person on stage so you can spotlight them for those unplanned solos.

You can use Quick Palettes to recall a palette to all the fixtures it applies to, without having to select the fixtures first. Enable the Quick Palettes option in the User Settings, then simply select a palette without any fixtures selected.

You can use "Record by channel" or "Record by mask" mode when programming to set some cues to only affect position, and other cues to set colours, gobos, add shapes, and so on. By combining two or more cues you can produce a much wider range of effects than if all your cues set all the attributes. However, for this to work well you need to make sure you know what attribute is going to be affected by each cue; as if you fire two "colour only" cues then nothing is going to light up.

### 9.1.6 Page shortcuts

The Diamond allows you to make Shortcut keys which will set up the console with a specific Playback page, Fixture page and Palette page. You can also change the VDU desktop layout and store which playbacks are connected to the chase controllers. You could, for example, have a shortcut key for each song which would set the correct page for the playbacks and palettes for that song.

- 1> Press J [Utils] from the top-level menu then D [Record Shortcut].
- 2> Set up the console with the Playback page, fixture page, palette page and desktop layout you want, and connect playbacks to the controllers if you wish to store those.
- 3> The shortcut can change any or all of the above. Press softkeys A-D to select which of the above you want to include. The option is highlighted when it will be included in the shortcut. Use softkeys F and G to select if the connected playbacks will be stored in the shortcut (see below).
- 4> Press a vacant Preset Select (blue) or Palette (grey) button to store the shortcut.
- 5> You can set a legend for the shortcut using the Set Legend button; the default legend shows which pages are programmed in the shortcut.

- F [Wheel A] and G [Wheel B] options can be set to either Playback, Clear or nothing. If set to Playback, the playback currently connected to the wheel will be reconnected when the shortcut is used. If set to Clear, the wheel will be cleared (playbacks will be disconnected from the wheel). If set to nothing, the wheel will not be affected by the shortcut.

This screen shows two shortcuts with set legends (Pb Page 0 and Pb Page 1) and two shortcuts with the default legends showing Playback, Fixture, Palette and Desktop settings.



## 9.2 View Menu

Pressing the grey View button (near to softkey H) takes you into the VDU view options. From here you can set up what is shown on the external monitors. The following options are available:

- A [Virtual Panel] This option brings up an on screen version of the console front panel. this allows the operator to perform on screen all of the functions accessed from the panel.
- B [Intensity] The Intensity view shows you the intensity output of all patched fixtures. The brightness of the graphic shows the intensity of the fixture (White=Full intensity, dark grey=Off). The intensity is also shown as a percentage. By right clicking on this screen you can also enable or disable display of the Legend, control group, DMX address and dimmer curve of each fixture.

Fixtures are highlighted in light blue if they are in the programmer (if their output has been changed by the user). They are highlighted in dark blue if they are currently selected (they are in the editor and the programmer).

- F [Wheels] The Wheels View displays the attribute settings of the three top wheels on the VDU. If you are using a media server active fixture, such as the Hippotiser, the Wheels View can display thumbnails of images and video clips. (This requires AvoTalk to be set up with the media server, see section 14.8 on page 237).

The wheel view can also show a visual representation of CMY colour mixing on screen. If you select a light with CMY colour mixing, then go to the C-Mix attribute bank and open the wheel view, you will see the colour picker. Shows you the current values for CMY and allows you to drag the crosshairs to set a colour using Hue, Saturation and Intensity.

The Hue is the colour and can be set around the edge of the circle

Saturation is the Amount of colour and is set by moving between the centre and the edge

The colour Intensity is set using the slider below the circle.

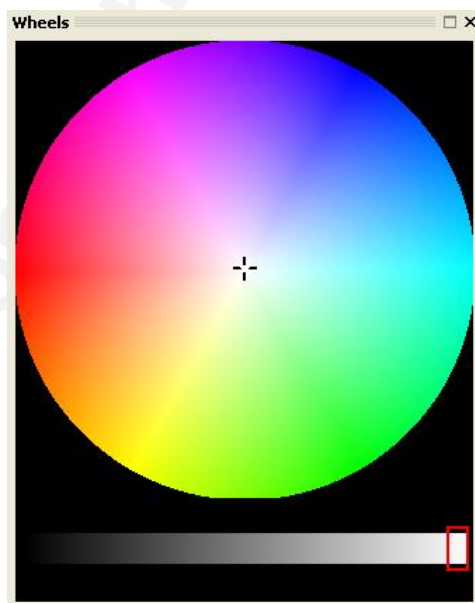



- G [DMX] The DMX view shows the output value of each DMX channel, and which fixture is patched to it.

As with the stage view, you can sort the list on any of the columns by clicking on the column header.

The red values indicate values which are currently changing.

- H [Command Line] The Command Line window shows the commands that the console is currently processing and provides useful feedback, and a status bar which shows what the on-board menu displays are currently showing.

## 9.3 Move

The blue button below the "Setup" key is the "Move" button. This brings up the utilities menu on the softkeys and can be used to move recorded items from one handle to another.

It can also be used to Swop pages, so you can move pages around within your show. It is currently possible to move Fixtures, Groups, Palettes, Playbacks and Shortcuts.

When an item is moved, all links to other recorded items are retained. This allows you to reorganise the layout of the console if things get mixed up by additions and changes.

### 9.3.1 Using the Move function

To move fixtures, palettes, groups and playbacks is very simple. See the following sections for how to move shortcuts and pages.

- 
- 1> *Press the blue "Move" Button.*
  - 2> *Press the blue Swop (or grey Flash) key of the item to move.*
  - 3> *Press the blue Swop (or grey Flash) key of the destination*
- 

Or to move a range of item

- 
- 1> *Press the blue "Move" Button.*
  - 2> *Select a range of items*
  - 3> *Press the blue Swop (or grey Flash) key of the destination of the first item in the range.*
- 

When moving a range, it is possible to select a range containing different types of items, and there can be gaps between them. In this case, all of the gaps in the range will be removed

You can use shortcuts to cross pages whilst moving an item.

If there is not enough space, (there is an item in the way or there is not enough space before the end of the page) then the action will not be completed.

### 9.3.2 Using the Move function for Shortcuts

- 
- 1> *Press the blue "Move" Button.*
  - 2> *Press Softkey A [Move Shortcut].*
  - 3> *Press the grey Flash key of the shortcut to move.*
  - 4> *Press the grey Flash key of the destination.*
- 

It is possible to move a shortcut on top of another item. The item will not be deleted and will be shown again when you move the shortcut

somewhere else.

### **9.3.3 Using the Move function to swop pages**

---

- 1> *Press the blue "Move" Button.*
  - 2> *Press Softkey B [Swop Pages].*
  - 3> *Select the page type to move*
  - 4> *Type in source page.*
  - 5> *Press Enter.*
  - 6> *Type in destination page.*
  - 7> *Press Enter.*
- 

Copyright Avolites Limited 2010

## 10. Timecode playback

*This chapter contains: Enabling cue lists for timecode; assigning timecodes to cues; running a cue list to timecode; changing the timecode for a cue.*

If you need to play back a sequence of cues synchronised to an external source, the Diamond can do this using a Cue List triggered by timecode. The timecode can come from MIDI, from the Windows Winamp audio player, from an internal clock or from the system clock. Effectively the console will press the "Go" button when the timecode matches the set time for a cue.

Timecode playback is useful when the lighting has to be repeated identically time after time or when it has to be tightly synchronised with a sound track, such as in exhibition shows, film sets, or complicated musical sequences. It can also be useful to automatically run lighting when a lighting operator is not available.

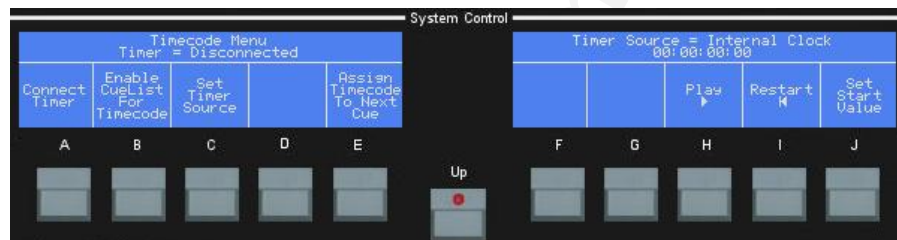

The timecode status is shown on the top lines of the displays.

### 10.1 Create

#### 10.1.1 Enabling a cue list for timecode operation

First you need to program the cue list which you want to operate from timecode. This is described in section 8.1.1 on page 185. If you want to use fade times and autoloads, configure them in the cue list as required.

Then you must enable the cue list for timecode:

- 1> Press C [Timecode] from the top-level menu.
- 2> Press B [Enable cuelist for timecode].
- 3> All programmed cuelists are listed on the softkeys. Press the key for the one you want to use (I and J change pages).
- 4> Press Up to return to the timecode menu.

#### 10.1.2 Assigning timecodes to cues

Each cue in the cue list must have a timecode assigned to it. The console will then activate the cue when the incoming timecode matches the time set for the cue.

The best way to do this is to play the timecode source, and press E [Assign timecode to next cue] at the required cue point.

- 1> Connect the cue list to controller A (press Connect below the wheel, then the Connect/View button of the cue list).

- 2> Push up the playback fader for the cue list.
- 3> Press C [Set Timer Source] to select which timer you require; MIDI, Winamp System Clock or Internal. If using Internal you can press J to set the start time.
- 4> Start the timecode source, or press H [Play] if using the internal timer.
- 5> At the time when you want the cue to start, press E [Assign timecode to next cue]. The cue will run.
- 6> Repeat step 5 until all cues are assigned.
- 7> Press Up to return to the timecode menu.

- The Internal timer can be useful to test a sequence when the external source is not available.
- You can Pause the internal timecode and restart it from the beginning using softkeys H and I.
- If you select Winamp as timer source and Winamp is not running, the console will display a warning on the VDU. The console buttons will become inactive until you click "OK" on this warning.
- You can open the View Timecode window using the VDU View→Timecode menu option. You can also show this window by pressing View on the chase controller then the Connect/View button of the cue list.

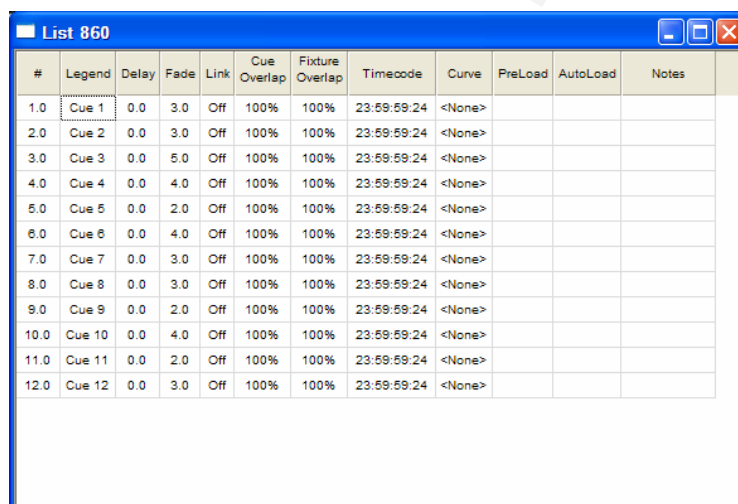

#	Legend	Delay	Fade	Link	Cue Overlap	Fixture Overlap	Timecode	Curve	PreLoad	AutoLoad	Notes
1.0	Cue 1	0.0	3.0	Off	100%	100%	23:59:59:24	<None>			
2.0	Cue 2	0.0	3.0	Off	100%	100%	23:59:59:24	<None>			
3.0	Cue 3	0.0	5.0	Off	100%	100%	23:59:59:24	<None>			
4.0	Cue 4	0.0	4.0	Off	100%	100%	23:59:59:24	<None>			
5.0	Cue 5	0.0	2.0	Off	100%	100%	23:59:59:24	<None>			
6.0	Cue 6	0.0	4.0	Off	100%	100%	23:59:59:24	<None>			
7.0	Cue 7	0.0	3.0	Off	100%	100%	23:59:59:24	<None>			
8.0	Cue 8	0.0	3.0	Off	100%	100%	23:59:59:24	<None>			
9.0	Cue 9	0.0	2.0	Off	100%	100%	23:59:59:24	<None>			
10.0	Cue 10	0.0	4.0	Off	100%	100%	23:59:59:24	<None>			
11.0	Cue 11	0.0	2.0	Off	100%	100%	23:59:59:24	<None>			
12.0	Cue 12	0.0	3.0	Off	100%	100%	23:59:59:24	<None>			

## 10.2 Playback

### 10.2.1 Running a timecode cue list

Once a cue list has been enabled for timecode, you need to make sure a timecode source is selected. Whenever the timecode matches the time set for a cue, that cue will run. You do not need to put up the fader for the cue list or connect it to a controller.

- 1> Press Select the source for the timecode by pressing C [Set timer source].
- 2> If the display shows timer=Disconnected, Press A [Connect Timer].
- 3> Start the timecode source, or press H [Play] if using the internal

*timer.*

- You need to reset the cue list back to cue 1 before it will run again. The easiest way to do this is to release the cue list from its playback by pressing Shift and the Swop button for the playback. If the timecode source is then restarted, the cue list will run again.
- The position of the playback fader does not affect the HTP channels in the cue list when operating from timecode. All HTP levels are set to full.

### 10.2.2 Timecode viewer

Press the grey View button then I [Timecode] to display a window on the VDU showing the current timecode.



The window also shows which timecode source is selected.

## 10.3 Edit

### 10.3.1 Changing timecode for a cue

You can change the timecode for a cue either by reassigning the timecode, or by directly editing the time using the keyboard.

Reassigning the timecode:

- 1> *Connect the cue list to one of the chase controllers (press Connect below the wheel, then the Connect/View button of the cue list).*
- 2> *Push up the playback fader for the cue list.*
- 3> *Press Goto on the chase controller, then type the number of the cue you want to change, then press A [Press to cut cue live].*
- 4> *Run the timecode source.*
- 5> *Press E [Assign timecode to next cue] at the correct time.*

Editing the time on the keyboard:

- 1> *Connect the cue list to one of the chase controllers (press Connect below the wheel, then the Connect/View button of the cue list).*
- 2> *Press View on the chase controller. A window opens on the VDU showing details of the cue list.*
- 3> *Using the trackball, click on the timecode you want to edit and press Enter on the keyboard.*
- 4> *Type the new time on the keyboard. You can use the keyboard cursor keys to select which digit to change.*
- 5> *Press Enter to store the time.*

Copyright Avolites Limited 2010

# 11. User Settings and other options

*This chapter contains: Setting the Diamond options using the VDU menu; the Utilities menu; Tracking Backup with showsafe; dimmer & fade curves; upgrading the software.*

The Diamond has a large number of options to help you set it up just the way you like it. The options are found in two main places, the onscreen Tools menu (on the VDU menu bar) and the Utilities menu (Softkey J on the console displays).

In this chapter there is also information on some other configuration issues – Tracking (Live) backup, explanation of the dimmer and fade curves offered in various places on the console, and how to upgrade the application software.

## 11.1 Tools menu

All the “system” options on the Diamond are set from the Tools menu on the VDU screen.

### 11.1.1 Virtual Panel

This option displays a fully operational “virtual” Diamond front panel on the VDU. You can use this to program a show without a real console.. If you use this option on a real console, or if you have a D4 Pilot unit connected, the faders and displays will change to match the settings made on the real devices, and you can connect an Ez-DMX device to output real DMX from the console.

The virtual panel does not have select or flash buttons. Click the display area below the fader to press the simulated select or flash button.

### 11.1.2 Visualiser

This option displays the visualiser.

### 11.1.3 User settings

The user settings menu allows you to configure the way the Diamond operates. Select the User Settings option on the Tools menu on the VDU to show the User Settings dialog.

Alternatively you can set the same options on the console menu screens by pressing the blue Setup button then F [User Settings].

If the console has different users, each user can have their own option settings. You create new users or select from a list of existing users by clicking the user Change button at the top of the screen. You can also use the File → Change User menu command.

To add a new user, click the Add User button in the Change User dialog and type a user name. To select an existing user, click the username in the list then click OK.

The user settings dialog has the following tabs:

## General tab

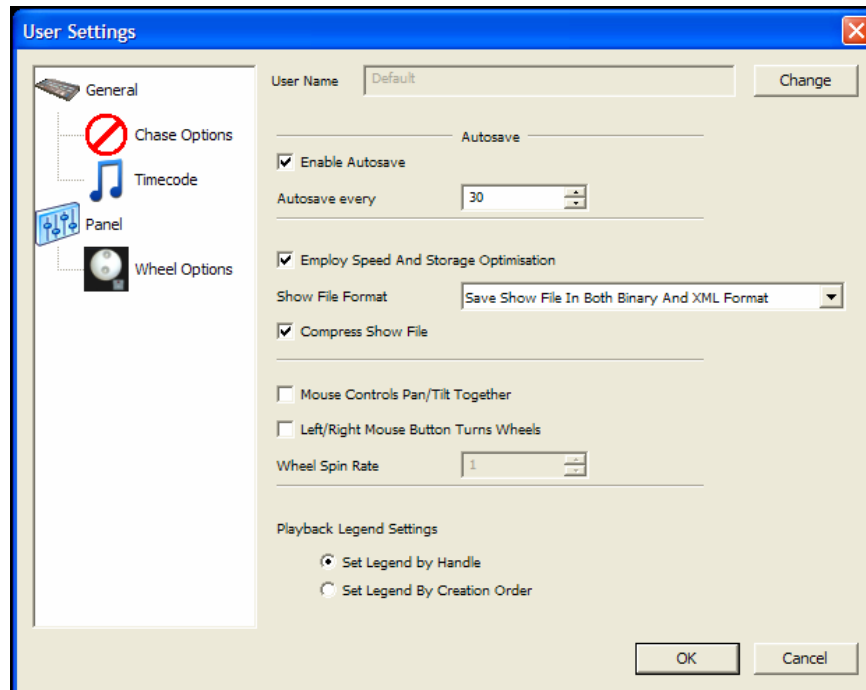

- *Autosave* enables or disables the autosave option and allows you to set how often the show is saved.
- *Employ speed and storage optimisation* will speed up loading and saving by not saving information for the “On” function (see section 6.3.4 on page 165)
- *Show file format* allows you to set how the file is saved. “Both Binary and XML” gives greatest compatibility but is slowest.
- *Compress show file* will cause the Diamond to compress the file before saving.
- *Mouse controls Pan/Tilt together* sets how the mouse operates in the simulator. See section 1.2.5 on page 115 for details of the simulator.
- *Left/Right mouse button turns wheels* is used in the simulator to allow you to spin the wheels by clicking rather than “turning” the wheels with the mouse.
- *Playback Legend Settings* tells the console how it should automatically create legends for new playbacks.
- *External Midi timecode* options allow you to determine what the console will do if it has problems with MIDI timecode. The “Ignore Glitches” setting will discard wildly wrong timecodes which might be caused by a reception error. The “Resynchronise after” setting sets the time after which the console synchronises with the timecode.



## Chase Options tab

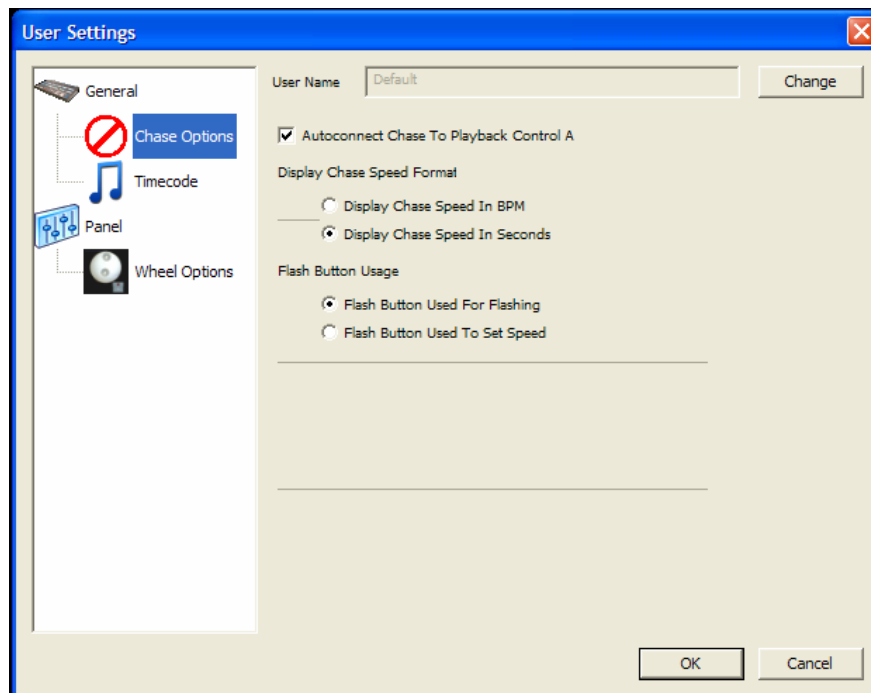

- *Autoconnect chase* will connect a chase to Chase Controller A when the fader is raised. If this is not enabled you have to connect the chase manually using the Connect button.
- *Display chase speed* allows you to select BPM or Seconds for the speed display.
- *Flash button used ...* allows you to configure the flash button of chases to set the chase speed (by tapping it in time with the music) or to be used for flashing.

## Timecode tab

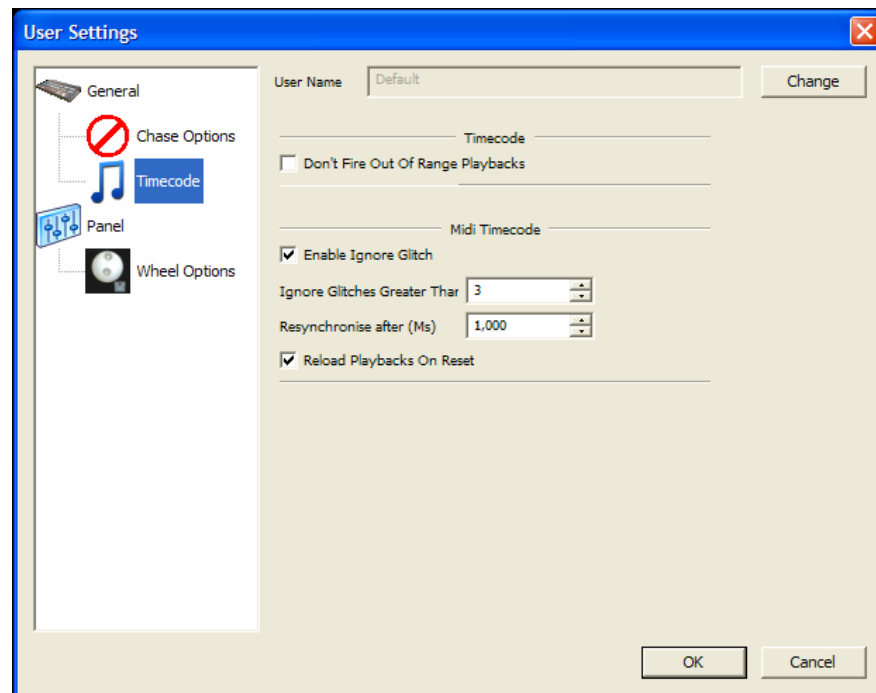

- *Don't fire out of range playbacks* tells the console not to load timecode playbacks that have their last cue time before the current time.
- *Ignore Glitches...* sets how the console should deal with glitches in the timecode.
- *Reload Playbacks on Reset* tells the console to reload playbacks to the initial state when the timecode resets.

## Panel tab

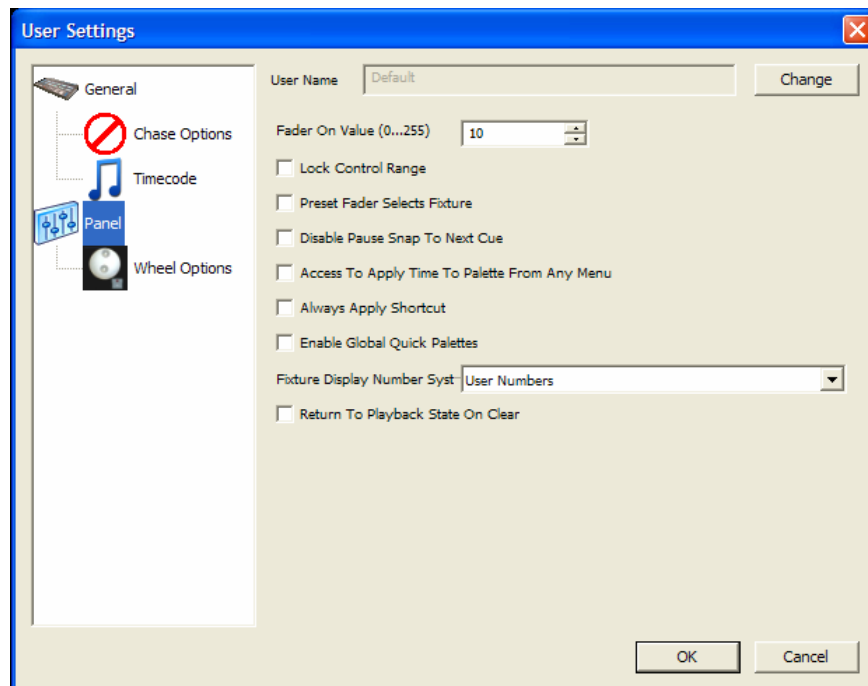

- *Fader On value* sets where a playback fader needs to get to before the LTP channels are turned on (sometimes called the Fader trigger point).
- *Lock control range* prevents you from crossing control ranges using the wheel; you have to use the wheel @ button to select a different range. For example, if a control channel has two ranges such as gobo rotation speed from 0-50% and gobo positioning from 51%-100%, you would be locked into one of the two ranges when using the wheel. This can be useful if a fixture has lots of different control ranges on one channel.
- *Preset fader selects fixture* will cause a fixture to be automatically selected if you fade up the fader.
- *Disable Pause Snap To Next Cue* disables the function where pressing pause will snap to the next cue in the chase or cue list.
- *Access to Apply Time To Palette from any menu* allows you to set palette fade times from any menu by typing a time on the numeric keypad. If this option is unticked, this only works from the top level menu.
- *Always apply shortcut* will cause a shortcut to be applied if you have a fixture patched with a shortcut on the palette button beneath it and you press the palette/flash button in add/swop mode (rather than flashing the fixture).
- *Enable Global Quick Palette* turns on the Quick Palette function (sets a palette to all fixtures when no fixtures are selected)
- *Fixture Display Number System* sets which numbers are displayed with fixtures.
- *Return to playback state on clear*: If a playback is turned on, and you manually change some fixtures, then press Clear, the LTP channels (position etc) would normally stay where you left them after your manual changes. Turning this option on will cause LTP

channels to return to the settings programmed in the playback.

Copyright Avolites Limited 2010

## Wheel Options Tab

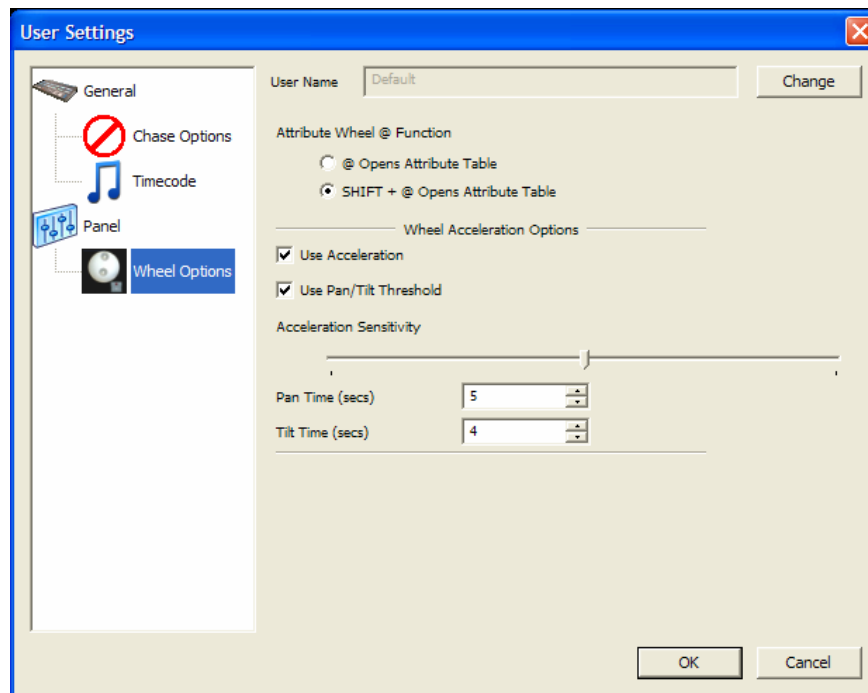

- *Attribute wheel @ function*: Lets you configure the @ button to directly open the "Select from table" function. Normally Shift+@ has this function.
- *Wheel acceleration options* let you determine how the wheels will control attributes when you spin them quickly. *Use acceleration* will cause the rate of change to increase as the wheel spins faster. The slider bar sets how much acceleration is used. *Use pan tilt threshold* limits the maximum speed for pan and tilt. The times in the boxes are the minimum time for pan/tilt to go from 0 to 100%.

### 11.1.4 Factory settings

The factory settings menu sets low-level operation of the console.

- The top drop-down box allows you to set what type of console hardware is fitted. You would only change this selection on the simulator, to simulate the correct type of console.
- The *base directory* allows you to change where the operating files and show files are stored.
- *Show heartbeat on LED*: Normally a "heartbeat" is displayed on the LED next to the back light control to indicate that the console is alive. You can turn this off if you want.
- *Log panel keypresses*: All keypresses are logged to a file on the hard disk. This enables Avolites to reconstruct what you've done, should a problem occur.
- *DMX Properties...*: Allows you to modify the timing of the DMX generated by the console, if you have problematic devices which need specific timings.

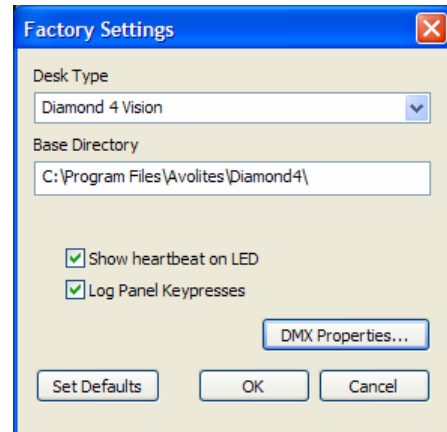

### 11.1.5 Exchange fixture

The Diamond allows you to exchange fixtures in your show for entirely different fixtures while retaining the show programming. This feature is described in section 2.7 on page 135.

### 11.1.6 Setup DMX outputs

This option allows you to setup how the 12 DMX universes produced by the console are output. This is described in detail in section 14 starting on page 228.

### 11.1.7 Hotkeys

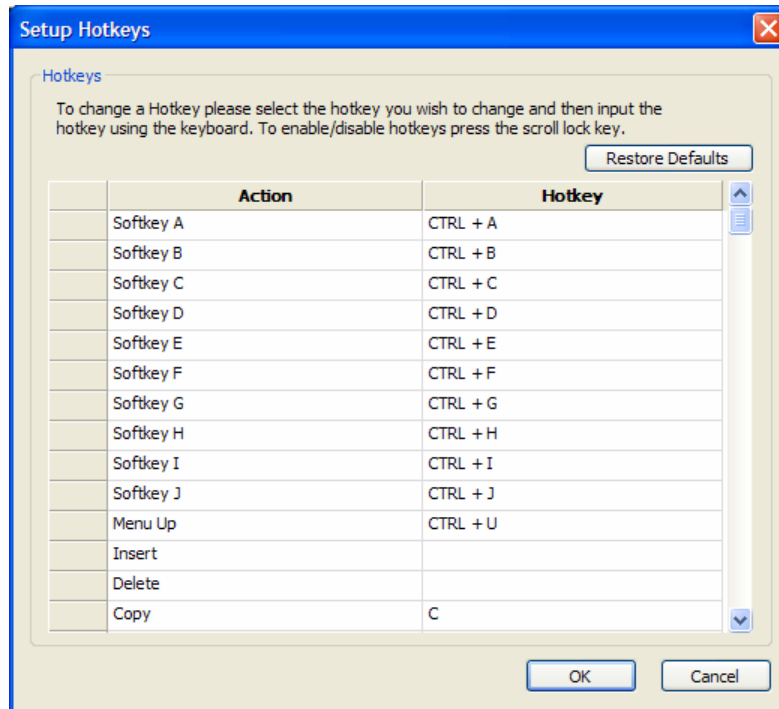

You can assign panel function keys to keys on the QWERTY keyboard using this option. This is useful when using the virtual panel, and may also be handy to customise the operation of the real console. To set or view hotkeys, click Tools, Set Hotkeys.

- Switch on scroll lock on the keyboard to enable the hotkeys feature.

## 11.2 Utilities Menu

Softkey J in the top-level Operate menu is the "Utilities" key. This brings up the utilities menu on the softkeys, which currently contains the following options:

- A [Set User Numbers]
- B [Lock Playback]
- C [Set Masters]
- D [Record Shortcut]
- E [Enable 2 Preset Mode]
- J [Enable Hardware Check]

Option [Create Patch List] has moved to the Patch menu (press blue Patch button).

[Tracking Backup Setup] and [Delay Autosave by 10 minutes] options have moved to the Setup menu (press blue Setup button).

### 11.2.1 Set User Numbers

Set User Number allows you to change the numbers assigned automatically to groups, palettes and fixtures. These numbers can be used to rapidly select fixtures or ranges of fixtures using the numeric keypad (even if the fixtures are not on the current page), and it is often handy to assign your own easily memorable numbers to them. Fixture

User Numbers can also be set from the Patch / Edit Fixture menu.

Using the Set User Numbers function:

- 
- 1> Press J [Utils]
  - 2> Press A [Set User Numbers].
  - 3> Press A [Fixtures], B [Groups] or C [Palettes].
  - 4> Enter the number you wish to use.
  - 5> Press the Swop of the Fixture, Group or Palette you wish to change
- 

In the Set User Numbers menu you can specify how the numbers increment as you change multiple items

- F [Add 1] The number will increment by one each time you apply a change, regardless of whether the next number is already in use
- G [Minus 1] The number will decrement by one each time you apply a change, regardless of whether the next number is already in use
- H [Find Next Free] The desk will find the next number that is not already in use
- I [Find Previous Free]

### 11.2.2 Lock Playback

This option allows you to lock a playback so that it appears on the same handle on every page. See section 6.2.3 on page 163.

### 11.2.3 Set Masters

The Diamond 4 does not have dedicated master faders such as Grand Master, or Playback Master. This option allows you to allocate any fader to be a master fader.

- 
- 1> Press J [Utils]
  - 2> Press C [Set Masters].
  - 3> Press A-E to select the type of master fader you want to create, or J [Delete] to remove a master from a fader.
  - 4> Press the Swop of the fader you want to set to be a master (or to remove the master from)
- 

### 11.2.4 Record shortcut

Allows you to record a panel layout shortcut which will set up the panel in a certain configuration with a single button press. See section 9.1.6 on page 199.

### 11.2.5 2 Preset Mode

If you are using a Diamond 4 Vision or Classic to control generic lights, you may wish to operate the console in "2 Preset Mode".

In this mode both the top and bottom row of faders control the same dimmer channel. Fader 65 controls the same dimmer as fader 1, fader 66 controls the same dimmer as fader 2, and so on. This allows you to set up two different lighting states and fade between them using the 2 masters that you set up on the console, as you would on a basic lighting desk.



- 
- 1> *Patch dimmers as necessary, to the bottom row of faders.*
  - 2> *Press J [Utils] on the root menu.*
  - 3> *Press B [Set Masters]*
  - 4> *Press G [Preset A Master]*
  - 5> *Press a Playback Swop to assign the A master*
  - 6> *Press H [Preset B Master]*
  - 7> *Press a Playback Swop to assign the B master*
  - 8> *Press "UP"*
  - 9> *Press C [Enable 2 Preset Mode]*
  - 10> *2 Preset Mode is now enabled*
- 

You will see that the dimmers from the bottom row of faders also appear on the top row on faders. Preset A master controls the overall intensity of the bottom row of faders, Preset B Master controls the overall intensity of the top row of faders.

With both masters at 0%, raising a preset fader will display the fader value in the LCD screens. When you then bring up the master for that fader bank, the display will invert and show the fader value multiplied by the value of its master fader. This allows the operator to easily see the levels being set ready to be faded in.

In this mode all flash buttons are disabled and if you wish to record a cue, you will need to use the record stage option.

#### **11.2.6 Enable hardware check**

This option sets the console into a diagnostic mode where the settings of all the faders are displayed on the adjacent screen. It is useful when locating faulty controls on the panel. Press J again to disable this mode.

### **11.3 Tracking Backup**

Tracking backup has been restricted to hardware only to improve system reliability. To use backup plug in the USB cables to both your consoles and transfer the show manually to the backup console. If you are using a different desk type, paste the items onto the handles, save the show and transfer the show to both desks manually.

## 11.4 Dimmer & fade curves

The Diamond provides a variety of curves which can be used for fading and also for dimmer response. The curve sets how the console tracks the fade; either the same speed all the way (linear), or starting and ending gently but faster in the middle, and various other options.

The curves are used when fading between cues (section 6.7.1 on page 167), in chases and in cue lists. They may also be applied to dimmers (section 3.1.15 on page 143) which can be useful to set channels to Relay to make them snap on and off.

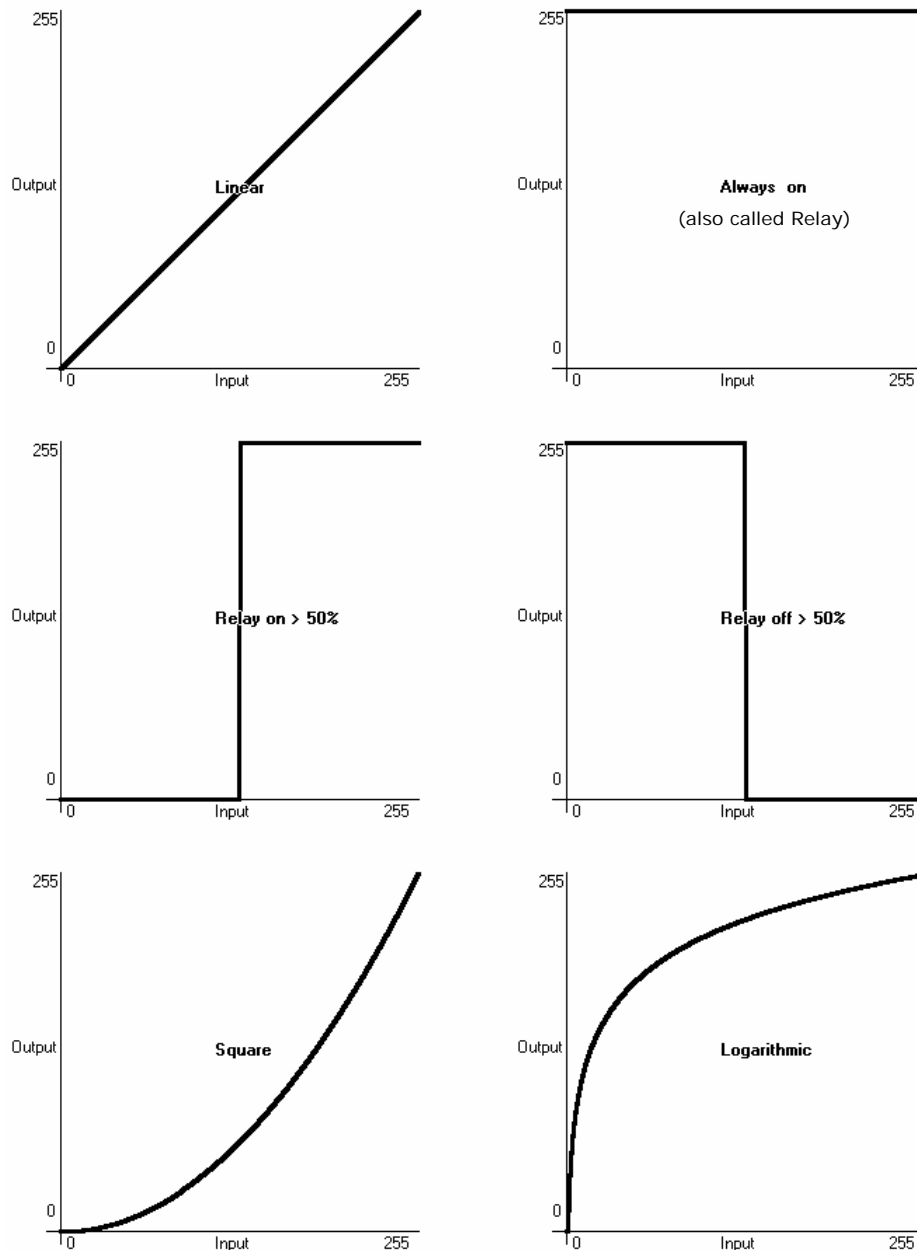

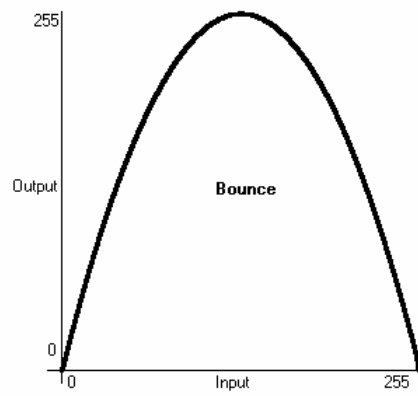
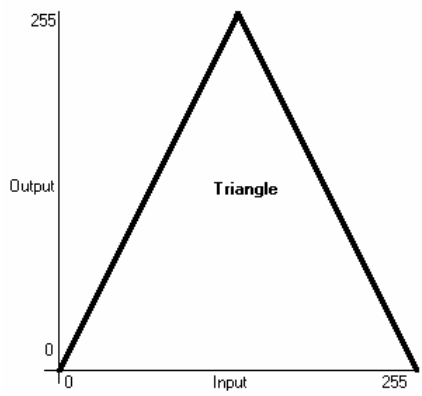
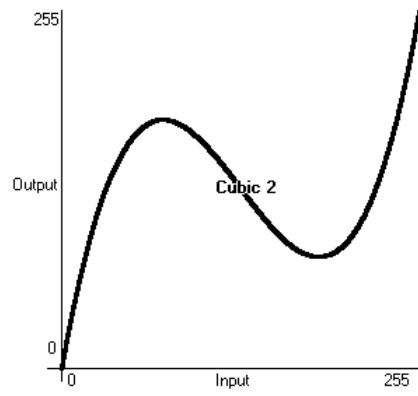
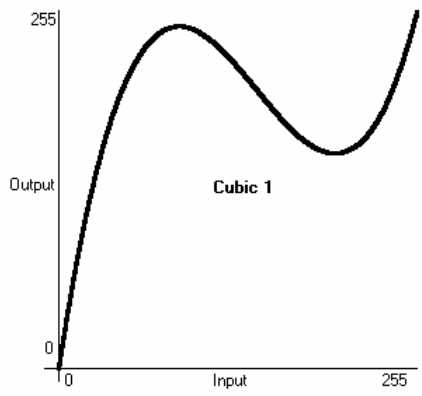
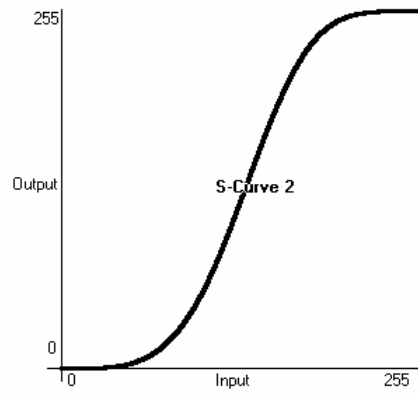
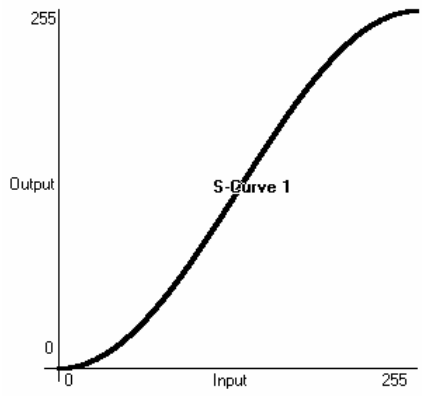
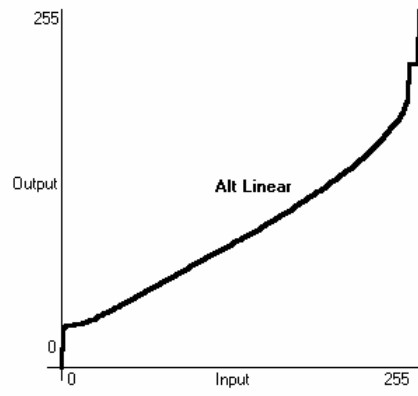
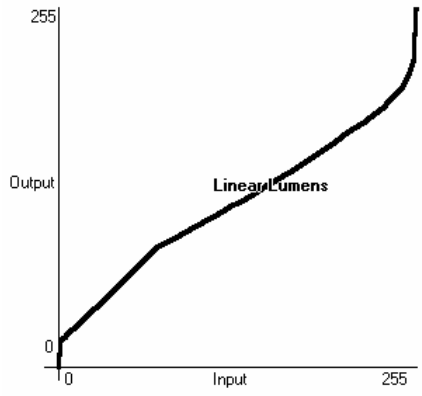

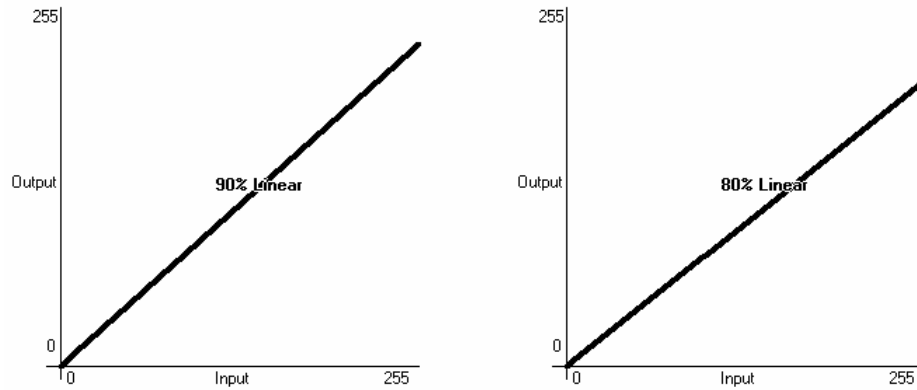

## 11.5 Upgrading the software

The Diamond 4 operating software is under constant revision by the Avolites team. You can always download the latest version of the software from the Avolites website: <http://www.avolitesdownload.com>

Having downloaded a new version of software, copy it to a CD Rom or a USB pen disk and install it on the console like this:

- 1> Copy the install file to a CD Rom or a USB pen disk.
- 2> On the console desktop, stop the D4 software using the button at the top right of the screen.
- 3> Click the View Folder button.
- 4> Navigate to where the install file is located, and double click on the file to run it.
- 5> The installer program will update the software.
- 4> Shut down the console by pressing the power switch and then restart it.

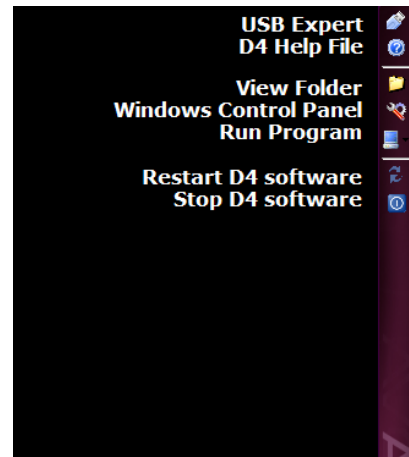

Copyright Avolites Limited 2010

## 12. Working with Fixture Personalities

For each type of fixture, the Diamond has a “personality” file which tells it how to control the fixture, which channel is the dimmer (HTP) channel, and a large amount of other fixture-specific information. When you patch each fixture, you tell the Diamond which personality to use for it.

The Diamond holds a wide range of fixture personalities internally in the “personality cache”, but you might find a fixture it doesn’t know about. This section explains what you do when this happens.

### 12.1.1 Downloading fixture personalities from Avolites

The Avolites website lists all fixtures for which personalities have been created. You should look here first if the console does not contain a personality for your fixture. The address is

<http://www.avolitesdownload.com/personalitylibrary>

Fixture Name	Desk	File Name	Name On Desk	Last Update	DMX	Disk	Cache	Details	Report Bug
Mac2000 Performance	Diamond 4	Martin_MAC 2000 Performance.D4	Mac 2000F	09/08/2004					

All available fixture personalities are listed down the left side of the screen. You can use the boxes on the top left to filter the list to show fixtures from specific manufacturers, or fixtures available for a certain console, or to search for a specific fixture name.

Click on the fixture name to open the details in the right hand window. This shows all the personalities available for that fixture type (if you have entered the console type on the top left, only personalities for that console will be displayed).

If there is a personality listed for your fixture on the Diamond 4, download it by clicking on the Disk icon. This will download a copy of

the complete personality cache.

### 12.1.2 Updating the personality cache on the console

Download the current Diamond 4 personality cache by clicking on the disk icon in the Cache column for any fixture. Alternatively you can get this file by clicking on the Download link at the top of the screen, then clicking on Diamond 4.

Then use the following procedure.

- 
- 1> *Copy the downloaded file d4personalities.exe onto a floppy disk or CD.*
  - 2> *On the VDU, click on the Start button and select My Computer.*
  - 3> *Double click on Local Disk (C:).*
  - 4> *Double click on the Avo folder.*
  - 5> *Locate the FixtureLibrary folder and click once on the folder name. Add the current date to the end of the folder name (e.g. "FixtureLibrary190105"). This stores the current fixture library as a backup in case you have any custom fixture personalities.*
  - 6> *Click the VDU start button and select My Computer again.*
  - 7> *Locate the d4personalities.exe file either on CD or floppy disk and double click on it to run it. Click "Ok" on the warning box.*
  - 8> *If you have any custom fixture personalities, copy them from your backup folder to the FixtureLibrary folder.*
  - 9> *Shut down and then restart the console.*
- 

- The Diamond 4 caches the FixtureLibrary folder when the Patch option is used. You therefore need to restart the console to ensure new fixture personalities are loaded (restarting the Diamond 4 application is sufficient).
- Once a fixture is patched, its personality is embedded in the show file. Any changes to the fixture library will not affect fixtures patched in the show.

### 12.1.3 Requesting a new fixture personality

If a personality does not exist for your fixture, Avolites will create one for you. Click on the "Request" link on the above web page to submit your request. A list of current requests is shown. Please allow 5 days for creation of the personality.

To install the personality, copy the personality file to the c:\Avo\FixtureLibrary folder on the console. Then restart the console.

### 12.1.4 Reporting a personality bug to Avolites

If you find a problem with a fixture personality, Avolites would like to know about it so it can be fixed. Click on the Bug Reports tab at the top of the window to report your problem. A list is shown of currently outstanding problems, so you can check if someone else has already reported the problem.

### 12.1.5 In an emergency

The Diamond contains a selection of "Unknown (Generic)" fixtures which you can use in an emergency if you need to operate a fixture with no personality. When patching, go through the manufacturer list until you find Unknown (Generic). In this section (among other fixtures)

are the following:

**Multi-DMX:** Has up to 10 DMX channels, all channels are LTP. You can select from 1-10 channels on the Mode screen. When patched, you control channels 1-3 on wheels 1-3, and the other channels on wheels 4-6 using the Attribute buttons to select channels 4-6, 7-9 or 10.

**Generic RGB:** Allows you to control an RGB fixture such as LED colour changers. This offers 3 modes: 1=R 2=G 3=B; 1=DIM 2=R 3=G 4=B; or RGB 4 times.

Copyright Avolites Limited 2010



Copyright Avolites Limited 2010

## 13. The Diamond 4 Pilot

The Pilot, shown at the bottom of the picture, is a hardware extension of the Diamond 4 Desktop (the Diamond 4 software running on a PC) and is used alongside a computer running the Diamond 4 software and an EzDMX DMX output box.

It provides the user with a familiar interface of faders and control buttons to help speed up both programming and playback of shows.



### 13.1.1 Connecting Up

The Pilot connects to your PC via a USB cable. Note that there is a USB hub built into the Pilot, so if you are short of USB connections, you can connect to the EzDMX box through the Pilot.



Please note that you will also need to have the Avolites D4 USB Software Dongle installed.

Ensure you are running Version 1.5 or later of the Diamond Software.

With the Boxes connected, turn on the pilot and follow the on-screen instructions. If you installed earlier versions of the Diamond software, you may be asked to choose between different drivers. If this is the case, please select the most recent driver.

### 13.1.2 Layout

On the left hand side of the Pilot are eight "flying" faders, each with Go, Flash and Swop buttons. Each of these buttons also has a Shift function. The Go buttons can act as "Connect" buttons, the Flash as "Back" and the Swop as "Release" buttons.

To the right of the faders is the control area. At the top is the "Set Button Mode" key. This has 2 functions. Firstly, by holding the button down, the fader controls can be used to change fader bank. Second, if pressed in conjunction with the "Shift" button, it toggles the D4 between Fixture and Add/Swop mode.

The wheel directly controls the 1st cue list control wheel. Next to this are the page buttons. The LEDs indicate which type of page is selected (Preset, Palette or Cue) and they can be used to step through pages as required.

Finally, below the wheel are Cue List/Chase control buttons that control the currently connected playback, and the Shift/Connect key.

### 13.1.3 Operating

When the system starts up initially, the faders will be set to control the first bank of Playback faders, (Playbacks 1 - 7). Raising a fader on the Pilot will cause the same fader on the virtual panel to move, and vice versa. If you have any Cues, Lists or Chases recorded to these faders, you will be able to immediately control them from the Pilot.

It is easy to assign the faders to any bank of faders on either a D4 Vision or Elite virtual panel. The banks are selected using the special "Set Button Mode" in combination with the Go, Flash and Swop keys on the Pilot.

These are the 3 rows of buttons above and below the faders. The top row corresponds to the top row of presets, the middle row to the bottom row of presets and the bottom row, below the faders, corresponds to the Playbacks. So to select the second bank of playbacks, you would press and hold the "Set Button Mode" key then press the second fader's "Go" button.

To change the fader bank:

- 
- 1> *Press and hold the blue "Set Button Mode" key.*
  - 2> *Press the Go, Flash or Swop button that corresponds to the required bank.*
- 

To change the page that you are currently working from, First select whether you wish to change the Cue, Palette or Preset page. This is done by holding down the shift key, then pressing the relevant page button on the right hand side of the Pilot. The LED of the currently selected page type will light up. You can then use the buttons as + and - buttons to step through the pages.

To change page:

- 
- 1> *Press and hold the blue Shift key.*
  - 2> *Press the Preset, Palette or Cue button that corresponds to the required page type*
  - 3> *Use the + and - buttons to step through the pages.*
- 

To change between Fixture and Add/Swop Mode, Press and hold the "Shift" key and press the "Set Button Mode" key

To connect and control a Cue List or Chase from the wheel and associated controls, press and hold the Shift (Connect) Button, then press the "Go" button of a fader that has a Cue List/Chase recorded to it. You can then control the chase speed from the Wheel, and use the Go, Pause and reverse buttons as you would on the console itself.

To release a Cue, Chase or Cue List

Hold the "Shift" key and press the Blue "Swop" key above the fader you wish to release. This will release the playback in the same way as pressing Shift-Swop on the console

## 14. Networking

*This chapter contains; Connecting to a Simulator with ACDI; Connecting to fixtures with ArtNet, eDMX and EzDMX; AvoTalk; explanation of IP addressing.*

There are a number of ways for the Diamond to communicate with lighting fixtures beyond the traditional DMX sockets on the back of the console, which are described in this chapter. The Diamond also supports communicating with a number of different simulators/visualisers over various communication methods.

At the end of the chapter is a section which aims to cover the basics of IP addressing, which is essential for various features on the Diamond such as Tracking backup and ArtNet.

**Note:** Lighting networks need to transfer of large amounts of data. For best reliability you should use network wiring which is dedicated to the lighting system and physically isolated from other networks. Connecting to an existing network with other network traffic is possible but can lead to problems both with the lighting equipment and with other IT equipment on the network. If you need to do this please read about the IP addresses you should use, in section 14.9.5.

### 14.1 Setting the Diamond's IP address

Before the Diamond can talk to another device over the network, it has to be given a unique network address. This is called its "IP address". The Diamond's IP address can be quickly set using the Network menu option.

#### 14.1.1 Setting IP address from the setup menu

The Network Setting option allows quick setting of the console's IP address. You can set either of the valid Art-Net address ranges of 2.x.x.x or 10.x.x.x.

- 1> *On the Diamond front panel, press the blue Setup button, then I [Network].*
- 2> *Press B [Network Settings]*
- 3> *Press A [Set IP address 2.\*.\*.\*] to set the Diamond's IP address to a free address within the range 2.x.x.x, or B [Set IP address 10.\*.\*.\*] to set the Diamond's IP address to a free address within the range 10.x.x.x*
- 4> *Press Shift + Up. The top line of the left hand softkey display will now show the console's IP address.*

The other options on the Network Settings menu are

D [Get IP address automatically] will check for a DHCP server on the network, and if found, will obtain an IP address from it.

E [Set manual IP address] allows you to manually enter the desired IP address, subnet mask, default gateway and DNS server addresses. This option is for advanced users only, in most situations softkeys A or B will work.

## 14.2 Setting up DMX outputs

The Diamond has 12 DMX lines which can be routed to the DMX sockets on the rear of the console (see section 2.6.4 on page 134), and can be sent out over the Diamond's Ethernet socket. The Setup DMX Outputs screen lets you determine where the DMX lines are routed to. Click Options then Setup DMX Outputs on the Diamond's VDU menu to show the screen.

### 14.2.1 Setup DMX outputs screen

On the left hand side of the screen, the 12 DMX lines generated by the Diamond are shown (in this window they are numbered 1-12, on the console displays when patching they are lettered A-L). On the right hand side is a list of nodes where the DMX can be routed to.

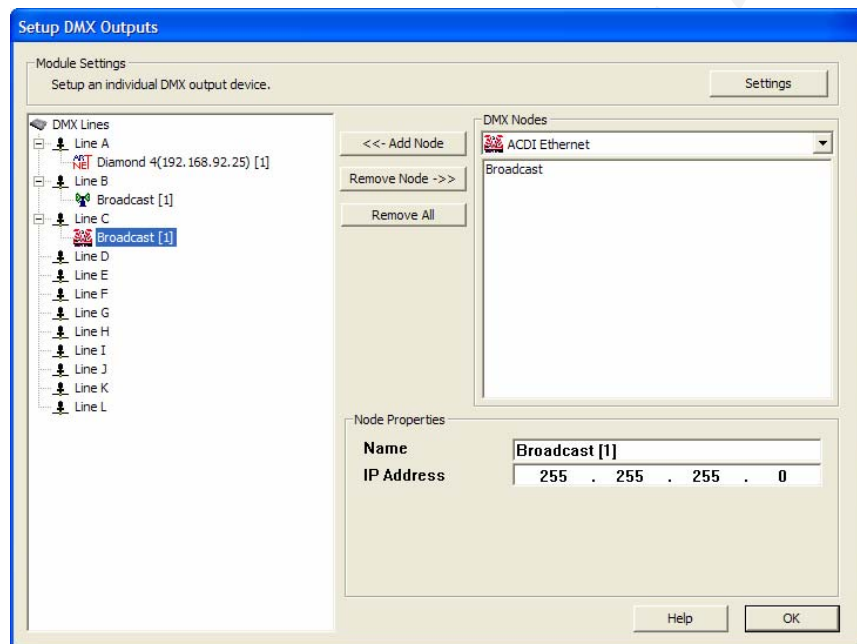

As an example we will add an ACDI node to DMX Line 1.

- 1> On the VDU menu, click on Tools, Setup DMX Outputs.
- 2> Click on Settings
- 3> Select the ACDI module.
- 4> Ensure that the correct Network adapter is set (this may not be the Default Adapter) and the Enable DMX Output box is ticked
- 5> Click OK
- 6> In the left panel, select a DMX line for the simulator
- 7> In the right panel, select the ACDI Ethernet node that you want to connect to
- 8> Click on Add Node. This will add an ACDI node to that DMX output
- 9> On the left hand side, select the node you have added. The node properties will be shown in the panel on the bottom right of the window

- To remove a node from a DMX line, select the node (i.e. Broadcast 2) and click Remove Node.
- Each DMX line can be sent to multiple nodes (this will effectively create a duplicate DMX universe). However you must ensure that you do not send more than one DMX line to a single node, as this

can cause problems.

## 14.3 Connecting to a simulator with ACDI

ACDI is Avolites' Application for Interfacing Consoles and Simulators with lighting software such as Visualiser, Capture or Show designer.

### 14.3.1 ACDI

If you are using the Diamond Simulator with the Avolites Visualiser, running on 2 separate computers, you will need a separate Dongle connected to each computer.

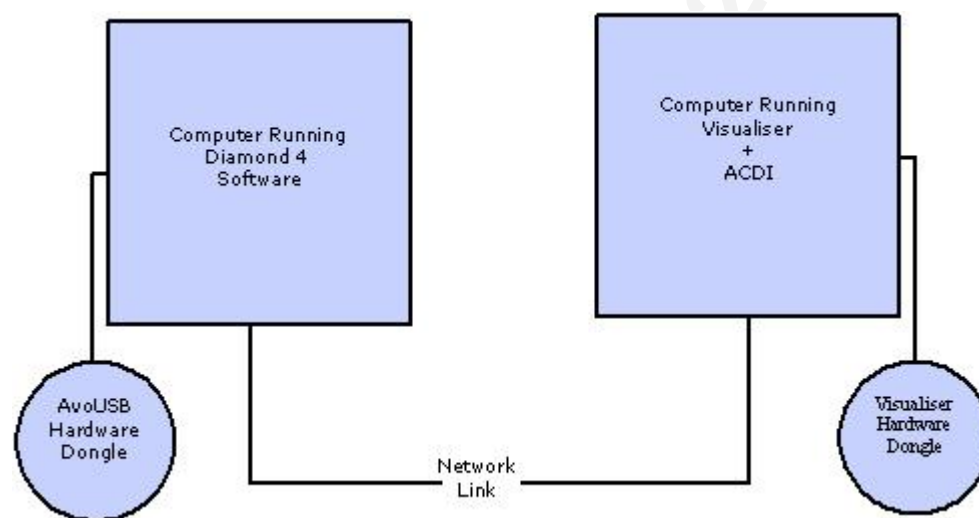

The network link connection can be made through either a crossover cable, or through a network hub.

For this example, both computers are connected together via a crossover cable.

First, we will set up the Network setting for both computers. It is important that both computers use an IP address in the same range (2.0.0.x in this example) and have the same subnet mask, or they won't be able to communicate.

On the Diamond, set the address to 2.x.x.x as described in section 14.1.1 at the start of this chapter. If you need to set a custom address to match the visualiser PC you can use Control Panel to do this.

On the computer running the Visualiser:

- 
- 1> Click Start, Control panel, Network connections.
  - 2> Right click on the connection you wish to use.
  - 3> Click Properties.
  - 4> In the connection properties window select TCP/IP and click Properties
  - 5> Set the PC network adapter to a free address on the network in the range 2.0.0.x.
  - 6> Set the subnet mask to 255.0.0.0.
  - 7> Click OK.
- 

Close any network windows on both machines.

Install and run ACDI on the Visualiser Computer.

In ACDI change "Source" to "Simulator"

Do not close the ACDI window

Refer to the previous section, 14.2.1, to setup a DMX line on the Diamond to be sent to the Visualiser.

Finally, start the Diamond, and open or create the theatre file. (See the Visualiser manual for more information on this)

Once ready to connect to the Diamond, go to run mode in the Visualiser, and select simulator under DMX.

The Diamond should now be working with the Visualiser.

## 14.4 ArtNet

Art Net is an open standard for transmitting Lighting information over Ethernet. It is not specific to one range of products, and is recognised and implemented by a growing number of manufacturers. Many products (such as Dimmers and Moving lights) can accept the Art Net signal directly, so there is no need to convert the signal to DMX. Most people will, however, need to output DMX to their equipment and this can be done using an Art Net to DMX converter.

### 14.4.1 A simple ArtNet system

In the following diagram, an Art Net compliant Console (such as the Diamond 4) is connected via a network hub to an Art Net compatible dimmer and 2 DMX conversion boxes.

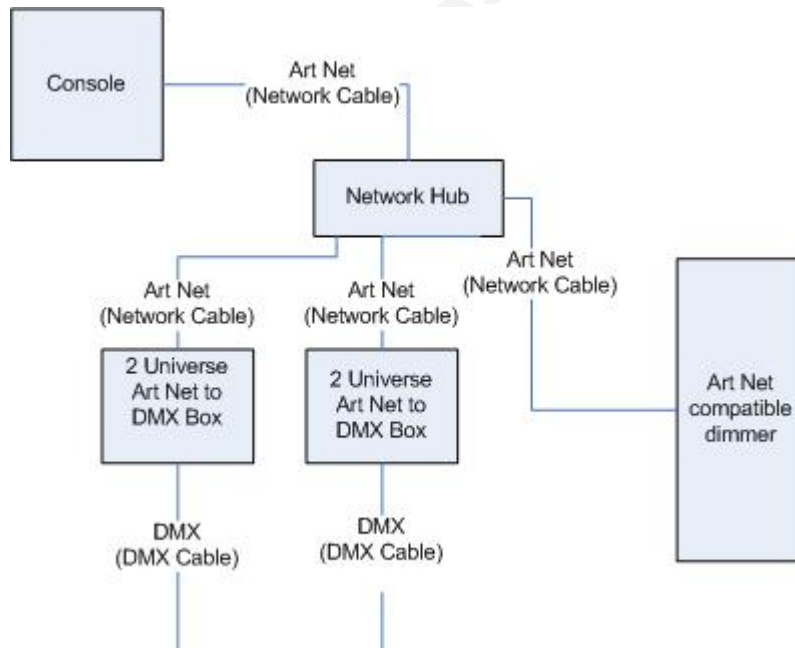

Once the system is connected together, the different outputs (or Nodes) can be configured.

- The dimmer is given the start address of 200
- The 1st DMX box is set to universe 1 and universe 2
- The 2nd DMX box is also set to universe 1 and universe 2

The console is then used to set the DMX lines to the Art Net nodes.

It is important to remember:

- Each Art Net to DMX box (or compatible Dimmer, or compatible moving light) is a device,
- Each device may have one or more nodes(i.e. the Art Net to DMX box has 2 nodes, these are the 2 DMX outputs; the dimmer itself is a node),
- Each node can be set to a Universe (1-256). This universe is equivalent to a 512 channel DMX line

You can then specify which console line is assigned to each node. A console line can be assigned to multiple nodes (this will duplicate the DMX universe), but each node should have only one console line assigned to it.

Here, the console assigns the following:

- Line A to Box 1 universe 1 and box 2 universe 1
- Line B to Box 1 universe 2
- Line C to Box 2 universe 2 and the dimmer rack

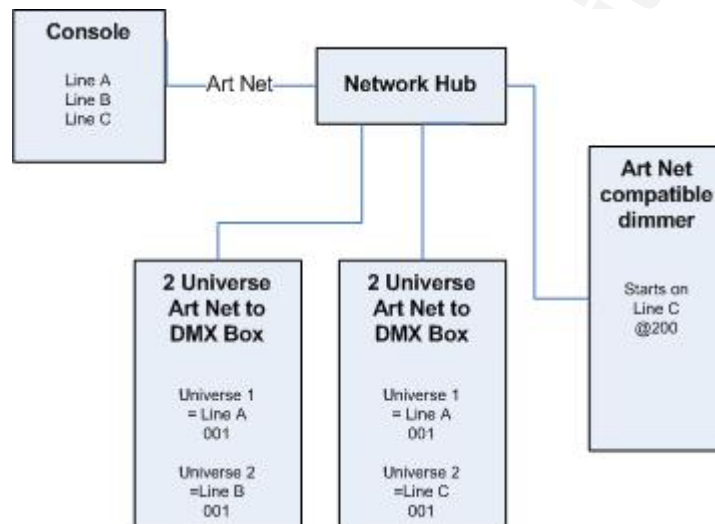

#### 14.4.2 Setting up an ArtNet system

For this example, it is assumed that you will connect the Diamond to an Art Net DMX output box (such as an Artistic License Net-Lynx) via a network hub.

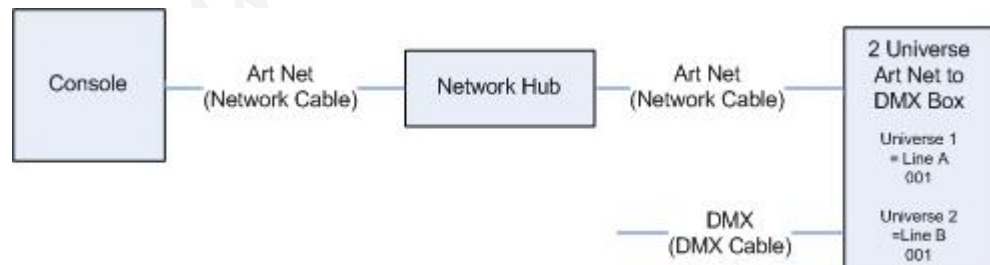

Using standard network cables, attach the devices together.

- If you are using a hub/switch as shown above, use straight-through cables. If you are directly connecting the D4 to another Ethernet device you need to use crossover cables

Set the Net-Lynx box as follows:

- Subnet Mask = 0



- DMX A Universe = 1
- DMX B Universe = 2

A lot of Art-Net devices, including the Net-Lynx box, are set to IP address 2.x.x.x as default, and can be set to 10.x.x.x using an option jumper, so you should check what the setting of your device is.

If your ArtNet devices need to be set to a non-standard IP address, then in steps 1 and 2 you need to use Windows Control Panel to set the Diamond to that address range instead of 2.x.x.x

With everything connected, start the Diamond.

- 
- 1> *Set the Diamond's IP address to an address within the range 2.x.x.x as described in section 14.1.1 at the start of this chapter, which will enable it to talk to the Net-Lynx boxes.*
  - 2> *On the Diamond VDU, click on Tools, Setup DMX outputs.*
  - 3> *Click on settings*
  - 4> *Select the ArtNet module. If the module is not shown in the list, it may not be installed; see section 14.7 on page 237.*
  - 5> *Ensure that the correct Network adapter is set (this may not be the Default Adapter)*
  - 6> *If you wish to turn off the Art Net output, you can un-check the "Enable DMX output" option. This will stop the Console from outputting Art Net on any Lines.*
  - 7> *Art Net normally only sends Data when it is changed, rather than a continuous stream. There are times when it is preferable to send Art Net all the time. to do this, check the "Continuous ArtNet Data Stream" option.*
  - 8> *The "Always broadcast ArtNet" option enables you to send Art Net to the entire network, rather than a specific IP address.*
  - 9> *Click OK*
  - 10> *If you are using a non-ArtNet-standard IP address you will get the Art Net IP address warning, Click Ignore. (Clicking OK will alter your network settings to be Art Net compatible, erasing any changes you may have made.)*
  - 11> *Select a DMX line for the Diamond 4*
  - 12> *Select the ArtNet node that you want to connect to*
  - 13> *Click on Add Node. This will add an ArtNet node to that DMX output.*
  - 14> *Select the node you have added to make sure the properties are correct. (Problems can be caused if you attach multiple DMX lines to a single node.)*
  - 15> *Make sure that the Universe is set to 1 for Line 1, and 2 for Line 2.*  
*Art-Net uses a subnet mask with its universe. For Diamond purposes:*  
*Diamond universes 1 - 16 are subnet mask = 0, Art-Net universes = 1 - 16,*  
*Diamond universes 17 - 32 are subnet mask = 1, Art-Net universes = 1 - 16, and so on.*
  - 16> *Click OK*
- 

The Diamond 4 should now be working correctly.

To remove a node from a DMX line, select the node and select Remove Node.

### 14.4.3 ArtNet IP Address Warning

The Art Net standard requires that all devices wishing to connect to an Art Net should use an IP Address that is specific to that device. This reduces the risk of devices having conflicting IP Addresses, which would result in the device not working.

The Art Net standard also states that the first part of the IP Address should be 2 or 10.

This warning is displayed when the IP Address of your Network Adapter does not match any of the required IP Addresses in the standard.

#### Artnet Compatible IP Addresses

There are two types of compatible IP addresses 2.x.x.x or 10.x.x.x. You must decide on which type you wish to use when setting up the network.

Once you have made this choice, each device will fill in the x and assign its IP Address automatically. The device should calculate its IP Address using its own manufacturer code and the network devices MAC address.

#### Recommended Action

To ensure that this console works correctly on your Art Net it is recommended that you select either of the two options 2.?.?.? or 10.?.?.? and click OK. This will then calculate a compatible Art Net IP Address and setup your network settings correctly.

If you have more than one Network Adapter then the new settings will only affect the network adapter you chose for Art Net.

- If the Network Adapter is already configured for a different network then the new settings may prevent that network from functioning correctly.

### 14.4.4 Additional ArtNet Resources

To find out more information about Art Net please refer to the Art Net Standard published by [Artistic Licence](#).

## 14.5 eDmx

eDmx is an Avolites product for transmitting DMX wirelessly over Ethernet. It consists of Encoder and Decoder "tubes" and is able to convert DMX to Ethernet, transmit the signal and convert it back to DMX, regardless of the console being used.

When used with the Diamond, you can connect your PC directly to the tubes through a wireless network adapter, or wireless access point.

In the following diagram, a console is connected directly to an eDmx Encoder and DMX data is transmitted wirelessly to an eDmx Decoder.

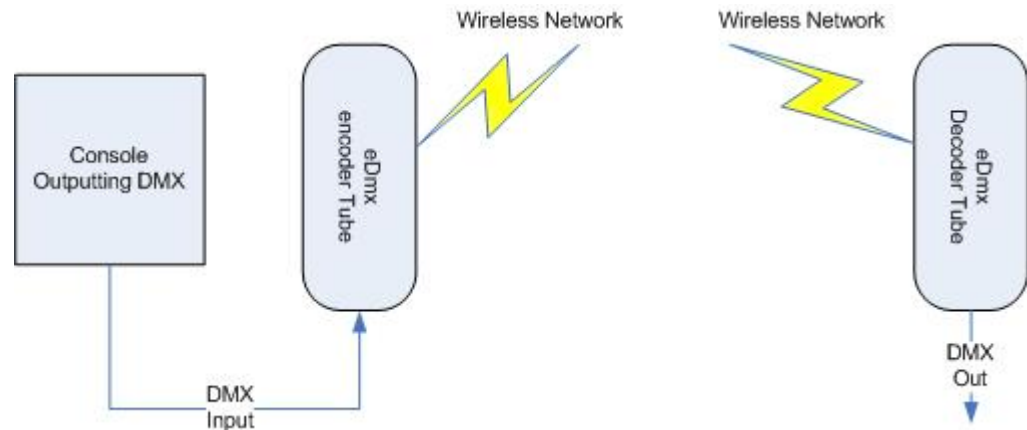

Connection from a PC would look like this:

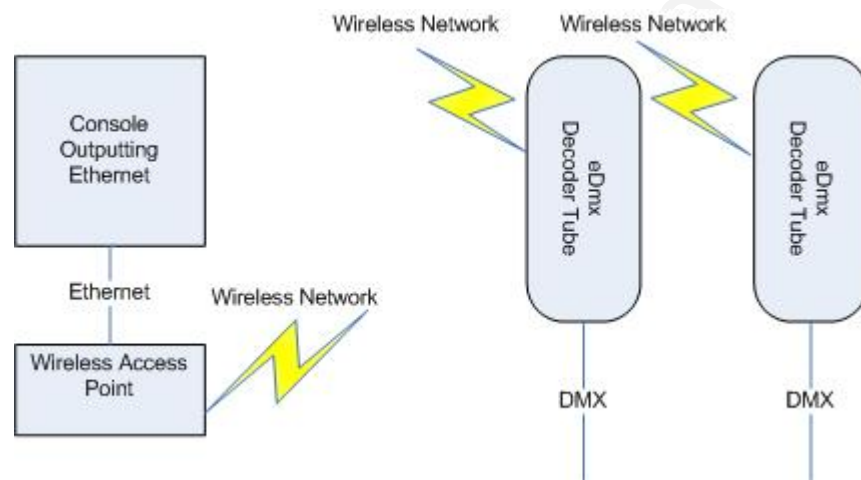

### 14.5.1 Setting up eDmx with Diamond 4

We will set up a system with one Diamond, a Wireless access point, and one eDmx Decoder Tube.

First we need to set up the decoder tube. Please refer to the eDMX user manual for further information on setup.

Ensure that the following settings are correct:

- **SSID** This is the Wireless networks SSID or name, it must be the same as the Wireless Access Point and all other Tubes on the same network for every device to function accordingly. The default SSID is "avolites" (note that this is all lower case)
- **IP Address** This is the IP address of the unit. One of the benefits of the eDMX system is that it utilises full IP addresses which enable the routing of the eDMX data across all kinds of switched and unswitched networks. For this example we can use 2.0.0.71; if you have multiple Decoder Tubes, each has to have a unique IP address in the same range i.e. 2.0.0.x. Each unit must also have a subnet mask of 255.0.0.0.
- **Wendi Universe** Set the Wendi universe to 1.

You will also need to set up the SSID, IP address and subnet mask of the Wireless Access Point to match what you have set on the tube(s). Again the device has to have a unique IP address in the same range as the tubes. Setup of the Wireless Access Point is usually performed using a web browser from a PC (or can be done using a web browser on the

D4 console desktop). Please refer to the Wireless Access Point user manual for information on how to do this.

Connect the Diamond to the wireless access point (or Wireless card) and set the Diamond's IP address to an address within the range 2.x.x.x which will enable it to talk to the eDMX devices, as described in section 14.1.1 at the start of this chapter.

On the Diamond 4, set up which DMX line(s) you want to send:

- 
- 1> *On the Diamond4 application screen menu, click on Tools, Setup DMX outputs.*
  - 2> *Click on settings*
  - 3> *Select the eDmx module. If the module is not shown in the list, it may not be installed; see section 14.7 on page 237.*
  - 4> *Ensure that the correct Network adapter is set (this may not be the Default Adapter)*
  - 5> *Click OK*
  - 6> *If you are using a non-standard IP address, you will get the Art Net IP address warning. Click Ignore. (Clicking OK will alter your network settings to be Art Net compatible, erasing any changes you may have made.)*
  - 7> *Select a DMX line to be sent to the node*
  - 8> *Select the eDmx Broadcast node.*
  - 9> *Click on Add Node. This will add an eDMX node to that DMX line.*
  - 10> *In the DMX lines list, click on the node you just added to make sure the properties are correct. (Problems can be caused if you attach the same node to multiple DMX lines.)*
  - 11> *Click OK*
- 

The Diamond 4 should now be working correctly and DMX data from the console should be coming out of the Decoder Tube(s). In some circumstances you may need to restart the Diamond 4 before all settings take effect.

To remove a node from a DMX line, select the node and click Remove Node.

## 14.6 EzDmx

EzDMX is Avolites USB to DMX box. It is designed to be used with the Avolites simulators and not a physical Diamond 4 console.

The output is automatically set once the box is connected in the following manner for the diamond Simulator. Note that lines 1-8 are called A-H when patching.

- Node 1 = DMX Line 1
- Node 2 = DMX Line 2
- Node 3 = DMX Line 3
- Node 4 = DMX Line 4
- Node 5 = DMX Line 5
- Node 6 = DMX Line 6
- Node 7 = DMX Line 7
- Node 8 = DMX Line 8

The EzDMX box also allows the use of MIDI in and MIDI out for the simulator, enabling you to control the simulator from other midi devices.

## 14.7 Module Setup

A module is a method of sending DMX and can be thought of as a collection of nodes.

For example, eDmx uses wireless networking technology to transmit DMX to several individual tubes. Each tube is configured to output a specific universe of DMX. In this case, the eDmx system as a whole is the module, and each tube is a node.

In the case of EzDMX, each USB box is a module, and each DMX output on the box is a node. Nodes 1-8 are preset to the Diamond Simulator lines 1-8 as explained in the previous section.

The Module Settings window (top right of the Setup DMX Outputs screen) enables you to set the specific properties of the Modules used with the Diamond. These were selected during the installation process. If you are running the Diamond simulator, some (or all) modules may be missing, depending on what D4/Avolites hardware you have attached.

You can only use different modules (i.e. Art Net and eDmx) if you have several network adapters, or by re-configuring the IP addresses of the Devices to be compatible.

In the Setup DMX Modules window, click on the Module that you wish to adjust, and its properties will be shown.

This allows you to adjust settings for each module, and to select a network adapter for ACDI, Art-Net and eDmx. Most people will only have one network adapter, however many laptop users will have their standard network adapter and also a WiFi (wireless) adapter, both of which will be shown.

### 14.7.1 Installing additional Modules

If the DMX Module that you want to use has not been installed, you can add it by running the Diamond 4 installer again and checking the option(s) that you want in the setup window.

## 14.8 AvoTalk

AvoTalk allows devices on a standard network to communicate and share information. In the case of Avolites consoles it allows the console to talk to fixtures and to retrieve and change information such as personalities and Mode information.

For example, when using a media server such as Hippotiser with the D4 you have the option of patching it as an "active fixture". In order for this to work you must download and install an "Active Fixture Plugin" for the device you want to use and install that plugin on the device (i.e. the Hippotiser). When the plugin is run on the active device, it interrogates the device and generates a personality and other information specific to that device such as media thumbnail clips, and provides this info to the D4 over the network using the AvoTalk protocol. These thumbnails, for example, can then be used in the

wheel view on the D4 to provide a preview of the media selected on a particular media layer.

Active fixtures can also perform other tasks such as readdressing themselves to a new DMX universe or DMX address etc and all these tasks are performed by sending commands using AvoTalk across the network.

AvoTalk is designed to work alongside other lighting protocols such as eDMX or ArtNet. Once a network connection is established AvoTalk will detect any compatible devices and start talking.

### 14.8.1 Example AvoTalk setup

We will look at setting up a Green Hippo Hippotiser with the Diamond 4 using a combination of AvoTalk and ArtNet.

You will need the following:

- Diamond 4 with Software Version 1.5 (or greater)
- Green Hippo Hippotiser
- AvoTalk Hippo Plugin
- Crossover cable

- 1> *Turn on the Diamond 4 and the Hippotiser. For this example we assume you have performed a wipeall on the Diamond.*
- 2> *Connect the Diamond and the Hippotiser together using the crossover cable. Note that there may be a cable already connected to the network port on the Hippotiser that comes from within the unit. This is connected to the DMX box on the front, and can be disconnected.*
- 3> *Set up the Diamond for ArtNet. Go to Tools / Setup DMX Outputs, click on settings, then select ArtNet. Set the adapter if necessary, then click OK. The ArtNet IP warning will appear. Make sure that "2.x.x.x" is selected then click OK.*  
*For more information on the DMX Modules, see Chapter 3 on DMX outputs.*  
*At the moment you don't need to add any nodes, so click OK to close the Setup DMX Outputs window.*
- 4> *Install the AvoTalk Hippo Plugin on the Hippotiser, but don't run it just yet. The Hippotiser software should not yet be running either.*
- 5> *Using the Stage Settings application, set up the Hippotiser to run in the preferred mode (please refer to the Hippotiser manual for further information).*
- 6> *Run the Hippo Plugin on the Hippotiser. Click on "Set network adapter" and set the adapter, then click on "Detect Hippotiser Layers". The plugin will now look for all of the media files and setup of the Hippotiser. Please note that this may take some time, depending on the number of clips that are available. If you receive the message "No Hippotiser available" ensure that the Hippotiser is enabled.*
- 7> *On the Diamond, go to Patch / Active fixture and select "Hippo (Ser.No.)". In this case the Active Device is called Hippo 15. If there are no active devices found, try exiting the menu and waiting for a few moments before trying again (there can be a short delay while the media clips are examined by the plugin).*
- 8> *On the Diamond, enter a DMX address and press a swop button to*

*patch the Hippotiser. The required number of fixtures will be patched to consecutive handles, and the Hippotiser DMX address will be assigned to the one entered on the Diamond.*

- 9> *Now run the Stage application on the Hippotiser. **DO NOT CLOSE THE PLUGIN.***
- 10> *Finally, on the Diamond, go to Setup DMX Outputs and you will see the Hippotiser appear as a Node. Add this to the required DMX line. Again, there may be a slight delay before the Hippotiser node appears.*

---

Once the Hippo Plugin is installed, it will automatically start every time the Hippotiser is started. If you change the Hippotiser mode, you will need to go to the Hippo Plugin, re-detect the Hippotiser and re-start the Diamond.

If you disconnect the network cable you will need to go to the Hippo Plugin, re-detect the Hippotiser and re-patch the Diamond.

If you decide to re-patch to a different DMX address you will need to re-start the Hippotiser software. You will also need to reset the ArtNet nodes if you are moving across DMX lines.

## 14.9 All about IP addressing

This section attempts to explain the basics of IP addressing, and what you will need to know when setting up a lighting control network.

IP addresses will normally come in the format "w.x.y.z" where w, x, y and z are numbers between 0 and 255. For example "298.23.46.166". Every object (or node or device) on a network should have a unique IP address. This is the same concept as DMX as each fixture requires a unique DMX address, for IP addresses the same is required.

### 14.9.1 Setting your IP address

See section 14.1.1 at the start of this chapter for details of how to set the Diamond's IP address using the console buttons.

You can also set your IP address in the same way you would on a Windows XP computer. This is done in the following way:

- 
- 1> *Go to the control panel (click the spanner icon on the top right of the VDU, or if you have a green Start button click Start then Control Panel)*
  - 2> *Double Click on Network Connections*
  - 3> *Right click on the Local Area Connection icon and select Properties. If there is more than one connection you will need to identify which one you are using for the console output – if it's disconnected the icon will normally have a red cross.*

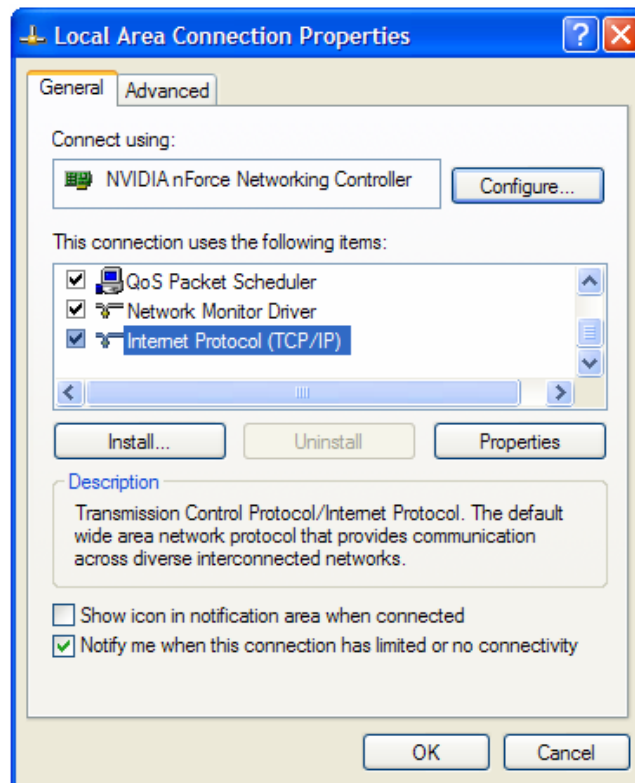

- 4> Select the item called "Internet Protocol (TCP/IP)" ensure this is ticked and click on "Properties" just below the selection box.

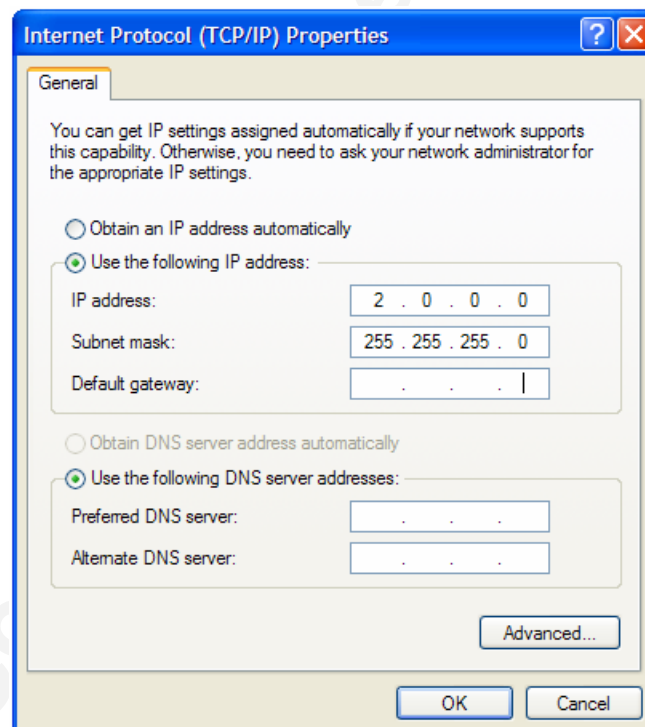

- 5> Click the "Use the following IP address" button and enter the IP address and Subnet mask as (in this example) 2.0.0.0 and 255.255.255.0 The Default gateway, Preferred DNS server and Alternate DNS server and not important in this situation as they are only required if you are connecting to the internet, therefore they can be left blank.



6> *Once you have entered in the new IP address and Subnet mask press Ok on all the dialogue boxes that have been opened. After a few moments your new IP address should be set.*

There is a strong possibility that if you set the IP address on one network device you will have to set it on all of them, therefore if you manually set your IP address on the Diamond 4 you will have to do it on any tracking backup you are using and any ArtNet fixtures. Beware that some ArtNet fixtures have a fixed IP address in the range 2.x.x.x, in which case you have to set the D4 to that range.

### 14.9.2 Subnet Masks

These are best kept simple. All devices or nodes on a network who wish to communicate with each other must have the same subnet mask. The mask determines which parts of the IP address are unique in that network to each node. If the part of the subnet mask is a 0 then the corresponding digit in an IP address must be unique for each fixture. If the part in a subnet mask is 255 then this part of the IP address needs to be the same for each node.

### 14.9.3 Choosing an IP address and Subnet Mask

This is the hardest part of setting up a network as your IP address totally depends on what you are using on the network and what IP addresses you can and cannot change. Below are a number of different scenarios for standard lighting networks using a Diamond and what IP addresses should be set. These aren't guaranteed to work but try them if the scenario matches your network:

#### **Diamond 4 and ShowSafe, all output is standard DMX.**

	IP Address	Subnet Mask
Diamond 4	192.168.1.30	255.255.255.0
ShowSafe	192.168.1.31	255.255.255.0

#### **Diamond 4 outputting over ArtNet Fixtures (and DMX).**

	IP Address	Subnet Mask
Diamond 4	2.100.100.100	255.0.0.0
ArtNet Fixtures	2.x.y.z	255.0.0.0

Or

	IP Address	Subnet Mask
Diamond 4	10.100.100.100	255.0.0.0
ArtNet Fixtures	10.x.y.z	255.0.0.0

Where a combination of x, y and z are unique for these fixtures.

#### **Diamond 4 and ShowSafe outputting over ArtNet (and DMX).**

	IP Address	Subnet Mask
Diamond 4	2.100.100.100	255.0.0.0
ShowSafe	2.100.100.101	255.0.0.0
ArtNet Fixtures	2.x.y.z	255.0.0.0

Or

	IP Address	Subnet Mask
Diamond 4	10.100.100.100	255.0.0.0
ShowSafe	10.100.100.101	255.0.0.0
ArtNet Fixtures	10.x.y.z	255.0.0.0

Where a combination of x, y and z are unique for these fixtures.

**Note:** Never set the last number of an IP address to be 255. This is a special address which will not function how you expect it to.

#### 14.9.4 Automatically assigning IP addresses (DHCP)

There is another way of assigning IP addresses via an automatic system called DHCP. For this you need one of the devices on the network to be a DHCP server. If you know none of your devices are a DHCP server then this is irrelevant however, if you have a router on the network or some such similar device then it is likely that you have a DHCP server. If you do then in the 8 step instructions in section 14.9.1 on page 239 when you come to step 7 you should ensure that "Obtain an IP address automatically" is selected then press ok. When you are using DHCP all the devices on the network must be capable of obtaining an IP address automatically. If one device cannot (eg some ArtNet devices) then you must manually set all the IP addresses.

#### 14.9.5 Private IP address ranges

If your network is connected to the internet it is important to use a private IP address range. These are special IP addresses that will not be routed onto the internet. They are:

Start Address	Final Address	Subnet Mask
10.0.0.0	10.255.255.255	255.0.0.0
172.16.0.0	172.31.255.255	255.255.0.0
192.168.0.0	192.168.255.255	255.255.255.0

For Art-Net, the 10.x.x.x range must be used.

#### 14.9.6 Ping

Ping is an Ethernet protocol used to test response from other devices on the network. The D4 includes a ping function which can be useful to check connection to DMX nodes on the network.

- 
- 1> *Press the blue Setup button then I [Network]*
  - 2> *Press J [Ping]*
  - 3> *Enter the IP address of the node you want to test, for example 2.0.0.5*
  - 4> *Press Enter.*
  - 5> *If a reply is received from the node, a message will be shown on the top line of the right hand display.*
  - 6> *Press Shift and Up to exit.*
- 

## 14.10 Repairing a Network Connection

If you are sure your network connection settings are correct or had

them working but they are no longer working it may be necessary to repair the network connection. This is a simple windows function that can be accessed by doing the following:

- 
- 1> *Go to the control panel (Start->Control Panel)*
  - 2> *Double Click on Network Connections*
  - 3> *Double Click on the Network Connection you would like to repair*
  - 4> *Click on the Support tab.*
  - 5> *Click Repair.*
- 

Windows will complete a number of tasks and give you a message informing you it has finished repairing the connection. Click close then ok to all the open windows.

Copyright Avolites Limited 2010

---

## 15. Glossary of terms

ADDRESSES	The DMX Channels occupied by individual Fixtures. The first Channel occupied is usually encoded onto the Fixture somehow (often by switches or using a menu) and called its ADDRESS.
ALIGN	A means of copying Attribute characteristics from the first Fixture selected to other selected Fixtures, resulting in the Fixtures being aligned to each other.
ATTRIBUTE	One Channel or function of an Intelligent Fixture, such as "Colour Wheel".
ATTRIBUTE GROUPS	see IPCGBES.
AUTOLOAD	A playback which is automatically fired by a cue in a cue list. Enables a chase to be fired by a cue list.
BACKUPS	Copies of a show stored to an external storage device for safety.
BPM	Beats Per Minute. 60BPM is equivalent to one step per second.
BUSKING	Operating the console live (usually for live music) when you have insufficient programming and need to make up stunning effects as you go along using palettes etc.
CHASE	A sequence of one or more pre recorded steps which automatically run one after the other.
CHASE STEPS	Individual cues within a Chase. See above
COLOUR CHANGER	A mechanical Fixture for changing the colour of a light source, usually by scrolling through a roll of different coloured gels or by moving special filters into the light beam.
COLOUR MIX / CMY	A system of three filters that can each crossfade from white to a colour, or one colour to another. It is a feature of some Intelligent Fixtures, which enables thousands of different colours to be created.
CONNECTED CHASE	A Chase which has been brought under control of a chase Controller by pressing the CONNECT button.
CUE	A single stage look programmed onto a Playback button or fader. Also known as MEMORY, STATE, SCENE, LOOK.
CUE LIST	A sequence of cues programmed onto a Playback button or fader. Each cue can have its own delay and fade times and can also start other cues or playbacks. Also known as a CUE STACK or STACK.
CUE MODE	A playback format programmed into a Cue. There are Cue Modes 0 - 3.
DEVICE	See FIXTURE.
DIMMER	Device used to control the intensity of an individual light.

DMX	DMX512(1990) a specification for communication between control desks and Fixtures, Originally for Dimmers it has been adopted as a control protocol for most Intelligent Fixtures. It can carry 512 different Channels of data.
FADE	A continuous transition from one level to another.
FIXTURE	Any lighting instrument that is patched using a Personality. Generally refers to a moving light or colour changer, not an individual Dimmer channel. Also called Intelligent Fixture, Device, Instrument, Moving Light.
FLASH	Pushbutton which adds a playback into the existing output of the console. Historically called the ADD button. See also SWOP.
FLIP	A function for use with Moving Head Fixtures. They have two possible Pan and Tilt positions for each point on stage, and FLIP will alternate between them.
FOCUS	What Palettes are called on other Avolites consoles. See PALETTE. May also be used in connection with moving fixtures to focus (set the sharpness) of a gobo projection.
FUNCTION WHEEL	A wheel which does not directly control an Attribute channel on a fixture, rather it controls only part of an attribute and another function wheel may control other parts. For example a rotating gobo attribute may have one function wheel to control continuous or indexed mode, and another function wheel to control rotation speed or position, though the actual fixture only uses one DMX channel to control both these functions.
GENERIC	Term used to indicate a Dimmer channel. See also FIXTURE.
GROUP	A GROUP is a pre-programmed collection of Fixtures that can be selected with a single button press.
HANDLE	The preset fader and flash/swop buttons which are used to control an individual fixture or dimmer channel.
HTP	Highest Takes Precedence, a mechanism for determining the output level of a channel being controlled by more than one Playback. The Playback outputting the Highest value at any given time will determine the level of the channel. Also see LTP.
INCLUDE	A means of transferring the contents of a Cue or Chase Step into the Programmer.
INSTRUMENT	See FIXTURE.
INTELLIGENT FIXTURE	See FIXTURE.
IPCGBES	The Attribute Groups, used by the console to conveniently group together similar attributes. For example the P(osition) group includes Pan and Tilt attributes.

LCD	Refers to the console's on-board displays (stands for Liquid Crystal Display).
LED	Refers to the small red lights within the buttons on the console (stands for Light Emitting Diode).
LINKS	Connections between cues in a Cue List or Chase enabling them to run on from one to another automatically.
LOCATE	A feature of the console that makes it easy to find your selected Fixtures by putting them in Open White. Pressing Shift+Locate additionally sets the Pan and Tilt at 50%.
LTP	Latest Takes Precedence, a mechanism for passing control of a channel from one Playback to another on the basis that the latest Playback Fader to be moved has control, providing that Playback Fader has moved past the Trigger point. (See TRIGGER POINT). Also see HTP.
MACROS	Macros allow functions programmed into an Intelligent Fixture by the manufacturer to be executed by sending a DMX command sequence from the console. They can allow you to reset the Fixture for example. The DMX command sequences are defined within the Personality File.
MEMORY	The name for a Cue on other Avolites consoles.
MIDI	Stands for Musical Instrument Digital Interface. It is the established hardware and software specification enabling the exchange of data between digital musical instruments (such as keyboards) and other devices such as computers, sequencers and sound and lighting consoles.
ML MENU	Provides functions for control of Moving Lights (Moving Light Menu).
ON and OFF	Any channel stored in a playback can be On or Off. A channel which is ON is changed by the playback when it is fired. A channel which is OFF is stored in the playback for future re-use but has no effect when the playback is fired.
OVERLAP	Sets how the Diamond allocates new values to a group of fixtures. 100% means that all fixtures are updated simultaneously. 0% means that the fixtures will be updated one after the other.
PALETTE	A term used to describe a referenced pre-defined state for an Attribute that can be recalled whenever required during programming. Each Fixture may be set to a different value in the Palette, the entries can be named, and recalled with a single button press.
PARK	A Parked fixture is one which is patched to a handle but has no DMX address set. This happens to a fixture when its DMX address is taken by another fixture during a later patching session; the Repatch function is used to give it a new DMX address.

PERSONALITY	A description of what Attributes a particular Intelligent Fixture has and how the console will patch and use these. It also determines which Attribute Wheel will control which Attribute.
PLAYBACK	Area of the console that can replay recorded Cues or Chases using Playback Faders.
PRELOAD	A playback button which sets the LTP channels in a cue but not the HTP channels. Used to pre-position fixtures before firing a cue. Also a cue list function which allows one cue to preload the LTP channels in another cue.
PRESET FADERS	The faders across the top of the console which are used for controlling individual fixtures or dimmer channels.
PRESET FOCUS	What Palettes are called on other Avolites consoles. See PALETTE.
PROGRAMMER	The part of the console which contains Channel information which has been changed by the user, prior to recording.
SAFE	Desk mode in which all Playback functions are enabled, but all programming functions disabled.
SELECTED	A Fixture that is under manual control.
SEQUENCE	See CHASE.
SHAPE	A preprogrammed effect available which is applied to an Attribute. It can then be customised and stored in a Cue.
SHARED PALETTE	A Palette in which information is only stored for one Fixture, but is available to all Fixtures of that type.
SOFTKEY	Buttons marked A-J, with different functions which are shown on the LCD screen above.
STACK	See CUE LIST.
SWOP	Type of flash button which turns on the output being flashed and turns off all other output while the button is pressed. Sometimes called "Solo". Also used for selecting fixtures or playbacks when programming. See also FLASH.
TABLE	List of pre-defined levels for an attribute allowing settings to be recalled by name (for example the colours available from a colour wheel may be found in a table).
TIMECODE	An electronic timer signal which allows cue list playback to be synchronised to a soundtrack or other events. The console can read MIDI timecode or can take a timecode from the Windows sound player application "Winamp". An internal free-running timer is also provided.
TRACKING	A mode in which Moving Lights can move around an area all pointing at the same spot.
TRAINING	The process of recording points on a stage so that

	the console can work out the TRACKING for Moving Lights.
TRIGGER POINT	The level set in the User Settings which determines at which point a Playback Fader triggers the LTP Channels programmed onto it.
UNFOLD	A function that allows Chase Steps to be laid out onto Playback Faders for easy editing.
USER SETTINGS	User definable desk settings. Found in the Tools menu on the VDU.
VDU	A computer monitor plugged into the VDU socket on the Diamond giving further information about the operation of the console.
VIRTUAL DIMMER	Used with LED RGB (red-green-blue) colour mixing fixtures, these add an intensity function to the fixture which masters the RGB controls on the fixture when it does not actually have an intensity control channel.
WIPEALL	A process which clears all the previous programming out of the desk, but does not touch the System Software.
WHEEL	Wheels are used on the Diamond to set Fixture Attributes and to control chases and cue lists (see FUNCTION WHEEL).



Copyright Avolites Limited 2010

## New for Titan v3.0

This section lists the major changes in Titan v3.0 software from the previous Diamond 4 version (v2.4). Full release notes including bug fixes can be found in the Diamond 4 download section of the Avolites Website (see front of manual for web addresses).

### Upgrade procedure

Upgrading from: 2.4:

In order to upgrade your console from any previous version of software to D4 Titan you must contact Avolites. To request a copy of the beta software, please contact [software@avolites.com](mailto:software@avolites.com).

### New Features

*Loading Show From Another Console:* It is now possible to load in a show from another Titan console. Load the Expert Titan or Tiger Touch Titan show in and use the [PASTE] button to assign handles to your items. On the Pearl Expert open the [Disk] menu and press softkey E to access the paste menu. Then press softkey A to show unassigned items.

*Cue List Shapes:* Shape size and speed can now be controlled in cue lists. To set go into playback options

*Release:* The release feature has now been implemented so playbacks will fade back to the previous values when they are killed. To enable go to 'Playback Options' and choose 'Release Settings'

*Playback Priority:* Playbacks now have priorities so that a lower priority playback will not take control of attributes from a higher priority playback. To set go to 'Playback Options' and choose playback priority

*Attribute Times on Wheels:* It is now possible to set the attribute times using the wheels and attribute banks of the fixture. To do this go into the set times menu and press attribute times. Now the times for each attribute of the fixture selection will appear on the wheels and allow you to set by moving them. Switch between setting fade and delay by pressing the [FADE] button. Pressing the 'Fan' button will fan the times across the fixtures.

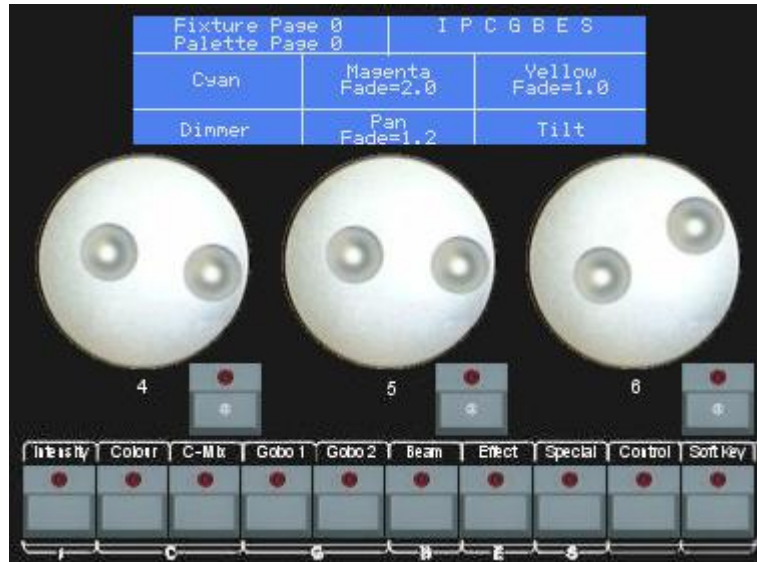

**Kill Time:** The kill time button now works. When pressed all timings on the desk would be 0 and everything will happen instantly. To disable press the kill time button again

**Filter By Name In Patch Menu:** It is now possible to filter the patch list by typing in your desired fixture. Go to Patch->Fixtures and first type the manufacturer name using the keyboard, then after selecting type the fixture name



**Playback Locks:** It is now possible to lock a playback so that it will appear on every page in the same position. Go to Utilities->Lock Playback and select the playbacks you wish to lock. A padlock will appear on the playback to indicate it is locked

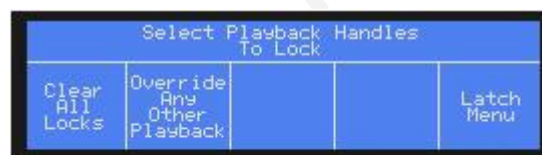

**Playback Viewer:** The playback viewer now has all editable fields except the autoload field. To use press the view button above any playback on the playback handles, and enter values using your keyboard.

#	Legend	Delay	Fade	Link	Cue Overlap	Fixture Overlap	Timecode	Curve	PreLoad	AutoLoad	Notes
1.0	Cue 1	0.0	2.0	Off	100%	100%	Not Enabled	<None>	No		Here are some notes
2.0	Cue 2	0.0	2.0	Off	100%	100%	Not Enabled	<None>	No		
3.0	Cue 3	0.0	2.0	Off	100%	100%	Not Enabled	<None>	No		
4.0	Cue 4	0.0	2.0	Off	100%	100%	Not Enabled	<None>	No		
5.0	Cue 5	0.0	2.0	Off	100%	100%	Not Enabled	<None>	No		
6.0	Cue 6	0.0	2.0	Off	100%	100%	Not Enabled	<None>	No		

*Virtual Panel Parts:* The virtual panel has been split into sections that are accessible individually from the main panel. This allows ease of programming without having to scroll back and forth around the panel. There are 7 sections (Softkeys, Attribute Control, Playback Controllers, Playbacks, Presets, Function Keys and System Control) found under the toolbar Tools->Virtual Panel



*Quick Palettes:* Quick palettes have been implemented. To use turn on the quick palettes user setting and press a palette button when no fixtures are selected. Setup -> User settings -> Panel -> Enable Global Quick Palettes

*Preload Times:* It is now possible to input a preload fade time in the same way as palette fade times. To do this type in a time when you are in the main menu. This will now display the preload time menu with the time entered. Now press the preload button of a cue and it will move to the position over the fade time

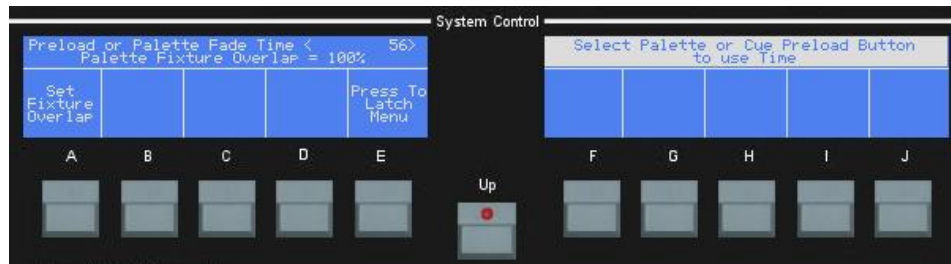

**Link Copy:** It is now possible to link copy playbacks. A link copy is a copied playback that will always be identical to its master even after subsequent changes are made. To do this hold down the flash button under the playback when in the copy menu and select the destination handle you want to link copy to

**Double @ Press:** Pressing the @ button twice on any percentage attribute will set that value to full. If you double press the @ button for a range value it will put it into the programmer but leave it at its current value.

**Recording Cue List From Existing Cues:** It is now possible to record a cue list from a group of existing cues. To do this go into the 'Record Cue List' menu and press 'Record List From Existing Cues'. Then select the cues in the order you want them to record in the list. Finally press 'Record Cue List' and select a handle.

**Shape Phase Offset:** There is now a phase offset property for shapes, giving the ability to run shapes at different phases to each other. To access this go to the second page of shape properties

**Palette Times:** It is now possible to assign fade and fixture overlap times to a palette and have these times stored in the palette. To do this press 'Set Times' then a palette button.

**Copy, Delete or Move Cues Between Playbacks:** We now have the ability to copy, move or delete multiple cues of a playback into other playbacks. To use go into the copy, move or delete menu and press softkey F and follow through the menus

**Cue List Tracking:** The ability to turn off tracking in cue lists has been implemented. To do so go into Playback Options->Cue List Options and set Forward Tracking

**Odd/Even Fixture Selection:** It is now possible to filter your fixture selection by odd/even fixtures. To do this go into the fixture select menu and press softkey F or G

**Out of Range Timecode Playbacks:** A user setting has been added to tell the software not to load timecode playbacks that have their last cue time before the current time.

**Quick Park:** Implemented ability to park multiple fixture at once. To do this go to the edit fixtures menu within the patch menu and select park fixture. Then select the range of fixtures you want to park

**Clear Fixture:** You can now clear all the attributes of a fixture from the programmer by holding [Shift] and pressing the swop button of that fixture. This also works for groups.

**Selective Clear:** It is now possible to only clear selected attributes or groups of attributes. Hold down the clear button to select the mask of groups to clear

**Multiple Autosaves:** The desk now creates more than 1 autosave so it's

possible to go back to several points of the show. To set the amount go into the user settings

*Update Personality File:* There is a new 'Update Personality File' option within the Patch->Edit Fixtures menu. This will update the personalities of fixtures already patched and for each subsequent patch. To use press 'Update Personality File' and browse for the personality file you wish to use. The personality will revert back to patching to default when a wipeall is done or the show is reloaded. However the fixtures saved with the new personality will keep the new one

*Save Show in Old Format:* There is an option in the save show menu to save your show into the old format. This will mean it can be loaded into a pre-Titan version of software

*Desk Backup:* All Titan consoles are show compatible. You can now use any Titan consoles, Tiger Touch or Pearl Expert to serve as a backup console for your D4.

## Improvements

Fixture Selection:

The fixture selection menu has been improved. It is now possible to select odd and even fixtures. Also a display of the current command is shown to the user

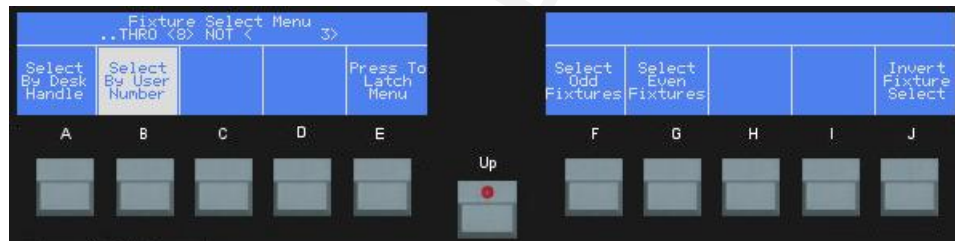

*Shape Release:* Shapes will now release back to any previously running shapes when killed. So if you fire a circle on cue 1 then a square on cue 2, when cue 2 is killed the shape will fade back into a circle if cue 1 is still running.

*Mode 2 Shape Control:* The fade of shapes will now be controlled by the fader on mode 1 and 2 cues. So if a circle was fired on cue 1 then a square on cue 2 the fixtures would gradually fade into a square the higher the fader went. This is also controllable from beyond the most recent cue fired so if all your faders are at 50% moving the earliest one will have the correct affect on the output. This affects size and speed on faders which is now applicable for all modes. To use as previously expected set your cue to mode 0 instead of mode 2.

*Renumber Cues:* It is now possible to renumber a range of cues in a list or chase. To do so enter unfold and press 'Renumber Cues' Then type a starting cue number (or leave blank to use first cue as starting point) and press THRU. Then type an end cue number (or leave blank to use last cue as end point) and press enter. All of the cues between these two points will now be renumbered and evenly spread.





*Size + Speed on Cue Lists:* It is now possible to control size + speed of shapes on a cue list fader. To do so go into 'Playback Options' and enable the relevant settings.



*Wheel Acceleration:* The wheel acceleration range has been extended to go beyond the current maximum speed

*Patching Speed:* The speed of patching has now been dramatically improved

*Copy Group Fixture:* Copying a fixture now adds the copy to any existing groups that shared the source fixture.

*Align:* Align now work across different fixture types

*IPCGBES Indicator:* There is now a display of the current attributes that are in the programmer. This allows the user to easily see the attributes they are using and set the mask accordingly. Each of the letters will highlight when that attribute group is in the programmer and when you record a playback a second display will appear below the current one showing you which attribute groups you are recording if using record by mask or channel



**Timecode Menu:** The timecode menu now has been altered for ease of use. You now only need to activate the playback instead of activate and enable. The Internal clock controls have been changed so now play/pause is on the same button and set start time is in the main timecode menu. New symbols have also been added to the play/pause buttons

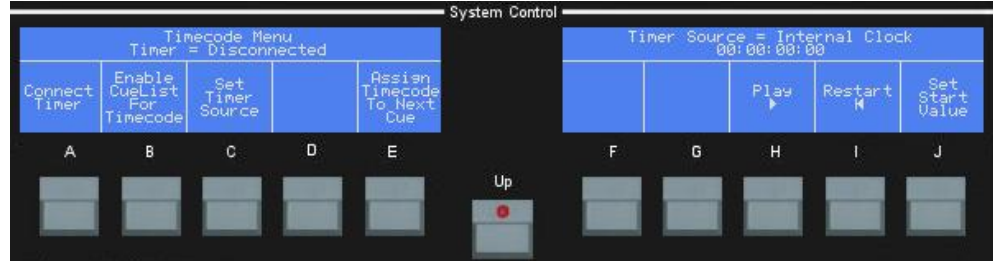

**Shape Engine:** The running of the shape engine has now improved so it is more compatible with the duel core processor

**Selecting Range Of Items For Delete:** It is now possible to select a range of items to delete at once. To do this go into the delete menu, hold the first and last items of the range you wish to delete and press Softkey A

**Copy Selection:** It is now possible to copy multiple items at once by multiple selection. To do this hold down the first item when in the copy menu and select the last item to highlight a range. Then when selecting the destination you must make sure your selection will fit into the space specified

**Heldover Playback Indicator:** There is now an indicator for playbacks that are heldover. A downwards arrow indicates it is stored on a page below and an upwards arrow indicates it is stored on a page above the current page. A heldover playback is a playback that is fired from a different page than the current one

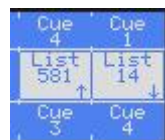

**Shared Palette Indicator:** There is now a '\$' symbol displayed on palettes to indicate they are shared palettes. This is displayed next to the legend

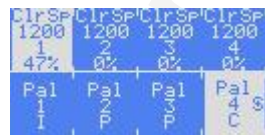

**Cue Mode Indicator:** There is now a cue mode indicator when a cue is stored on the playback handles. This will display 0,1,2,3 depending on which type of cue it is and is displayed next to the legend

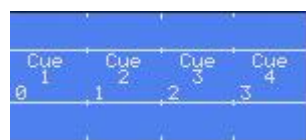

**Chase Indicator:** There is now a display of the speed a chase currently has if it is recorded on a playback handle. Also the direction of the



chase is indicated. F=Forwards, R=Reversed, B=Bounce and X=Random



*Flash In Fixture Mode:* The flash buttons now flash fixtures in fixture mode as long as there is nothing on the palette handle

*Shape Fixture Order:* The set shape fixture order menu has been improved. It is now possible to set more than 1 fixture to the same order.

*User Settings:* The user settings can now be accessed and changed through the panel. Go to Setup->User Settings

*Preload Next Cue:* Preload now works in cue lists. If you turn on the option to preload the next cue from Playback Options->Preload(softkey C) it will move to its assigned position if the intensity is zero.

*Stop On Last Step:* There is now an indicator on the playback controller when a chase is 'stopped on last step'

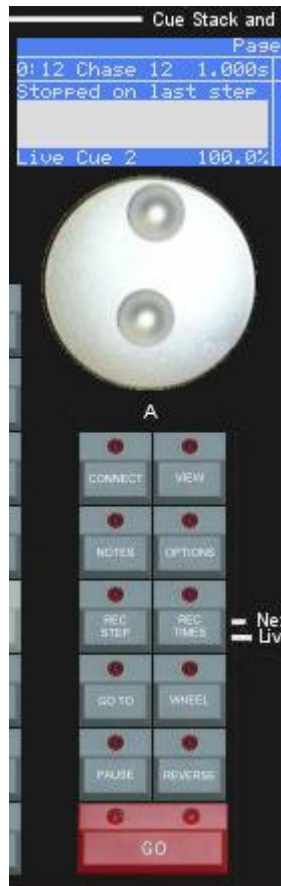

*Latch In Fixture Menu:* There is now a latch option in the fixture menu

*LCDs On Shutdown:* When the D4 software is closed the LCDs will now clear and display a shutdown message. This makes it clear the desk is not in use

*Number Playbacks Incrementally:* There is a new option to number playbacks incrementally (1,2,3,4) rather than by handle. This is found

in the user settings

*Selecting Page:* When selecting page using 'Go page' or 'select fixture/palette page' it will now display all of the pages in use on the softkeys. You can also scroll through them using the back and next buttons. This also works in the set page legend menu

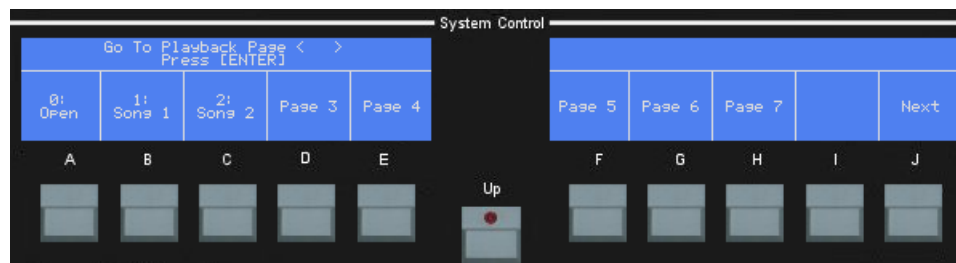

*User Settings:* The user settings menu has had a radical new design to make it aesthetically pleasing

*DMX Outputs:* You can now 'remove all nodes' from the DMX outputs tree

*Latch Option For Record Group:* There is now a latch option in the record group menu on softkey 'E'

*Copy Failing:* The Copy and Move functions now display error messages when they fail. eg. trying to copy on top of an existing item.

*Load Show:* The software will now attempt to load the xml show file if the binary fails for any reason

*Error Messages:* The error messages are now indexed when they appear in the command line. This allows Avolites to diagnose faults easier

## Changes

*Tracking Backup:* Backup has been restricted to hardware only to improve system reliability. To use backup plug in the USB cables to both your consoles and transfer the show manually to the backup console. If you are using a different desk type, paste the items onto the handles, save the show and transfer the show to both desks manually.

*Link:* Link has been change to 'After Previous' instead of 'On' and 'With Previous' has been added

*Clear Timed Palettes:* Timed palettes from the programmer will now continue to run after the clear button is pressed

*Visualiser:* Visualiser has been removed from the toolbar as it did not work correctly

*Timecode Viewer:* Timecode viewer has been removed due to stability issues

*Show Library:* Show Library has been removed from opening on the panel due to stability issues

*Stage View:* The Dmx outputs window is not allowed to open when stage view is open due to stability issues. Stage view has also been removed from being allowed to open through the panel

*Page Display:* The Fixture/Palette page display has been moved so it is visible while in other menus. It is now found above the attribute

controllers

*Renumber Cues:* The renumber cues option has been moved into unfold. Go to Unfold->Renumber Cues To Integers

*Copy Legend:* The 'Press to copy legend' button has been renamed to 'Press to include legend' to avoid confusion from a copy function that only did legend without the item. This is found in the copy menu

*Timecode Fader:* When a playback is activated via timecode it's fader no longer controls HTP levels. They are always set to full.

*Edit Fixtures:* The Swap pan/tilt and invert channels functions have been moved into an edit fixtures menu within patch. Go to Patch->Edit Fixtures(Softkey H)

*Delay Autosave:* The delay autosave by 10 mins button has been moved into setup to softkey J

*Dimmer Units Menu:* The dimmer units menu has moved from the '.' key to shift+dim@

*Set DMX line:* The menu option "Set DMX line" in the patch menu has been re-named to "Change DMX Line Mapping"

*Create Patch List:* Create Patch List has been moved to the Patch Menu

*More Options Renamed:* In the cue list set times menu, softkey J has been renamed from 'More Options' to 'Cuelist Options' as more options suggests that it leads to more options for the current cue

*Palette Attribute Groups:* The display to lots of attribute groups in a palette has changed from '+' to '...'

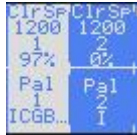

*Shortcut Displays:* Shortcuts have changed their display information on the screens slightly to incorporate 4 lines of text

*Shortcut Menu:* Shortcut menu has moved to the utilities menu and renamed 'Record Shortcut'

*Masters:* The ordering of the masters has now changed to be more consistent with the Pearl. The order is now: Grand Master, Swap, Flash, Preset, Playback

*Change Bank To Page:* The LCD display of fixture bank and palette bank has changed to fixture page and palette page.

*IP Address Menu:* The setting IP address menu has changed to make it more user friendly

*Invert Fixture Selection:* The invert fixture selection has been added to the fixture menu on softkey H

## Bugs fixed

*Fader Firing:* On very rare occasions a fader would not fire when raised. This is now fixed

*Blank Fixture In Patch Menu:* If a personality had an error and could not load the desk would create a blank fixture type in the patch menu.

This is now fixed

*Shape Parameters Display 0:* If multiple shapes were created, it was possible for the display's to show all the parameters at 0 even though values were stored in the shape. This is now fixed

*Intensity Flashes Full:* It was possible for a playback to flash up to full when moving the fader. This is now fixed

*Palette Display:* Palettes would not update the LCD's correctly when applied. This is now fixed

*Timecode Source Crash:* The software could crash when changing the timecode source. This is now fixed

*Dmx View:* It was possible for the dmx view to stop updating correctly. This is now fixed

*Grand Master Controlling Wheel Values:* Grand Master would not control values that were set using the wheels. This is now fixed

*Grand Master Affecting Recorded Values:* The grand master would affect the values recorded if applied to values in the programmer. This is now fixed

*Glitchy Masters:* The output could become glitchy if the masters were moved very fast. This is now fixed

*Shapes Reload From 0:* When a shape was refired during it's fade out time it would snap back to 0 and fade from there. This is now fixed

*Shapes Fade Out When Refired:* If a cue was constantly killed and re-fired it was possible for the shape to stop and not be fired again. This is now fixed

*Shape Fade Out Times:* If an attribute delay was set it could interfere with shape fade out times. This is now fixed

*Shape Phase Load:* Shape phase would not load in with the xml file load. This is now fixed

*Saving Show in Non-existent Directory:* If the temporary directory was deleted after loading a show then that show could no longer be saved. This is now fixed

*Chases Not Running:* Chases would not fire if reversed with 0% cross fade. This is now fixed

*Fixtures With 1 Range Value:* Fixtures that were set to only have a range value of 1 could not be set. This is now fixed

*Threadlock with Editor:* The software could lock up when setting editor values at the same time as running chases. This is now fixed

*Preloading Chases:* Chases would not preload when the preload button was pressed. This is now fixed

*1 Too Many Fixtures Parked:* The desk parks one too many fixtures on re-patch this is now fixed

*Mode 2 Return Point:* The state for a mode 2 cue to return to when killed has been improved. It now works correctly when fired during a fade out

*LTP Return Points:* If a cue with fixture overlap is fired with a long fade time and a separate cue is fired and killed again quickly, the LTP channels will not be taken over by the new cue. This is now fixed

*Return To Playback State With Palettes:* Return to playback state would not work when a palette was fired. This is now fixed

*Replace Playback:* Replacing a playback would not remove the references to the old fixtures meaning that fixture order would get confused. This is now fixed

*HTP Fades Remain:* HTP fades remain on the stack causing problems where intensity would glitch back on. This is now fixed

*Fixture Overlap With Os:* Setting fixture overlap on a cue with a 0s fade time would have no effect for a mode 1 or 2 cue. This is now fixed

*Timecode With Link Cues:* Linked cues would not fire in a timecode list. This is now fixed

*Fixture Order:* Fixtures that have no channels tagged are no longer recorded into fixture order in channel mode

*Deleting Shapes Fixtures:* The software could lock up when deleting fixtures with shapes running on them. This is now fixed

*Autoloads Don't Fire:* Autoloads don't fire the cues they're supposed to, only setting it as the next cue waiting for you to push go. This is now fixed

*Autoloads Drop Out:* Autoload intensities drop out when using timecode cue lists. This is now fixed

*Programmer Shapes:* Adding a shape to a fixture in the programmer stops any other shapes running on that fixture. This is now fixed

*Timecode Cue Lists Get Stuck On:* It was possible for a list that's running on timecode to get stuck on. This is now fixed

*DMX View:* Opening the dmx view would create an internal timer that never stopped and caused unnecessary processing. This is now fixed

*User Settings File:* Changing user settings file to read only caused the software to crash. This is now fixed

*Firing Palettes:* The software became extremely slow when firing palettes quickly. This is now fixed

*Patch Crash:* The desk could crash if you try to patch a fixture before it's finished loading. This is now fixed

*Mode 3 Intensities:* Intensities could get stuck on when a mode 3 cue is fired taking over cues that are already fired. This is now fixed

*Manual Control Cue Lists:* Cue lists under manual control would fire twice if you pressed GO. This is now fixed

*Grand Master:* The grand master would not work properly when intensity was wound in with the wheel. This is now fixed

*Loading Freeze:* The software could freeze while loading a show. This is now fixed

*Cue List Fire Point:* If you have a cue list to set a position and have it fire from a locate state, when the list loops back around to the first cue everything will re-fire from that original locate state. This is now fixed

*Shutdown Freeze:* The software could freeze during the shutdown process. This is now fixed

*Exchange Crash:* Exchanging all fixtures patched crashes the desk. This is now fixed

*Information Lost On Exchange:* Exchanging a fixture more than once could cause palette links to break. This is now fixed

*Off Modifies Values:* Using off on certain fixtures would invert the range each time the function was used. This is now fixed

*Performance of Dmx Calculation:* Performance analysis suggests that dmx calculation is slow when controlling large groups of fixtures in the programmer. This was causing a slight lag in dmx response from the users actions at the desk. This is now fixed

*Deleting Multiple Dimmers:* When deleting multiple dimmers from 1 handle the dmx address assignment may not be removed correctly causing dmx addresses that the user can no longer patch to. This is now fixed

*Fixture Exchange Errors:* Sometimes when doing a fixture exchange lots of error messages will be displayed that the xml file has not been saved correctly. This is now fixed

*Repatching a Fixture to Line 0:* If a fixture was repatched to line 0 the software would crash. This is now fixed

*Memory Management:* A problem existed with the fade engine where it would keep allocating memory if a chase was running with values being set in the programmer, causing a large slowdown in the software. This is now fixed

*Merging Shared Palettes into Normal:* When shared palette values are recorded over normal values the palette would still apply the normal ones when fired. This is now fixed so that the palette will use the latest recorded values to fire

*Shape Slow Down:* Shapes would begin to run slower if the desk was doing a lot of processing. This is now fixed so that the speed remains constant

*Shape Synchronisation:* If a cue containing more than 1 shape of the same speed was fired then left for a while the shapes would lose synchronization with each other. This is now fixed

*Grand Master Snaps Intensity:* Moving the grand master could snap the intensity to full on certain fixtures. This is now fixed

*Can't Load Xml if Binary File Has Same Name:* If the user tried to load an xml file and a binary file with the same name existed in that folder then the software would always load the binary. This is now fixed

*Mode 1 Intensity Delay:* When delay was set for intensity on a mode 1 cue, the delay would not run in the time specified. This is now fixed

*Shared Palettes and Fixture Exchange:* Shared palettes would no longer fire in the programmer after a fixture exchange until updated. This is now fixed

*Lights Get Stuck On:* Intensity would get stuck at the value it was currently set to if changing a mode 1 cue to mode 0 while it was currently live. This is now fixed

*Cue List Time:* Cue lists would ignore fade times if the times set were longer than the time it took to loop back around to the start of the list again. This is now fixed

*Preset Master Could Lose Control Of Intensity:* When using a preset master with dimmers, by setting the dimmers to full then bringing the master down, when clear was pressed both the dimmer faders and the

master would lose control of intensity. This is now fixed

*Autoload Takes Control Of Fader:* When autoloading a cue from the same handle as the cue list but from a different page (eg. handle 9 on page 1 and handle 9 on page 2) when the autoload was fired the list would loose control of the fader. This is now fixed

*GoTo On Chases:* It is now possible to use GoTo by pressing enter and 'cut to live' while a chase is running

*Can't Access Page Change While In Unfold:* It is now possible to change fixture and palette pages while in unfold

*Show Library Out Times:* The display for delay out time in the show library now shows 'none' if none is selected

*Flash Buttons:* The flash buttons now work when in the 'set times' menu

*Notes Button:* The notes button now works on the playback controller. Press Notes when you have a playback connected and you will be in the notes menu

*Playback Autoloading Itself:* When an autoload was set and fired, if the autoloading cue was then deleted the list would think it had to autoload itself. This is now fixed

*Select If In Unfold:* Select if now works when in the unfold menu

*Playback Viewer:* The playback viewer now runs more smoothly. Try changing the speed of a chase whilst it is running and it will no longer struggle to keep up with the changes

*Changing Pages In Hi-Light:* Can now change playback, fixture and palette pages after pressing shift+hi-light

*Show Library Opens When You Don't Want It To:* After opening the show library from the view menu, if you immediately close it then press up, the show library would reopen. Now it doesn't

*Chase Would Not fire:* If you had a chase connected to the playback controller but on a different page to your current one, pressing 'go' would not make it fire. Now it does

*Chase Run Mode:* If a chase was running in random mode and the reverse button was pressed it would not go to reverse mode. Now it does

*Stage View:* You can now only open one copy of the stage view. It will now front when called for instead of opening multiple copies

*Intensity:* You can now only open one copy of the intensity view. It will now front when called for instead of opening multiple copies

*Unfolding A Heldover Playback:* It is now possible to unfold a playback that is heldover

*Playback Viewer Update:* The playback viewer would not update when cues were inserted while in unfold. This is now fixed

*Set Times And Playback Options:* It is now possible to use set times and playback options on a playback that is heldover

*Connect A Heldover Playback:* It is now possible to connect a playback that is heldover

*Copy Heldover Playback:* It is now possible to copy a heldover playback

*Move within range:* It is now possible to select a range of items and move to a point within the range (eg. select fixtures on handles 1-5 and move the group to handle 3)

*Select If Heldover Playbacks:* It is now possible to use select if on a playback that is heldover

*Select If On Palettes:* When a palette was applied to a cue which was fired, select if would not select the fixtures. This is now fixed

*Ghost Item On Moved Handle:* Sometimes when moving an item from one handle to another you could no longer create an item over the handle it used to be on. The desk would think it already had something there and display an error. This is now fixed

*Recall Stage and Define Stage Opened Same Menu:* When pressing 'recall stage' the desk would open up a menu called 'define stage'. This is now fixed

*'Flip' nothing happens:* The LCD's were not updating when 'flip' was pressed which made it appear nothing was happening. This is now fixed

*Attribute Overlap Start Times:* When changing intensity attribute overlap start time to 50, every single other attribute start time would be set to 50 aswell. This is now fixed

*Default Directory Is Wrong:* In factory settings pressing set to defaults would set the directory to the wrong path. This is now fixed

*GoTo On Unloaded Cue List:* It is now possible to use GoTo on a cue list that has not been fired or loaded

*Sorting Of Playbacks In Show Library:* Playbacks are now sorted alphabetically in the show library

*Reversed Chase:* When a chase is set to reverse mode, if you kill and re-fire the chase it would go back to forwards. This is now fixed

*Deleted Fixture In Programmer:* If you patched a fixture and changed some attributes in the programmer, then deleted the fixture, the displays would still show the attributes and the clear button would still flash. This is now fixed

*Shape Menu Jump:* If you have more than 10 shapes running and go into edit shape menu. As soon as you select a shape on any page it will jump back to page 1

*Playback Controllers:* Playback controllers would not work in safe mode. Now they do

*Patching Address:* When trying to patch, if softkey B (DMX=1) was pressed and a value entered, then exit pressed. The LCD's would display DMX=1 but when patched it would take the new value

*Swapping From Programmer:* If there are values in the programmer and the swop of a playback is pressed, after the swop is released the values in the programmer are not restored. This is now fixed

*@ Menu Input:* If you select a fixture with an attribute with a range but no table and press the @ button for that attribute. After pressing select from table you can no longer enter values with the keypad. This is now fixed

*Playback Options:* If you go to the playback options of a cue and press up it would ask you to select another playback instead of coming out of that menu. This is now fixed



*Chase Speed Updates:* If the speed of a chase is changed whilst in the set times menu it is now updated on screen on the softkey showing the current time

*Chase Playback Options Now Work When Expected:* If the direction of a chase was changed during running it would not update and carry on in it's original direction. This is now fixed

*LCD's In Unfold:* The playback LCD's now refresh when using 'renumber cues' in unfold. So they will now display the correct new legends

*Off In Unfold:* Off now works when in unfold mode

*Palette User Numbers:* When copying a palette it's user number would disappear and change to ---. This is now fixed as it will change to the next available user number

*Deleting User Profiles:* It is now possible to delete user profiles in the File->Change User menu

*Changing Page While In Set Legend:* When you changed a page whilst trying to set a legend it would sometimes set the legend to the wrong playback. This is now fixed.

*Playback Options In Unfold:* The main playback options menu for a cue list is now equivalent to the same menu in unfold

*Cue Copy:* The console could crash when copying a cue in unfold. This is now fixed

*Shape Speed Display:* When setting the speed of a shape the speed in secs and BPM did not match. This is now fixed

*Unfolded Shape:* A shape fired from an unfolded chase cannot be stopped. This is now fixed

*Patching Dimmers:* It is now no longer possible to patch 2 dimmers with the same address on top of each other

*Cue Legends:* Cue legends now update when changed whilst the playback is running

*Autoload On Same Handle:* It is now possible to autoload playbacks on the same handle across different pages without the cue list being killed

*Reverse Light:* When you reverse a chase the reverse light on the playback controller now works

*Mode 2 HTP Levels:* When a mode 2 cue was recorded with a shape the HTP values did not correspond to the fader. This is now fixed

*Palette Times:* When you set a fade time for a palette, then set a fixture overlap time the palette time is overridden. This is now fixed

*Stage View:* Attributes are now highlighted correctly in the stage view when they are 'switched on'

*Switch On All Cues:* The 'All Cues' function now works in the switch on menu

*Timecode Timer:* When you disconnect the timecode timer it will now stop firing timecode playbacks

*Timecode Activation:* When you deactivate a playback from timecode it will now stop firing the timecode cues

*Cue Lists In Add/Swop:* When a cue list was killed in add/swop mode using the shift key it would no longer fire at the fader level until the

fade was brought back to zero and fired again. This is now fixed

*Zero Step Chase:* Firing a chase with zero steps would get stuck on the screen. This is now fixed

*Create Patch List:* When in the create patch list menu pressing 1 and 2 on the keypad would select and save the patch. It should only work with the softkeys. This is now fixed

*Entering Show Name:* When saving a show if you press 'Use current show' twice you can no longer enter a name using the keyboard

*Fading Out Cues:* If an attribute time was set on a mode 1 cue that had a fade out time, the cue would take a long time to fade out. This is now fixed.

*Move Heldover Playback:* It is now possible to move a playback that is heldover from another page from your current page

*Lock Control Range Bug:* There was a problem when 'Lock Control Range' was enabled that the wheels would go into the wrong menu. This is now fixed

*Dim@ Menu:* When in fixture menu pressing dimmer wheel @ button opens a different menu to normal, this now opens the correct menu

*Copy and Move LED's:* The copy and move LED's no longer remain lit after the menu is exited

*AvoUSB compatibility:* AvoUSB is now compatible with version 9.2 of windriver, this will fix panels not being detected

*Edit Shape Menu:* You will no longer have multiple shapes that aren't running appear in the edit shape menu

*Editing Shape Fixtures:* It is now possible to select\de-select individual fixtures when in the edit shape menu

*Shapes stuck in mode 2:* It was possible to have a shape stuck in it's fader size+speed from mode 2 after it had changed mode. This resulted in the shape running improperly or not at all. This is now fixed

*Shape Speed:* It is now possible to alter the speed of individual fixtures within a shape

*Shapes stuck on:* It was possible to have a shape from a playback running with the playback fader at 0. This is now fixed

*Playback Display:* It was possible to lose the display on playbacks when deleting a separate playback. This is now fixed

*Show name display:* Show name on LCD did not change when the 'File' -> 'Load Show' menu item is used. This is now fixed

*Load show crash:* It was possible to crash the d4 when loading an xml file. This is now fixed

*Change page crash:* It was possible to crash the d4 when the page legend exceeded 40 characters. This is now fixed

*Preset master does not control programmer:* The preset master did not control the programmer. Now it does

*Playback master interferes with manual cue list control:* The playback master interfered with manual cue list control by changing the fire point of the next cue. This is now fixed

*Crash When Editing Shapes:* It was possible to crash the console when

going into the edit shape menu when no shapes were running, while previously there were. This is now fixed

*Crash While Re-patching a Fixture:* If a fixture personality had an error it would crash the desk when trying to repatch. This is now fixed

*Mode 2 Cues Wouldn't Work With a 0 Fade Time:* If a mode 2 cue had a fade in time of 0 seconds set, it would not fire correctly. This is now fixed

*Load DMX Patch:* Load DMX patch now works with .d4z files instead of just .xml files

*Cues Re-Fire When Trying To Record:* Cues now no longer re-fire when updated during live playback

*Playbacks Update When Recorded Live:* Playbacks now get updated with the changed information when they are updated when live.

*Inputting Numbers In Menus:* Some menus would not accept numerical values. This is now fixed

*Swops on Programmer Fixtures:* When swopping fixtures in the programmer, all intensities would go out. This is now fixed

*Recording Palettes in Record By Channel:* Palettes would not record into cues correctly when using record by channel. This is now fixed

*Mode 2 Cues Returning Attribute Functions:* If a mode 2 cue was fired that contained an attribute function with no range, it would not return to the previous value when it was killed. This is now fixed

*Using @ Button to Edit Shapes:* If editing a shape fired from a playback the @ button would not work. This is now fixed

*Fader Losing Control of Playback:* If a playback was fired by the fader and then killed on the swop button. When fired again through the playback controller the fader would not control the level. This is now fixed

*Setting Chase Speed to 0 Pauses Chase:* When a chase speed was set to 0 it would pause the chase and not run again when the speed was increased. This is now fixed

*Record Mode Saved Upon Restart:* The record mode is now saved so that it selects the same option when the software is restarted

*Shared Palette Sometimes Wouldn't Record:* Shared palettes were not recording unless the fixtures were selected. They now store the programmer information

*Shapes Don't Fade Out:* Shapes recorded into a mode 1 cue were not fading out with the fade out time. This is now fixed

*Shift+Record Cue:* Pressing shift+record cue was not working. Now it is

*Set Legend Losing Characters:* Setting the legend of a playback with an odd number of letters would not display the middle character. This is now fixed

*Including Shapes:* If a shape was included into the programmer more than 16 times it would no longer be removed when clear was pressed. This is now fixed

*Dimmers Stuck in Programmer:* After firing cues that have dimmers recorded while in unfold, when exiting unfold the dimmers would be stuck on. This is now fixed

*Show Library Editing Wrong Cells:* When editing values in the show library, it would sometimes edit a different cell to the one selected. This is now fixed

*Playback Controller Notes Display:* The notes display on the playback controller now displays 60 characters

*Lines on LCD's:* When starting the software the LCD's would not refresh correctly and lines would appear across the desk. This is now fixed

*Record Palette LCD:* The record palette LCD now lights up when in the menu

*Fan is Too Quick:* When using the fan function it would move the fixtures at double the speed the wheel was moving. This is now fixed

*Exiting Fixture Select Menu:* If locate was pressed when in the fixture select menu, it would exit the menu. This is now fixed

*Highlight and Lowlight Values:* Highlight and lowlight values are now loaded in from the personality

*Playbacks on Presets:* Playback running on presets are now highlighted when they are active

*Using NOT in Fixture Selection:* When typing in a command in the fixture selection menu such as 1 THRO 5 NOT 4 all 5 would get selected. This is now fixed

*As In Fade Time:* Pressing as in on a cue's fade out time menu would not work. This is now fixed

*Using All Patch Slots Locks Desk:* If all of the available channels on the desk are used up, the software will freeze when trying to patch anything else. This is now fixed

*Copying Empty Playbacks:* When copying a playback with no cues it would take control of the handle so that nothing else could be recorded on top, but not copy the playback. Now it outputs an error and does not take control of the handle

*Heldover Playbacks:* You now have the ability to include, off, set legend and view heldover playbacks

*Fixture Legend:* Fixture legends were getting truncated to 10 characters when the show was saved and re-loaded. This is now fixed

*Fixture Control Names:* The names of fixture controls and functions were wrong when looking at them in the @ menu. This is now fixed

*LTP on Flash:* Pressing flash button of a playback would not take control of the attributes if pressed after the playback was fired. This is now fixed

*Fixture Crash:* The desk would crash if a fixture with a wrong personality was patched. This is now fixed

*Can't Replace Cue Created With Palettes:* If a cue was recorded that contained palette information, it was not possible to replace the palette values with hard values by re-recording over the top of it

*Shapes Don't Resume After Swop:* Shapes were not resuming after being swopped out. This is now fixed

*Fixture Order In Quick Palettes:* Quick palettes were not firing in the fixture order they were saved in. This is now fixed

*Switching Off Live Intensity:* Switching off a cue that had live intensity

would crash the desk. This is now fixed

*Fixture Selection Order:* When using the fixture menu for selecting fixtures it would not select them in a linear order when using through. This is now fixed

*Busking Palette Fixture Overlap:* Fixture Overlap would not work when busking palettes. This is now fixed

*Can't Delete Shortcuts:* It was not possible to delete a shortcut. Now it is

*Programmer Selection Using Palettes:* When fixtures are selected and then a palette applied they should go into the programmer selection so that the next time a fixture is selected it de-selects the rest.

*Shape Control For Mode 1:* Shape size and speed on fader did not work for mode 1 cues. Now it does

*Saving Xml Would Sometimes Freeze The Desk:* Doing an xml save would very occasionally freeze the desk. This is now fixed

*Fade Times Don't Complete:* The attribute fade times would not complete correctly if they were greater than the global fade time. This is now fixed

*Chase Menu Exit:* The exit key would not work to get out of the chase menu. Now it does

*Shapes Fading Speed:* The speed fade going from one shape to another was not working correctly. This has been improved

*Shapes Synchronising Fixtures:* A shape with lots of fixtures could get out of sync from fixture to fixture. This is now fixed

*Corrupt Shape Display:* The shape display for bpm could become corrupt if the size was 0. This is now fixed

*Xml Loading:* Loading the xml file would not work correctly and display errors. This is now fixed

*Shortcuts Loading:* Shortcuts would not load correctly after the software was restarted. This is now fixed

*Desk Crashes With Full DMX Complement:* If every dmx line on the desk was patched and then a fixture was parked and repatched twice the desk would crash. This is now fixed

*Attribute Times Menu:* The attribute times menu uses the wrong attribute name. This is now fixed

*Saving Locks:* Locked handle information was not being saved with the show. This is now fixed

*Busking Quick Palettes:* When using busking times and fixture overlap on a quick palette it would fire twice. This is now fixed

*Masters Control Fixture Overlap:* If a mode 1 cue was recorded with fixture overlap, lowering the grand master would not change the intensity but would instead fade out the fixture overlap. This is now fixed

*Shapes Out Of Phase:* If a shape is run for a long period of time across lots of fixtures, it was possible for the fixtures to become out of sync. This is now fixed

*Blind Mode Freeze:* Going into blind mode froze the desk. This is now fixed.

*Include Shape:* Including a shape from a cue with only shape information would not work. Now it does

*Off Palettes:* It was not possible to turn off information in palettes. This is now fixed

*Attribute Table In Programmer:* Picking a value from the attribute table did not add it into the programmer. This is now fixed

*Shapes With Masters:* Intensity shapes would override the grand master. This is now fixed

*Swops Are Laggy:* If you swop playbacks or fixtures furiously fast they will become delayed and slow. This is now fixed

*Flash Buttons Don't Work With Fixture Page:* Flash buttons for fixtures would change with the palette page instead of the fixture page. This is now fixed

*IPCBES Display Issue:* If all of the attributes on the IPCGBES display were in the programmer the display would go blank. This is now fixed

*Stage View With Palettes:* Stage view was not updating palette information correctly. This is now fixed

*Shared Palettes Include:* It was possible to get the shared palette into a state where it would not include anymore. This is now fixed

*Ordering Of Attribute Type:* When in the record by mask menu the IPCGBES would not get added to the display in the correct order. This is now fixed

*Repatch Fixture Adds 1 To Next DMX:* When selecting a fixture to repatch the software would add 1 to the next free dmx channel so there would be gaps between fixtures. This is now fixed

*Groups Get Lost After Fixture Exchange:* After using fixture exchange the groups would no longer select the fixtures correctly. This is now fixed

*Shapes Get Lost After Fixture Exchange:* After using fixture exchange the shapes would no longer run on the fixtures correctly. This is now fixed

*Moving Palette Loads Palette:* When moving a palette it would get loaded if there was a group of fixtures selected. This is now fixed

*Timed Palettes Snapping:* Sometimes when firing a timed palette during the fade of another timed palette it would snap instead of fade. This is now fixed

*Mode 1 Shapes:* Shapes don't fade out correctly in mode 1. This is now fixed

*Fade Out Times In Cue Lists:* Fade out times now work correctly in cue lists

*D4 Crash Using Shapes On Duel Core:* The d4 could crash when programming shapes on a duel core computer. This is now fixed

*Copy Fixture Order:* Fixture order would not get copied when a group of fixtures were cloned. This is now fixed

*Grand Master and Locate:* The grand master would not control located fixtures correctly. This is now fixed

*Selecting Fixture Freeze:* The application could freeze when shift+fixture swop was pressed. This is now fixed

*Timed Palettes In Programmer:* Timed palettes would get added to the programmer when they shouldn't. This is now fixed

*Shape Interpolation:* Shapes were running noticeably jerky when going very slow. The interpolation between points has been increased to fix this.

*Swapping Cues Fires Palettes:* It was possible to get the desk into a state where swapping cues would fire certain palettes if they had been held down. This is now fixed

*Adjusting Speed/Xfade of Running Chases:* When you adjust the speed of a running chase it does not change smoothly. This is now fixed

*Odd Behaviour With Intensity Levels:* The dimmer level can some times jump as if it were being multiplied by 10. This sometimes occurs when you wind the dimmer in to less than 10 % and press that fixtures flash button, or set the master level. This is now fixed

*Chases:* There were problems in the source code that would cause chases to behave erratically. This is now fixed

*Partial XFade of Chases Causes Strobing:* Setting the XFade of chases to anything but 0 or 100% could cause strobing. This is now fixed

*Live Recording:* There have been more fixes to recording a cue whilst it is live.

*Re-fire During Fade Out:* There were some problems with re-firing a cue during fade out where the cue would snap back to 0. This is now fixed

*Re-fire During Fade Out 2:* If a cue was re-fired during fade out, then killed again whilst fading in, the timing would get confused and the cue could snap to 0 half way through the fade. This is now fixed

*Swop Latched On:* If swopping a mode 1 cue with a fade in and fade out time, the cue would stay on after you released the swop button for as long as you had held the button down. This is now fixed

*HTP Channels In Chases:* HTP channels in chases would not fade out in the next cue if any of the fixture channels were recorded into the next cue. This is now fixed

*Entering Time Values In Playback View:* Entering time values in the playback view was not working correctly. This is now fixed

*Attribute Times With Fixture Overlap:* Attribute times were not working with fixture overlap. The times would conflict and cause the cue to run longer than it should. This is now fixed

*Mode 1 Fades:* Mode 1 fades would carry on when the fader was pulled down. This is now fixed

*Copy Shape Fixture:* When copying a fixture it now copies into the shape and at the same fixture position

*Crash Autoloading Self:* The desk could crash when a playback autoloaded itself. This is now fixed

*Fan 1 Fixture:* If you fan 1 fixture you could not change any values. This is now fixed

*Fixture Controls:* Changing control values on a fixture that don't exist slowed down console. This is now fixed

*Replacing Shared Palettes:* Replacing a shared palette doesn't store for all fixture types. This is now fixed

*Dimmer Functions:* Having more than one function in the Dimmer attribute causes the user to be unable to correctly record that attribute to a Playback. This is now fixed

*Palette Fades:* Long timed palette fades override more recent palettes. This is now fixed

*Fixture Exchange Dimmer:* Exchanging to certain fixtures would force dimmer values to 0%. This is now fixed

*Fixture Exchange CMY RGB:* CMY to RGB would not exchange correctly. This is now fixed

*Fixture Exchange Crash:* Fixture exchanging to certain fixtures crashed the desk. This is now fixed

*Fixture Exchange Not Working:* Some fixtures would not exchange at all. This is now fixed

*Fixture Exchange Range:* Different ranged controls don't map correctly in exchange. This is now fixed

*Fixture Exchange Multiple RGB:* Colours would not exchange to a fixture with multiple CMY or RGB values. This is now fixed

*Fixture Exchange Error:* Certain fixtures would bring up an error message when exchanged. This is now fixed

*Fixture Exchange Backwards Range:* Backwards ranges don't exchange. This is now fixed

*Fixture Exchange Wrong Colour:* Sometimes CMY would try to map to RGB instead and not work. This is now fixed

*Fixture Exchange No Attributes:* Attributes that are not in the new fixture get lost in fixture exchange. This is now fixed

*Masters Controlling Swop:* Masters could occasionally lose control of swapped fixtures. This is now fixed

*Preset Swop:* Preset swop keys release each other. This is now fixed

*Shape Controls:* Shapes process controls that don't exist, therefore slowing down processing. This is now fixed

*Block Shapes:* Using block shapes could cause a slow down. This is now fixed

*Shape Channels:* Sometimes shapes would run on the wrong channels on certain fixtures. This is now fixed

*Memory Leaks:* There were some memory leaks that caused a minor slow down. This is now fixed

## **Known Issues**

*Next Timecode Cue:* When running timecode the next cue in the cue list view will be wrong

*Unfold Set Times:* When using set times in unfold if you press the swop of another unfolded cue without exiting the set times menu it will set times for the playback outside of unfold

*Save Override:* When using override to save shows you will get 2 copies of the show saved

*Deleting By Dmx Address:* When deleting by dmx address the line will



revert back to 'A' if the address number is set and one of the last 4 lines is currently selected

*Preload Times:* Preload goes by cue time instead of the set 2 seconds. However this can be overridden by inputting a time and then pressing the swop of the playback to preload.

*Blind Mode:* Dimmer shapes output during blind mode

*Shapes Swop:* If a playback has shape setting of size and speed on fader and it is swopped while the fader is at 0 it will not fire

*Autoload Delay:* Autoload does not wait for the delay time to elapse before firing

Copyright Avolites Limited 2010

Copyright Avolites Limited 2010

# Index

Softkey Menu items are indicated with capital letters (for example "Activate A Timecode Cuelist")

---

## @

- @ button · 32, 140
- @ button, configuring action · 213

---

## 2

- 2-preset mode · 216

---

## A

- Absolute DMX address · 130
- acceleration of wheels · 139
- ACDI · 109
- ACDI, connecting up · 230
- Activate A Timecode Cuelist · 204
- active fixture (AvoTalk) · 237
- Add Swop button · 68, 198
- Align Fixtures · 143
- align function · 34
- All button · 141
- Append · 177, 188
- Append Cue (cue list) · 186
- Apply Time To Palette · 68, 198
- ArtNet, setting up · 231
- As In · 191
- Assign Timecode To Next Cue · 203
- attribute groups · 32, 139
- Attribute Overlap · 181
- attribute ranges · 141
- attribute wheels · 138
- auto restart option · 214
- autosave · 121
- autosave show option · 207
- AvoTalk · 237

---

## B

- backing up show · 122
- backup of show file, creating · 26
- base directory for system files · 214
- Blind button · 171
- BPM option · 209
- busking · 68, 198

---

## C

- Calibrate · 146
- Change DMX Line Mapping · 134
- chase controller A and B · 56, 175
- chases
  - appending new cues · 177

- autoconnect option · 209
- copying · 58, 178
- deleting · 58, 167, 179, 190
- difference between chase and cue list · 185
- editing using unfold function · 58, 177
- global timing · 180
- individual cue times · 181
- inserting a cue · 173
- inserting cues · 177
- pausing · 56, 176
- recording · 55, 173
- running · 56, 174
- setting fixture order for overlap · 182
- setting legends · 57
- speed and crossfade · 56, 176
- tap tempo · 180
- tapping tempo with flash button · 209
- viewing steps on VDU · 177
- viewing timing on VDU · 182, 193
- Clear button · 46, 159
- clearing the console · 123
- colour picker · 200
- Connect button · 56, 175, 187
- Connect Timer · 204
- connecting a chase · 56, 175
- connecting wheels using shortcuts · 199
- Copy Cues From Playback · 179
- copying
  - chase · 58, 178
  - cue · 49, 166
  - cue list · 64, 190
  - fixtures · 132
  - range of items · 166
- copying settings from fixtures · 34, 143
- crossfade of chase · 56, 176
- Cue 1 Use Fade Time · 180, 191
- cue list
  - append cue · 186
  - appending new cues · 188
  - attribute fade times · 192
  - connecting to a controller · 187
  - copying · 64, 190
  - copying a cue · 189
  - cue timings · 64
  - deactivating · 62, 187
  - default delay/fade times · 185
  - deleting · 65, 190
  - difference between chase and cue list · 185
  - editing cues and times · 189
  - editing with unfold · 64
  - from existing cues · 186
  - insert cue · 186
  - inserting cues · 188
  - recording · 61, 185
  - running · 62, 187
  - setting legends · 63
  - setting legends for cues · 186
  - setting times · 191
  - viewing cue times on VDU · 193
  - viewing cues on VDU · 188
- cue lists
  - setting timings · 191
- cue overlap (cue lists) · 192
- cues

attribute fade times · 170  
 changing page · 48, 163  
 copying · 49, 166  
 copying out of chase · 179  
 deleting · 50, 167  
 display of mode · 169  
 editing · 50, 164  
 editing shapes in cues · 164  
 fade curve · 169  
 fade modes · 169  
 flashing · 162  
 include function · 50, 51, 164  
 playing back · 162  
 recording · 47, 161  
 recording in blind mode · 171  
 recording onto preset faders · 161  
 removing attributes · 165  
 setting fade times · 51, 167  
 setting legends · 49, 161  
 triggering by MIDI · 171  
 Curve (dimmer curve) · 144  
 curves, dimmer and fade · 218

---

## D

Default Delay/Fade Times · 185  
 Define Stage · 146  
 Delay Time · 168  
 Delete a DMX channel · 132  
 Delete Cues From Playback · 179  
 deleting  
   chase · 58, 167, 179, 190  
   cue · 50, 167  
   cue from cue list · 65, 190  
   cue list · 65, 190  
   range of items · 167  
 deleting patched fixtures · 132  
 desk lamps · 110  
 desktop editor software · 16, 115  
 DHCP · 242  
 Diamond 4 desktop · 226  
 Dim@ button · 143  
 dimmer curves · 218  
 dimmer, virtual · 139  
 dimmers  
   controlling · 29  
   curve (displaying) · 112  
   deleting dimmer from handle · 132  
   patching · 20, 128  
   setting curve · 144  
   setting levels on keypad · 143  
 DMX address  
   displaying for fixture · 128  
   setting for fixture · 129  
 DMX nodes · 229  
 DMX output lines, mapping · 134  
 DMX outputs · 109  
 DMX over ethernet, configuring · 214  
 DMX View window · 113  
 DVI port · 110

---

## E

Edit Fixtures · 130  
 editing a cue · 50, 164  
 editing shapes · 43  
 Editor · 46, 159  
 eDMX · 235  
 effects generator · 41, 153  
 Elite console  
   differences · 116  
   using top faders · 29, 138  
 Enable Cuelist For Timecode · 203

ethernet, configuring DMX outputs · 229  
 examples  
   chase problems · 59  
   inserting a cue into a cue list · 65  
   moving and setting colour on Mac600 · 35  
   patching Mac600 · 27  
   rainbow shape · 44  
   recalling position palette · 39  
   why don't fixtures move to the cue position · 53  
 examples  
   patching dimmers · 27  
 examples  
   controlling dimmers · 35  
 examples  
   setting position palette · 39  
 examples  
   position shape · 44  
 examples  
   recording a dimmer cue · 53  
 examples  
   using include · 53  
 examples  
   recording a dimmer chase · 59  
 examples  
   recording a cue list · 65  
 EzDmx · 236

---

## F

fade curves · 218  
 Fade Out Time · 168  
 Fade Time · 168  
 fade times for cues · 51, 167  
 fader trigger point, setting · 211  
 faders, level matching when  
   changing pages · 138  
 fading palettes over time · 68, 198  
 Fan button · 34, 145  
 firing a chase · 56, 174  
 Fixture Bank buttons · 30, 138  
 Fixture button · 143, 144  
 Fixture button (above Add Swop button) · 68, 198  
 fixture exchange · 135  
 Fixture Macros · 145  
 fixture number · 133  
 fixture order · 169, 193  
 Fixture Overlap · 168  
 Fixture Overlap (chases) · 181, 193  
 Fixture Overlap (cue lists) · 192  
 fixture overlap (palettes) · 68, 198  
 fixture overlap, setting fixture order · 169  
 fixture personalities, downloading and installing · 222  
 fixtures  
   changing page · 30, 138  
   going back to previous selection · 141  
   groups · 33, 141  
   inverting selection · 145  
   lamp on · 30  
   locating · 30, 137  
   patching · 22, 128  
   reselecting fixtures which are using a certain palette · 142  
   selecting · 29, 137  
   striking lamps or resetting with macros · 145  
 Flip button · 143  
 function wheels · 32, 139

---

**G**

Generic fixtures · 223  
 global chase timing · 180  
 Go button · 63, 187  
 Go button (chases) · 182  
 Go Page button · 48, 163  
 Goto button · 176  
 Grand master · 67, 197  
 grouping fixtures · 33, 141

---

**H**

handle · 19, 127  
 hardware check · 217  
 heartbeat LED · 13, 120  
   disabling · 214  
 heldover playback · 163  
 HiLight button · 142  
 HiLight, recording custom highlight  
   state · 142  
 Hold attribute value · 141  
 Hold Selected Fixtures · 145  
 hotkeys · 215  
 HTP and LTP, explanation of · 45,  
   162

---

**I**

Include button · 50, 51, 164  
 Initial Offset · 156  
 Input Named Value · 140  
 Insert (in unfold mode) · 177, 189  
 Insert (rec chase) · 177  
 Insert (rec cue list) · 188  
 Insert Cue · 173  
 Insert Cue (cue list) · 186  
 intensity view · 200  
 Intensity View window · 112  
 Intensity, displaying below faders ·  
   130  
 Invert Channels · 134  
 invert fixture selection · 142  
 Invert Fixture Selection · 145  
 IP address, setting · 228  
 IP addressing explained · 239  
 IPCGBES groups · 32, 139

---

**K**

key modes · 67, 197  
 keyboard not working · 23  
 keyboard, external · 110

---

**L**

lamp on · 30  
 latching the copy menu · 166, 167,  
   178, 179, 190  
 latching the rec cue menu · 47, 161  
 legends  
   setting for fixtures/dimmers · 23, 131  
 level matching when changing pages  
   · 138

Link (chases) · 182  
 Load DMX Patch · 121  
 Load Show · 26, 121  
 loading a show · 26, 121  
 Locate button · 30, 137  
 locate fixture · 35, 53  
 Locking attribute value · 141  
 locking playback · 163  
 log file · 214  
 log panel keypresses · 214  
 LoLight button · 142  
 LoLight, recording custom lilight  
   state · 142  
 Loop · 191  
 LTP and HTP, explanation of · 45,  
   162  
 LTP trigger point, setting · 211

---

**M**

Mask, palette · 148  
 master faders, assigning · 197  
 master faders, configuring · 67  
 media thumbnail (AvoTalk) · 237  
 Memory button · 53  
 menu softkeys · 10, 117  
 MIDI  
   triggering cues · 171  
 midi connections · 110  
 midi timecode · 203  
 midi troubleshooting · 125  
 ML Menu button · 145  
 mode 0 - 3 for cues · 169  
 mouse, external · 110  
 move function · 201  
 Moving fixture · 133  
 Multi-DMX fixture · 223

---

**N**

network connection · 110  
 numeric entry · 143

---

**O**

odd and even fixture selection · 142  
 Off button · 165  
 On function · 165  
 Open Timecode Viewer · 205  
 operate mode · 67, 197  
 Options button · 56, 176  
 options, setting · 207  
 overview of console · 9, 116  
 Overwrite Show · 121

---

**P**

page shortcuts · 199  
 pages of cues · 48, 163  
 pages of fixtures · 30, 138  
 pages of palettes · 38, 149  
 Palette Bank buttons · 38, 149  
 palettes · 37, 147  
   creating · 37, 148  
   editing and deleting · 149

fading over time · 68, 198  
 fixture overlap · 68, 198  
 mask function · 38  
 recalling · 38, 148  
 removing attributes · 165  
 setting legends · 38, 149  
 shared and normal · 39, 147  
 timed · 150  
 parked fixture · 129  
 parking fixtures · 131  
 Patch button · 20, 25, 129  
 patch list · 135  
 patching · 19  
   change DMX address · 130  
   copying fixtures · 132  
   deleting dimmer channels · 132  
   deleting fixtures · 132  
   dimmers · 20, 128  
   displaying DMX view window · 21, 128  
   fixtures · 22, 128  
   inverting channels · 134  
   parked fixture · 129  
   printout of addresses · 135  
   setting legends · 23, 131  
   swop pan and tilt · 133  
 Pause & Preload button · 56, 176  
 Pause button (cue lists) · 187  
 pausing a chase · 56, 176  
 pending dimmer · 129  
 phase of shapes · 43, 155  
 Pilot · 226  
 Ping · 242  
 Play Order · 191  
 playback faders · 45  
 playback page legend · 49, 161  
 power switch · 14, 111  
 Preload button · 162  
 Preset Faders Control Fixtures 1-48  
   (49-96) · 138  
 Press To Set Mask · 148  
 Press to show DMX channels · 128  
 problems · 124  
 Programmer · 46, 159

---

## Q

Quick network setting · 228  
 quick palette · 149

---

## R

Random (chases) · 191  
 ranges of attributes · 141  
 rear panel connections · 13, 120  
 Rec Chase button · 55, 173  
 Rec Cue button · 47, 161  
 Rec Cue List button · 61, 185  
 Rec Group button · 33, 141  
 Rec Palette · 148  
 Rec Palette button · 37  
 Rec Step button · 178, 189  
 Rec Times button · 189  
   chases · 180  
 Rec Times button (cue lists) · 191  
 Recall Stage · 146  
 Record (in unfold mode) · 177, 188  
 Record By Channel · 160  
 Record By Fixture · 160  
 record by fixture, channel, mask or  
   stage · 52  
 Record By Mask · 160

Record Shortcut · 199  
 Record Stage · 160  
 Record Stage Hard Cue · 185  
 Release attribute hold · 141  
 Remove Attribute From Programmer  
   · 140  
 Remove Fixture From Programmer ·  
   145  
 Remove Fixtures From Program ·  
   166  
 Remove Group From Program · 166  
 Renumber Cues · 178  
 Repatch a Fixture · 129  
 reset button · 13, 120  
 resolution of VDU screens · 110  
 Reverse (chases) · 191  
 Reverse button · 176  
 Reverse button (cue lists) · 187  
 running a chase · 56, 174

---

## S

safe mode · 67, 197  
 Save Selected Fixtures Only · 148  
 Save Show · 26, 121  
 saving show to hard disk · 25, 121  
 Sel If button · 142  
 Select a DMX line · 129  
 Select by Desk Handle / by Fixture  
   Type · 144  
 Select By User Number · 144  
 Select Cue · 191  
 Select Fix Page button · 138  
 Select Fixture Type · 144  
 Select From Table · 140  
 Select Pal Page button · 149  
 Select User Number · 144  
 selecting a range of fixtures · 137  
 Set A Fixture User Number · 133  
 Set BPM · 154  
 Set Cue Times (in unfold mode) ·  
   177  
 Set Fixture Order · 169, 182, 193  
 Set IPCGBES Times · 170  
 Set Legend button · 23, 38, 49, 131,  
   149, 161  
 Set Masters · 197, 216  
 Set Out Time · 191  
 Set Page Legend · 163  
 Set Part function · 43, 155  
 Set Profile · 197  
 Set Timer Source · 203  
 Set Times · 167  
 set user numbers · 215  
 Set VDU Options · 110  
 setting legends for cue list cues ·  
   186  
 Setup button · 25, 110, 121, 197  
 Setup DMX Outputs · 229  
 Shape button · 42  
 shape generator · 41, 153  
 shapes  
   changing fixture order · 157  
   creating · 42  
   deleting · 157  
   editing · 43  
   editing shapes in cues · 164  
   fading in · 157  
   new LTP rules · 158  
   phase · 43, 155  
   reversing · 157  
   size and speed · 42

shared and normal palettes · 39, 147  
shortcuts · 199  
show file  
  creating a backup · 26  
  saving and loading · 26, 121  
shutting down the console · 14, 111  
simulator · 16, 115  
size of shapes · 42  
Soft Key button · 155  
software, upgrading · 220  
sorting columns on VDU screen · 113  
Speed (chase) · 180  
speed of chase · 56, 176  
speed of shapes · 42  
speed, selecting BPM or seconds · 209  
spread of shapes · 43, 155  
Stage View window · 113  
Start From Last Cue · 192  
status LEDs · 120  
Stop All Active Playbacks · 166  
Swap Pan Tilt · 133  
Switch Off Attribute · 140  
Switch On Attribute · 140

---

## T

tap tempo · 180  
theatre mode · 61, 185  
Thro button · 144  
timecode  
  activating cuelist · 204  
  assigning to cue · 203  
  changing time for cue · 205  
  selecting timer source · 203  
  timecode viewer · 205  
timecode playback · 203  
timed palettes · 198  
tracking mode  
  training · 146  
  turning on or off · 146  
troubleshooting · 124  
turning the console on and off · 14, 111  
two-preset mode · 216

---

## U

Unfold button · 58, 64, 177  
Unknown fixtures · 223  
unlinking chase cues · 181  
Up button · 10, 117  
update personality of patched fixture · 131  
upgrading the software · 220  
UPS · 109  
USB pen drive · 26  
Use Current Show · 121  
Use Time And Date · 121  
User Settings · 207

---

## V

VDU screen  
  connecting · 13, 110  
  garbled display · 110  
  setting resolution · 110  
  sorting columns in windows · 113  
View button (chase controller) · 177  
view menu · 200  
viewing cue list cues on VDU · 188  
virtual dimmer · 139  
virtual panel · 207  
Visualiser · 114  
visualiser, displaying · 207  
voltage selector switch · 13, 109

---

## W

WFG · 175, 187  
wheels  
  acceleration · 139  
  attribute control · 31, 138  
  connecting using shortcut · 199  
  function wheels · 32, 139  
wheels view · 200  
wheels, configuring acceleration · 213  
winamp · 203  
Windows XP embedded · 111  
wipeall · 123

Avolites Diamond 4 Operator's Manual

part number **8200-6050**

Price £30

Additional copies of this manual, together with other useful spares etc. can be purchased through the Avolites On line shop. Visit <http://www.avolites.com> then navigate to Avo Shop from the links on the left hand side.