



**WARRANTY AND SAFETY GUIDE**

	<b>Page</b>
Safety Symbol Guide	2
Approvals and Notice	3
Warranty	4
Important Safety Instructions	5
Cautions	5
Warnings	6
Installation	7
Precautions	8

## SAFETY SYMBOL GUIDE

For your own safety and to avoid invalidation of the warranty all text marked with these symbols should be read carefully.



### CAUTIONS

The lightning flash with square symbol, is intended to alert the user to the presence of un-insulated “dangerous voltage” within the product’s enclosure that may be of sufficient magnitude to constitute a risk of electric shock to persons.



### WARNINGS

The exclamation point within an equilateral triangle is intended to alert the user to the presence of important operating and maintenance (servicing) instructions in the literature accompanying the appliance.



### NOTES

Contain important information and useful tips on the operation of your equipment.



### HEADPHONES SAFETY WARNING

Contain important information and useful tips on headphone outputs and monitoring levels.

**IMPORTANT**

**Please read this manual carefully before connecting your mixer to the mains for the first time.**



AVIS: RISQUE DE CHOC ELECTRIQUE  
- NE PAS OUVRIR



This equipment complies with the EMC Directive 89/336/EEC modified by 92/31/EEC, 93/68/EEC & 98/13/EC and the Low Voltage Directive 73/23/EEC modified by 92/31/EEC

**Product Part Nos:**

**COMPACT4: RW5677**  
**COMPACT10: RW5678**

**For further details contact:**

Harman International Industries Ltd.  
Cranborne House, Cranborne Road  
Potters Bar, Hertfordshire, EN6 3JN, UK

Tel: +44 (0) 1707 665000  
Fax: +44 (0) 1707 660742  
e-mail: [info@soundcraft.com](mailto:info@soundcraft.com)

© Harman International Industries Ltd. 2003 All rights reserved

Parts of the design of this product may be protected by worldwide patents.

Part No ZM0293-04 Issue 1.6 Rev. B

Soundcraft is a trading division of Harman International Industries Ltd. Information in this manual is subject to change without notice and does not represent a commitment on the part of the vendor. Soundcraft shall not be liable for any loss or damage whatsoever arising from the use of information or any error contained in this manual.

No part of this manual may be reproduced, stored in a retrieval system, or transmitted, in any form or by any means, electronic, electrical, mechanical, optical, chemical, including photocopying and recording, for any purpose without the express written permission of Soundcraft.



Harman International Industries Limited  
Cranborne House  
Cranborne Road  
POTTERS BAR  
Hertfordshire  
EN6 3JN  
UK

Tel: +44 (0)1707 665000  
Fax: +44 (0)1707 660742  
<http://www.soundcraft.com>

## **WARRANTY**



- 1 Soundcraft is a trading division of Harman International Industries Ltd.  
End User means the person who first puts the equipment into regular operation.  
  
Dealer means the person other than Soundcraft (if any) from whom the End User purchased the Equipment, provided such a person is authorised for this purpose by Soundcraft or its accredited Distributor.  
Equipment means the equipment supplied with this manual.
- 2 If within the period of twelve months from the date of delivery of the Equipment to the End User it shall prove defective by reason only of faulty materials and/or workmanship to such an extent that the effectiveness and/or usability thereof is materially affected the Equipment or the defective component should be returned to the Dealer or to Soundcraft and subject to the following conditions the Dealer or Soundcraft will repair or replace the defective components. Any components replaced will become the property of Soundcraft.
- 3 Any Equipment or component returned will be at the risk of the End User whilst in transit (both to and from the Dealer or Soundcraft) and postage must be prepaid.
- 4 This warranty shall only be valid if:
  - a) The Equipment has been properly installed in accordance with instructions contained in Soundcraft's manual; and
  - b) The End User has notified Soundcraft or the Dealer within 14 days of the defect appearing; and
  - c) No persons other than authorised representatives of Soundcraft or the Dealer have effected any replacement of parts maintenance adjustments or repairs to the Equipment; and
  - d) The End User has used the Equipment only for such purposes as Soundcraft recommends, with only such operating supplies as meet Soundcraft's specifications and otherwise in all respects in accordance with Soundcraft's recommendations.
- 5 Defects arising as a result of the following are not covered by this Warranty: faulty or negligent handling, chemical or electro-chemical or electrical influences, accidental damage, Acts of God, neglect, deficiency in electrical power, air-conditioning or humidity control.
- 6 The benefit of this Warranty may not be assigned by the End User.
- 7 End Users who are consumers should note their rights under this Warranty are in addition to and do not affect any other rights to which they may be entitled against the seller of the Equipment.



## IMPORTANT SAFETY INSTRUCTIONS

### CAUTIONS

Use only the AC adaptor supplied:

UK - HB10058 (C4) or HB10064 (C10)	EU - HB10059 (C4) or HB10065 (C10)
US - HB10060 (C4) or HB10066 (C10)	KR - HB10067 (C4) or HB10061 (C10)
AZ - HB10068 (C4) or HB10062 (C10)	JP - HB10069 (C4) or HB10063 (C10)

Mains voltage selection

This setting is not adjustable. The AC adaptors are capable of operating at either 230V AC or 115V AC +/- 10%. Check the voltage rating of the AC adaptor before plugging in.

Do not use the AC adaptor for any other purpose.

Replace the complete AC adaptor if the plug, lead or adaptor is damaged.

Refer to the Soundcraft dealer from where the equipment was purchased.

The wires in the mains lead are coloured in accordance with the following code:

	UK & EU	US & CAN
<b>Neutral:</b>	Blue	White
<b>Live:</b>	Brown	Black

As the colours of the wires in the mains lead may not correspond with the coloured markings identifying the terminals in your plug, proceed as follows:

The wire which is coloured Blue or White must be connected to the terminal in the plug which is marked with the letter N.

The wire which is coloured Brown or Black must be connected to the terminal in the plug which is marked with the letter L.

Ensure that these colour codings are followed carefully in the event of the plug being changed.

NOTE: This equipment has been tested and found to comply with the limits for a Class B digital device, pursuant to Part 15 of the FCC Rules. These limits are designed to provide reasonable protection against harmful interference in a residential installation. This equipment generates, uses and can radiate radio frequency energy and, if not installed and used in accordance with the instructions, may cause harmful interference to radio communications. However, there is no guarantee that interference will not occur in a particular installation. If this equipment does cause harmful interference to radio or television reception, which can be determined by turning the equipment off and on, the user is encouraged to try to correct the interference by one or more of the following measures:

- Reorient or relocate the receiving antenna.
- Increase the separation between the equipment and receiver.
- Connect the equipment into an outlet on a circuit different from that to which the receiver is connected.
- Consult the dealer or an experienced radio/TV technician for help.

This Class A digital apparatus meets the requirements of the Canadian Interference-Causing Equipment Regulations.

Cet appareil numérique de la Classe A respecte toutes les exigences du Règlement sur le matériel brouilleur du Canada.

## WARNINGS

- Read these instructions.
- Keep these instructions.
- Heed all warnings.
- Follow all instructions.
- This unit contains no user serviceable parts. Refer all servicing to a qualified service engineer, through the appropriate Soundcraft dealer.
- Clean the apparatus only with a dry cloth.
- Do not install near any heat sources such as radiators, heat resistors, stoves, or other apparatus (including amplifiers) that produce heat.
- Do not use this apparatus near water. The apparatus must not be exposed to dripping or splashing. Objects containing liquid must not be placed on the apparatus.
- The disconnect device is the mains plug; it must remain accessible so as to be readily operable in use.
- Do not defeat the safety purpose of the polarized or grounding type plug.  
A polarized plug has two blades with one wider than the other. A grounding type plug has two blades and a third grounding prong. The wide blade or the third prong are provided for your safety. When the provided plug does not fit into your outlet, consult an electrician for replacement of the obsolete outlet.
- Protect the power cord from being walked on or pinched particularly at plugs, convenience receptacles and the point where they exit from the apparatus.
- Only use cables and hardware specified by the manufacturer.
- Unplug this apparatus during lightning storms or when unused for long periods of time.
- Refer all servicing to qualified service personnel. Servicing is required when the apparatus has been damaged in any way such as power-supply cord or plug is damaged, liquid has been spilled or objects have fallen into the apparatus, the apparatus has been exposed to rain or moisture, does not operate normally or has been dropped.
- It is recommended that all maintenance and service on the product should be carried out by Soundcraft or its authorised agents. Soundcraft cannot accept any liability whatsoever for any loss or damage caused by service, maintenance or repair by unauthorised personnel.
- If a trolley is used to carry multiple , use caution when moving the trolley / apparatus combination to avoid injury from tip-over.



## **INSTALLATION**

### **ABOUT THIS MANUAL**

This manual describes the safety precautions, warnings, specifications, installation and operating procedures specific to the following Soundcraft products only:

Soundcraft COMPACT4	RW5677 UK / EU / US / KR / AZ / JP
Soundcraft COMPACT10	RW5678 UK / EU / US / KR / AZ / JP

The information in this manual should be read by end users of one of the above products only. In particular, this manual should not be read in conjunction with any other product not listed above.

The above products do not contain any user-serviceable parts and the user guide does not contain any technical servicing information. Qualified service personnel can obtain a separate Technical Manual incorporating the user guide, Part No ZM0293-01 from Soundcraft or one of its accredited distributors.

Information in this manual is subject to change without notice and does not represent a commitment on the part of the vendor. Soundcraft shall not be liable for any loss or damage whatsoever arising from the use of information or any error contained in this manual.

### **INSTALLING THE MIXER**



Correct connection and positioning of your mixer is important for successful and trouble-free operation. The following sections are intended to give guidance with cabling, connections and configuration of your mixer.

- Choose the mains supply for the sound system with care, and do not share sockets or earthing with lighting dimmers.
- Position the mixer where the sound can be heard clearly.
- Run audio cables separately from dimmer wiring, using balanced lines wherever possible. If necessary, cross audio and lighting cables at right angles to minimise the possibility of interference. Keep unbalanced cabling as short as possible.
- Check your cables regularly and label each end for easy identification.

## **PRECAUTIONS**

### **SAFETY PRECAUTIONS**

For your own safety and to avoid invalidation of the warranty please read this section carefully.

In particular, you should also read the Cautions and Warnings on pages 5-6 of this manual.

### **GENERAL PRECAUTIONS**

Avoid storing or using the mixer in conditions of excessive heat or cold, or in positions where it is likely to be subject to vibration, dust or moisture.

Keep the mixer clean using a soft dry brush, and an occasional wipe with a dry cloth. Do not use any other solvents which may cause damage to paint or plastic parts.

Avoid placing drinks or smoking materials on or near the mixer. Sticky drinks and cigarette ash are frequent causes of damage to connectors, rotary controls and switches.

Regular care and inspection will be rewarded by a long life and maximum reliability.

**When using mains power, the console must only be connected to the Mains Voltage indicated on the power supply.**



**CONTENTS**

	Page
Compact User Interface	10
The 10 Second Tutor	11
Introduction	12
Working Safely with Sound	13
The Mixer Explained	14-15
Mixing Audio Path	16
Monitoring Audio Path	17
Wiring Up	18-20
Problem Solving	21
Mono Input Channels	22-24
Stereo Input Channels	25
Master Section	26-28
Using Your Compact4/10 Console	29
Monitoring Tips	29
Channel Set-Up	30
Operational Notes	31
Application 1 : Computer Based Recording	32
Application 2 : Live performance Mixing	33
Application 3 : DJ Performance Mixing	32
Application 4 : Electronic News Gathering	33
Application 5 ; Broadcast Studio	34
Application 6 : House of Worship	34
Further Information	35
Glossary of Terms used	36
Typical Specifications	37
Compact 4 Dimensions	38
Compact 10 Dimensions	39
Typical Connecting Leads	40-41
System Block Diagram	42
Gain Structure Diagram	43
Compact 4 Mark-Up Sheet	44
Compact 10 Mark-Up Sheet	45

## COMPACT USER INTERFACE

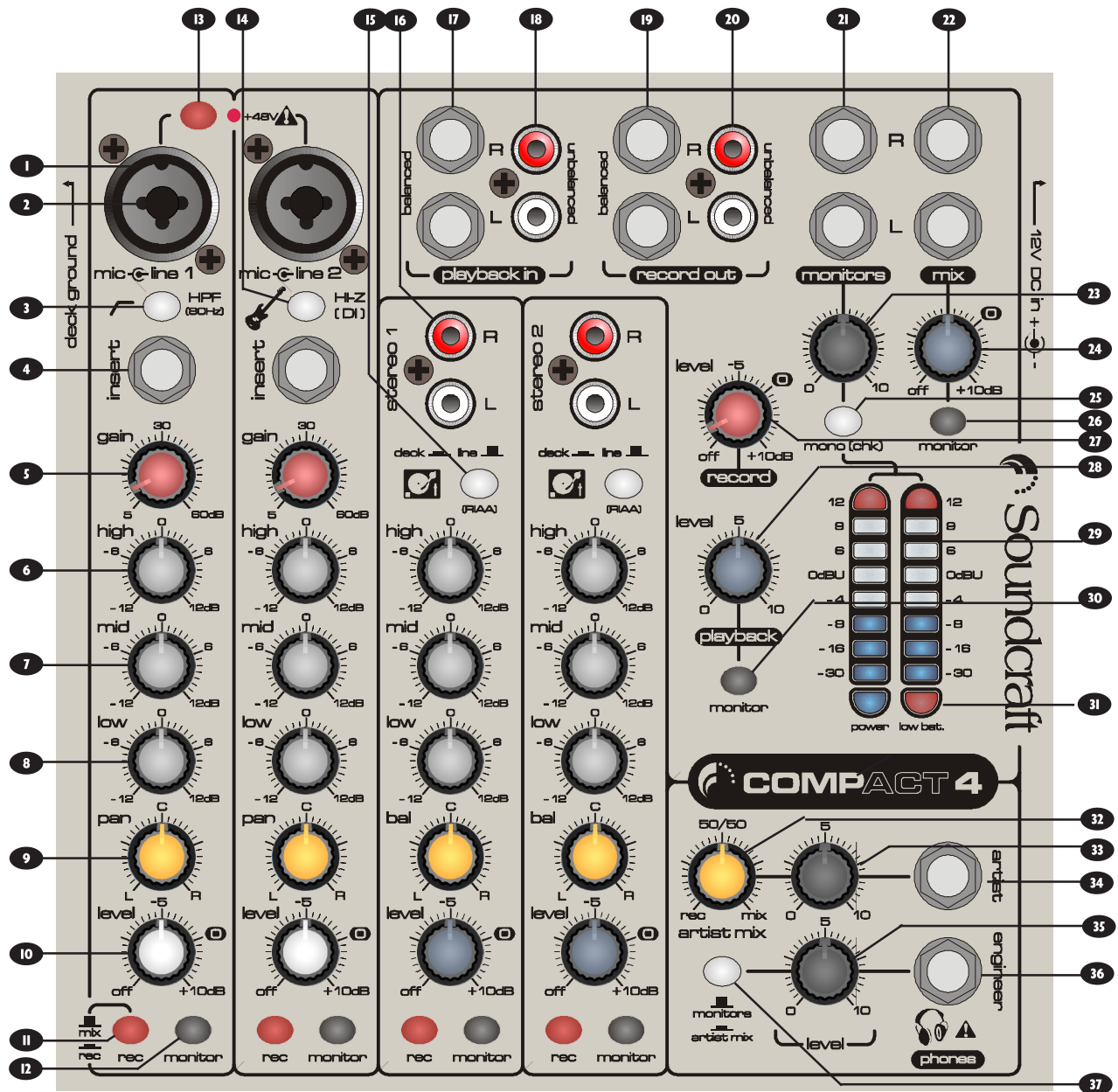

To get you working as fast as possible, this manual begins with a 10 second tutorial. Here you can find quick information on any feature of the console, and a page reference where you can find a more detailed explanation. Just pick out the feature you need more information on, find the associated number and read the brief explanation on the opposite page. More detail can be found by delving deeper into the user guide.

Owners of Compact10 consoles will notice additional jack inputs on Stereo Channels 1-4, these can be used for line level inputs from synthesisers, samplers, drum machines etc.

NOTE: ALL SETTINGS ARE SHOWN IN THEIR DEFAULT POSITION - I.E. THE MOST COMMON SETTINGS TO BEGIN A SESSION

## THE 10 SECOND TUTOR - COMPACT4 / COMPACT 10

- 1** MIC INPUT Connect Microphones here - read phantom power notes before use (pg 22)
- 2** LINE INPUT Connect Line level sources here, e.g. Synth, Drum Machine, etc (pg 22)
- 3** HIGH PASS FILTER This is used to remove very low frequencies i.e. mic "popping" (pg 22)
- 4** INSERT POINT Connect Signal processors here, e.g. Compressor, Gate etc (pg 23)
- 5** GAIN CONTROL Adjust this to increase or decrease the level of the incoming signal (pg 23)
- 6** **7** **8** EQ STAGE Adjust these controls to change the signal tone (the character of the signal) (pg 23)
- 9** PAN CONTROL Use this control to position the signal within the stereo field (pg 24)
- 10** INPUT CHANNEL LEVEL This is used to control the level fed to the Mix Bus (pg 24)
- 11** REC(ORD) SWITCH This sends the channel being recorded to the record outputs, or the Mix Bus (pg 24)
- 12** MONITOR SWITCH Press this to listen to the associated signal (pg 24)
- 13** PHANTOM POWER  Switches on the phantom power (48V) for condenser microphones (pg 22)  
**WARNING:** Do Not apply Phantom Power before connecting a microphone
- 14** D.I. SWITCH Direct Injection - Press this to get a better signal match when a bass guitar is used (pg 23)
- 15** R.I.A.A. SWITCH Vinyl Record Deck Compensation - Use only when decks are connected (pg 25)
- 16** STEREO INPUTS These two inputs take audio from keyboards, sound modules, samplers etc (pg 25)
- 17** **18** PLAYBACK INPUTS Here you can connect the playback from your soundcard or recording device (pg 28)
- 19** **20** RECORD OUTPUTS To connect the output from the mixer to your soundcard (or recording device) input (pg 28)
- 21** MONITOR OUTPUTS These are used to feed your speakers / amp, or monitoring system (pg 26)
- 22** MIX OUTPUTS Connect these to your recording device, or to your amplification system when using as a standard mixer, not when using with a computer based system (pg 26)
- 23** MONITOR LEVEL Used to adjust the level sent to your speakers / amp, or monitoring system (pg 26)
- 24** MIX LEVEL Used to adjust the level sent from the mix outputs (pg 26)
- 25** MONO (CHK) SWITCH Use this to hear and check to your mix in mono (pg 26)
- 26** MONITOR MIX Use this to listen to the mix outputs (pg 26)
- 27** RECORD LEVEL Used to adjust the level sent to your soundcard or recording device (pg 28)
- 28** PLAYBACK LEVEL Used to adjust the level coming from your soundcard or recording device (pg 28)
- 29** MAIN METERS These show the level of the signal being monitored (pg 26)
- 30** MONITOR PLAYBACK Use this to listen to the playback signal from your soundcard (pg 28)
- 31** POWER / LOW BAT. Indicators for DC power from the adapter, or the battery pack (pg 26)
- 32** ARTIST MIX This lets the artist choose the amount of playback signal required (pg 27)
- 33** ARTIST LEVEL This controls the level of the signal sent to the artist's headphones (pg 27)
- 34** ARTIST HEADPHONES The artist should plug headphones in here for personal monitoring (pg 27)
- 35** ENGINEER LEVEL This controls the level of the signal sent to the engineer's headphones (pg 27)
- 36** ENGINEER HEADPHONES The engineer should plug headphones in here for standard monitoring (pg 27)
- 37** MONITORS/ARTIST MIX The engineer, using headphones can listen to the monitor signal or the artist mix (pg 27)

## INTRODUCTION

Thank you for purchasing a Soundcraft mixer. We take great pride in our latest addition to our range of mixing consoles - you have taken a step in the right direction and we will be with you all the way.

Owning a Soundcraft console brings you the expertise and support of one of the industry's leading manufacturers, and the results of over three decades of supporting some of the biggest names in the business. Our knowledge has been attained through working in close contact with leading professionals and institutes to bring you products designed to get the best possible results from your mixing.

Built to the highest standards using quality components and surface mount technology, the Compact4 and Compact10 consoles are designed to be as easy to use as possible. We have spent years researching the most efficient methods of control for two key reasons:

- 1) Engineers, musicians, writers and programmers all need to have very few interruptions to the creative process; our products have been designed to be almost transparent, allowing this process to breathe.
- 2) Whether performing or recording, time is a very expensive and rare commodity. Our products have a user interface which is recognised by millions to be the industry standard because of its efficiency.

The sonic qualities of our products are exemplary - some of the same circuits which are used on our most expensive consoles are employed in the Compact4, bringing you the great Soundcraft quality in a small format console without compromise.

You will also be glad to know you have a one year warranty with your product from the date of purchase. The Compact4 and Compact10 consoles have been designed using the latest high-end software based engineering packages. Every console from Soundcraft has been proven to stand up to all the stress and rigours of modern day mixing environments.

The Compact4 and Compact10 consoles are manufactured using some of the most advanced techniques in the world, from high density surface mount PCB technology, to computer aided test equipment able to measure signals well outside the range of normal hearing.

As each console passes through to the quality checking stage (just before packing), there is also a human listening station. Something we have learnt over the years is that the human touch counts - and only by using people can you ensure the product meets the high demands of the user.

NOTE : The packaging which your Soundcraft Compact4 or Compact10 arrived in forms part of the product, and must be retained for future use.

## WORKING SAFELY WITH SOUND



Although your new console will not make any noise until you feed it signals, it has the capability to produce sounds which when monitored through an amplifier or headphones can damage hearing over time.

The table below is taken from the Occupational Safety & Health Administration directive on Occupational noise exposure (1926.52):

### PERMISSABLE NOISE EXPOSURE

DURATION PER DAY, HOURS	SOUND LEVEL dBA SLOW RESPONSE
8	90
6	92
4	95
3	97
2	100
1.5	102
1	105
0.5	110
<0.25	115

Conforming to this directive will minimise the risk of hearing damage caused by long listening periods. A simple rule to follow is the longer you listen the lower the average volume should be.

Please take care when working with your audio - if you are manipulating controls which you don't understand (which we all do when we are learning), make sure your monitors are turned down. Remember that your ears are the most important tool of your trade, look after them, and they will look after you.

Most importantly - don't be afraid to experiment to find out how each parameter affects the sound - this will extend your creativity and help you to get the best results.

## **THE MIXER EXPLAINED**

### **What is an audio mixer ?**

The term “mixing” is the combining of audio channels, in most cases to form a stereo output signal made up of left and right channels. Mixers normally have level controls (or faders) on each input to set the required amount of audio before the mixing stage

### **What other functions can a Compact mixer perform ?**

The Compact4 and Compact10 consoles can also be used to process audio. You can:

- a) Apply Equalisation ( change the tone of the audio ). This is done using the EQ controls for the low, mid and high bands.
- b) Place an audio processor over a particular signal, this is achieved using the insert point to perform additional processing such as compression, or adding fx such as reverb.
- c) Control the audio position within the stereo field (the sound stage created by your speakers/monitors).
- d) Increase or decrease the incoming signal level in order to achieve the best signal to noise ratio (audio quality). This parameter is known as “gain”.

The Compact4 and Compact10 consoles can also be used to route audio, you can:

- a) Send audio to record outputs, normally fed to your recording system. The source can be unbalanced for use with consumer soundcards, or balanced for professional soundcards.
- b) Send audio to the mix output, used to feed a PA when performing.

The term “monitoring” can be more simply described as listening to audio channels. Mixers normally have monitor switches in various parts of the mixing process to check channels, before and after mixing.

The Compact4 and Compact10 consoles can also be used to monitor (using ears and eyes) audio. You can:

- a) Send audio to the LED meters and the monitor outputs simultaneously. You always see what you hear from your monitor outputs which will feed the speakers in your main listening position.
- b) Send audio to the artist headphone output, used to allow the artist to independently control their own personal mix without affecting any other outputs

### **What kind of things can I plug into it ?**

We can't possibly list all of them here, but below are a few of the most common sources:

- a) Microphones, both dynamic and condenser types can be used. Channel One also has a high-pass filter which removes the sub bass frequencies when singing "b" and "p" sounds.
- b) Guitars, there is even a DI circuit to enhance bass guitars, which is located on a mono channel
- c) Synths/Keyboards, line level stereo outputs can be fed to the stereo input channels.
- d) Decks, or turntables if you're that way inclined, can be fed to stereo inputs with RIAA Equalisation. The RIAA Equalisation returns the tone of the deck input to that of the original signal (as RIAA-EQ is applied when cutting vinyl).
- e) Computer, both Mac and PC systems have a host audio card, often found on the motherboard. The unbalanced connection from the host (or consumer soundcard) can be connected to the phono playback inputs.
- f) Professional Soundcards, or Digital Audio Workstations can be connected to the 3-pole 'A' gauge balanced jack playback inputs.
- g) CDR/DAT/MD/MP3 - the outputs of these consumer, or professional devices can be connected to the unbalanced phono inputs, or the 3-pole 'A' gauge balanced jack stereo inputs (Compact10 only).
- h) Another mixer, often called a sub-mixer will be used to mix a drum kit, or an orchestral outfit. The outputs of this mixer can be connected to the unbalanced phono inputs, or the 3-pole 'A' gauge balanced jack stereo inputs (Compact10 only).

### **Wow that's a lot of stuff for such a small mixer ?**

Yes it is, you should be happy, you made a good choice.

### **Why don't other manufacturers design consoles like this ?**

- a) Because they are out of touch ?
- b) Because they are not very innovative ?
- c) Because they don't have the experience ?
- d) Because they don't listen to their users ?

Who knows :-)

# MIXING AUDIO PATH

So how does audio get mixed ?

The audio path shown below covers :

- A - The input channel path from the microphone input to the mix bus (where all the signals are mixed together). Remember this is a stereo signal.
- B - The mix bus from input channel level to mix output level
- C - The mix output level control to the mix outputs

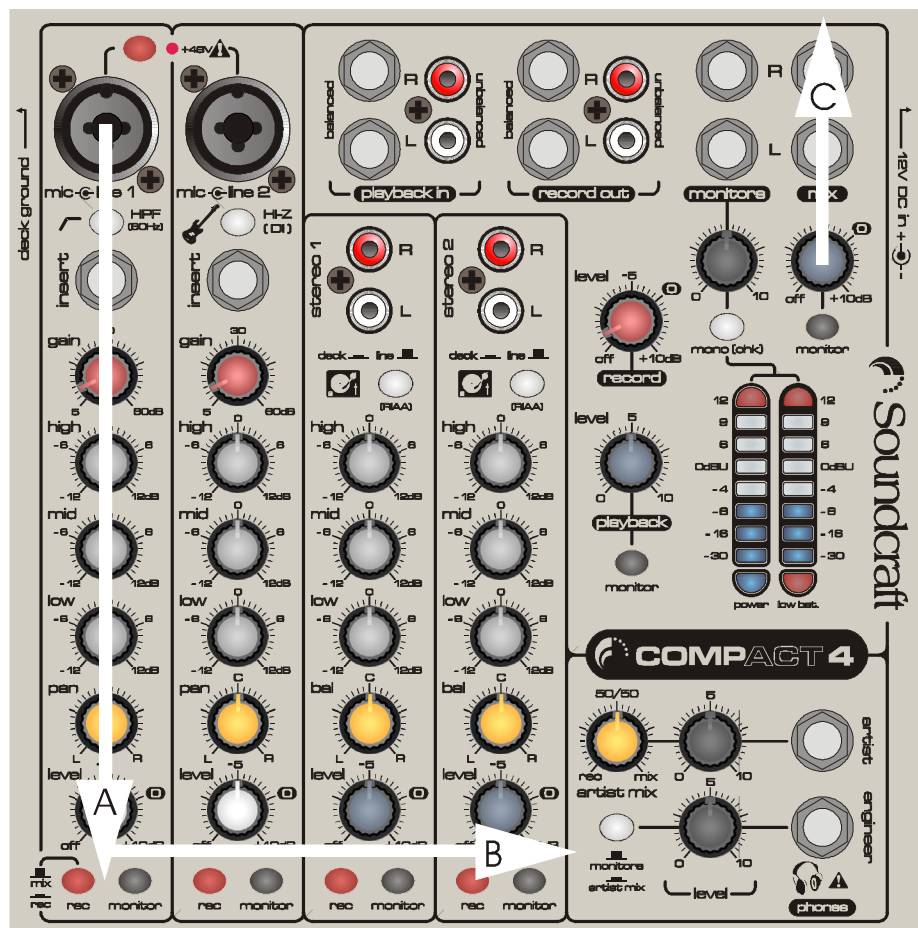



# MONITORING AUDIO PATH

## So how do I listen to audio ?

The audio path shown below covers :

A - The channel monitor button which sends audio (before any pan and level control) to the monitor bus - this is another bus used to add signals for listening. This is normally used to set-up the channel

B - The monitor bus from to monitor output level and headphone output levels

C - The monitor output level control to the monitor outputs

D - The headphone output levels control to the headphone outputs

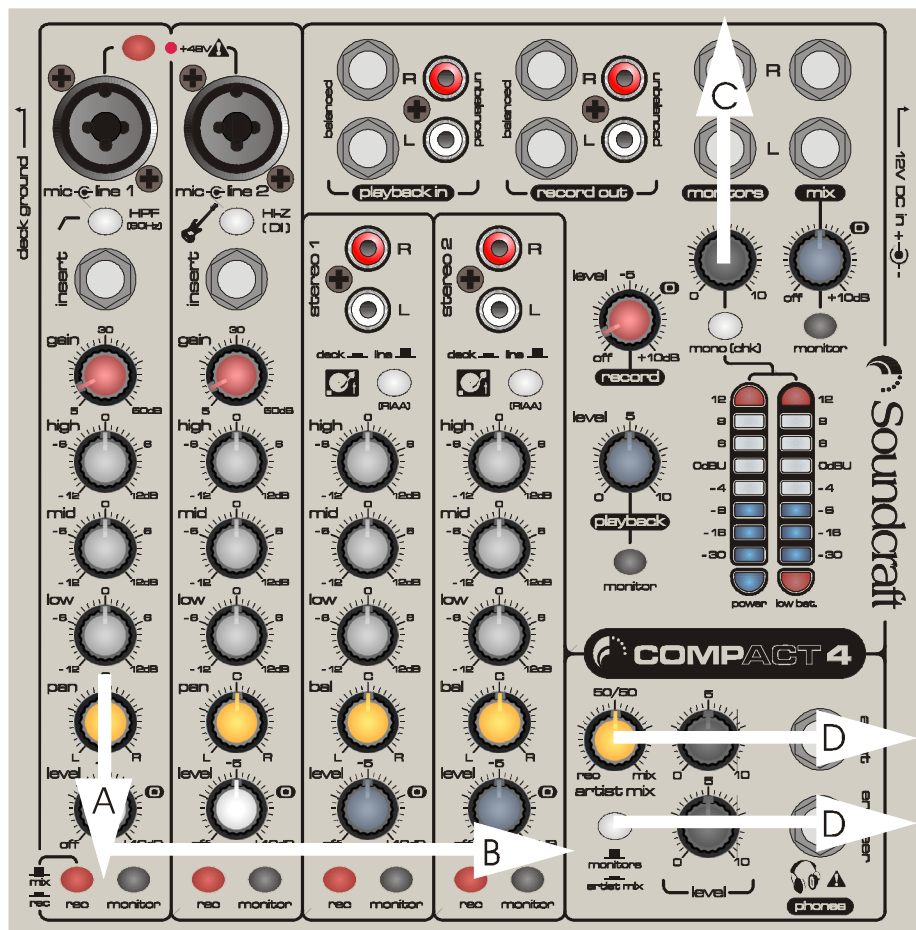

## WIRING UP

### INPUTS

#### Mic Input

The outer ring of the combination input accepts XLR-type connectors and is designed to suit a wide range of BALANCED or UNBALANCED low-level signals, whether from delicate vocals requiring the best low-noise performance, or drum kits needing maximum headroom. Professional dynamic, condenser or ribbon mics are best because these will be LOW IMPEDANCE. While you can use low-cost HIGH IMPEDANCE mics, you do not get the same degree of immunity to interference on the microphone cable and as a result the level of background noise may be higher. If you turn the PHANTOM POWER on, the socket provides a suitable powering voltage for professional condenser mics.

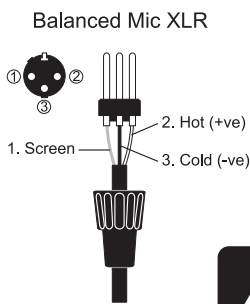

**DO NOT use UNBALANCED sources with the phantom power switched on. The voltage on pins 2 & 3 of the XLR connector may cause serious damage. BALANCED dynamic mics may normally be used with phantom power switched on (contact your microphone manufacturer for guidance)**

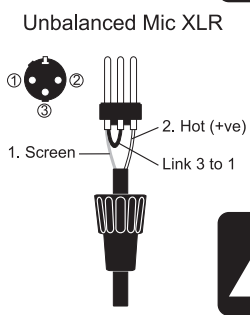

**WARNING !**  
**Start with the input GAIN knob turned fully anticlockwise when plugging high level sources into the LINE input to avoid overloading the input channel or giving you a very loud surprise!**

3 pole jack    2 pole jack  
Balanced    Unbalanced

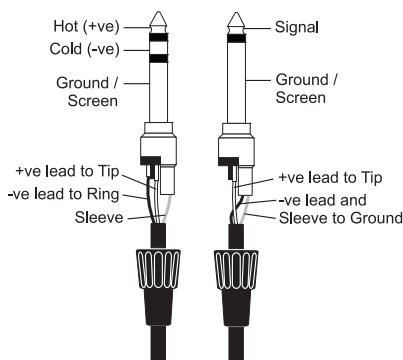

The input level is set using the input GAIN knob.

The LINE input offers the same gain range as the MIC input, but at a higher input impedance, and is 20dB less sensitive. This is suitable for most line level sources.

#### Line Input

The centre of the combination input accepts 3-pole 'A' gauge jacks, or 2-pole mono jacks which will automatically ground the 'cold' input. Use this input for sources other than mics, such as keyboards, drum machines, synths, tape machines or guitars. The input is BALANCED for low noise and immunity from interference, but you can use UNBALANCED sources by wiring up the jacks as shown, although you should then keep cable lengths as short as possible to minimise interference pick-up on the cable. Note that the ring must be grounded if the source is unbalanced. Set the input level using the GAIN knob, starting with the knob turned fully anticlockwise. Unplug any MIC connection when using the LINE input.

#### Inserts

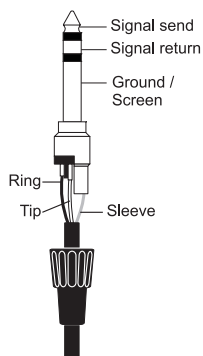

#### Insert Point

The unbalanced, pre-EQ insert point is a break in the channel signal path, allowing limiters, compressors, special EQ or other signal processing units to be placed directly in the signal path. The Insert is a 3-pole 'A' gauge jack socket which is normally bypassed. When a jack is inserted, the signal path is broken, just before the EQ section.

The signal from the channel (often called the SEND) appears on the TIP of the plug and comes back (often called the RETURN) on the RING, with the sleeve as a common ground.

The signal may be also be used to feed as an alternative pre-fade, pre-EQ direct output if required, using a lead with tip and ring shorted together so that the signal path is not interrupted.

**OUTPUTS**

Mix Outputs  
Record Outputs  
Monitor Outputs

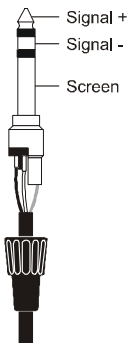

Inserts

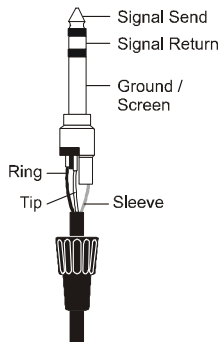

Headphones

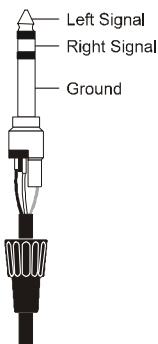

**Using an Insert Cable**

Shown below is the wiring diagram for an insert cable. Your Soundcraft dealer or local distributor should also stock this type of cable.

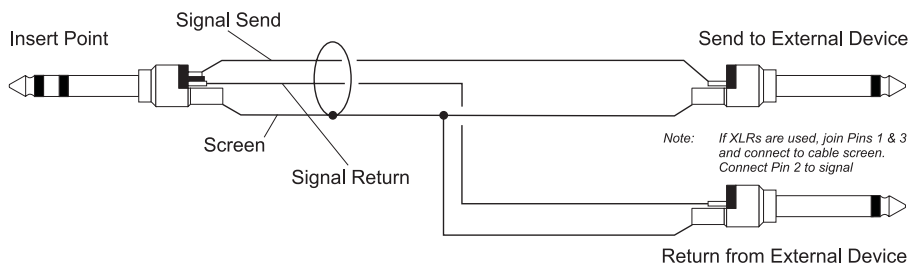

**Stereo Inputs Compact4**

These accept 2-pole phono plugs which will automatically ground the 'cold' input. Use these inputs for sources such as keyboards, drum machines, synths, tape machines or as returns from processing units.

The input is UNBALANCED and you should then keep cable lengths as short as possible to minimise interference pick-up on the cable.

**Stereo Inputs Compact10**

These accept 3-pole 'A' gauge jacks, or 2-pole phono plugs which will automatically ground the 'cold' input. Use these inputs for sources such as keyboards, drum machines, synths, tape machines or as returns from processing units.

The inputs are BALANCED for low noise and immunity from interference, but you can use UNBALANCED sources by wiring up the jacks as shown, although you should then keep cable lengths as short as possible to minimise interference pick-up on the cable. Note that the ring must be grounded if the source is unbalanced.

Mono sources can be fed to both paths by plugging into the Left jack only, and pressing the MONO switch.

NOTE: Please refer to pages 40/41 for additional wiring details.

**Mix Outputs**

The Mix outputs are on 3-pole 'A' gauge jack sockets, wired as shown on the left, and are balanced, allowing long cable runs to balanced amplifiers and other equipment.

**Monitor Outputs**

The Monitor outputs are on 3-pole 'A' gauge jack sockets, wired as shown on the left, and are balanced, allowing long cable runs to balanced amplifiers and other equipment.

## Artist and Engineer Headphones

### OUTPUTS

Mix Outputs

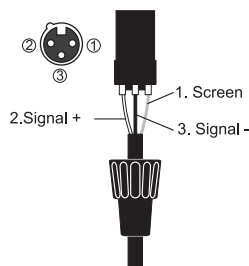

Aux Outputs  
Monitor Outputs

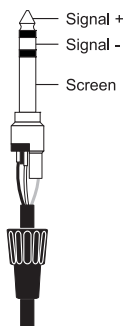

Mix Inserts

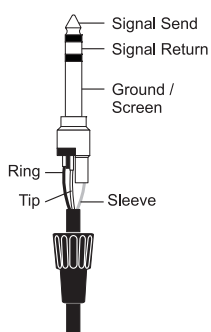

Headphones

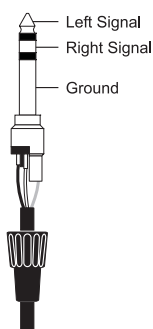

The Headphones outputs are on a 3-pole 'A' gauge jack, wired as a stereo output as shown, The output level is designed ideally for headphones of 200Ω or greater. 8Ω headphones are not recommended, although can be used.

### Polarity (Phase)

You will probably be familiar with the concept of polarity in electrical signals and this is of particular importance to balanced audio signals. Just as a balanced signal is highly effective at cancelling out unwanted interference, so two microphones picking up the same signal can cancel out, or cause serious degradation of the signal if one of the cables has the +ve and -ve wires reversed. This phase reversal can be a real problem when microphones are close together and you should therefore always take care to connect pins correctly when wiring audio cables.

### Grounding and Shielding

For optimum performance use balanced connections where possible and ensure that all signals are referenced to a solid, noise-free earthing point and that all signal cables have their screens connected to ground. In some unusual circumstances, to avoid earth or ground 'loops' ensure that all cable screens and other signal earths are connected to ground only at their source and not at both ends.

If the use of unbalanced connections is unavoidable, you can minimise noise by following these wiring guidelines:

- On INPUTS, unbalance at the source and use a twin screened cable as though it were balanced.
- On OUTPUTS, connect the signal to the +ve output pin, and the ground of the output device to -ve. If a twin screened cable is used, connect the screen only at the mixer end.
- Avoid running audio cables or placing audio equipment close to thyristor dimmer units or power cables.
- Noise immunity is improved significantly by the use of low impedance sources, such as good quality professional microphones or the outputs from most modern audio equipment. Avoid cheaper high impedance microphones, which may suffer from interference over long cable runs, even with well-made cables.

Grounding and shielding is still seen as a black art, and the suggestions above are only guidelines. If your system still hums, an earth/ground loop is the most likely cause. Two examples of how an earth loop can occur are shown below.

Example 1

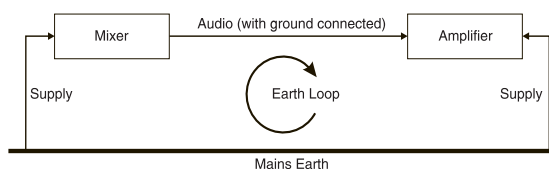

Example 2

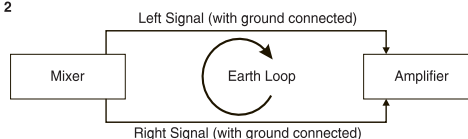

**WARNING! Under NO circumstances must the AC power mains earth be disconnected from the mains lead.**

## PROBLEM SOLVING

Basic problem solving is within the capability of any user if a few basic rules are followed.

- Get to know the Block Diagram of your console (see page 42).
- Get to know what all parameters and/or connections in the system are supposed to do.
- Learn where to look for common trouble spots.

The Block Diagram is a representative sketch of all the components of the mixer, showing how they connect together and how the signal flows through the system. Once you have become familiar with the various component blocks you will find the Block Diagram is quite easy to follow and you will have gained a valuable understanding of the internal structure of the mixer.

Each component has a specific function and only by getting to know what each part is supposed to do will you be able to tell if there is a genuine fault! Many "faults" are the result of incorrect connection or control settings which may have been overlooked.

Basic Troubleshooting is a process of applying logical thought to the signal path through the mixer and tracking down the problem by elimination.

- Swap input connections to check that the source is really present. Check both Mic and Line inputs.
- Eliminate sections of the channel by using the insert point to re-route the signal to other inputs that are known to be working.
- Route channels to different outputs or to auxiliary sends to identify problems on the Master section.
- Compare a suspect channel with an adjacent channel which has been set up identically. Use the MONITOR switches to hear the signal in each section.
- Problems with the Insert jack sockets contacts may be checked by using an insert bypass jack with tip and ring shorted together as shown to the left. If the signal appears when the jack is inserted it shows that there is a problem with the contacts on the jack socket, caused by wear or damage, or often just dirt or dust. Keep a few in your gig tool box.

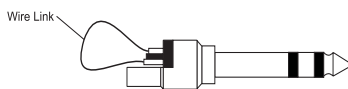

Insert Bypass Jack

If in doubt please contact Soundcraft customer support.

### PRODUCTS UNDER WARRANTY

USA customers should contact the National Service Manager at Soundcraft USA, telephone: (615) 360-0458, e-mail: [soundcraft-usa@harman.com](mailto:soundcraft-usa@harman.com).

UK customers should contact their local Dealer.

Outside the UK and USA, customers are requested to contact their territorial distributor who is able to offer support in the local time zone and language. Please see the Distributor listings on our website (<http://www.soundcraft.com>) to locate your Local Distributor.



### OUT-OF-WARRANTY PRODUCTS

For out-of-warranty mixers purchased in the United Kingdom, please contact the Customer Services Department (e-mail: [csd@soundcraft.com](mailto:csd@soundcraft.com)) at the factory in Potters Bar, Hertfordshire: Telephone +44 (0)1707 665000.

For all other out-of-warranty mixers, please contact the appropriate territorial distributor.

When mailing or faxing please remember to give as much information as possible. This should include your name, address and a daytime telephone number.

Should you experience any difficulty please contact Customer Services Department (e-mail: [csd@soundcraft.com](mailto:csd@soundcraft.com))



# MONO INPUT CHANNELS

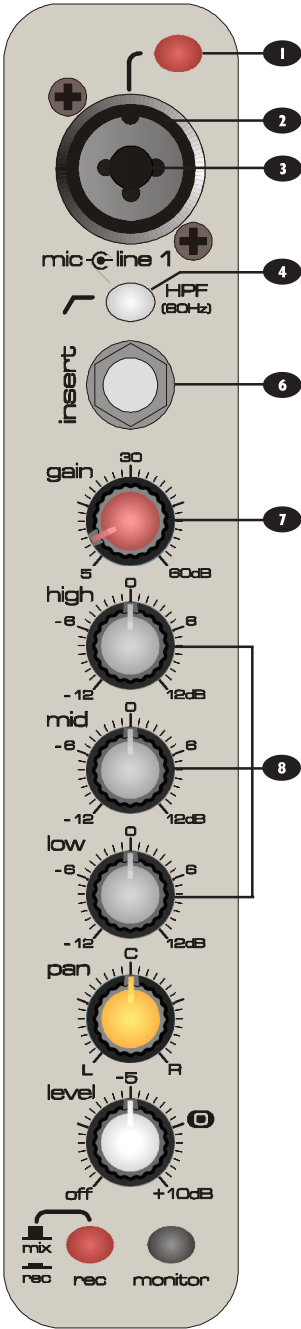

## 1 PHANTOM POWER

When using condenser microphones +48v phantom power is required to be present at the contacts of the microphone (XLR) socket for the microphone to operate correctly. Phantom power can only be applied to both microphone inputs simultaneously so ensure that phantom power is off when not required.

**ONLY connect condenser microphones with the +48V powering OFF, and ONLY turn the +48V powering on or off with ALL OUTPUT LEVEL CONTROLS DOWN, to prevent damage to the mixer or external devices.**



TAKE CARE when using unbalanced sources, which may be damaged by the phantom power voltage on pins 2 & 3 of the XLR connector.

Unplug any mics if you want to use the LINE Input. The input level is set using the GAIN knob as described in point (7).

## 2 MIC INPUT

The MIC input accepts XLR-type connectors and is designed to suit a wide range of BALANCED or UNBALANCED signals. Professional dynamic, condenser or ribbon mics are best because these will be LOW IMPEDANCE. You can use low-cost HIGH IMPEDANCE mics, but the level of background noise will be higher. If you turn the PHANTOM POWER on (top right-hand side of the mixer) the socket provides a suitable powering voltage for professional condenser mics.

## 3 LINE INPUT

Accepts 3-pole 'A' gauge (TRS) jacks. Use this input for sources other than mics, such as keyboards, drum machines, synths, tape machines or DI'd guitars. The input is BALANCED for low noise and top quality from professional equipment, but you can use UNBALANCED sources by wiring up the jacks as shown below, although you should then keep cable lengths as short as possible. Unplug anything in the MIC input if you want to use this socket. Set the input level using the GAIN knob.

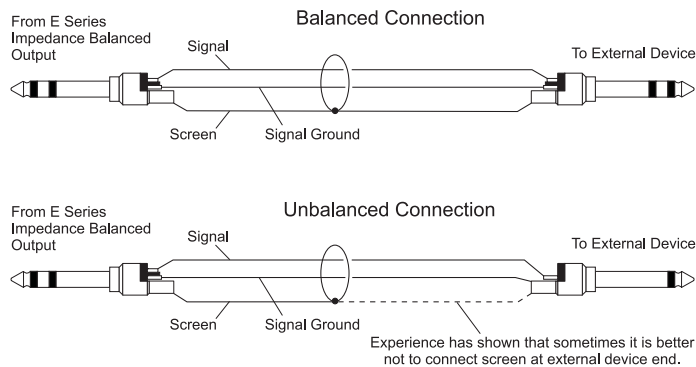

## 4 HIGH PASS FILTER SWITCH

Pressing this switch activates a steep 12dB per octave filter which reduces the level of sub-harmonic bass frequencies. This is very useful for removing mic-pops caused by the large volumes of air pushed out rapidly when singing [P] or [B] sounds. It can also be used to get rid of "rumble" caused by a microphone on stage, or to simply clean up a mix.

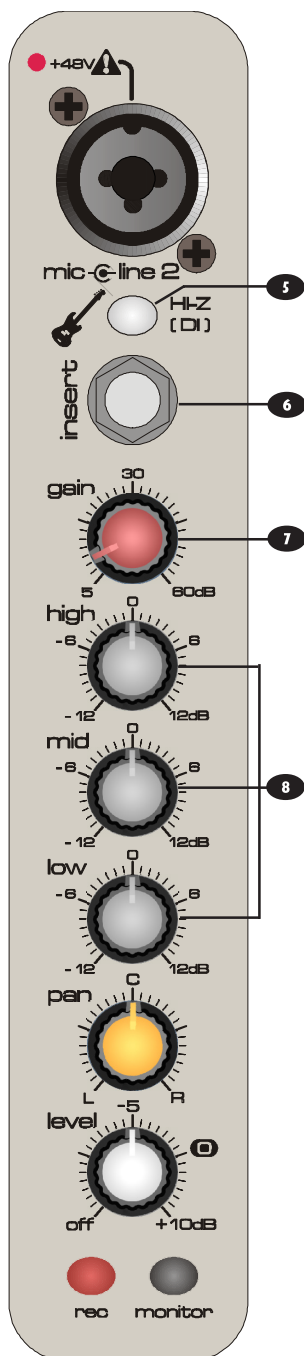

**5 DIRECT INJECTION SWITCH**

This switch activates the high impedance mode for the 3-pole 'A' gauge jack input. The high impedance is used to match the signal from a high-impedance source such as bass guitars. When activating you will notice the guitar sound will become much bolder. Using impedance matching this way for guitar inputs is known as "Direct Injection" When using as bass guitar without the DI switch activated, you may notice a reduction on the high frequencies produced.

NOTE 1- The high pass filter switch is featured on channel 1 of the Compact4, and channels 1&2 on the Compact10. The direct injection switch is featured on channel 2 of the Compact4, and channels 3&4 on the Compact10

**6 INSERT POINT**

The unbalanced, pre-EQ insert point is a break in the channel signal path, allowing limiters, compressors, special EQ or other signal processing units to be added in the signal path. The Insert is a 3-pole 'A' gauge jack socket which is normally bypassed. When a jack is inserted, the signal path is broken, just before the EQ section. The Send may be tapped off as an alternative pre-fade, pre-EQ direct output if required, using a lead with tip and ring shorted together so that the signal path is not interrupted (see pages 18/ 19).

**7 GAIN CONTROL**

This knob sets how much of the source signal is sent to the rest of the mixer. Too high, and the signal will distort as it overloads the channel. Too low, and the level of any background hiss will be more noticeable and you may not be able to get enough signal level to the output of the mixer.

Note that some sound equipment, particularly that intended for domestic use, operates at a lower level (-10dBV) than professional equipment and will therefore need a higher gain setting to give the same output level.

**8 EQUALISER**

The Equaliser (EQ) allows fine manipulation of the sound, particularly to improve the sound in live PA applications where the original signal is often far from ideal and where slight boosting or cutting of particular voice frequencies can really make a difference to clarity. There are three sections giving the sort of control usually only found on much larger mixers. The EQ knobs can have a dramatic effect, so use them sparingly and listen carefully as you change any settings so that you get to know how they affect the sound.

**HF EQ**

Turn to the right to boost high (treble) frequencies above 12kHz by up to 12dB, adding crispness to cymbals, vocals and electronic instruments. Turn to the left to cut by up to 12dB, reducing hiss or excessive sibilance which can occur with certain types of microphone. Set the knob in the centre-detented position when not required.

**MID EQ**

This control knob provides 12dB of boost and cut, just like the HF EQ knob, but at the frequency of 600Hz. The frequency has been chosen to represent a balance covering the range of most vocals. Listen carefully as you use this control to find how particular characteristics of a vocal signal can be enhanced or reduced. Set the knob to the centre-detented position when not required.

**LF EQ**

Turn to the right to boost low (bass) frequencies below 60Hz by up to 12dB, adding warmth to vocals or extra punch to synths, guitars and drums. Turn to the left to cut low frequencies by up to 12dB for reducing hum, stage rumble or to improve a mushy sound. Set the knob to the centre-detented position when not required.

## MONO INPUT CHANNELS - CONTINUED



### 1 PAN

This control sets the amount of the channel signal feeding the Left and Right MIX buses, allowing you to move the source smoothly across the stereo image. When the control is turned fully left or right you are able to route the signal with no gain to either left or right outputs individually.

### 2 CHANNEL LEVEL CONTROL

The rotary level control, with a custom-designed law to give even smoother control of the overall signal level in the channel strip, allows precise balancing of the various source signals being mixed to the Master Section. You get most control when the input GAIN is set up correctly, giving the full rotation of the level control. See the “Initial Setup” section on page 30 for help in setting a suitable signal level.

### 3 MONITOR SWITCH

When the latching MONITOR switch is pressed, the pre-fade signal is fed to the mix, for setting up and making adjustments in isolation from other channels. The monitor signal is a true stereo signal, it does not get summed to a mono bus as in some other, more generic mixers. This means when you monitor a channel the positional information is never lost, you always here a signal how it would appear in the stereo field (the sound stage in front of you reproduced using speakers).

### 4 RECORD SWITCH

When pressed this sends the channel audio out to the record outputs. These record outputs must be connected to your soundcard inputs. There are three advantages of having this feature:

1. You will only ever record the channel/s which have the Record switch pressed. With more complex mixers, a common error is recording additional unrequired instruments, or open channels adding noise to your recording.
2. The artist will not have to deal with the latency of the recording hardware/software. On other, more generic mixers it is common to monitor the recording signal from the computer, this means there is a delay which can be extremely frustrating for all performers, especially drummers, where timing is critical. Using the “zero-latency” monitoring means that the signal is sent to the headphones directly
3. It makes the recording procedure simple and fast to learn, and intuitive to use.



# STEREO INPUT CHANNELS

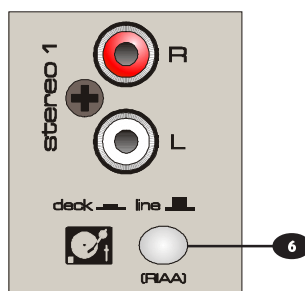
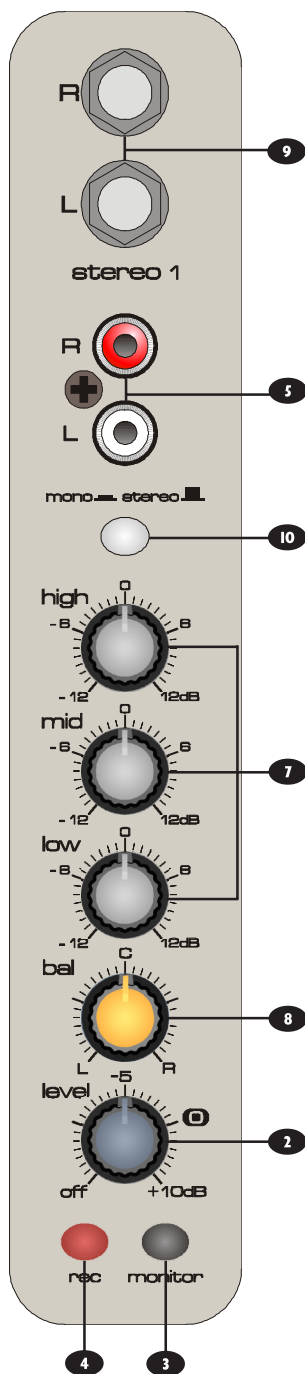

## 5 INPUTS STEREO 1/2

These inputs accept 2-pole Phono plugs. Use these inputs for sources such as keyboards, drum machines, synths, CD/DVD Players, tape machines or processing units. The inputs are UNBALANCED for use with consumer and semi-professional equipment, although you should then keep cable lengths as short as possible.

## 6 RIAA EQUALISATION

When Vinyl is recorded an EQ curve is applied to maximise the dynamic range at the cutting stage. Engaging this switch reverses the EQ curve, returning the signal to its former glory. Use this for turntable inputs which do not have built-in RIAA equalisation.

NOTE: When using turntables, ensure you connect the turntable earth to the earth stud on the left hand side of the console (recessed in the side cheek).

## 7 EQUALISER

### HF EQ

Turn to the right to boost high (treble) frequencies above 12kHz by up to 12dB, adding crispness to cymbals, vocals and electronic instruments. Turn to the left to cut by up to 12dB, reducing hiss or excessive sibilance which can occur with certain types of microphone. Set the knob in the centre-detented position when not required.

### MID EQ

This control knob provides 12dB of boost and cut, just like the HF EQ knob, but at the frequency of 600Hz. Listen carefully as you use this control to find how particular characteristics of a vocal signal can be enhanced or reduced. Set the knob to the centre-detented position when not required.

### LF EQ

Turn to the right to boost low (bass) frequencies below 60Hz by up to 12dB, adding warmth to vocals or extra punch to synths, guitars and drums. Turn to the left to cut low frequencies by up to 12dB for reducing hum, stage rumble or to improve a mushy sound. Set the knob to the centre-detented position when not required.

## 8 BALANCE

This control sets the amount of the channel signal feeding the Left and Right MIX buses, allowing you to balance the source in the stereo image. When the control is turned fully right or left you feed only that side of the signal to the mix. The zero gain is provided by the control in the centre-detented position.

## Compact10 Stereo Channels 1-4

### 9 1/4" 3-pole jack inputs are found on the Compact10 Mixing Console

10 NOTE - The stereo inputs can also be used as a MONO channel. You can do this by pressing the MONO switch, this is found on stereo channels 1-4.

## MASTER SECTION



### 1 MONITOR OUTPUTS

The Monitor LEFT and RIGHT outputs are sent from the 3-pole 'A' gauge jacks sockets as balanced signals.

### 2 MONITOR LEVEL

This control sets the level to the MONITOR LEFT & RIGHT outputs.

### 3 MONO (CHK)

This switch when activated performs a mono sum of the monitor signal so that you can check how your stereo signal would be heard in mono.

### 4 MIX OUTPUTS

The Monitor LEFT and RIGHT outputs are sent from the 3-pole 'A' gauge jacks sockets as balanced signals.

### 5 MIX LEVEL

The MIX level control is used to set the final level of the MIX outputs. These should normally be set close to the '0' mark if the input GAIN settings have been correctly set, to give maximum resolution for the overall signal to noise ratio.

### 6 MONITOR MIX

Pressing this switch will allow you to hear all the signals sent to the MIX bus.

### 7 BARGRAPH METERS

The three-colour peak reading BARGRAPH METERS show the level of the MONITOR RIGHT and MONITOR LEFT outputs, giving you a constant warning of excessive peaks in the signal which might cause overloading.

Aim to keep the signal within the white segments at peak levels for best performance. If the top segment lights RED then you have reached a point where the signal will clip and begin distorting, reduce the input level accordingly.

Similarly, if the output level is too low and hardly registering at all on the meters, the level of background noise may become significant. Take care to set up the input levels for best performance.

When any MONITOR switch is pressed, the meters switch to show the selected MONITOR signal on both meters, in true stereo.

### 8 POWER INDICATOR

This LED lights to show when power is connected to the console.

### 9 LOW BATTERY INDICATOR

This LED will flash red to show when the batteries have reached a dangerously low level and should be replaced by fresh batteries, or mains power as soon as possible.

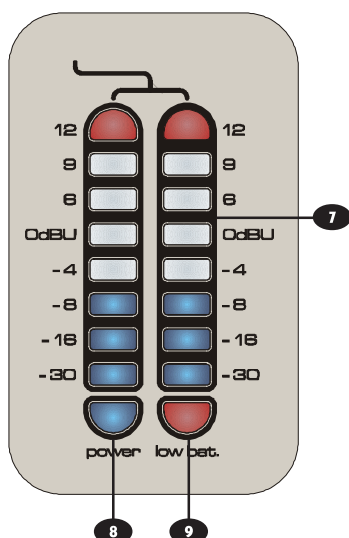

**MASTER SECTION**

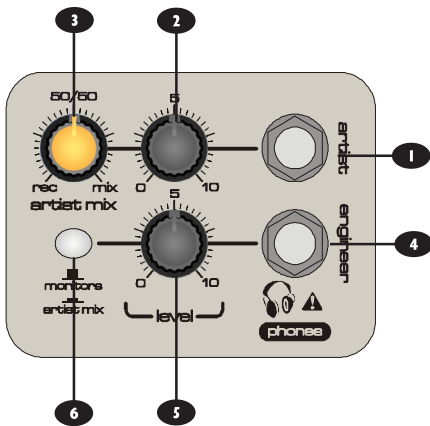

**1 ARTIST HEADPHONES OUTPUT**

The Artist Headphones Outputs are on 3-pole 'A' gauge jacks and are unbalanced connections wired as a stereo output. There is a substantial amount of power at these sockets depending on the type of headphones you use. Remember the higher the impedance of the headphones normally means the louder they will be. The circuit has been designed for use with consumer and professional headphones. Ideally headphones should be 200Ω or greater. 8Ω headphones are not recommended.

**2 ARTIST HEADPHONES LEVEL**

This control sets the output level to the Artist Headphone outputs. If headphones are plugged into the PHONES jack, then the knob sets a comfortable headphone listening level without affecting the Monitor output levels.

**3 ARTIST MIX CONTROL**

This control allows the artist to hear a personal blend of the playback signal and the recorded signal. Some vocalists may want to hear a fairly low level version of their voice and hear much more of the playback so that they can "key" clearly. It can be used to allow the artist a personal mix which effects neither the monitor outputs nor the engineer headphones.

**4 ENGINEER HEADPHONES OUTPUT**

The Engineer Headphones Outputs are on 3-pole 'A' gauge jacks and are unbalanced connections wired as a stereo output. There is a substantial amount of power at these sockets depending on the type of headphones you use. Remember the higher the impedance of the headphones normally means the louder they will be. The circuit has been designed for use with consumer and professional headphones. Ideally headphones should be 200Ω or greater. 8Ω headphones are not recommended.

**5 ENGINEER HEADPHONES LEVEL**

This control sets the output level to the Artist Headphone outputs. If headphones are plugged into the PHONES jack, then the knob sets a comfortable headphone listening level without affecting the Monitor output levels.

**6 MONITOR ARTIST PHONES**

Press this switch to route the Artist Mix signal to the engineer head phones, over-riding the default Monitor/Phones signal. This allows the engineer to hear what the artist is hearing (useful for resolving communication errors between the artist and engineer :-)), or for the engineer to become the artist (a common dual personality problem).

## MASTER SECTION

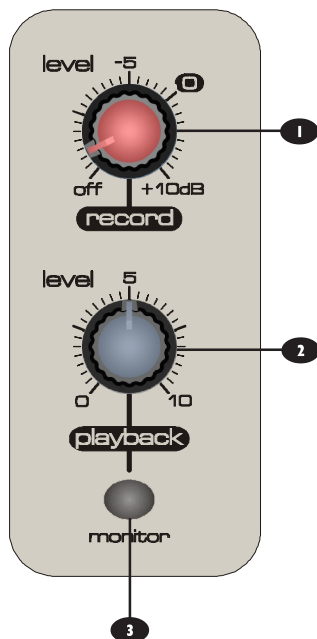

### 1 RECORD OUTPUT LEVEL

This control sets the output level to the RECORD outputs. The input monitor of your soundcard/sequencer should be checked for a good level of signal. If you have followed the set-up procedure, this knob should be around the 0dB position.

### 2 PLAYBACK INPUT LEVEL

This control sets the input level of the playback signal. Again if your soundcard/sequencer is setup correctly, and using maximum resolution you should find this control at the position 7 (0-10).

### 3 MONITOR PLAYBACK

When the latching MONITOR switch is pressed, the post-fade signal is fed to the monitor bus, for setting up and making adjustments in isolation from other channels. The monitor signal is a true stereo signal, it does not get summed to a mono bus as in some other, more generic mixers. This means when you monitor a channel the positional information is never lost, you always hear a signal how it would appear in the stereo field (the sound stage in front of you reproduced using speakers).

### 4 PLAYBACK INPUTS - BALANCED

The Playback LEFT and RIGHT Inputs accept 3-pole 'A' gauge (TRS) jacks. Use these inputs for the outputs from your soundcard/sequencer. The inputs are BALANCED for low noise and top quality from professional equipment, but you can use UNBALANCED sources (see wiring diagram on page 18)

### 5 PLAYBACK INPUTS - UNBALANCED

The Playback LEFT and RIGHT Inputs also accept 2-pole Phono plugs. Use these inputs for the outputs from your soundcard/sequencer. The inputs are UNBALANCED for use with consumer and semi-professional equipment, although you should then keep cable lengths as short as possible.

### 6 RECORD OUTPUTS - BALANCED

The Record LEFT and RIGHT outputs are sent from the 3-pole 'A' gauge jacks sockets as balanced signals.

### 7 RECORD OUTPUTS - UNBALANCED

The Record LEFT and RIGHT Outputs are also available on 2-pole Phono plugs. Use these outputs to send the recording signal to your soundcard or sequencer. The outputs are UNBALANCED for use with consumer and semi-professional equipment, again you should then keep cable lengths as short as possible.

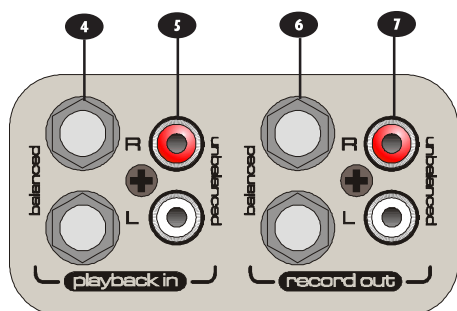

## USING YOUR COMPACT 4/10 MIXER

The final sound from your monitoring system can only ever be as good as the weakest link in the chain, and especially important is the quality of the source signal because this is the starting point of the chain. Just as you need to become familiar with the control functions of your mixer, so you must recognise the importance of correct choice of inputs, microphone placement and input channel settings. However, no amount of careful setting up can take account of the spontaneity and unpredictability of live performance. The mixer must be set up to provide "spare" control range to compensate for changing microphone position and the absorption effect of a large audience (different acoustic characteristics from soundcheck to show).

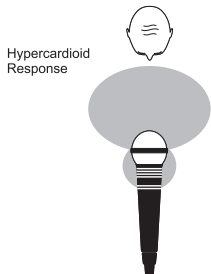
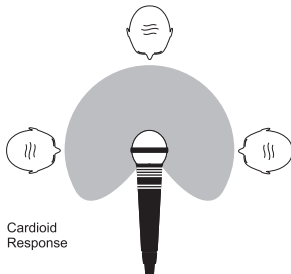

### MICROPHONE PLACEMENT

Careful microphone placement and the choice of a suitable type of microphone for the job is one of the essentials of successful sound reinforcement. The diagrams on the left show the different pick-up patterns for the most common types of microphone. Cardioid microphones are most sensitive to sound coming from in front, and hypercardioid microphones offer even greater directivity, with a small amount of pickup behind the microphone. These types are ideal for recording vocalists or instruments, where rejection of unwanted sounds and elimination of feedback is important. The aim should be to place the microphone as close as physically possible to the source, to cut out unwanted surrounding sounds, allow a lower gain setting on the mixer and avoid feedback. Also a well chosen and well placed microphone should not need any appreciable equalisation.

There are no exact rules - let your ears be the judge. In the end, the position that gives the desired effect is the correct position!

**The front panel drawing on page 10 shows typical initial control positions which is a useful guide to setting up the mixer for the first time.**



### MONITORING TIPS

The diagram below shows how to set-up speakers in a live environment, the front of house speakers are shown, although you should consult your studio monitor manual for precise placement.

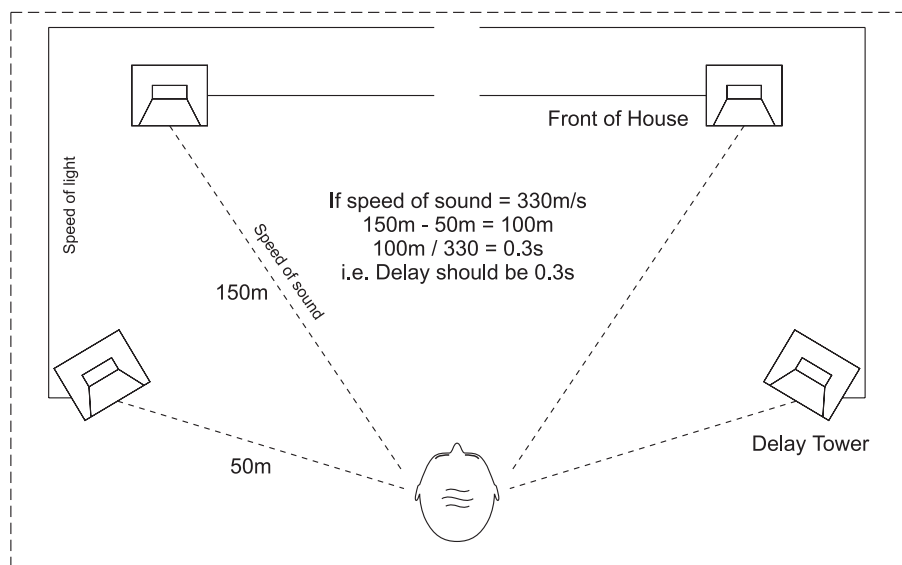

## CHANNEL SET-UP

In order to get the best results from your mixing experience it is vital that you follow one golden rule - GET THE SIGNAL LEVEL RIGHT FROM THE INPUT.

By pressing the MONITOR button on an input channel you can hear the channels audio and see the level on the meters.



Ensure the EQ is flat, so that the signal is unaffected.

Mono Channels - Adjust the gain until the signal is just below the point where it triggers the red LED on the meters.

Stereo Channels - Adjust the output level on the sending device until the signal is just below the point where it triggers the red LED on the meters.

This method will always ensure you have the best possible input signal to noise ratio (basically you want lots of signal and no noise).

The diagram below shows the two extremes you should aim to avoid:

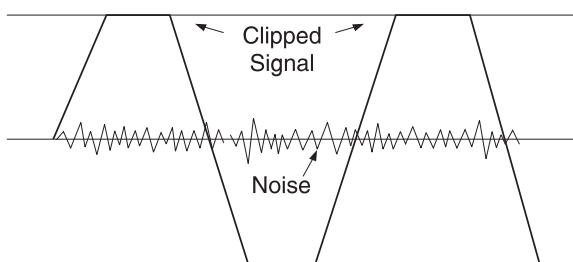

If the signal level is too high, clipping distortion may occur.

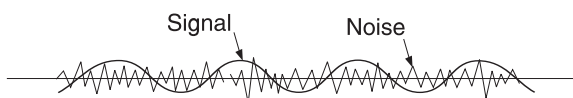

If the signal level is too low it may be masked by the noise.

## OPERATIONAL NOTES

### RECORDING A TRACK AGAINST EXISTING MATERIAL

If using a metronome, to hear the click, activate the metronome in your sequencer / hard disc recorder.

Ensure the soundcard outputs are connected to the Compact4 or Compact10 mixer inputs (Balanced, or unbalanced are available for use with cost-effective soundcards and also professional grade soundcards). It is advisable whilst doing this that you check your system is “pan-correct” i.e. that left and right are never mis-wired. Sometimes left and right can be incorrectly wired twice and sound correct, but can lead to very confusing mixing.

Create a new track within your sequencer / hard disc recorder and ensure the inputs to the track are coming from your soundcard inputs.

Press REC on the channel you want to record on the “CompACT” mixer, this will prevent any other inputs being recorded, by sending only the REC-ord channel to the main outputs of the mixer (The monitor, and engineer headphone outputs will carry this audio when the monitor button on the same channel is pressed).

The engineer headphones will always carry the same signal as the monitor outputs. The artist headphones will carry the same signal as the engineer headphones (to allow 2 people to listen to the mix on headphones), unless any/multiple REC buttons are pressed. When any/multiple REC buttons are pressed, the artist headphones will carry a mix of the REC channel and the main outputs, the % of each dependent on the position of the ARTIST MIX control. This allows the artist to hear a mix, which has a controllable level of their own voice/instrument and the mix output, rather than a level to headphones control which can be difficult to rebalance.

Rebalancing a headphone mix would result in at least three control parameters being adjusted, the REC level to headphones control, the MAIN output level control and the ARTIST HEADPHONES level control. By using the ARTIST MIX control, the artist only needs to adjust two parameters, the ARTIST MIX control and the ARTIST HEADPHONES level control.

Press the record enable on the sequencer / hard disc recorder track you are recording to, and check that you have sufficient level for recording coming from the “CompACT” mixer. You can adjust the volume with the LEVEL control on the channel and the REC-ord output level control.

If you only want to record a mono signal, then pan the mono input you are recording over to the left as far as it will go and just record the left input to your sequencer/hard-disc recorder.

Activate recording in your sequencer / hard disc recorder, and record your track.

# COMPUTER BASED RECORDING

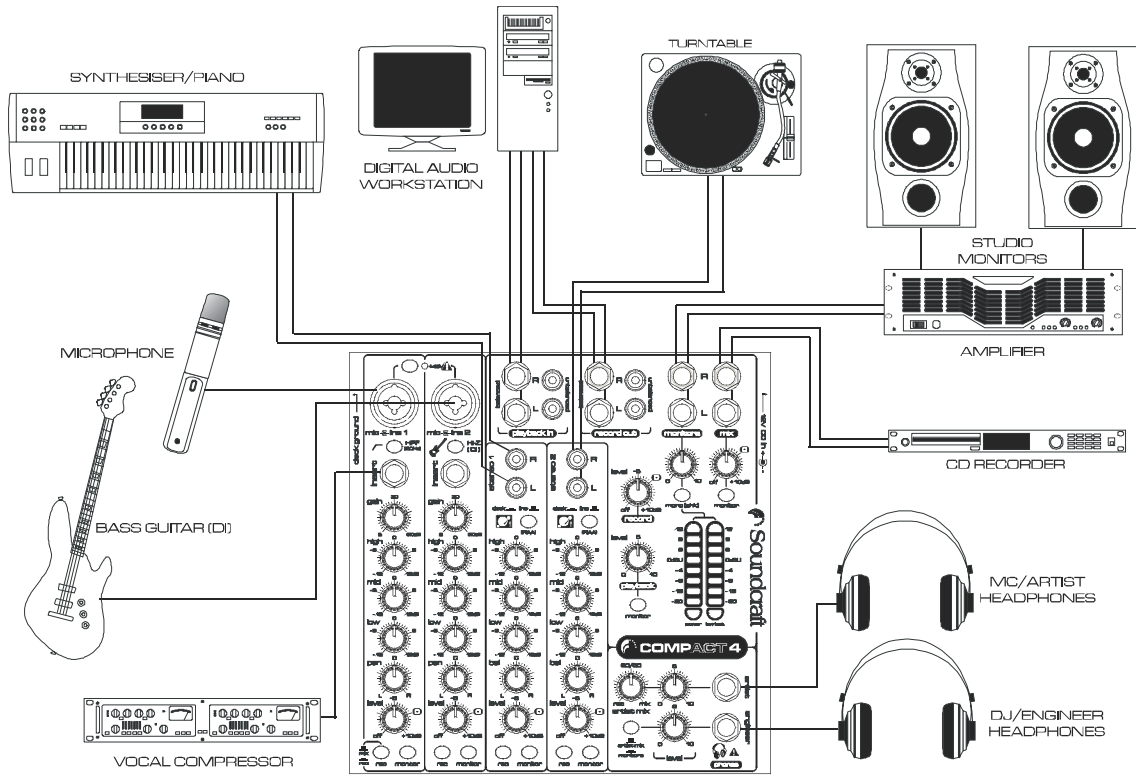

# DJ/VJ PERFORMANCE MIXING

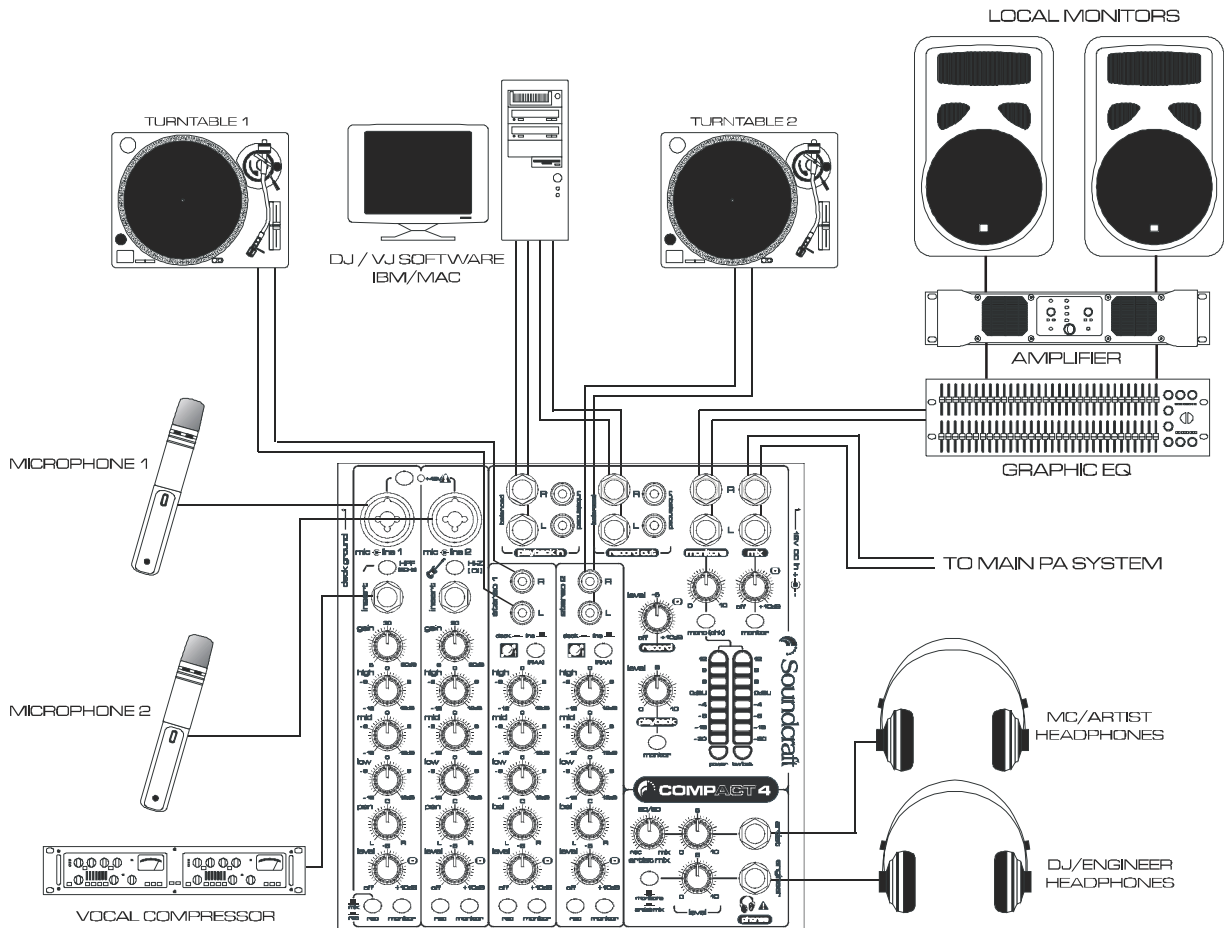



# LIVE PERFORMANCE MIXING

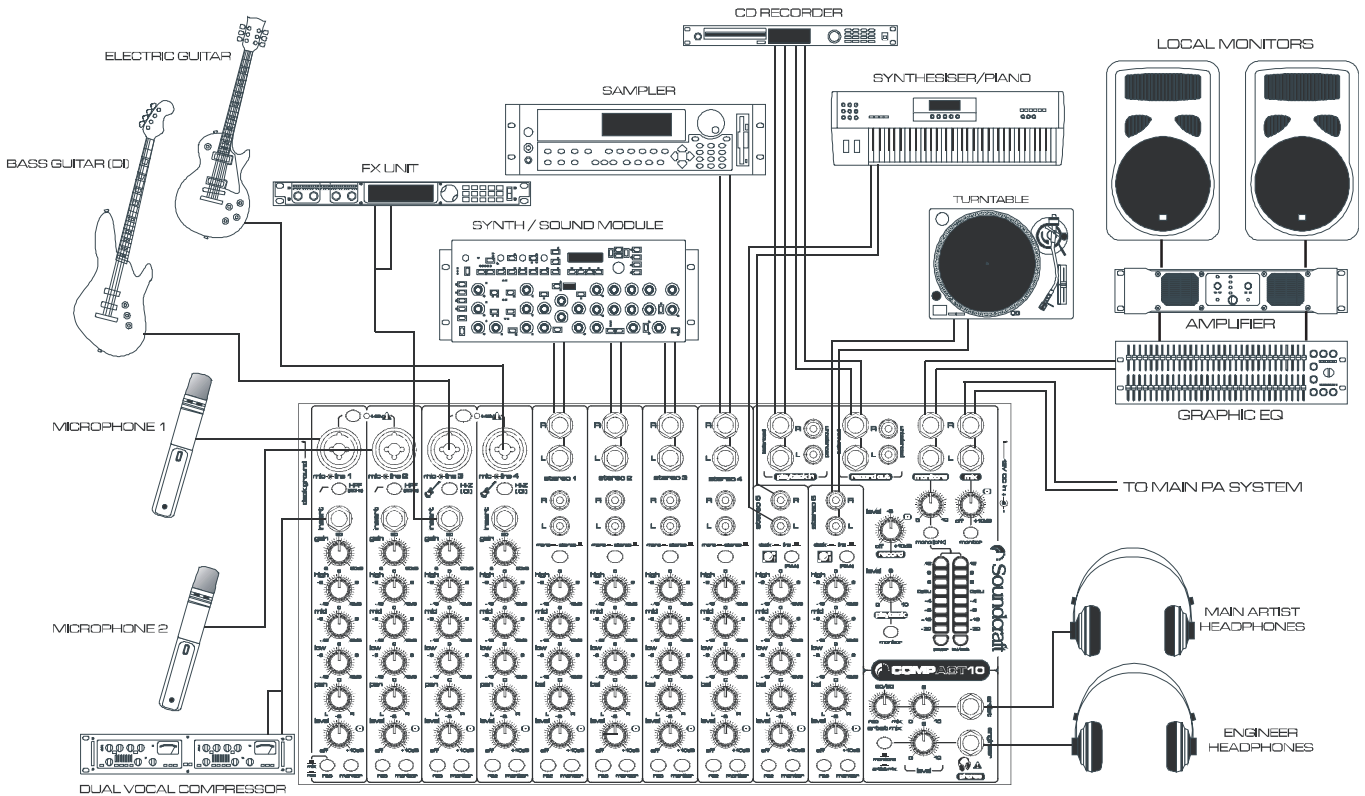

# ELECTRONIC NEWS GATHERING MIXING

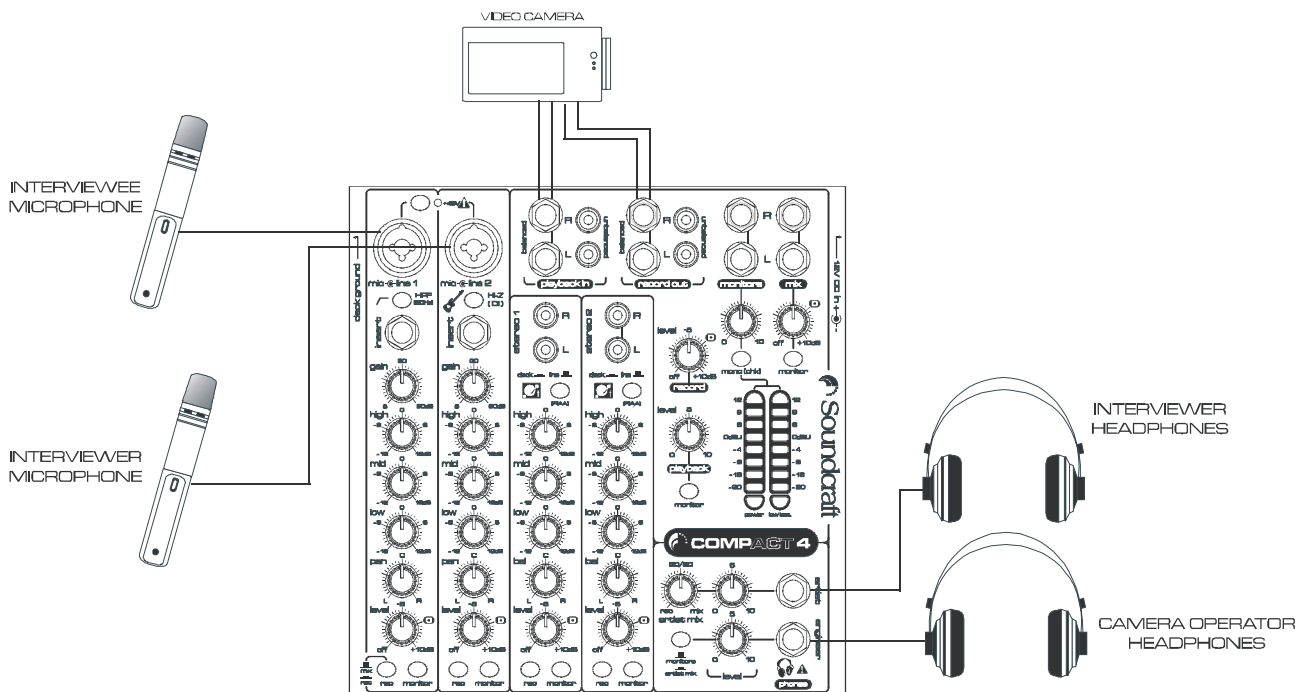

# BROADCAST STUDIO

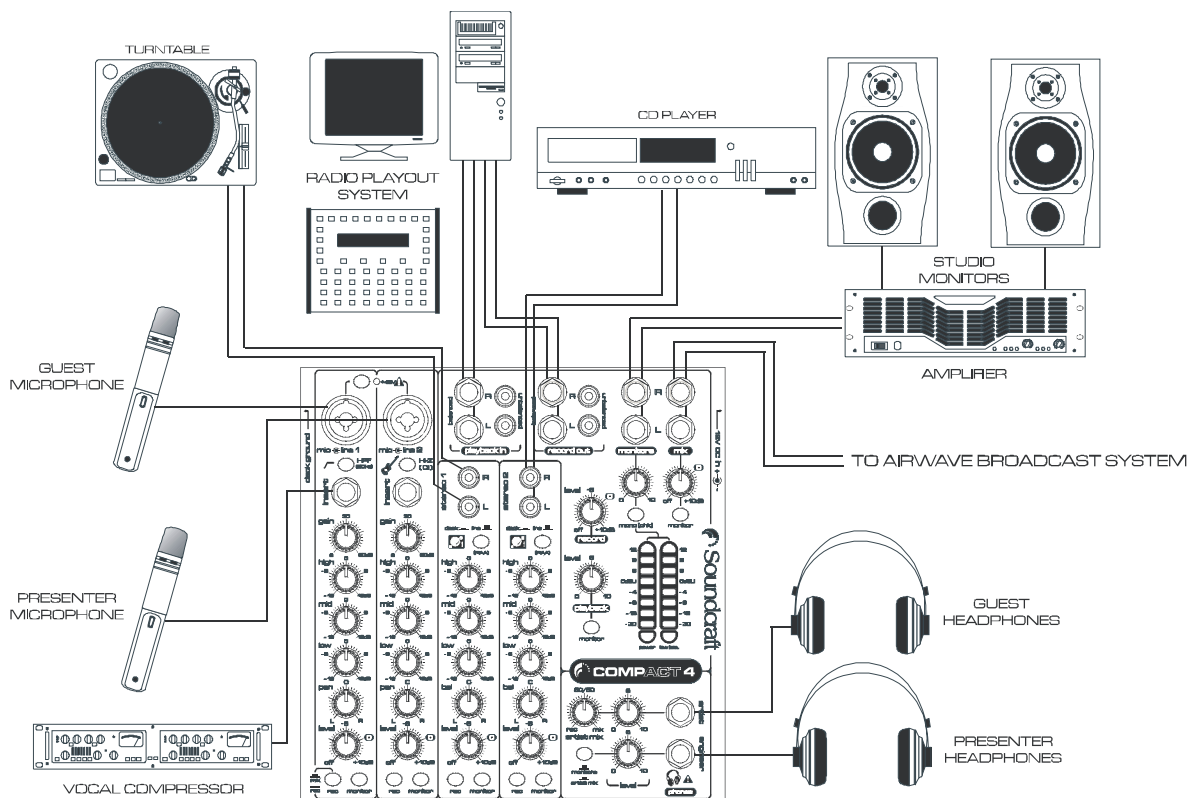

# HOUSE OF WORSHIP

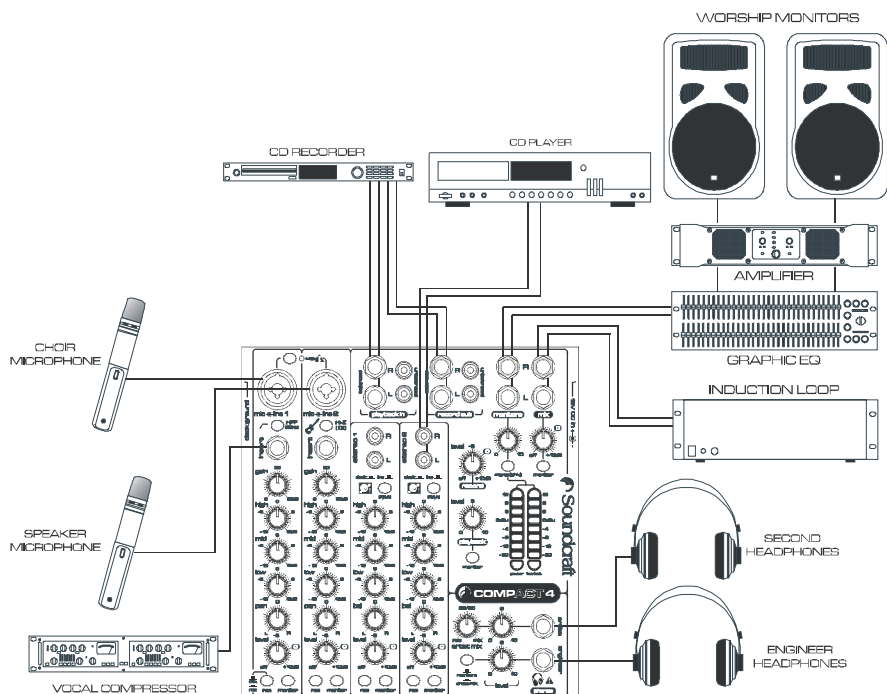

**FURTHER INFORMATION****SOUNDCRAFT WEBSITE**

Please visit <http://www.soundcraft.com/> for more information regarding operation with specific hardware.

**THE GUIDE TO MIXING**

Is a small booklet designed for entry-level users, again this can be downloaded from the Soundcraft website

## Glossary

balance	the relative levels of the left and right channels of a stereo signal.
balanced	a method of audio connection which 'balances' the wanted signal between two wires and a screen which carries no signal. Any interference is picked up equally by the two wires, which results in cancellation of the unwanted signal. In this guide, the term can refer to various circuit architectures. Connection details are given in relevant sections.
bus	a pair of stereo channels, on which signals are mixed together and travel to designated destination.
clipping	the onset of severe distortion in the signal path, usually caused by the peak signal voltage being limited by the circuit's power supply voltage.
DAT	Digital Audio Tape, a cassette-based digital recording format.
dB (decibel)	a ratio of two voltages or signal levels, expressed by the equation $dB=20\log_{10}(V1/V2)$ . Adding the suffix 'u' denotes the ratio is relative to 0.775V RMS.
DI(direct injection)/DI Box	the practice of connecting an electric musical instrument directly to the input of the mixing console, rather than to an amplifier and loudspeaker which is covered by a microphone feeding the console.
equaliser	a device that allows the boosting or cutting of selected bands of frequencies in the signal path.
fader	a linear control providing level adjustment.
feedback	the 'howling' sound caused by bringing a microphone too close to a loudspeaker driven from its amplified signal.
foldback	a feed sent back to the artistes via loudspeakers or headphones to enable them to monitor the sounds they are producing.
frequency response	the variation in gain of a device with frequency.
gain	the amount of amplification in level of the signal.
headroom	the available signal range above the nominal level before clipping occurs.
impedance balancing	a technique used on unbalanced outputs to minimise the effect of hum and interference when connecting to external balanced inputs.
insert	a break point in the signal path to allow the connection of external devices, for instance signal processors or other mixers at line level signals. Nominal levels can be anywhere between -0dBu to +6dBu, usually coming from a low impedance source.
pan (pot)	abbreviation of 'panorama': controls levels sent to left and right outputs.
peaking	the point at which a signal rises to its maximum instantaneous level, before falling back down again. It can also describe an equaliser response curve affecting only a band of frequencies, (like on a graphic equaliser), "peaking" at the centre of that band

## TYPICAL SPECIFICATIONS

### Noise (22Hz-22kHz measurement bandwidth)

Mic EIN @ max gain, 150 ohm source impedance .....	-128dBu
Mix @ unity, faders down .....	<-85dBu

### Crosstalk (typ. @ 1kHz)

Fader cut-off (rel +10 mark) .....	>80dB
------------------------------------	-------

### Frequency response

Mic/Line input to any output .....	+/- 0.5dB 20Hz - 20kHz
------------------------------------	------------------------

### THD+Noise

Mic gain 30dB	
Mix out, fader max @ 1kHz .....	<0.007 %

### Input & output Impedances

Mic input .....	2kΩ
Line input .....	>10kΩ
Hi-Z input .....	>300kΩ
Stereo input .....	47kΩ
Outputs .....	75Ω

### Input & output levels

Mic input max level .....	+16dBu
Line input max level .....	+30dBu
Stereo input max level .....	+20dBu
Mix output max level .....	+20dBu
Headphones (@ 200Ω) .....	300mW

### EQ

EQ Bands +/- 12dB	
Lo .....	60Hz
Mid .....	600Hz
Hi .....	12kHz

### Weight

COMPACT4 .....	1.75 kg (3.85lb)
COMPACT10 .....	2.75kg (6.05lb)

### AVERAGE POWER CONSUMPTION (QUIESCENT)

COMPACT4 .....	8 Watts
COMPACT10 .....	14 Watts

### MIN / MAX OPERATING TEMPERATURE (E SERIES FAMILY)

Centigrade / Farenheit .....	0°C - 50°C / 32°F - 122°F
------------------------------	---------------------------

## COMPACT4 Dimensions

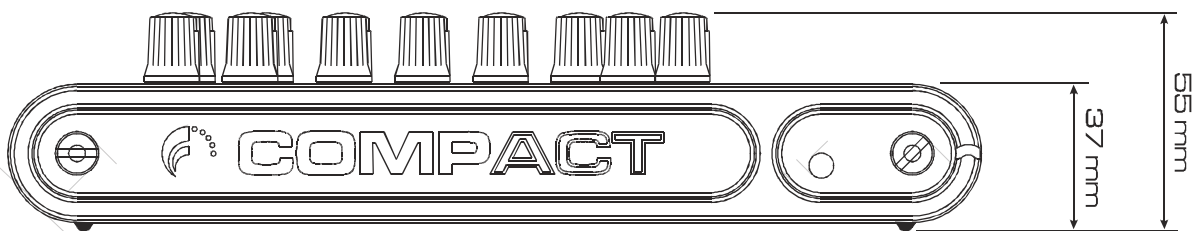
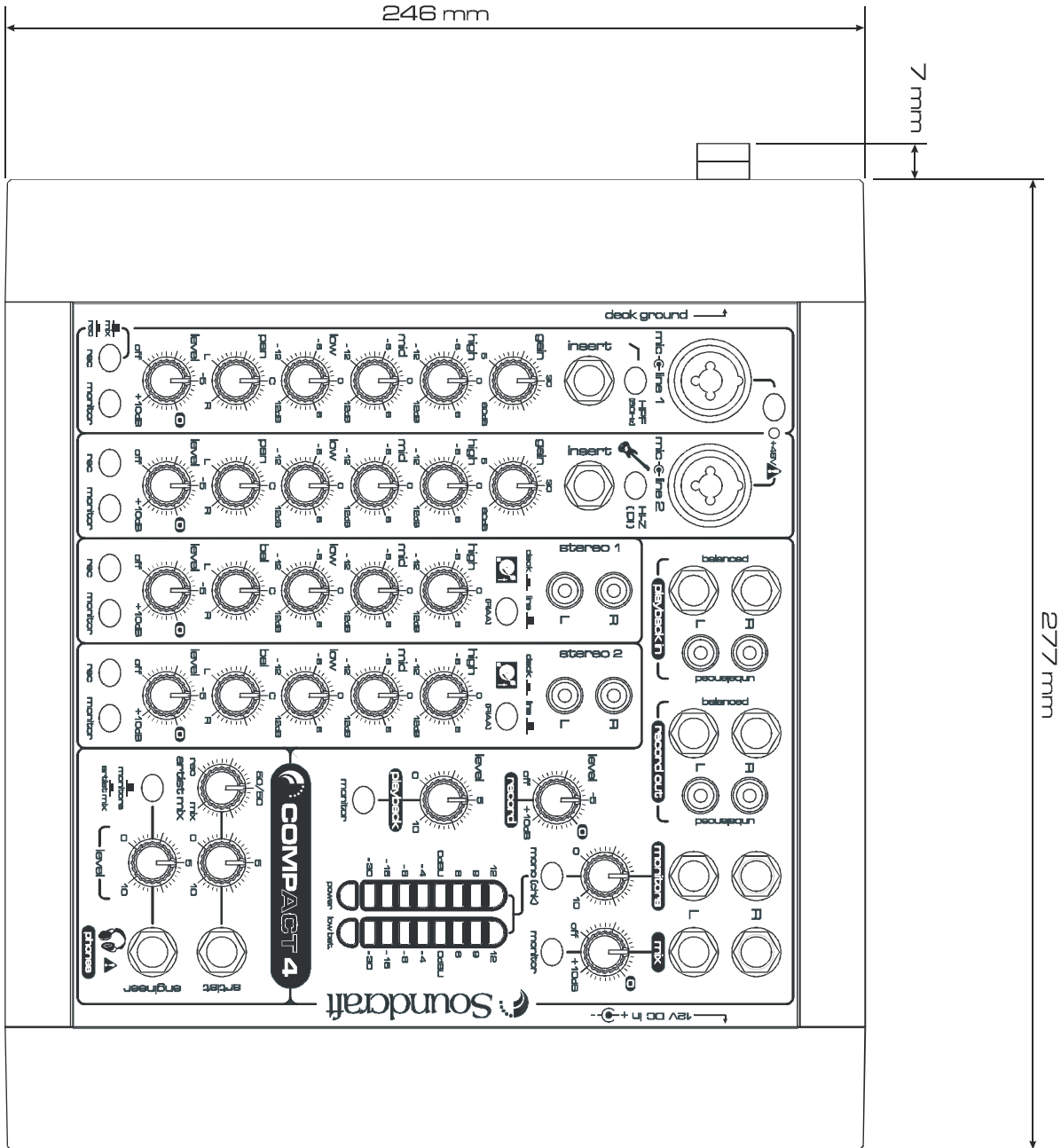

## COMPACT10 Dimensions

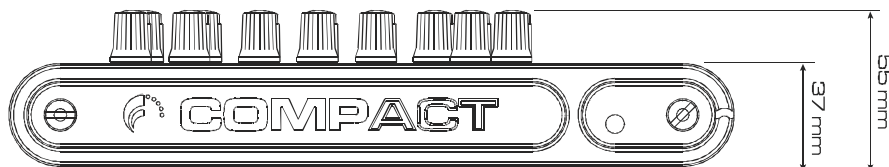
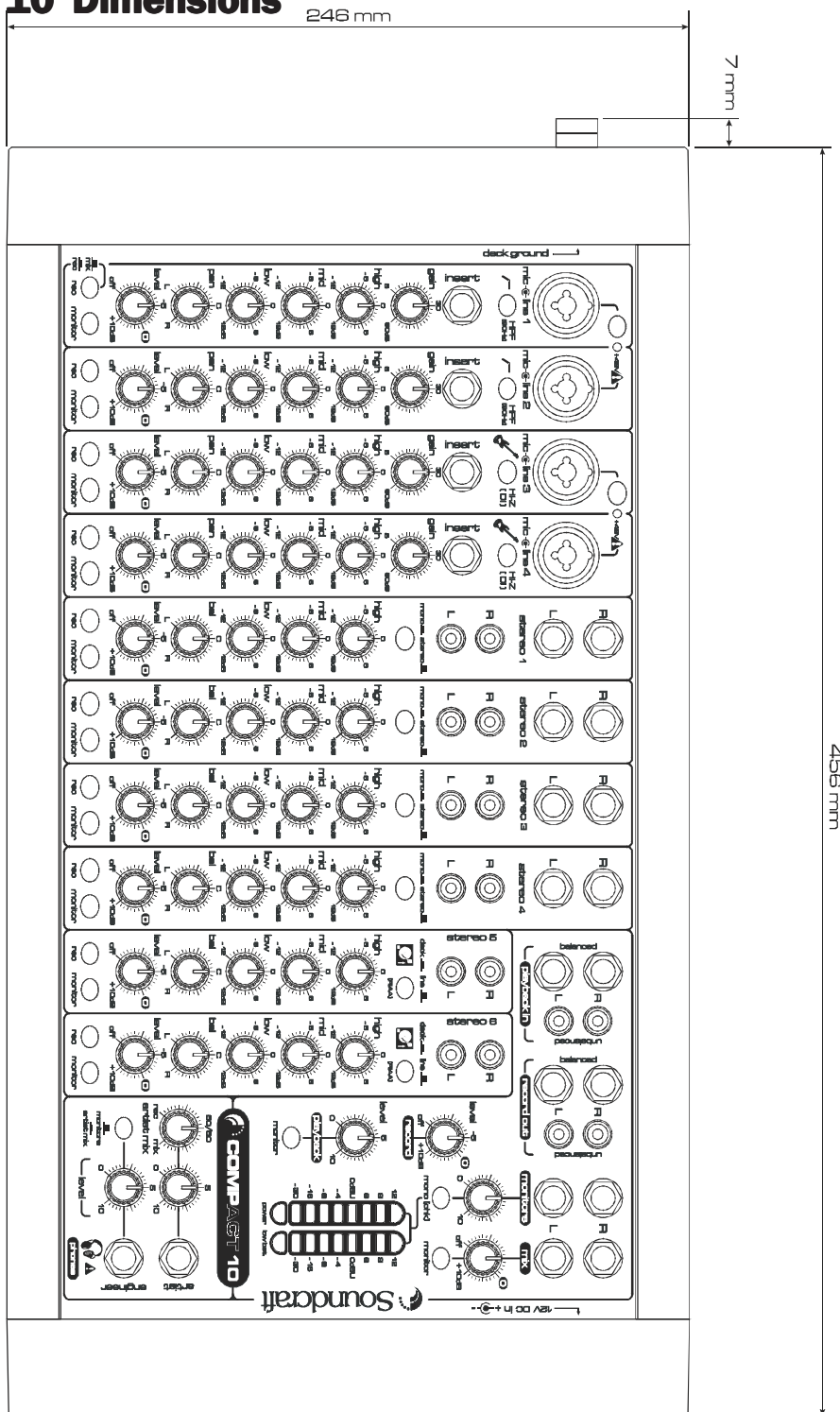

# TYPICAL CONNECTING LEADS

Audio connectors used with Soundcraft consoles

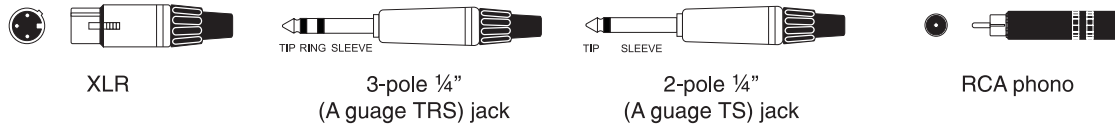

## Balanced - Line Inputs, Mix L & R Outputs, Stereo Inputs, Auxiliary Outputs

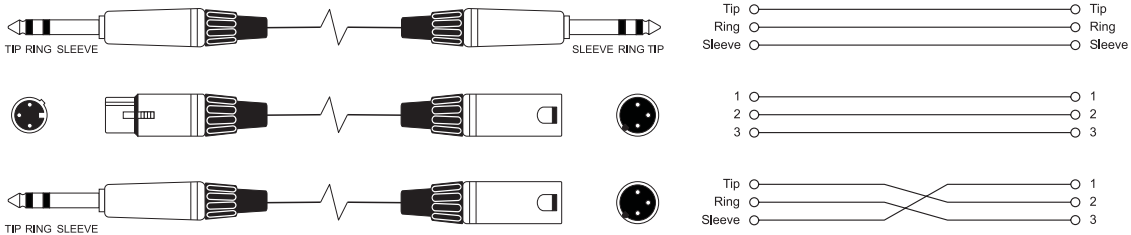

## Unbalanced - Direct Output, Monitor Output, Stereo Return Inputs

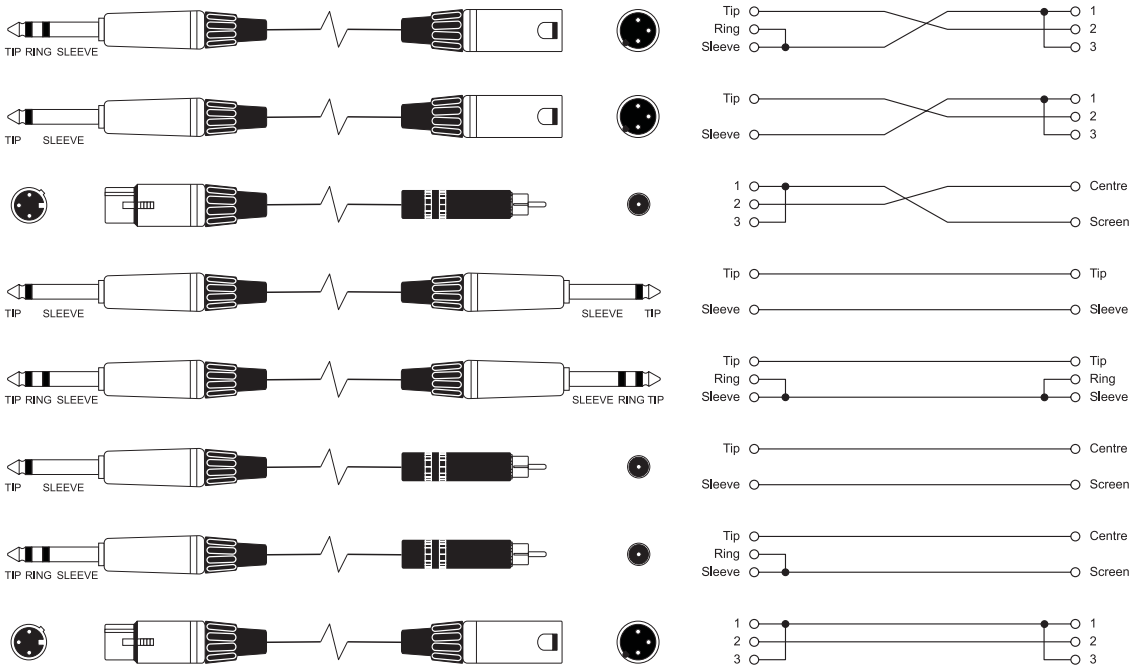

## Insert Cables - Mono Inserts

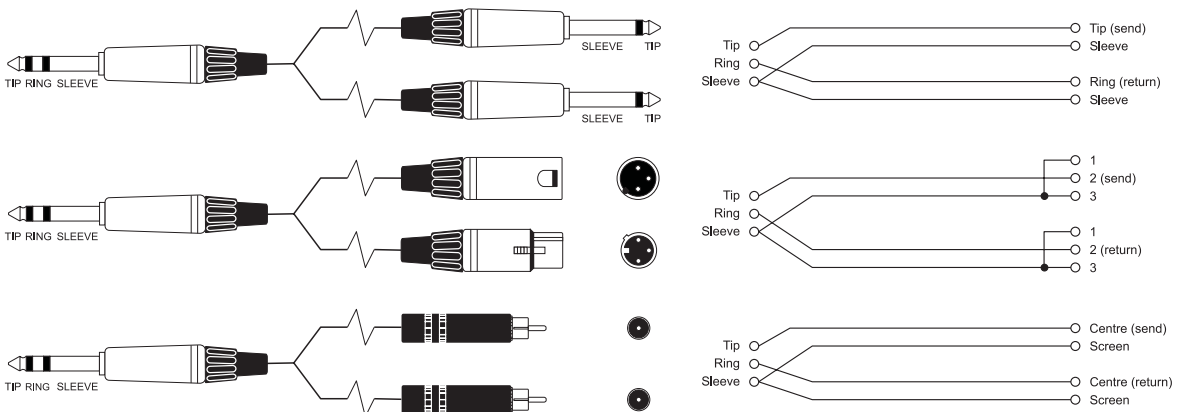



# TYPICAL CONNECTING LEADS

'Y' Cables (Balanced) Where used ... Aux, Mix outputs

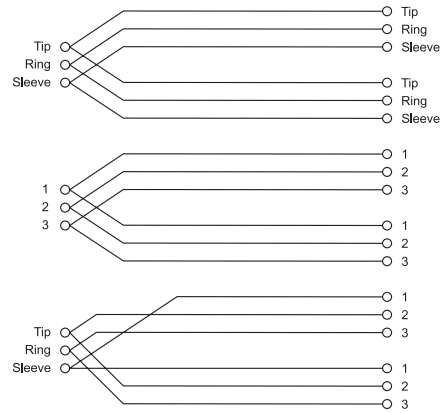
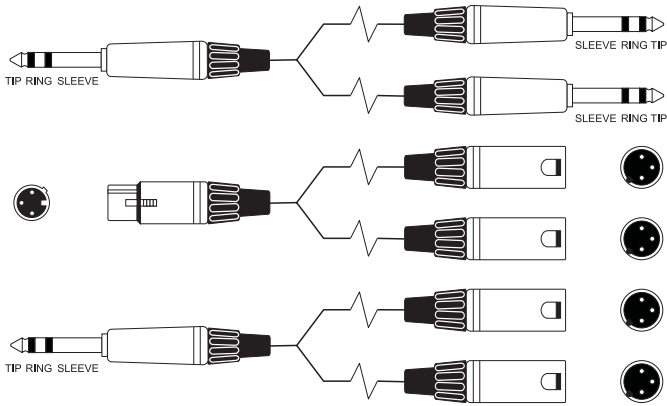

Headphone Separator Note: for every doubling of headphones the load impedance is halved. Do not go below 200R.

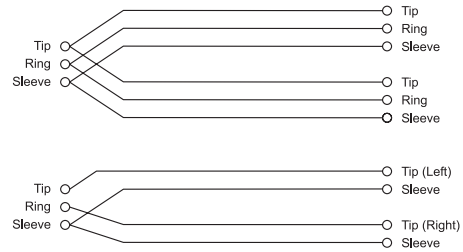
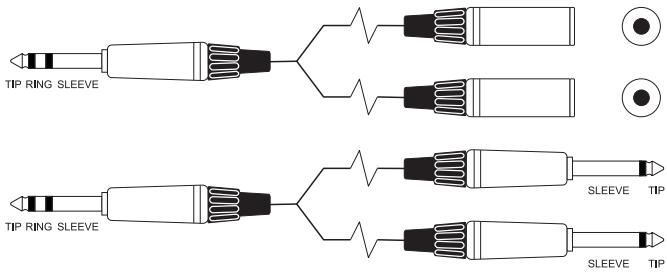

'Y' Cables (Unbalanced)

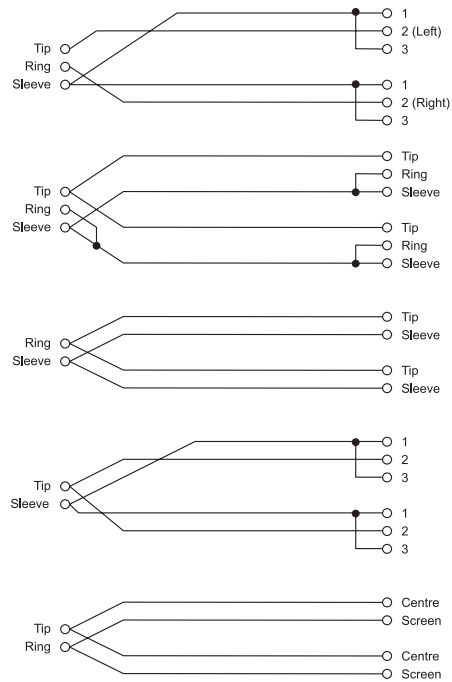
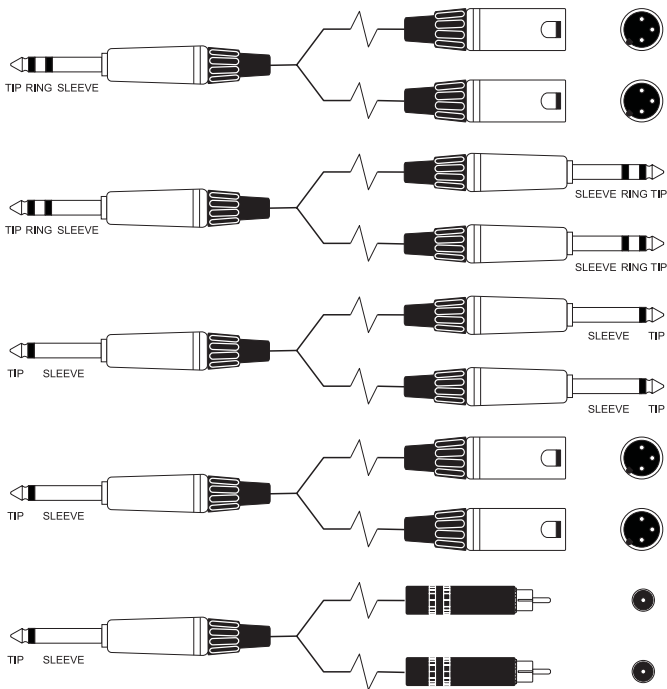

# SYSTEM BLOCK DIAGRAM

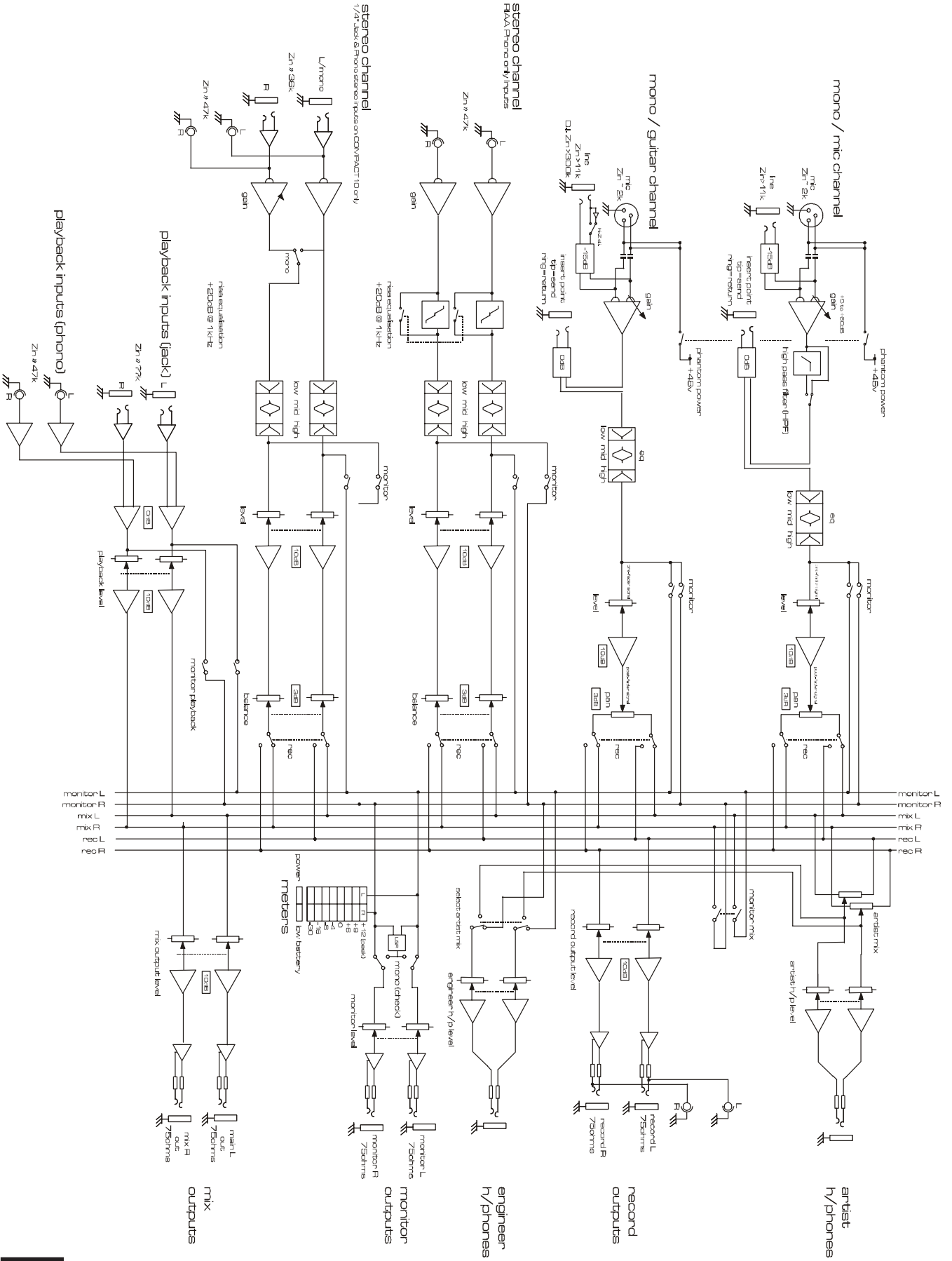

**GAIN STRUCTURE DIAGRAM**

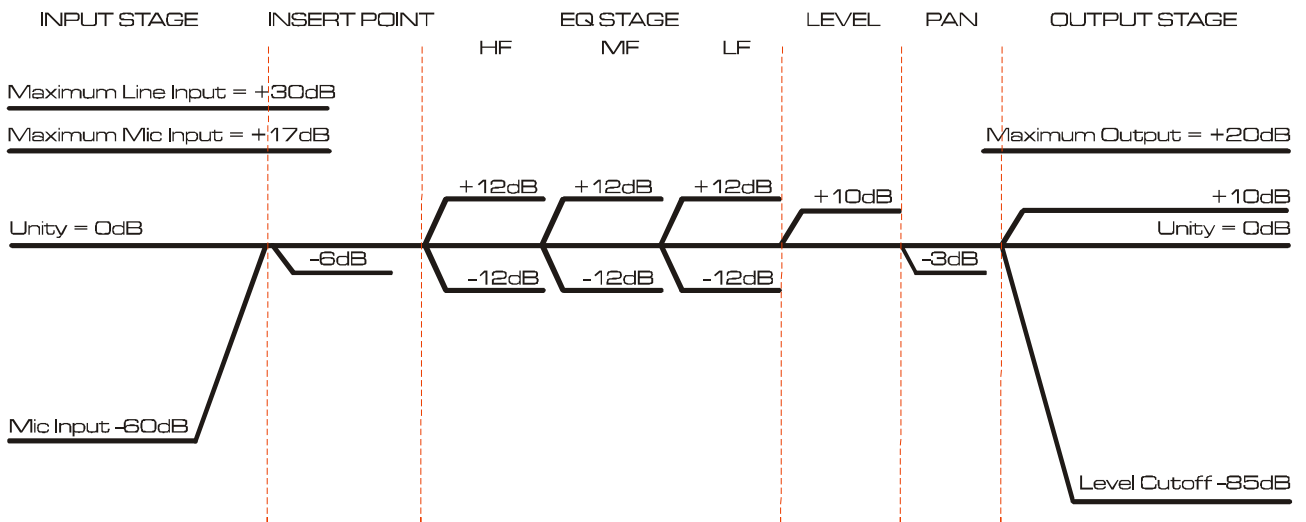

**COMPACT4 CONTROL POSITION MARK-UP SHEET**

To assist you in restoring the console to a a previous setting you may copy this sheet as many times as you like, and use the copies to make a note of your control settings.

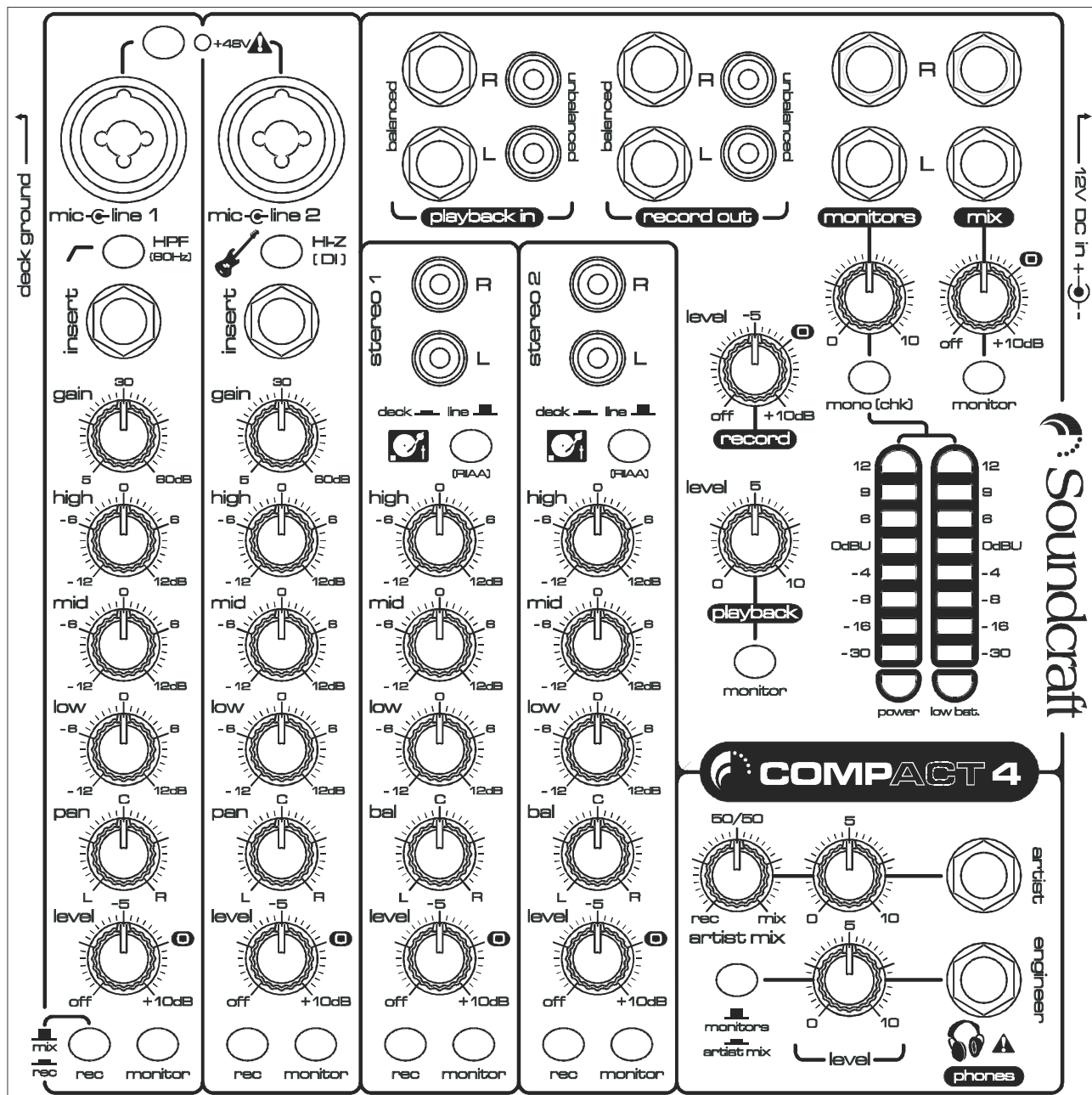

**COMPACT10 CONTROL POSITION MARK-UP SHEET**

To assist you in restoring the console to a a previous setting you may copy this sheet as many times as you like, and use the copies to make a note of your control settings.

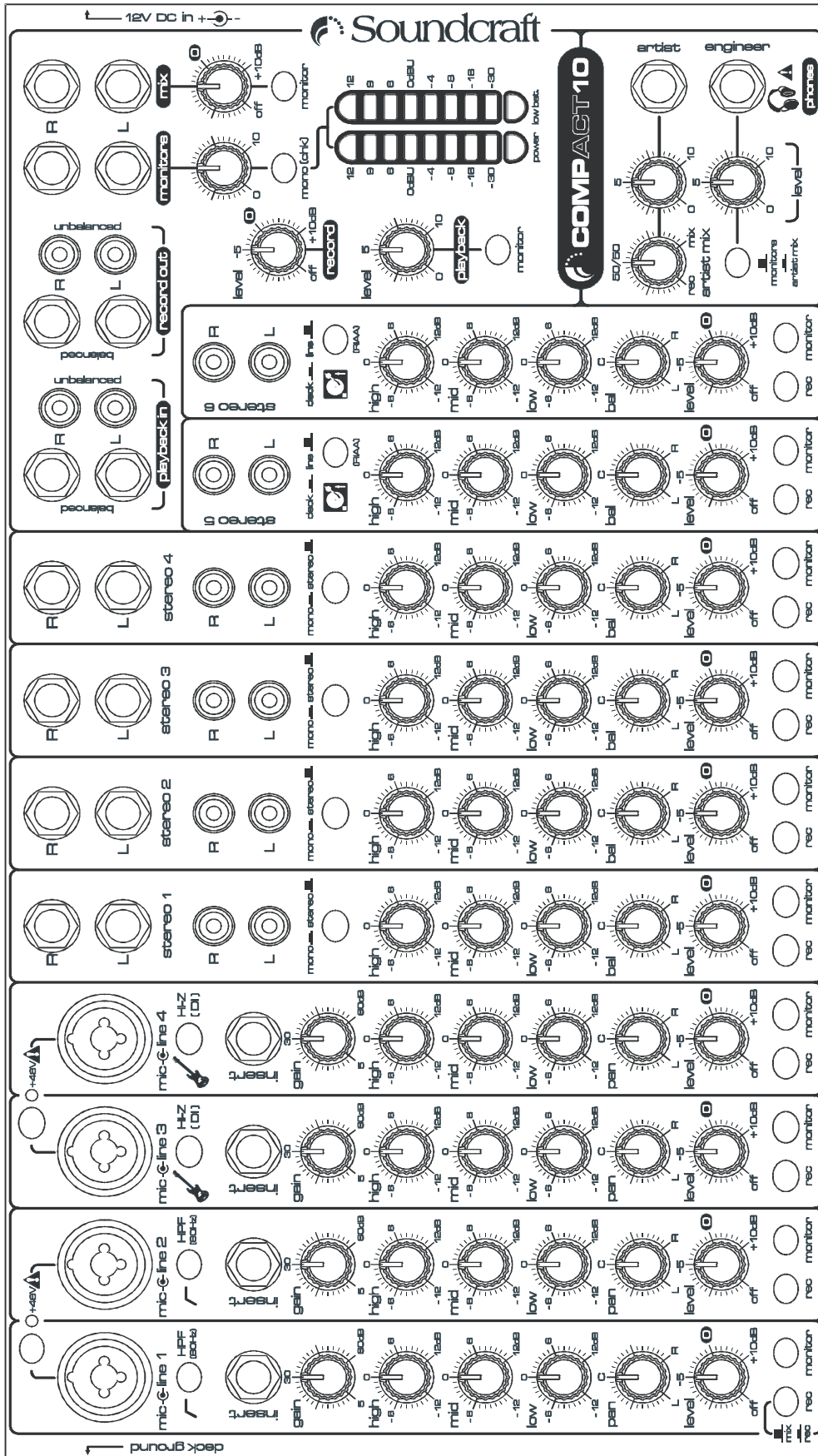

**NOTES SHEET**

Please use the following pages to make any notes specific to the operation of your console to act as reminders, or guides for other users:



**intentionally blank**