



# VENUE Profile Guide

and VENUE Software 2.9

## Legal Notices

This guide is copyrighted ©2010 by Avid Technology, Inc., (hereafter "Avid"), with all rights reserved. Under copyright laws, this guide may not be duplicated in whole or in part without the written consent of Avid.

003, 96 I/O, 96i I/O, 192 Digital I/O, 192 I/O, 888|24 I/O, 882|20 I/O, 1622 I/O, 24-Bit ADAT Bridge I/O, AudioSuite, Avid, Avid DNA, Avid Mojo, Avid Unity, Avid Unity ISIS, Avid Xpress, AVoption, Axiom, Beat Detective, Bomb Factory, Bruno, C|24, Command|8, Control|24, D-Command, D-Control, D-Fi, D-fx, D-Show, D-Verb, DAE, Digi 002, DigiBase, DigiDelivery, Intelligent Noise Reduction, TDM Bus, DigiDrive, DigiRack, DigiTest, DigiTranslator, DINR, DV Toolkit, EditPack, Eleven, HD Core, HD Process, Hybrid, Impact, Interplay, LoFi, M-Audio, MachineControl, Maxim, Mbox, MediaComposer, MIDI I/O, MIX, MultiShell, Nitris, OMF, OMF Interchange, PRE, ProControl, Pro Tools M-Powered, Pro Tools, Pro Tools|HD, Pro Tools LE, QuickPunch, Recti-Fi, Reel Tape, Reso, Reverb One, ReVibe, RTAS, Sibelius, Smack!, SoundReplacer, Sound Designer II, Strike, Structure, SYNC HD, SYNC I/O, Synchronic, TL Aggro, TL AutoPan, TL Drum Rehab, TL Everyphase, TL Fauxlder, TL In Tune, TL MasterMeter, TL Metro, TL Space, TL Utilities, Transfuser, Trillium Lane Labs, Vari-Fi Velvet, X-Form, and XMON are trademarks or registered trademarks of Avid Technology, Inc. Xpand! is Registered in the U.S. Patent and Trademark Office. All other trademarks are the property of their respective owners.

Product features, specifications, system requirements, and availability are subject to change without notice.

**Guide Part Number** 9322-62809-00 REV A 08/10

## Documentation Feedback

At Avid, we are always looking for ways to improve our documentation. If you have comments, corrections, or suggestions regarding our documentation, email us at [techpubs@avid.com](mailto:techpubs@avid.com).

# Contents

## Part I Overview and Installation

<b>Chapter 1. Introduction to VENUE Profile</b> .....	3
VENUE Profile Systems and Features .....	3
System Components .....	5
VENUE Profile Expansion Options .....	5
Operational Requirements .....	7
Connection Requirements .....	7
System Requirements and Compatibility .....	8
Registration .....	8
Conventions Used in This Guide .....	8
About <a href="http://www.avid.com">www.avid.com</a> .....	9
<b>Chapter 2. Configuring and Connecting Profile</b> .....	11
Unpacking and Assembling VENUE Profile .....	11
Assembling the Video Monitor Mount and Trackball Mount .....	11
Connections for VENUE Mix Rack Systems .....	14
Connections for VENUE Profile Systems .....	17
Profile Console Connections .....	22
Powering Up the System .....	23
Powering Down the System .....	23
Setting the System Clock .....	23
Enabling a Second Stage Rack .....	24
Digital Inputs and Sample Rate Conversion .....	24

## Part II System Description

<b>Chapter 3. VENUE Profile Control Overview</b> .....	29
VENUE Profile Top Panel .....	29
Input Channels and Faders .....	30
Assignable Channel Section .....	34
Output Masters .....	36
Master and Global Controls .....	37
Meters .....	38

<b>Chapter 4. Basic Commands and Modes</b> .....	39
Control Overview .....	39
Config Mode and Show Mode .....	40
System Lock .....	40
Global Modifier Switches .....	41
Software Screen Pages and Tabs .....	42
<b>Chapter 5. Navigating and Selecting Channels</b> .....	45
Banking Input Channels and FX Returns .....	45
Banking the Output Section .....	48
Selecting and Targeting Channels .....	48
Targeting Plug-In Inserts .....	49
Screen Controls .....	50
Screen Shortcuts .....	51
Input Channel Presets .....	54
<b>Chapter 6. Options</b> .....	57
System .....	57
Devices .....	59
Other Options and Settings .....	60

## **Part III           Signal Routing**

<b>Chapter 7. Inputs and Input Routing</b> .....	69
Configuring Inputs .....	69
Assigning Input Sources to Channels .....	70
Routing Input Channels .....	71
Using Built-In Dynamics and EQ .....	72
Using Inserts on Channels .....	73
Adjusting Input Controls .....	75
Using Input Direct .....	78
<b>Chapter 8. Outputs and Output Routing</b> .....	79
Configuring Outputs .....	79
Assigning Busses to Hardware Outputs .....	80
Routing Group Outputs to the Mains Busses .....	81
Using Inserts on Output Busses .....	82
Adjusting Output Controls .....	83
Adjusting Main Bus Controls .....	84
Direct Outputs .....	85
Matrix Mixers .....	86
Personal Q Mixers .....	86
Assigning and Using VCAs .....	86



<b>Chapter 9. Groups</b> .....	89
Configuring Group Busses .....	89
Routing Inputs to Group Busses .....	89
Routing Group Outputs to the Main Busses .....	89
Managing Group Bus Assignments .....	90
Group Bus Signal Flow Options .....	92
Adjusting Group Bus Output Controls .....	92
Simple and Expert Operational Modes .....	93
<b>Chapter 10. Aux Sends and Variable Groups</b> .....	95
Configuring Aux and Variable Group Busses .....	95
Routing Inputs to Aux Busses .....	96
Routing Aux Busses to Outputs and Plug-Ins .....	97
Adjusting Aux Send Controls .....	98
Managing Aux Bus Assignments .....	99
<b>Chapter 11. Matrix and Personal Q Mixers</b> .....	101
Matrix Mixers .....	101
Personal Q Mixers .....	102
Configuring Matrix and PQ Mixers .....	103
Adjusting Matrix and PQ Mixer Input Controls .....	106
Adjusting Matrix and PQ Mixer Output Controls .....	107
Snapshot Data and Parameters for Matrix Mixers .....	107
Working with a PQ Controller .....	108
<b>Chapter 12. Patchbay</b> .....	109
Accessing the Patchbay .....	109
Overview of the Patchbay .....	109
Navigating the Patchbay .....	111
Assigning Channels in the Patchbay .....	111
Warning when Stealing Inputs or Outputs in the Patchbay .....	113
VENUE System Information Export .....	113
Patch List Export .....	114
<b>Chapter 13. Metering</b> .....	115
Channel Meters .....	115
ACS Input and Dynamics Meters .....	116
Metering Section .....	117
Metering Options .....	118

<b>Chapter 14. Solo and Monitor Busses</b> .....	119
Solo Bus Modes .....	119
Selecting a Solo Mode .....	119
Solo Operation Options .....	120
Solo Bus Operation .....	121
Solo Safing Channels .....	121
Monitor Bus Operation .....	122
Talkback, 2-Track and Oscillator Controls .....	125
Routing the Oscillator .....	128
<b>Chapter 15. Muting and Mute Groups</b> .....	129
Muting .....	129
Mute Groups .....	129
Function Switches .....	131
<b>Part IV</b> <b>Processing</b>	
<b>Chapter 16. Dynamics</b> .....	135
Built-In Compressor/Limiter .....	135
Built-In Expander/Gate .....	136
Adjusting Dynamics .....	136
Channel Modes Affecting Dynamics .....	138
Dynamics Settings and Presets .....	139
Side-Chain Keys and Filters .....	139
<b>Chapter 17. EQ</b> .....	143
Built-In EQ Parameters .....	143
Adjusting EQ .....	144
Channel Modes Affecting EQ .....	146
Graphic EQ for Outputs .....	146
EQ Settings and Presets .....	148
<b>Chapter 18. Plug-Ins</b> .....	151
Installing and Authorizing Plug-Ins .....	151
Managing Plug-Ins on the System .....	153
Overview of Working with Plug-Ins .....	155
Plug-In Racks .....	156
Assigning and Routing Plug-Ins .....	159
Adjusting Plug-Ins .....	161
Plug-In Presets and Snapshots .....	164
Plug-In DSP Usage .....	165
Plug-In Levels .....	165
Plug-In Latency and Processing Delay .....	166
<b>Chapter 19. Hardware Inserts</b> .....	167
Assigning Hardware Inserts to Channels .....	167

## Part V Shows

<b>Chapter 20. Shows and File Management</b> .....	171
Creating Shows .....	171
Loading Shows .....	172
Working with Presets .....	173
Transferring Settings, Shows and Presets .....	175
Undoing Changes Using the History Feature .....	176
<b>Chapter 21. Snapshots</b> .....	177
Snapshots Page .....	177
Snapshot Controls on the Console .....	180
Snapshots List .....	180
Creating Snapshots .....	182
Recalling Snapshots .....	183
Recall Safe and Channel Automation Safe .....	184
Managing Snapshots .....	188
Making Changes to Snapshots .....	190
Preview Mode .....	191
Undoing Snapshot Commands .....	194
Disabling Snapshots .....	194
Adding MIDI Messages to Snapshots .....	195
Adding Tempo Data to Snapshots .....	196
Pro Tools Markers and Snapshots .....	196
Adding Plug-In Data to Snapshots .....	197
Snapshot Options .....	198
Snapshot Data Types and Parameters .....	201
<b>Chapter 22. Events</b> .....	203
Introduction .....	203
The Events Window .....	204
Creating Events .....	206
Creating Triggers .....	207
Creating Actions .....	209
Testing Events .....	210
Resetting Events .....	210
Snapshots and Events .....	211
Default Settings, Templates and Examples .....	212
Tap Tempo for Plug-ins .....	213
Trigger Types .....	215
Action Types .....	216

<b>Chapter 23. Synchronization</b> .....	219
Automating Recall of Snapshots with MIDI Time Code .....	219
Remote Control of Snapshot Recall .....	221
Triggering of External Devices on Snapshot Recall .....	222
Sending MIDI Messages on Snapshot Recall .....	222
Synchronizing with Word Clock and Digital Audio Input .....	222

<b>Chapter 24. Using the Standalone Software</b> .....	223
System Requirements .....	223
Installing the Standalone Software .....	223
Simulating a VENUE Configuration .....	224
Transfer and Filing Quick Start .....	224
Exporting System Information and Patchbay Information .....	226

## **Part VI            Specifications**

<b>Chapter 25. Mechanical Specifications</b> .....	229
--	-----

<b>Chapter 26. Audio Specifications</b> .....	231
---	-----

<b>Chapter 27. Signal Flow Diagrams</b> .....	233
VENUE Profile Systems: Input Signal Flow .....	233
VENUE Profile Systems: Output Signal Flow .....	234

<b>Chapter 28. Troubleshooting</b> .....	235
Problem Solving .....	235
In Case of System Failure .....	237
Performing a Soft Reset .....	239
Hardware Monitoring Window .....	240
Resetting Hardware Components .....	240
Using the System Restore CD to Update or Restore the System .....	241

## **Part VII            Reference**

<b>Chapter 29. Control Surface Reference</b> .....	245
VENUE Profile Console .....	245
GPI (General Purpose Interface) .....	246
GPI Wiring Diagrams .....	248

<b>Chapter 30. ECx</b> .....	251
ECx Capabilities and Features .....	251
ECx Components .....	251
System Requirements .....	251
Installing ECx Host Software .....	251
Overview of ECx Setup and Configuration .....	253
Connecting a Computer Directly to VENUE .....	253
Connecting a Wireless Router or WAP to VENUE .....	253
Setting VENUE and Client IP Addresses .....	254
Establishing a Wireless Connection .....	257
Enabling Remote Operation .....	258
Disconnecting ECx .....	259
Changing the Ethernet Control Password .....	259
<b>Appendix A. Compliance Information</b> .....	261
Environmental Compliance .....	261
EMC (Electromagnetic Compliance) .....	261
Safety Compliance .....	262
<b>Index</b> .....	263



# Part I: Overview and Installation





# Chapter 1: Introduction to VENUE Profile

Welcome to VENUE Profile, part of Avid's modular VENUE live sound environment. VENUE Profile systems offer an intuitive console layout, a flexible I/O scheme, powerful digital processing, and expansion options for integrated Pro Tools recording and artist-controlled monitor mixing.

---

## VENUE Profile Systems and Features

The VENUE Profile console can be used with one Mix Rack, or with FOH Rack and Stage Rack units.



Figure 1. VENUE Profile console

### Profile Console Control Features

- 24 bankable input channel strips, each with a touch-sensitive fader, one multi-purpose assignable rotary encoder, solo, mute and select controls
- Built-In High-Pass Filter, Dynamics and EQ processors on each input channel strip
- Level meters on each input channel strip
- Assignable Channel section with dedicated Bus Assign, Aux Send, Direct Output, EQ and Dynamics controls.
- 8 multi-purpose Output faders strips, each with a touch-sensitive fader, one multi-purpose encoder, solo, mute and select controls
- 1 Mains fader
- Up to 24 31-band Graphic EQs available for Outputs
- Main Busses configurable as Left–Center–Right or Left–Right+Mono

### Console I/O

- Talkback mic input, with gain and phantom power
- Headphone output
- USB inputs for keyboard, mouse/trackball, iLok USB Smart Keys, and USB storage devices
- VGA monitor output for software screen display
- GPI ports (DB-25) providing 8 GPI inputs and 8 GPI outputs

## VENUE Mix Rack System

VENUE Profile Console with Mix Rack



### Mix Rack Features

The Mix Rack provides all stage and mix position I/O for VENUE Mix Rack systems.

#### Stage I/O

- 48 inputs with mic preamps. Each fully recallable input provides phantom power and input gain.
- 16 line level analog outputs (expandable up to 32) to connect to mains and monitors.

#### FOH I/O

- 8 pairs of analog I/O for hardware inserts, or for input and output of line-level material from the mix position.
- Analog and digital (AES or S/PDIF) 2-Track inputs and outputs.
- Com mic input, with gain control and phantom power.
- Monitor outputs for mix position near field monitors.

#### Synchronization and Control I/O

- MIDI In and Out ports, providing 16 channels of MIDI input and 16 channels of MIDI output.
- Word clock I/O for digital clock synchronization.
- USB 2.0 ports for USB disks, iLoks, and other USB devices.
- 100 BaseT Ethernet (ECx) port for remote control.

#### CPU, DSP, and System Drives

Mix Rack houses the CPU, DSP, hard drive and CD-ROM drive that run the VENUE software on your VENUE system. System software is installed at the factory. The CD-ROM drive lets you update or restore your system software, and install compatible plug-ins from their installer discs. A standard Mix Rack includes two Mix Engine cards providing DSP for plug-ins. You can add one additional Mix Engine card, for a maximum of three.

#### Redundant Power Supply Units (PSUs)

Each Mix Rack comes with two universal (100V to 240V nominal, 50–60 Hz) PSUs with auto redundant failover and LED status indication.

## VENUE Profile System

VENUE Profile Console with FOH Rack and Stage Rack



### FOH Rack Features

The FOH Rack is used with one or more Stage Racks, and provides mix position I/O for VENUE Profile systems.

#### Audio I/O

- 8 pairs of analog I/O for hardware inserts, or for input and output of line-level material from the mix position.
- Analog and digital (AES or S/PDIF) 2-Track inputs and outputs.
- Monitor outputs for mix position near field monitors.
- Intercom mic input

#### Synchronization and Control I/O

- MIDI In and Out ports, providing 16 channels of MIDI input and 16 channels of MIDI output.
- Word clock I/O for digital clock synchronization.
- USB 2.0 ports for USB disks, iLoks, and other USB devices.
- 100 BaseT Ethernet (ECx) port for Ethernet-based remote control.
- Snake connectors to enable primary and redundant (if applicable) connection to the VENUE Stage Rack.

#### CPU, DSP, and System Drives

FOH Rack houses the CPU, DSP, hard drive and CD-ROM drive that run the VENUE software on your VENUE system. System software is installed at the factory. The CD-ROM drive lets you update or restore your system software, and install compatible plug-ins from their installer discs. A standard FOH Rack includes three Mix Engine cards, which provide DSP for plug-ins and mixing. You can add up to two additional Mix Engine cards, up to a maximum of five.

#### Redundant Power Supply Units (PSUs)

Each FOH Rack comes with two universal (100V to 240V nominal, 50–60 Hz) PSUs with auto redundant failover and LED status indication.

## Stage Rack Features

Stage Racks are used with an FOH Rack, and provide all stage audio I/O for VENUE Profile systems. Up to two Stage Racks can be used simultaneously, supporting up to 96 total inputs.

### Audio I/O

- 48 inputs with remotely controllable mic preamps and individually selectable phantom power.
- 8 analog output channels; expandable up to 48 analog or digital outputs per Stage Rack.

### Synchronization and Control I/O

- Snake connectors to enable primary and redundant (if applicable) connection to a VENUE FOH Rack.

---

## System Components

### Included Components

All VENUE Profile systems include the following:

- VENUE Profile console
- Two (2) IEC power cables
- Monitor mount for VGA screen (screen not included)
- Trackball mount (trackball not included)
- VENUE Mouse Pad
- VENUE Profile Guide
- Two (2) console lights
- Protective Dust Cover
- Rack(s) (see next)

### Racks, Software CDs, iLoks, and Cables

Each Mix Rack or FOH Rack includes:

- System Restore CD
- ECx Ethernet Control Software Installer CD
- Standalone Software Installer CD
- iLok USB Smart Key (for storing plug-in authorizations)
- Plug-in installer discs (if any) with pre-authorized iLok
- Two (2) IEC power cables
- One FOH Link cable for connection to a VENUE console

Each Stage Rack includes:

- Two (2) IEC power cables

## Additional Required Components

The following components must be purchased separately:

- Video Display (15-inch or greater flat-panel VGA display recommended; 1024x768 minimum resolution). VGA and DVI supported.
- USB keyboard and trackball/mouse (Windows compatible)

### Digital Snake Cable (VENUE Profile Systems Only)

- The connection between FOH Rack and Stage Rack requires a Digital Snake cable. This cable can be purchased directly from Avid or assembled by your preferred vendor.

## Optional Components

The following components are optional, and must be purchased separately:

- USB flash disk (or other portable USB storage device for transfer of Show data; 512 MB or larger recommended)
- Near-field monitor speakers for mix position monitoring
- Headphones with 1/4-inch jack
- Dynamic or condenser microphone and XLR mic cable (for Talkback)
- Footswitches (up to 2)
- MIDI cables (for connecting external MIDI devices)
- BNC cables (for connecting Word clock between the VENUE system and external digital devices)
- 25-pin D-Sub cables (for connecting to GPI devices)

---

## VENUE Profile Expansion Options

The following options can be added to VENUE Profile systems. For details on all VENUE systems and options, visit the Avid website ([www.avid.com](http://www.avid.com)).

### Mix Rack Options

#### I/O Options

**AI16** Analog Mic/Line Input Card that provides 16 analog mic/line level inputs

**A016** Analog Output Card that provides 16 analog line level outputs

**X016** Analog and Digital Output Card that provides 8 analog line level outputs, and 8 AES digital outputs.

**AT16** A-Net Output Card that provides 16 channels of A-Net output compatible with Aviom® Personal Mixers and other Pro16™ Series devices.

**IOx** Input and output expansion card that provides an additional 8 channels of analog I/O and 8 channels of AES/EBU digital I/O.

## DSP Expansion Options

An additional Mix Engine card can be added to the Mix Rack (up to a maximum of three Mix Engine cards) to increase the amount of DSP available for mixing and plug-in processing.

## Record and Playback Options

**FWx Firewire Card** This FireWire-based option lets you record or play back up to 18 channels of audio directly from Mix Rack with a Pro Tools LE™ system.

**HDx TDM Card** This option lets you record or play back up to 64 channels of audio directly from Mix Rack with a Pro Tools|HD® system.



*Only a single HDx Card can be installed in a Mix Rack. Only one Record and Playback Option can be installed at any one time.*

**VENUE MADI Card** This option card lets you send or receive up to 64 channels of MADI digital audio. The VENUE MADI card can be connected to any compatible MADI device, such as HD MADI audio interfaces for Pro Tools.

## FOH Rack Options

### I/O Options

An FOH Input/Output (IOx) card can be added to the FOH Rack, providing an additional 8 channels of analog I/O and 8 channels of AES/EBU Digital I/O.

### DSP Expansion Options

Additional Mix Engine cards can be added to the FOH Rack (up to a maximum of 5 Mix Engine cards) for increased mixing and plug-in processing capacity.

### Snake Card Expansion

Adding a second Snake Card to the FOH Rack lets you add a second Stage Rack to your VENUE system, giving you a total of up to 96 channels of Stage I/O.

## Record and Playback Options

**FWx Firewire Card** This FireWire-based option lets you record or play back up to 18 channels of audio with a Pro Tools LE™ system.

**HDx TDM Card** This option lets you record or play back up to 128 channels of audio directly with a Pro Tools|HD® system.

**VENUE MADI Card** This option card lets you send or receive up to 64 channels of MADI digital audio. The VENUE MADI card can be connected to any compatible MADI device, such as HD MADI audio interfaces for Pro Tools.

## Stage Rack Options

### I/O Options

Each Stage Rack supports up to 6 input cards and 6 output cards, for a total of up to 48 inputs and up to 48 outputs (analog or digital). Stage Rack I/O options include the following:

**SRI** Analog Mic/Line Input Card that provides 8 analog mic/line level inputs

**SRO** Analog Output Card that provides 8 analog line level outputs

**DSI** Digital Output Card that provides 8 digital outputs (AES or ADAT)

**DSO** Digital Output Card that provides 8 digital outputs (AES or ADAT)

**Personal Q** The Personal Q (PQ) monitoring system lets performers adjust their monitor mix being sent from VENUE using a PQ Controller unit. The Stage rack can accommodate one PQ Rack and up to 8 PQ Controllers.

**A-Net Output** ANO A-Net Output Card that provides 16 channels of A-Net output compatible with Aviom® Pro16™ Series devices for personal monitoring.

### Additional Stage Rack

A second Stage Rack can be added for a total of up to 96 inputs or up to 96 outputs. (A second Stage Rack requires an additional Snake card be installed in the FOH Rack.)

### Redundant Digital Snake

An optional redundant Digital Snake cable can be run between the FOH Rack and each Stage Rack. This redundant Snake automatically takes over communication if the primary Snake fails.



*VENUE Profile does not support console expansion via D-Show Sidecar units.*

---

## Operational Requirements

### Temperature and Ventilation

VENUE units should be operated away from heat sources and with adequate ventilation.

 *Hardware monitoring and automatic warnings are provided for temperature, power and other factors. For more information, see “Hardware Monitoring Window” on page 240.*

### Storage

VENUE Profile should be stored and transported at temperatures not lower than 0 degrees F (–18 degrees C) and not exceeding 140 degrees F (60 degrees C).

### Operation

VENUE Profile should be operated at temperatures not lower than 40 degrees F (4 degrees C) and not exceeding 104 degrees F (40 degrees C).

During operation, the front and back panels of VENUE Profile should be exposed to ambient air. Do not block the ventilation holes on any VENUE system component.

Do not operate in direct sunlight or at extreme ambient temperatures.

### Water and Moisture

VENUE units should be operated away from sources of direct moisture and should be kept clear of liquids that might spill into the units. If condensation is present on the unit, leave the unit to dry in ambient air for at least one hour before powering the unit on.

#### Humidity ranges for storage and operation

Storage humidity range	5% to 95%, non-condensing
Operating humidity range	20% to 80%, non-condensing

### Cleaning and Maintenance

Use a dry cloth to clean the VENUE Profile top surface when needed. Do not apply any cleaning solutions, spray cleaners, or abrasives to the surface.

---

## Connection Requirements

### Power Connections

Each VENUE component requires its own power connection for primary and redundant power (if applicable). Make sure your power source is correctly rated for the number of units you are connecting. A surge-protected power source (not included) is highly recommended.

VENUE Profile power supplies are capable of operating at 50 to 60 Hz across a voltage range of 100 to 240 V.

### FOH Link Connection

Connection between the VENUE Profile console and the Mix Rack or FOH Rack is made with the provided FOH Link cable. For replacement cables, contact Avid Customer Service or your VENUE dealer.

 *For more information, see the VENUE FOH Rack Guide.*

### Audio Connections

All VENUE Profile system analog audio inputs and outputs (except Headphones) are balanced XLR or balanced 1/4-inch connections.

All external digital audio inputs and outputs are AES/EBU (XLR), ADAT (Lightpipe) or S/PDIF (RCA) connections.

 *For more information on audio connectors and specifications, see Chapter 26, “Audio Specifications.”*

### Snake Connections

#### VENUE Mix Rack Systems

For Mix Rack, an analog multicore snake (not provided) is recommended to bring inputs from stage to the mix position, and return outputs back to the stage for monitor and mains amplification.

#### VENUE Profile Systems

Connection between the FOH Rack and the Stage Rack is made with the Digital Snake cable (not included). Cables can be purchased directly from Avid or assembled by your preferred vendor. For Snake cable specifications and requirements, see the *VENUE Stage Rack Guide*.

---

## System Requirements and Compatibility

Avid can only assure compatibility and provide support for hardware and software it has tested and approved.

For complete system requirements and a list of qualified computers, operating systems, hard drives, and third-party devices, visit:

[www.avid.com/compatibility](http://www.avid.com/compatibility)

---

## Registration

Review the enclosed Registration Information Card and follow the instructions on it to quickly register your purchase online. By registering, you become eligible to receive the following:

- Technical support information
- Software update and upgrade notices
- Hardware warranty information

---

## Conventions Used in This Guide

All of our guides use the following conventions to indicate menu choices and key commands:

Convention	Action
File > Save	Choose Save from the File menu
Control+N	Hold down the Control key and press the N key
Control-click	Hold down the Control key and click the mouse button
Right-click	Click with the right mouse button

The names of Commands, Options, and Settings that appear on-screen are in a different font.

The following symbols are used to highlight important information:

 *User Tips are helpful hints for getting the most from your system.*

 *Important Notices include information that could affect your data or the performance of your system.*

 *Shortcuts show you useful keyboard or mouse shortcuts.*

 *Cross References point to related sections in this guide and other VENUE guides.*

---

## About [www.avid.com](http://www.avid.com)

The Avid website ([www.avid.com](http://www.avid.com)) is your best online source for information to help you get the most out of your system. The following are just a few of the services and features available.

**Product Registration** Register your purchase online.

**Support and Downloads** Contact Customer Success (technical support); download software updates and the latest online manuals; browse the Compatibility documents for system requirements or search the online Knowledgebase.

**Training and Education** Study on your own using courses available online or find out how you can learn in a classroom setting at a certified Avid training center.

**Products and Developers** Learn about Avid products; download demo software or learn about our Development Partners and their plug-ins, applications, and hardware.

**News and Events** Get the latest news from Avid or sign up for a product demo.

**Pro Tools Accelerated Videos** Watch the series of free tutorial videos. Accelerated Videos are designed to help you get up and running with Pro Tools and its plug-ins quickly.

**Live Sound Webinars** Watch free tutorial videos and VENUE-specific webinars to learn from the experts.

To learn more about these and other resources available from Avid, visit our website ([www.avid.com](http://www.avid.com)).





# Chapter 2: Configuring and Connecting Profile

The chapter shows how to connect the components of a VENUE Mix Rack and VENUE Profile system.

## Unpacking and Assembling VENUE Profile

- ◆ Remove all components from the shipping packaging.
- ◆ Place the Profile console on a table or other stable surface that leaves full access to the front and back panel connectors and mounts.
- ◆ Make sure all components are free of any bags, padding or other materials.
- ◆ Keep cables and other included items organized, making sure to keep them with their associated component after unpacking.

## Assembling the Video Monitor Mount and Trackball Mount

Profile includes a Video Monitor Mount for your VGA monitor, and a Trackball mount for your mouse or trackball.

### Assembling the Video Monitor Mount

The Video Monitor Mount is assembled by attaching a flat panel VGA monitor to the mounting arm. Both 100mm and 75mm VESA (FDMI) video mounting standards are supported.

Assembling the Video Monitor Mount requires the following items:

- A VGA flat panel display with 100mm or 75mm mounting compatibility
- A medium sized Phillips screwdriver
- A table or similar clear, flat area with a towel or other padded surface (big enough to safely lay your video monitor face down)

### To assemble the Video Monitor Mount:

**1** Remove the Video Monitor Mount components from their packaging.

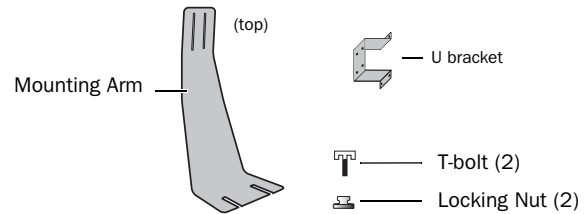

### Components of the Video Monitor Mount

**2** Make sure your video monitor is powered off and disconnected, and lay it face down on a padded table.

**3** Attach your monitor to the Video Monitor Mount by doing either of the following, as appropriate for your video monitor:

**100mm (MIS-D100)** Attach the U bracket to the included mounting plate using the provided hardware. To complete the assembly, remove the 4 mounting screws from the back of the video monitor, line up the holes of the mounting plate, and use the screws you removed to secure the plate to the back of your monitor.

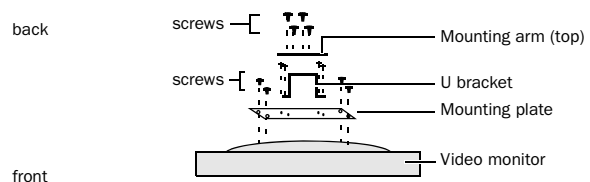

**Attaching a 100mm VGA monitor to the mounting plate, U bracket and mounting arm, viewed from the top edge of the monitor**

**75mm (MIS-D 75)** Use the included U bracket. Remove the appropriate screws from the back of your monitor and use them to secure the U bracket to the back of the monitor.

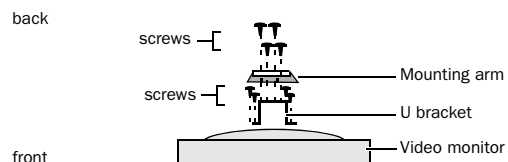

**Attaching a 75 VGA monitor to the U bracket and mounting arm, viewed from the top edge of the monitor**

4 Hold the mounting arm face down so that the narrow (top) end is against the back of the U bracket. Make sure the arm is facing the correct way, and attach the arm to the U bracket using the four screws provided. Make sure all screws are tightened securely.

### Attaching the Video Monitor Mount the First Time

#### To attach the Video Monitor Mount to the console:

- 1 From the back of the console, locate the Video Mount slot below the edge of the outermost back panel extrusion.
- 2 Take one of the T-bolts included with the Video Mount and insert it into the wider opening at the far left end of the Video Mount slot. Slide the T-bolt to the right along the slot until it stays in the track.

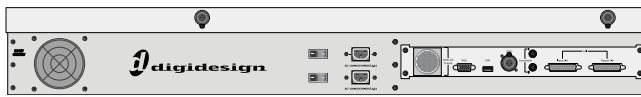

Video Mount slot

#### Location of the Video Mount slot

- 3 Take the second T-bolt, insert it into the opening at the left and slide it to be a few inches away from the first T-bolt.
- 4 Take the two silver lock nuts (thumb nuts) and thread them loosely onto the T-bolts (do not tighten them).
- 5 Pick up the assembled Video Monitor Mount and hold it at the bottom of the VGA monitor, so you can balance the unit with one hand.
- 6 Position the base of the video mount under the back panel extrusion and feed the T-bolts through the two slots on the front edge of the arm assembly. Loosen the lock nuts if necessary.
- 7 Tighten the lock nuts thumb nuts to secure the Video Monitor Mount in position.

#### To move the monitor left or right:

- Loosen the thumb nuts slightly and slide the Video Monitor Mount to the left or right, being carefully not to twist it off either of the T-bolts. (If the mount comes off the T-bolts, simply reattach it and resume). When in the desired position, tighten the lock nuts.

#### To adjust the height of the monitor:

- Loosen the screws holding the monitor or U bracket to the mounting arm, and slide it down or up to the desired height. Tighten all screws to secure the monitor in its new position.

### Using the Assembled Video Monitor Mount

#### To remove the Video Monitor Mount:

- 1 Stand at the back of the console.
- 2 Holding the VGA screen in one hand, loosen the lock nuts that secure the Video Monitor Mount to the console.
- 3 Slide the Video Monitor Mount straight back off the T-bolts.
- 4 Tighten the lock nuts to secure the T-bolts.

#### To attach the assembled Video Monitor Mount to the console:

- 1 Loosen the two lock nuts securing the T-bolts in place, along the extrusion at the back of the console.
- 2 Position the Video Monitor Mount so that its base slots line up with the T-bolts, slide the Video Monitor Mount into position, and tighten the lock nuts to secure the mount into place.

### Assembling and Attaching the Trackball Mount

The Trackball Mount provides a tray for your trackball or a mouse. It can be placed anywhere along the front of the console, and accommodates left- or right-handed operation. A small hook underneath the Trackball mount lets you hang a pair of headphones.

#### Assembling the Trackball Mount

##### To attach the Trackball Mount

- 1 Unpack the Trackball Mount and components from their packaging.
- 2 Make sure to unplug any USB or headphone connections at the front of the console.
- 3 From the front of the console, locate the slot for the Trackball mount (located below the extrusion).
- 4 Take one of the T-bolts included with the Trackball Mount and insert it into the opening at the right end of the Trackball Mount slot. Slide the T-bolt to the left along the slot until it is just to the left of the front panel USB and headphone ports.
- 5 Take the second T-bolt, insert it into the opening at the right and slide it into place a few inches away from the first T-bolt.
- 6 Take the two silver lock nuts (thumb nuts) and thread them loosely onto the T-bolts (do not tighten them).
- 7 Place the Trackball Mount in position so that you can feed the T-bolts through the two slots on the lip of the Mount.



*If mounting on the right, be sure to line up the opening in the mount with the front panel USB and Headphone ports so they remain accessible.*

- 8 Tighten the lock nuts to secure the assembled Trackball Mount to the console.

## Using the Trackball Mount

The Trackball Mount can be removed and set up quickly.

**⚠** *Always disconnect USB and headphones from the front panel before removing or attaching the Trackball Mount.*

### To remove the Trackball Mount:

- 1 Holding the Trackball Mount in one hand, loosen the lock nuts that secure it to the front of the console.
- 2 Drop the Trackball Mount off track to remove the entire assembly from the console.
- 3 Replace the lock nuts onto the T-bolts and tighten them down, to secure them in place.

### To attach the assembled Trackball Mount to the console:

- 1 Loosen the two lock nuts securing the T-bolts in place, along the extrusion at the front of the console.
- 2 Position the Trackball Mount so that its base slots line up with the T-bolts, and slide the Trackball Mount into position.
- 3 Tighten the lock nuts to secure the mount into place.

## Connections for VENUE Mix Rack Systems

This section describes system and audio connections for VENUE Mix Rack systems. (For VENUE Profile systems, see “Connections for VENUE Profile Systems” on page 17).

### To connect the Profile console to a Mix Rack:

- Connect one end of the FOH Link cable to the FOH Link port on the back panel of the Profile console. Connect the other end of the FOH Link cable to the FOH Link port on the front panel of the Mix Rack. On each end, be sure to align the notch in the connector housing with the slot in the plug, and to rotate the collar until the connector is fully latched.

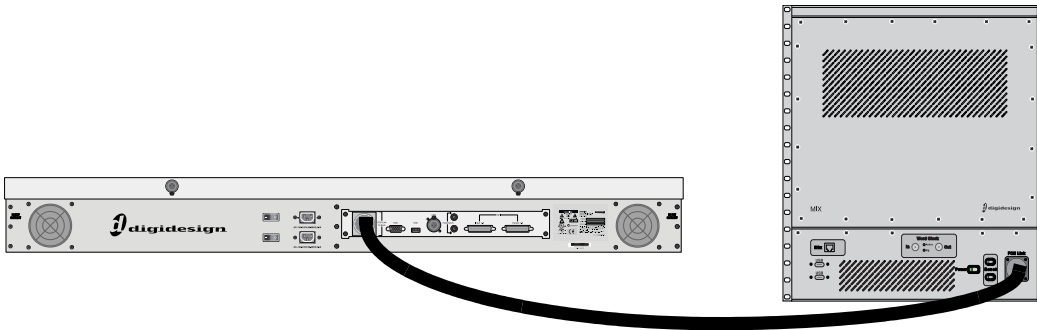

Figure 2. FOH Link connection between Profile (left) and Mix Rack (right)

## Audio Connections

Mix Rack provides 48 analog mic/line inputs, up to 32 analog line outputs, and a variety of analog and digital audio inputs and outputs. You can use an analog multicore snake cable (not included) to carry multiple stage inputs and outputs to and from the Mix Rack, or you can connect mics, instruments and other sources directly to Mix Rack Stage inputs, and connect Mix Rack Stage outputs directly to the inputs on your house/mains systems, or monitor systems.

### Stage I/O

Use the following sections to identify where to connect stage I/O to Mix Rack.

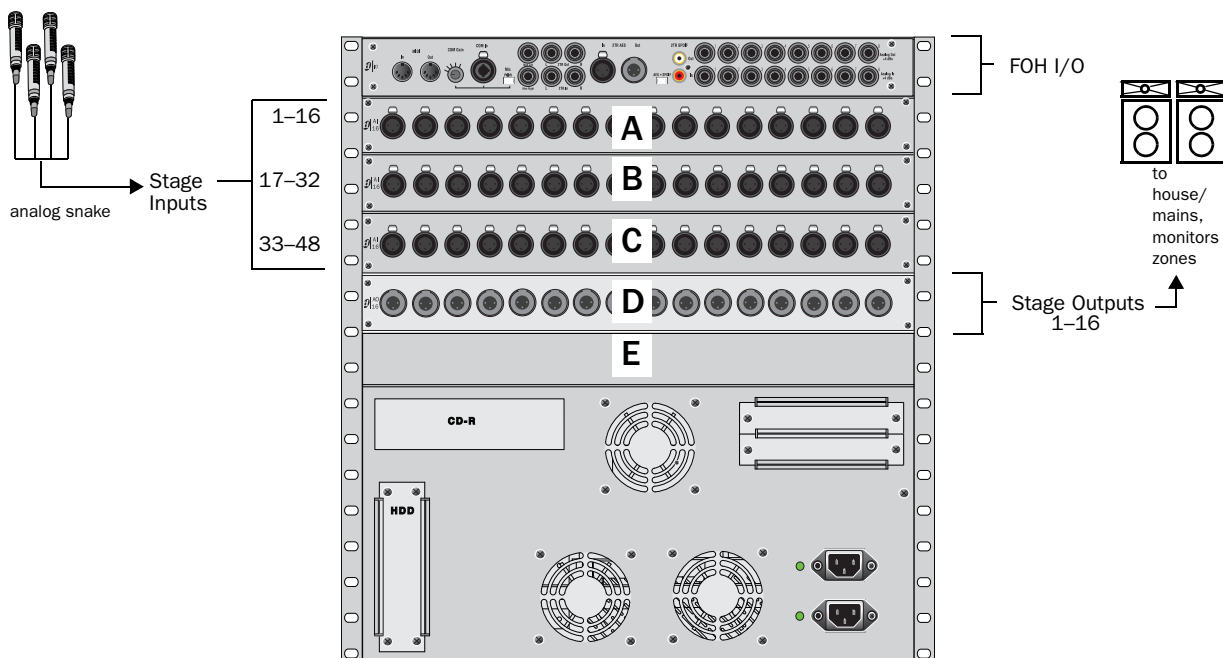

Figure 3. Mix Rack audio connectors and I/O slots (A-E) for stage inputs and outputs

## Stage Inputs 1–48

### (Analog Mic/Line XLR Inputs)

The Stage Input section provides 48 channels of analog mic/line inputs (XLR), to connect stage input sources. Use a standard analog snake cable to run lines from the stage to the Mix Rack (analog snake cable not included). Then connect the snake to Stage inputs 1–48. (For instructions on applying phantom power and other settings, see the guide that came with your console.)

## Stage Outputs 1–16

### (Analog Line XLR Outputs)

The Stage Output Section provides up to 32 channels of stage output (XLR), to connect to house/mains, monitors, additional zones, or feeds to other devices.

## FOH I/O

The following sections describe the FOH I/O section of Mix Rack, and how to use its connectors and ports for mix position audio.

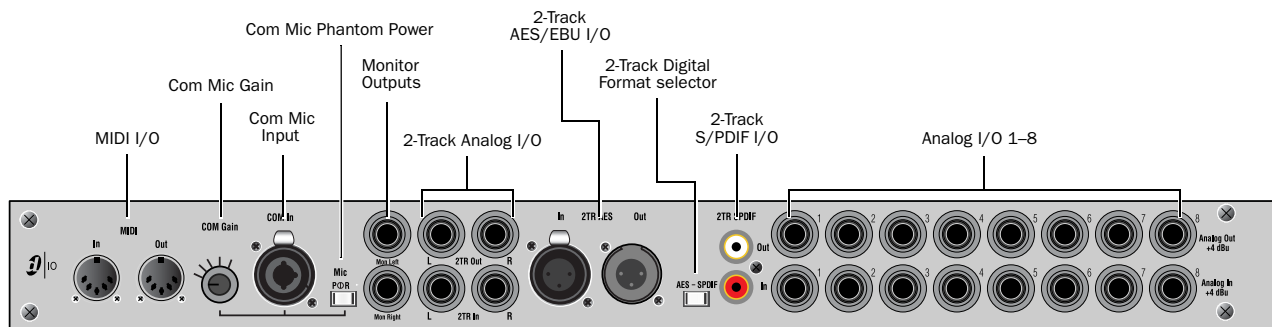

Figure 4. FOH I/O connectors on Mix Rack

### MIDI I/O Ports

The MIDI In and Out Ports provide 16 channels of MIDI input and 16 channels of MIDI output to the system. The MIDI I/O ports are used in sending and receiving Snapshot MIDI messages, and in receiving MIDI Time Code from external devices.

### Com Mic, Gain Control, and Phantom Power

The Com Mic connector and controls allow connection of a mic, or a line level source. The Com Mic input is a female XLR/TRS connector that accepts XLR or TRS jacks. The Gain control operates in steps of 3 dB. Phantom power may be applied to the Com mic with the Mic Power switch.

**⚠** Do not connect an intercom system directly to the Com input, as some intercom systems use a signalling voltage which can damage the FOH IO card.

### Monitor Outputs

The Monitor Outputs are used for output to a near-field monitors or a cue mix system (not included). These are 1/4-inch balanced TRS connectors.

### 2-Track Analog Inputs and Outputs

The 2-Track analog connections are used for input and output of analog audio material. These are balanced 1/4-inch TRS connectors.

### 2-Track Digital Inputs and Outputs

The 2-Track digital connections are used for input and output of digital audio material. Stereo AES/EBU or S/PDIF I/O connectors are selectable with the AES-SPDIF switch. These connectors support 24-bit, 48 kHz digital signals. Input signals with other sample rates are sample-rate converted to 48 kHz.

### Analog I/O (1–8)

The 8 pairs of analog line inputs and outputs are used for hardware inserts, or for input and output of program material from the mix position. These are balanced, 1/4-inch TRS connectors.

## Other Mix Rack Connections

*(AC Power, Synchronization and Optional Connections)*

### AC Power Connectors

The AC Power connectors accept standard AC power cables, for powering each of the two (redundant) internal Mix Rack power supply units. Mix Rack power supplies are auto-power selecting (100V to 240V, 50–60Hz) and automatically work with a standard modular power cord when connected to an AC receptacle in any country.

### ECx Port

The ECx port lets you connect an RJ-45 Ethernet cable for remote control of the system from a laptop or tablet computer.

 *For more information see Chapter 30, “ECx.”*

### USB Ports

The USB ports on the front panel of the Mix Rack are USB 2.0 ports, letting you connect iLoks, USB key disks and other USB devices. (An additional, secure USB port is located inside the Mix Rack chassis as well; use this internal port to connect and secure a pre-loaded iLok to always be available to that Mix Rack system.)

### FOH Link Connector

The FOH Link port connects the Profile console to the system rack (Mix Rack, or FOH Rack in conjunction with one or more Stage Racks).

### Word Clock I/O

The Word Clock In and Word Clock Out ports let you integrate external digital devices with Mix Rack.

# Connections for VENUE Profile Systems

This section describes system and audio connections for FOH Rack and Stage Rack systems. (For VENUE Mix Rack systems, see “Connections for VENUE Mix Rack Systems” on page 14).

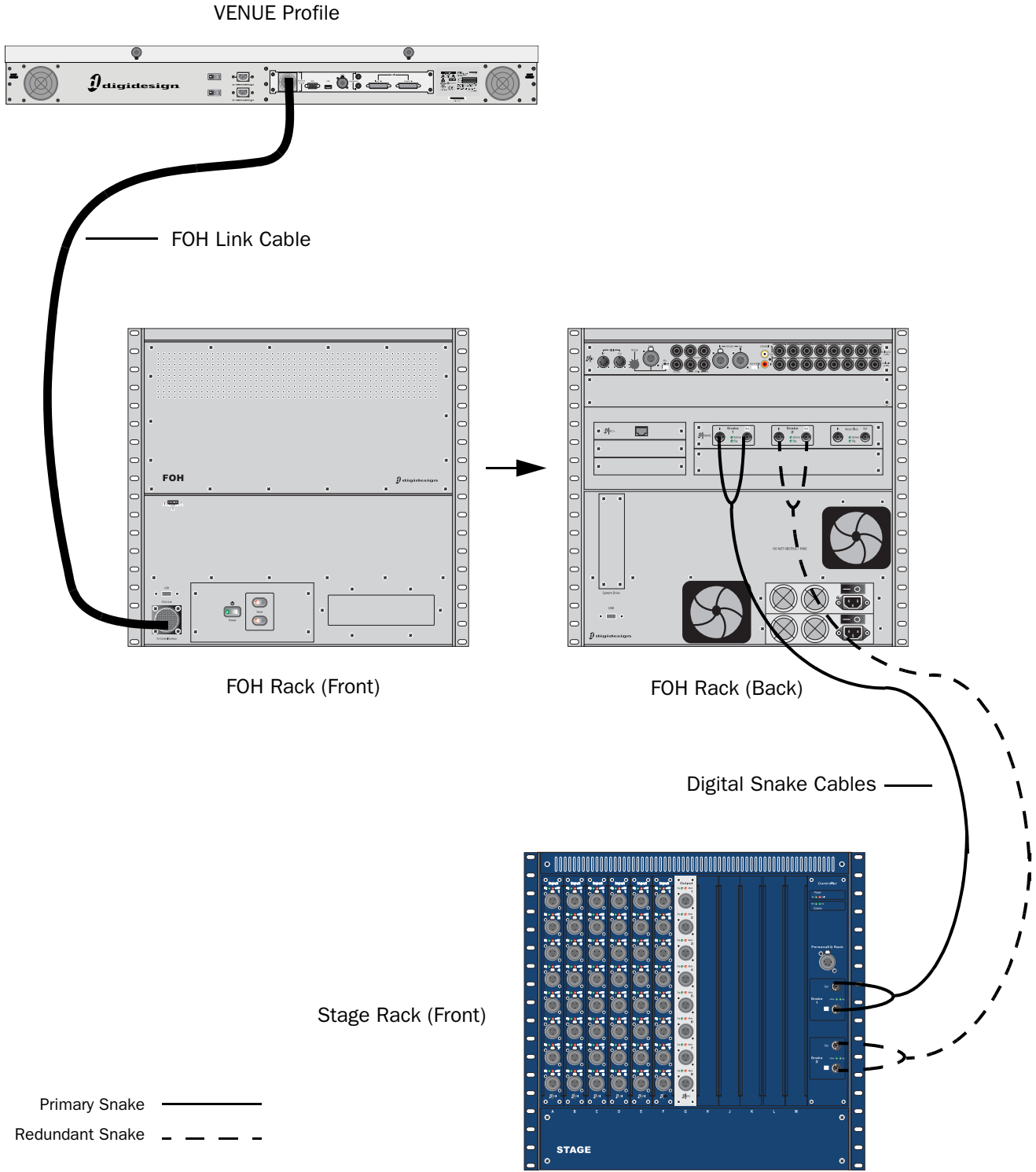

Figure 5. VENUE Profile system component connections

## Connecting Profile to the FOH Rack

The Profile console is connected to the FOH Rack with the provided FOH Link cable.

### To connect the control surface and the FOH Rack:

- Connect the FOH Link cable to the FOH Link port on the back of the Profile console, and to the FOH Link port on the front panel of the FOH Rack. On each end, be sure to align the notch in the connector housing with the slot in the plug, and to rotate the collar until the connector is fully latched.

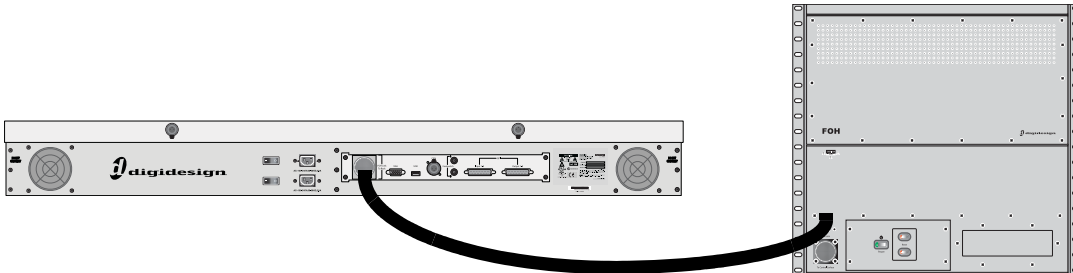

Figure 6. FOH Link connection between Profile (left) and FOH Rack (right)

## Connecting the Stage Rack to the FOH Rack

The Stage Rack is connected to the FOH Rack with the Digital Snake cable (purchased separately).

### To connect a Stage Rack to the FOH Rack:

- 1 Connect the send snake to the Stage 1 Out port of the Stage Rack, and to the Stage 1 In port on the FOH Rack.
- 2 Connect the return snake to the Stage 1 Out port on the FOH Rack, and to the Stage 1 In port on the Stage Rack.

💡 The connectors on Avid's Digital Snake cable are color coded, so that the white cable connects to the white-outlined ports.

When the system is powered up, the primary snake connection is indicated by a solid Active LED. If the Snake Signal LEDs flash, a Snake connection could not be established.

💡 If there are problems with the Snake connection, double check that all the BNC connectors are fully secured.

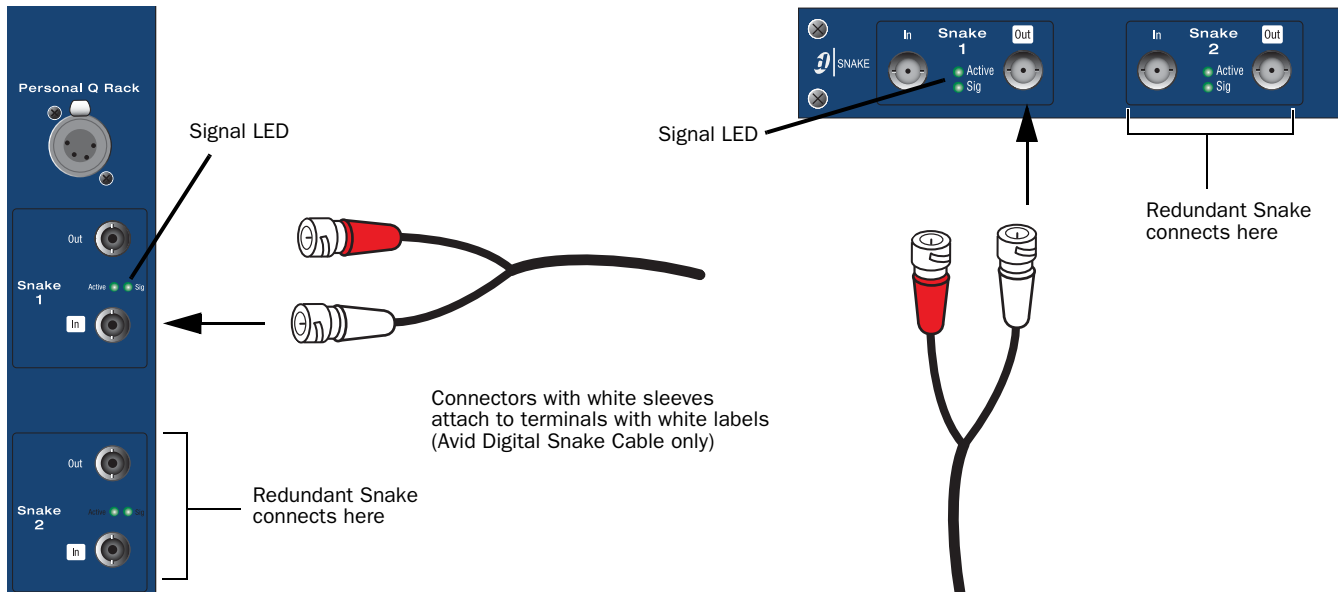



Figure 7. Detail of Digital Snake cable connection between Stage Rack (left) and FOH Rack (right)



## Connecting a Second Stage Rack

 If a second Stage Rack is used, an additional Snake Card must be installed in the FOH Rack. See the Snake Card Guide for more information.

### To connect a second Stage Rack:

1 Using a BNC cable (included with the additional Snake card), connect the Word Clock Out port on the first Snake card to the Word Clock In port on the second Snake card.

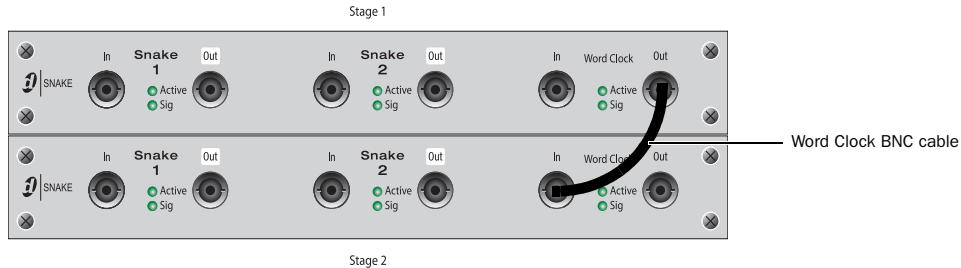

### Word Clock connection between Snake cards

2 Connect the second Stage Rack to the FOH Rack with a Digital Snake cable. See “Connecting the Stage Rack to the FOH Rack” on page 18.

 The primary and redundant snake cables must be the same length.

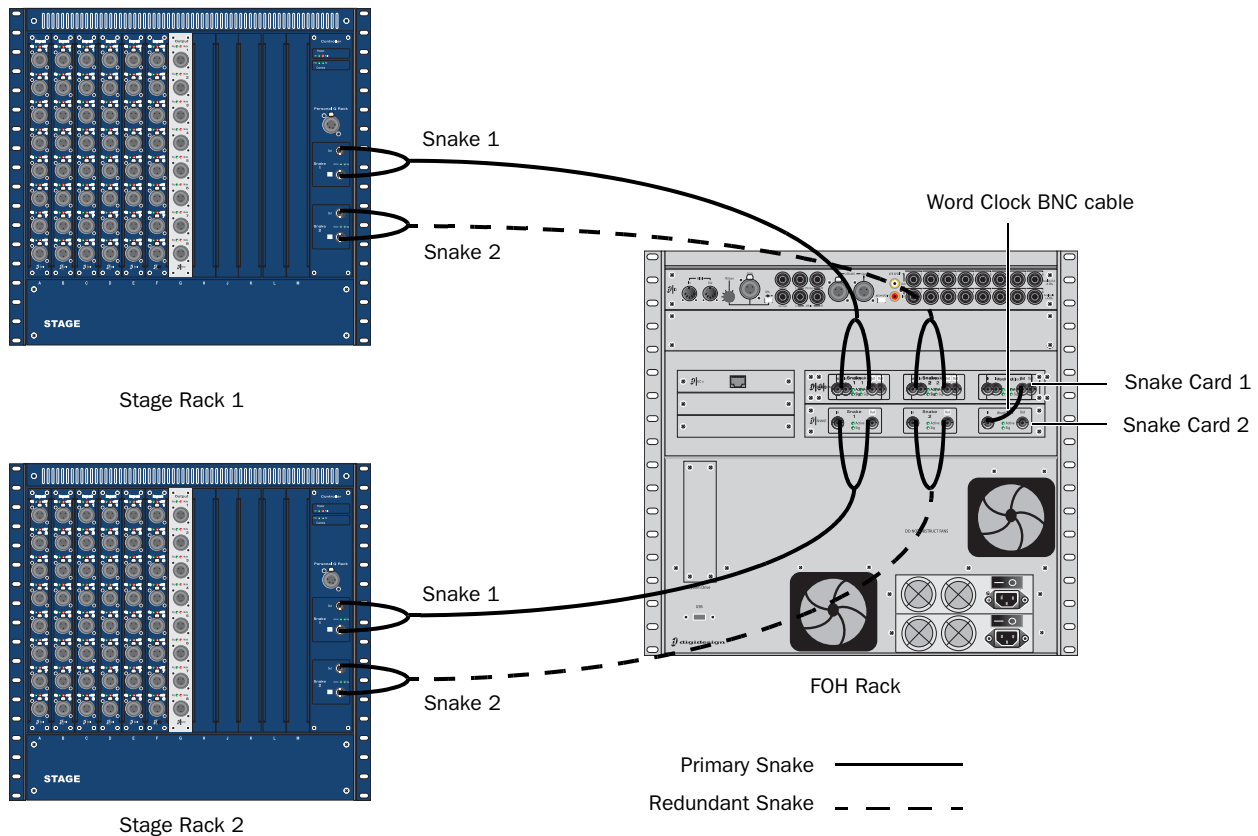

Figure 8. Digital Snake cable and word clock connections for fully redundant system with 2 Stage Racks

# Audio Connections

## Stage Rack

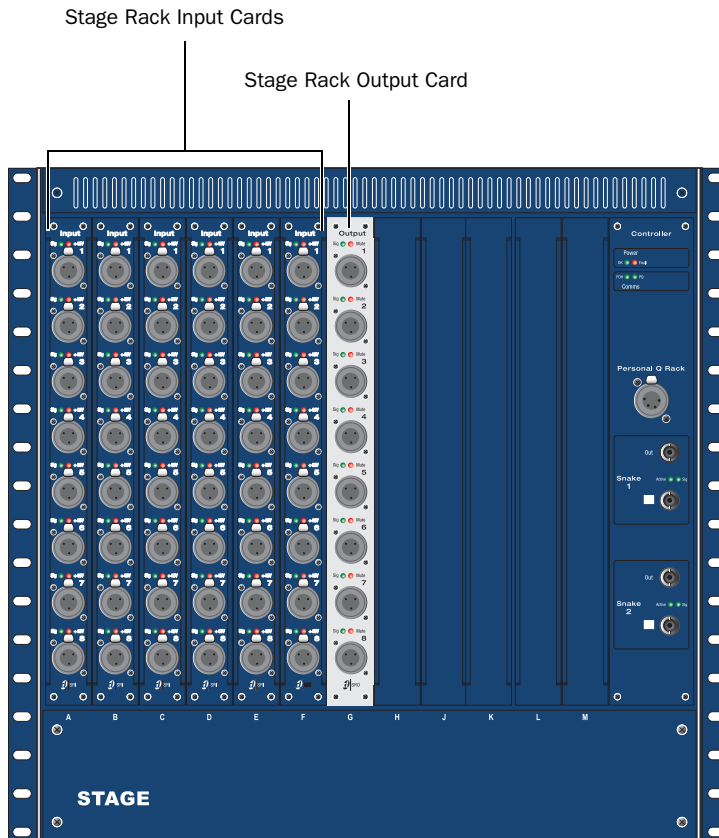

Figure 9. Audio connectors on Stage Rack

### Analog Audio Inputs

#### (Balanced Female XLR Connectors)

◆ Connect analog mic-level or line-level input sources to any of the input connectors on any SRI Card.

### Analog Audio Outputs

#### (Balanced Male XLR Connectors)

◆ Connect analog line-level output destinations (such as power amplifiers, crossovers, or speakers) to any of the output connectors on any SRO Card.

### Digital I/O

If your Stage Rack includes a digital I/O option, see “Digital Inputs and Sample Rate Conversion” on page 24.

## FOH Rack

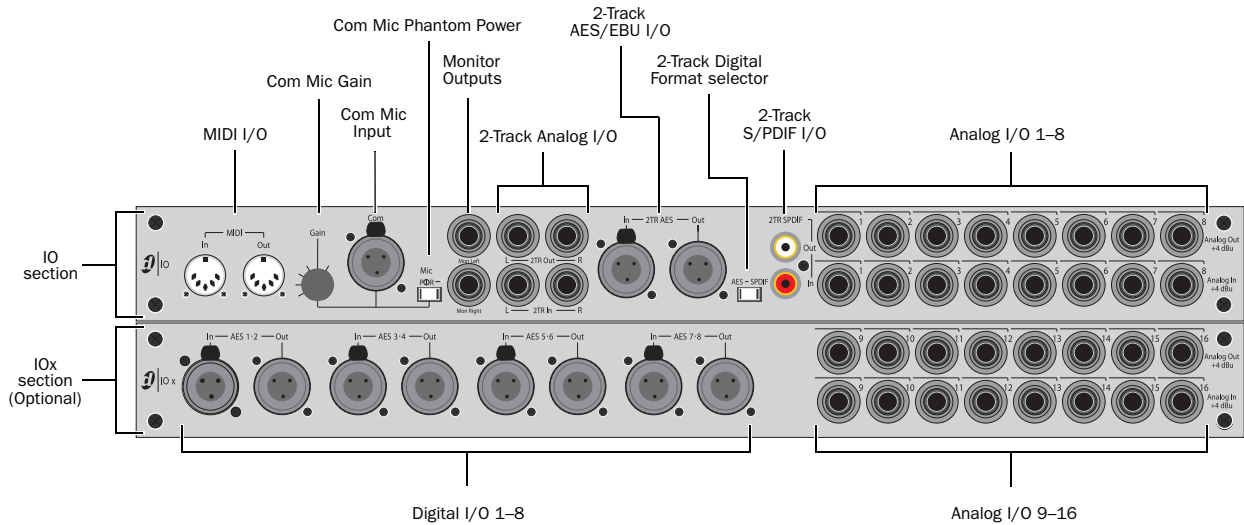

Figure 10. Audio connectors on FOH Rack, showing standard IO connectors (top) and optional IOx connectors (bottom)

### Analog Inputs and Outputs

#### (Balanced 1/4-inch TRS Connectors)

- ◆ Connect the analog inputs and outputs of external processors to any of these 8 analog output and input pairs. (16 inputs and output pairs are available if the IOx option is installed.)
- ◆ Connect any analog output destination (such as a recording device or broadcast feed) to any of the outputs in this section.
- ◆ Connect any analog sound sources (such as a CD player) to any of the inputs in this section.

### Digital Inputs and Outputs - IOx Option only

#### (AES/EBU Connectors)

- ◆ Connect the two-channel digital inputs and outputs of external processors to any of the 4 AES/EBU digital output and input connectors in this section.
- ◆ These connectors support 24-bit, 48 kHz digital signals. Input signals with other sample rates are sample-rate converted to 48 kHz.

### 2-Track Analog Inputs and Outputs

#### (Balanced 1/4-inch TRS Connectors)

- ◆ Connect a 2-track analog playback source to the 2-Track analog inputs.
- ◆ Connect a 2-track analog recording device to the 2-Track analog outputs.

### 2-Track Digital Inputs and Outputs

#### (AES/EBU and S/PDIF Connectors)

- ◆ Switch the 2-Track digital I/O between AES/EBU and S/PDIF by moving the 2-Track Digital Format selector switch to the corresponding position. Only one of these digital formats may be active at a time.

- ◆ Connect a 2-channel digital playback source to the 2-Track AES/EBU or S/PDIF input.

- ◆ Connect a 2-channel digital recording device to the 2-Track AES/EBU or S/PDIF output.

- ◆ These connectors support 24-bit, 48 kHz digital signals. Input signals with other sample rates are sample-rate converted to 48 kHz.

### Monitor Outputs

#### (Balanced 1/4-inch TRS Connectors)

- ◆ Connect a monitor amplifier or powered monitors to the Monitor Output connectors.
- ◆ The Monitor Outputs and the Headphone Output on the front of the console are fed by the Solo/Monitor bus

### Com Mic Connector

- ◆ Plug a dynamic or condenser microphone, or any compatible intercom system microphone into this connector.

### Com Mic Gain

- ◆ Turn the Com Mic knob to adjust overall Com Mic gain.

### MIDI Input and Output

- ◆ Connect a compatible MIDI device to the MIDI In and MIDI Out ports. Snapshots receive and send MIDI commands, and generate and respond to MIDI Time Code.

### Word Clock

If you are integrating digital devices with your VENUE system, make the necessary Word clock connections and settings. For details, see “Synchronizing External Digital Source Devices” on page 25.

## Profile Console Connections

This section describes the ports and connectors on the VENUE Profile console. Most connectors are on the Profile back panel.

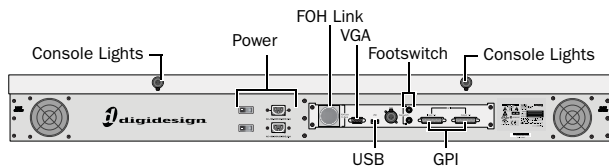

VENUE Profile back panel and connectors

### VGA Display

- ◆ Plug a compatible VGA display into this connector.

### USB Keyboard and Trackball

- ◆ Plug a compatible USB keyboard and Trackball (or mouse) into the two available USB connectors on the front the console (just below the faders for inputs 17–24).

### Other USB Devices

VENUE Profile provides USB ports on the top panel (near the meters) and on the back panel. Use these ports to connect iLok Smart Keys, USB flash disks or other compatible USB devices.

 *The Profile console provides USB 1.1 ports. For best performance, use the faster USB 2.0 ports on the Mix Rack or FOH Rack to connect USB flash disks for data transfer.*

### FOH Link

FOH Link connects Profile to the Mix Rack or FOH Rack. One FOH Link cable is included with each Mix Rack and FOH Rack.

### Power

Two male, 3-pin IEC power sockets with cable retaining clips are provided, one for each of the internal power supplies. Two standard IEC power cables are provided with each console.

### Footswitch 1 and 2

Two female 1/4-inch TS footswitch jacks are provided for switch input. Footswitches can be normally open or normally closed, latching or momentary. Functions are assigned to these jacks on-screen in the Options > Events page.

### Console Lights

Two XLR3-F jacks to connect to the included console lights.

## Talkback

A Talkback input (XLR) is on the top panel.

### Talkback Mic Connector

- ◆ Plug a dynamic or condenser mic into this connector.

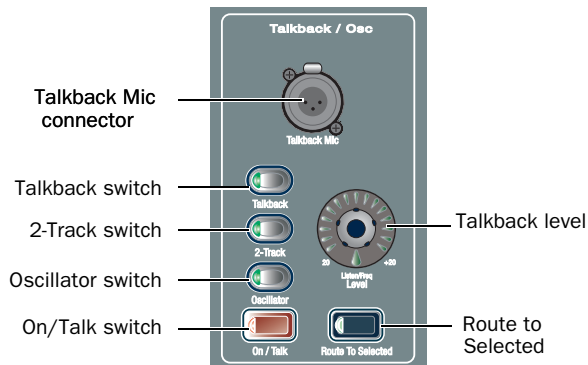

Talkback microphone connector and controls

### Talkback Level

- ◆ The talkback gain for this connector is fixed at 20 dB.
- ◆ Adjust talkback send level by pressing the Talkback switch in the Talkback/Osc section and turning the level knob.

### Talkback Switch

- ◆ Activate talkback by pressing the Talkback switch.

## CAN Bus

This XLR3-M connector is not functional.

## GPI Connections

VENUE Profile provides 8 channels of GPI input and output through separate 25-pin D-Sub connectors on the back panel.

 *For specifications, wiring diagrams and pinouts, see Chapter 29, “Control Surface Reference.”*

### GPI Applications

GPI inputs are connected to the outputs of a variety of switching devices such as footswitches, momentary or latching push-button switches, or logic outputs of a larger show control system. Example applications of GPI inputs include remote toggling of a console function such as Talkback, muting a channel, or recalling a specific snapshot.

GPI outputs connect to compatible inputs found on a variety of external devices such as LEDs, small relays, power sequencers, and logic inputs on show control systems.

Example applications of GPI outputs include the following:

- Triggering a sound effects playback machine when a specific snapshot is recalled.
- Lighting a tally light whenever a fader is raised above a minimum threshold.
- Flashing or lighting a custom beacon or LED as a reminder of vital console mode, such as Solo in Place.
- Initiating power up of amplifiers and other down-stream systems when VENUE Profile is started up or shut down.

GPI functions, as well as footswitch assignment, are managed using the Events List in the Options > Events window. For more information, see Chapter 22, “Events.”

**To connect GPI devices as triggering devices to Profile:**

- 1 Connect one end of a 25-pin D-Sub cable (not included) to the GPI IN port on the back panel of Profile.
- 2 Connect the other end to the appropriate GPI output port on the external device.

**To connect GPI devices to be triggered by Profile:**

- 1 Connect one end of a 25-pin D-Sub cable to the GPI OUT port on the back panel of Profile.
- 2 Connect the other end to the appropriate GPI input on the external device.

 For specifications, wiring diagrams and pinouts, see Chapter 29, “Control Surface Reference.”

---

## Powering Up the System

 *Faders move when power is turned on. Before powering up the system, make sure all fader paths are clear of obstructions.*

Power up the system in the following sequence:

- 1 VENUE Profile console
- 2 Racks:
  - Mix Rack
  - or –
  - Stage Rack, then FOH Rack
- 3 Any connected computers for recording/playback options
- 4 Audio monitoring system

 *Each power supply has its own power switch that must be in the On position in order to be powered up.*

---

## Powering Down the System

Power down the system in the following sequence:

- 1 Audio monitoring system
- 2 Any connected computers for recording/playback options
- 3 Racks:
  - FOH Rack, then Stage Rack
  - or –
  - Mix Rack
- 4 VENUE Profile console

---

## Setting the System Clock

When you first work with a VENUE system, make sure the system clock time, date and time zone are set appropriately. The system clock setting can affect data synchronization with portable storage devices. See “Transferring Settings, Shows and Presets” on page 175.

The system clock time can be shown in the Status bar for constant time-of-day display. For more information, see “System Clock” on page 63.

 *Changing the system clock while using a timed iLok license (for a plug-in with a demo period, or for a plug-in rental) may expire the plug-in authorization.*

## Enabling a Second Stage Rack

To enable and confirm communication with the second Stage Rack:

- 1 Put the system in Config mode.
- 2 Go to the Options page and click the System tab.
- 3 Click Edit.
- 4 Select Enable Stage 2, and click Apply. The system restarts.

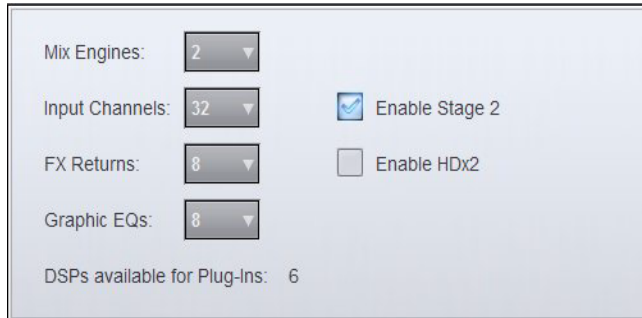

### Enabling the second Stage Rack

- 5 Go to Options > Devices to view hardware status. The connection to the second Stage Rack should be displayed in the FOH Rack graphic.

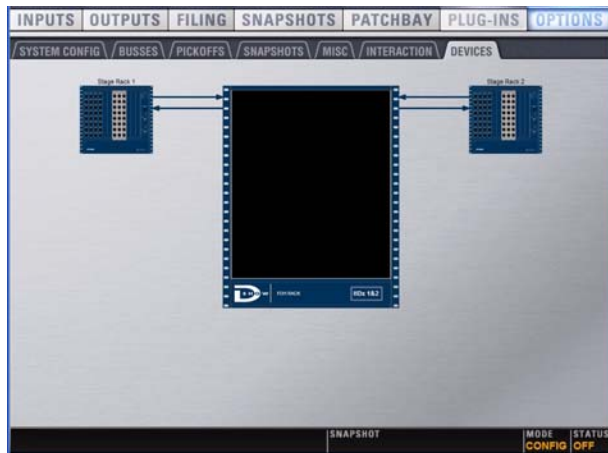

Detail of Devices page showing connection to second Stage Rack

 The second Stage Rack must be enabled for the Devices tab to display the correct number of input and output cards in that unit.

## Digital Inputs and Sample Rate Conversion

This section describes how to connect and clock external digital devices to VENUE systems.

 If your system includes the VENUE MADI option, see the VENUE MADI Card guide for more information.

### Overview

The types of digital I/O and connectivity available varies depending on your system components and their configuration:

**Mix Rack** The VENUE Mix Rack provides a pair of digital (AES) 2-Track inputs and outputs. The Mix Rack can also be expanded to include additional digital I/O (such as an XO16 card, to add 8 channels of analog output and 8 channels of digital (AES) output). Mix Rack also provides Word clock I/O.

**FOH Rack** VENUE FOH Racks provide many digital inputs and outputs, which can be expanded further by adding an IOx or VENUE MADI card. FOH Rack also provides Word clock I/O.

**Stage Rack** VENUE Stage Racks can be expanded by adding a DSI Digital Input card to add 8 channels of digital (AES or ADAT) input, and by adding a DSO Digital Output card for 8 channels of digital (AES or ADAT) output. DSI cards also provide Word clock I/O.

VENUE digital I/O (such as the DSI card) operates at the VENUE system sample rate of 48 kHz. The DSI card provides auto-detection and sample rate conversion on input, letting you connect a wide variety of digital sources without having to be concerned with synchronization and clock connections.

### Sample Rate Conversion Latency

When sample rate conversion is enabled on DSI or other VENUE digital inputs, input signal paths will incur a small amount of latency. The following table illustrates the sample rate conversion processing delay at various sample rates.

#### Minimum Additional Latency due to Sample Rate Conversion

External Sample Rate	SRC Process Delay
32 kHz	1.50 ms
44.1 kHz	1.09 ms
48 kHz	1.00 ms
88.2 kHz	0.848 ms
96 kHz	0.833 ms

Sample rate conversion (SRC) can also be disabled (DSI card only). This provides the lowest possible input path latency, but requires that care be taken to synchronize the source and other devices accordingly (see “Synchronizing External Digital Source Devices” on page 25).

Even when SRC is disabled, connecting an unsynchronized device to a DSI input causes SRC to automatically be re-enabled. This lets audio continue passing without interruption.

**To manually disable Sample Rate Conversion:**

- 1 Click the Inputs tab and navigate to the input channel being fed from a digital input.
- 2 Click the channel's SRC OFF button until it turns off.

**Auto-Detecting**

The DSI card (or other VENUE digital card) automatically detects whether an external device connected to a DSI input is synchronized to the VENUE system. Here, “synchronized” means the device is running at 48 kHz, and is clocked to the VENUE system (see “Synchronizing External Digital Source Devices” on page 25). In this case, no sample rate conversion is required on input.

If the external device is not synchronized, the VENUE system automatically engages sample rate conversion on those inputs *even if sample rate conversion was manually defeated*. The SRC LED flashes on the DSI card, and a message appears on-screen to indicate this condition.

 SRC status is not affected when an input channel is reset via right-click “Reset Strip” commands.

Sample rate conversion can be enabled or disabled manually for digital inputs, as follows:

- ◆ When using AES inputs on DSI cards, sample rate conversion can be enabled or disabled for each pair of inputs.
- ◆ When using ADAT (Optical) inputs on DSI cards, sample rate conversion can be enabled or disabled for all 8 channels. Enabling or disabling SRC on any ADAT channel enables or disables all other ADAT channels on that DSI card.

Switching input Source between AES and ADAT (Optical) ports retains the last sample rate conversion setting for that input type and channel (AES channel pairs only).

 Automatic detection and enabling of sample rate conversion is always in effect and will engage sample rate conversion whenever a mismatch is detected at a DSI input, even when sample rate conversion is manually defeated for that input.

**Synchronizing External Digital Source Devices**

When an external device is running at 48 kHz and clocked to VENUE, disabling sample rate conversion on those digital inputs provides the lowest possible input path latency.

Before sample rate conversion is defeated on any input connected to a digital source, that source device must be synchronized (clocked) at 48 kHz in one of the following ways:

**Using Word Clock Out from the Stage Rack**

**(Stage Rack with DSI Card)**

- ◆ Connect the Word Clock Out provided on the DSI card to the corresponding digital device. Set the external device to slave to the incoming word clock signal.

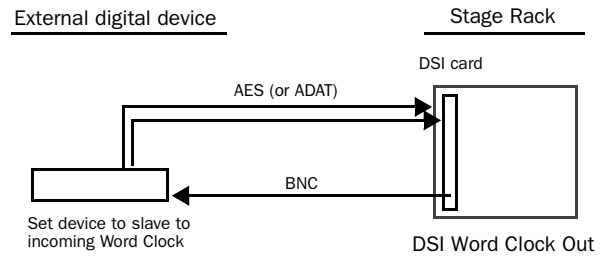

Using word clock from the DSI card to clock an external device

**Using Word Clock Out from the FOH Rack**

**(Stage Rack with DSI Card)**

- ◆ Connect the Word Clock Out on the FOH Rack to the corresponding digital device. Set the external device to slave to the incoming word clock signal.

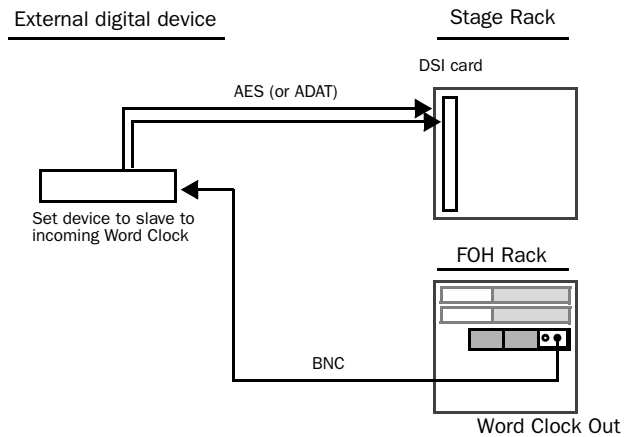

Using word clock from the FOH Rack to clock an external device



## Using Digital Audio Outputs from the VENUE System

◆ Connect any digital output to a digital input of the external device: Use digital outputs on the Mix Rack (if the system also includes an XO16 card), Stage Rack (if the system also includes a DSO card) or any digital output on the FOH Rack. Set the external device to slave to its digital input.

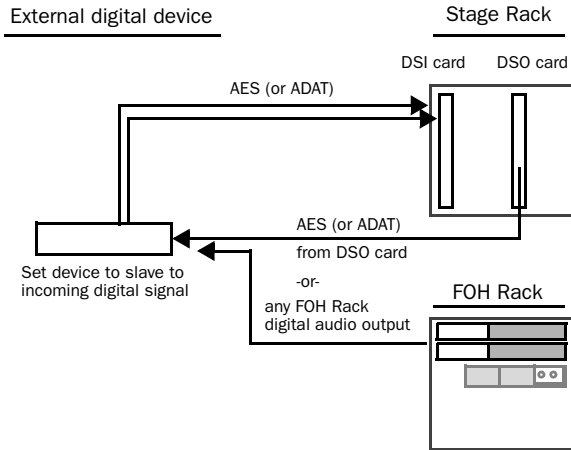

*Using a digital output to provide clock to an external device*

## Using House Clock

◆ Connect a “house” or other external master clock signal to the Word Clock In on the FOH Rack. Distribute the same house clock to the external digital device, and set it to slave to the incoming house word clock signal.

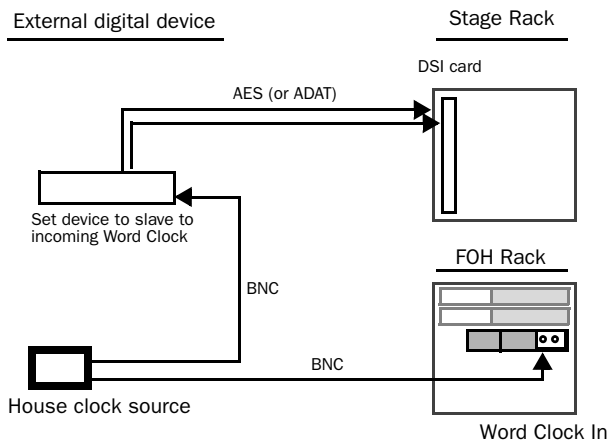

*Using a distributed house (master) to clock a VENUE system and an external device*



## **Part II: System Description**



# Chapter 3: VENUE Profile Control Overview

## VENUE Profile Top Panel

The following figure identifies the main sections of the Profile console:

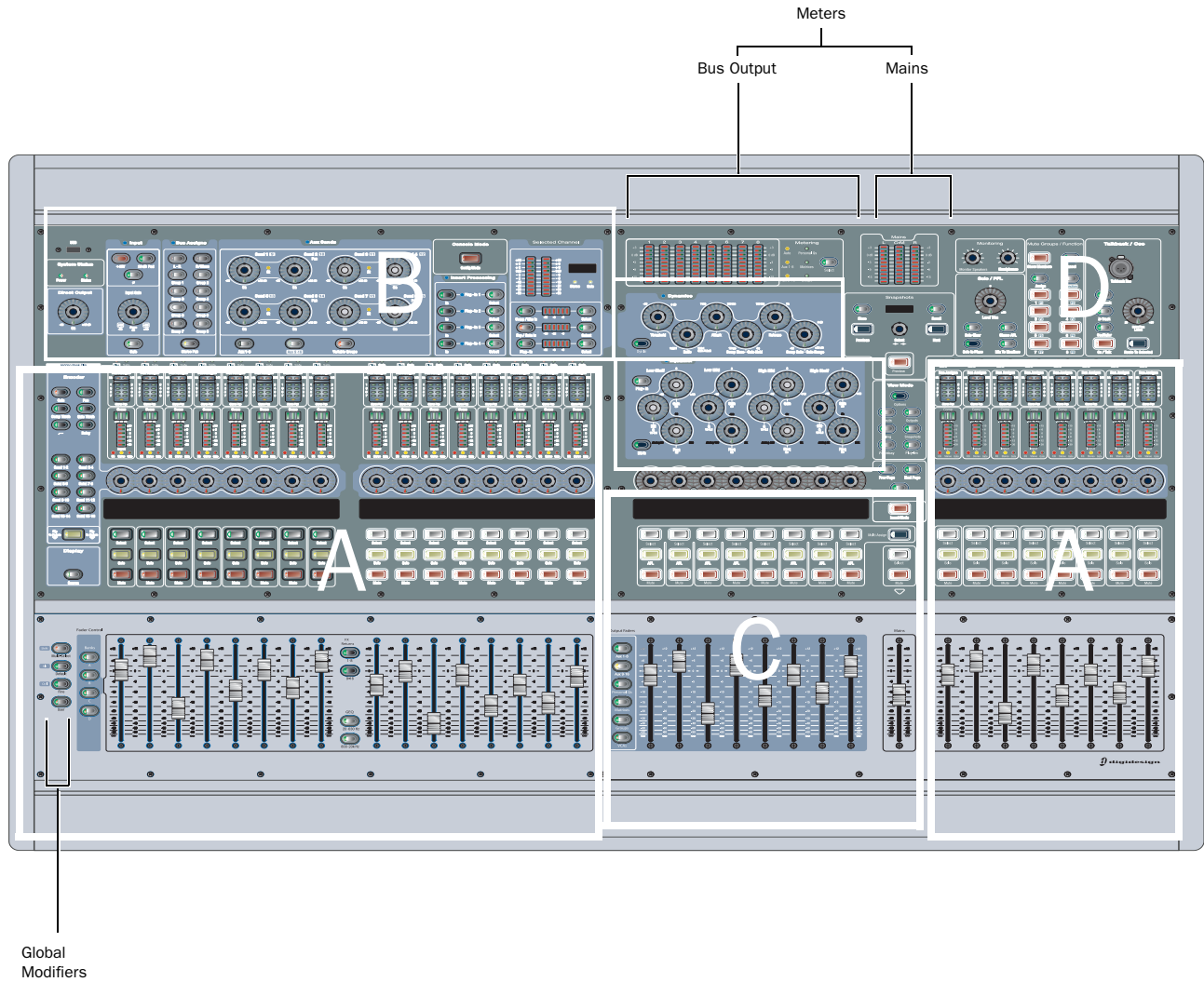

- A Input Channels 1–16 and 17–24
- B Assignable Channel Sections (ACS)
- C Output Masters Section
- D Master and Global Controls

Figure 11. VENUE Profile console

Profile provides 24 bankable input channel strips in *Input Channel* sections, an *Assignable Channel Section* (ACS), eight bankable output channel strips plus a Mains fader in the *Output Masters* section, as well as global controls and comprehensive metering.

## Input Channels and Faders

Input sections provide 24 faders and other controls for Input Channel and FX Returns. Input channels are arranged in two sections: Input channel strips 1–16 are to the left of the Output Master Section, while Input strips 17–24 are to the right. Additional channels are banked to the 24 faders using the Bank A, B, C and D switches. All 24 input channels bank together.

 *Input faders 1–16 can also be assigned to control FX Returns 1–8 or 9–16, or the output EQ (graphic EQ).*

Each input channel strip includes a channel fader, channel Select, Mute and Solo switches, a rotary encoder, LCD display area and meters for channel level and gain reduction. The encoders and associated assignment switches access Gain, Pan, HPF, Compressor and Gate thresholds and Aux sends. Each bank of eight input channels provides a two-row LCD display that shows channel name, parameter names, values and other data as appropriate for the current action.

Additional input parameters are controlled by selecting one or more channels to make them the target of the ACS.

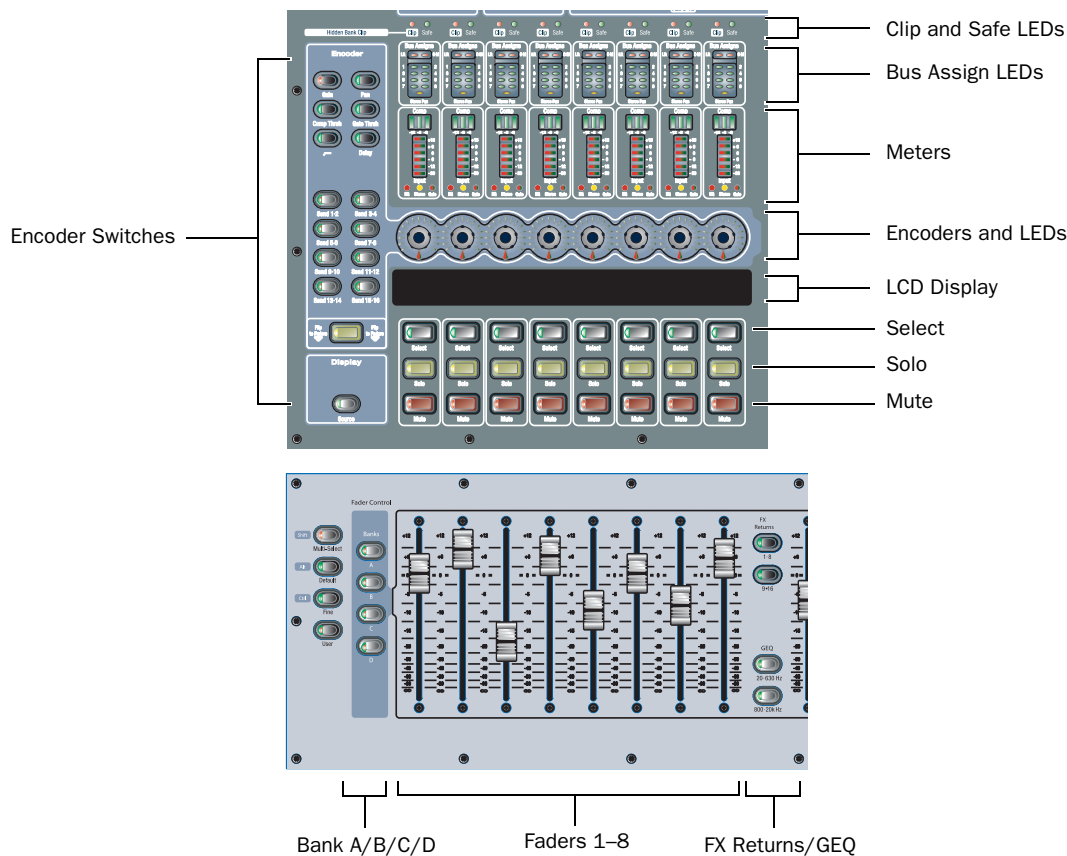

Figure 12. Input controls (Input Channels 1–8 shown)

### Clip LED

The Bank Clip Indicator lights to indicate a meter clip on an Input Channel or FX Return at the corresponding position in an alternate bank of channels. This indicator obeys the same clipping threshold display rules as the Input Channel meters (as set in the Options > Interaction page). It gives you an indication of extreme signal level in a currently hidden (“off-bank”) layer.

### Safe LED

#### Automation Safe, Solo Safe, or Bank Safe

The Safe LED indicates either an input strip’s Automation safe status, Solo safe status, or Bank Safe status, depending on the current Input Safe Switch setting. See “Input Safe Switches” on page 65

**Auto Safe Mode** If the Safe LED is lit, the channel will not respond to Snapshot-driven changes. If the LED is off, that channel will respond to any applicable changes driven by Snapshots (subject to the current Recall Safe settings, if Recall Safe is enabled).

**Solo Safe Mode** If the Safe LED is flashing, the channel will not respond to solo commands (it will not be muted if another channel's solo button is pressed). If the LED is off, that channel will be silenced when soloing another channel.

**Bank Safe Mode** If the Safe LED is flashing rapidly, the channel remains in place on the top fader layer when a different Bank (A–D) is selected (it will be unlinked from console banking). If the LED is off, the channel follows banking.

Pressing a channel Safe switch for the Selected Channel toggles the current state of that channel.

## Bus Assignment Indicators

These green LEDs indicate Group bus assignments, and can also show VCA or Mute Group membership for each channel. By default, Group bus assignment is displayed.

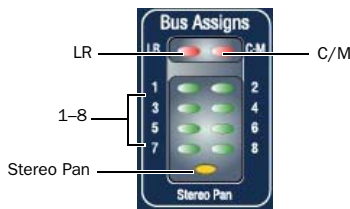

Bus Assign indicator LEDs on an Input Channel

### Group Bus Assignment

- ◆ If the LR LED is lit, the input channel feeds the Left and Right Main busses in either L–R or L–C–R panning mode (regardless of the Stereo Pan LED status).
- ◆ If the C/M LED is lit, the input channel feeds the C (center) bus from the pan in L–C–R mode, or the M (mono) bus before the pan. Stereo channels are summed to the mono bus.
- ◆ If a bus LED (1–8) is lit, the channel is feeding the corresponding Group(s). If an LED is off, the channel is not feeding that Group. The Bus Indicators can also show VCA and Mute Group membership.

 Use the Bus Assign switches to route and assign the currently selected channels to busses (see “Assignable Channel Section” on page 34).

### VCA Membership

- ◆ When VCA Show Members mode is enabled, Group indicators flash to indicate VCA membership.

### Mute Groups

- ◆ When the Mute Groups Show Members switch is pressed, the Group indicators flash to indicate Mute Group assignments. A flashing LED indicates that the channel is assigned to the corresponding Mute Group (1–8).

### Stereo Pan LED

This LED indicates when the channel is assigned to a stereo Groups bus.

## Input Channel Metering

Each Input Channel provides a gain reduction meter, input level meter, and LEDs to indicate EQ, Gate, and stereo status.

### Comp Gain Reduction Meter

A 3-segment meter displays gain reduction for the channel compressor/limiter. Green LEDs are used for all segments.

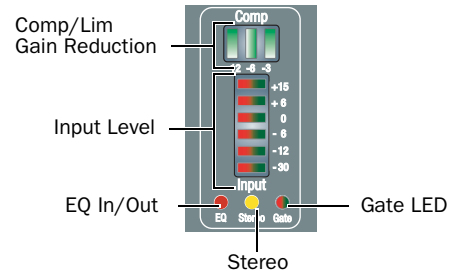

Input channel meters and LEDs

### Input Level Meter

A 6-segment meter displays input level and indicates clipping. Bi-color LEDs are used for all segments, as shown in the following table. Clipping is indicated when all LEDs light red.

 For meter scales, see “Channel Meters” on page 115.

### EQ Status LED

A single red LED indicates EQ In/Out status as shown in the following table.

Color	EQ Status
(none)	Not in circuit
Red	In circuit

### Stereo Channel LED

A single yellow LED indicates a stereo input channel. The stereo channel LED flashes if a 10 dB or greater offset is detected between left and right inputs.

Color	Channel Status
(none)	Mono
Yellow	Stereo

### Gate Status LED

A single bi-color LED shows the current Expander or Gate status. For LED scales, see “Gate Status LED” on page 115.

## Input Encoders and Assignment Controls

Each input channel features one assignable input encoder that can be assigned to control a variety of channel functions such as input gain, HPF corner frequency, pan/balance/width, and specific parameters of built-in Dynamics processes.

The Encoder Assignment switches, located to the left of the row of encoders, determine the function of the encoders on Input Channels. The LCD displays the current function (see “Input Channel LCD Display” on page 33).

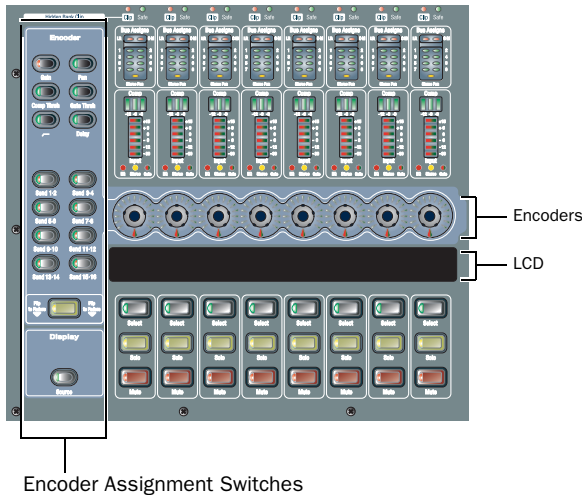

Input encoders, assignment switches, and LCD

### Rotary and Switch Functionality

The rotary encoders on VENUE consoles are dual-function controls that provide rotary and switch functions. In addition to adjusting parameters by turning the encoder, you can toggle parameters (such as taking the high-pass filter in or out of circuit) by pressing the encoder knob.

### Encoder LEDs

Two types of LEDs surround each encoder:

- ◆ The LED ring around the encoder displays the relative position of its currently assigned parameter.
- ◆ Below each encoder is an indicator LED, which indicates parameter status (in/out), default setting, or other conditions related to the current encoder function.

Switches in the Encoder section assign each of the following parameters to the Input encoders:

### Gain

Gain assigns the encoders to control input gain according to the range available for this input (head amp gain for analog inputs, digital gain for digital or line inputs). Pressing and holding the encoder initiates Gain Guess, in which the VENUE system automatically sets a nominal input gain level based on the incoming signal.

### Pan

Pan assigns the encoders to control channel Pan if the channel is mono, or stereo channel balance if a stereo. The indicator LED lights when the pan is at center.

### Comp Thrsh

Comp Thrsh assigns the encoders to control the Threshold for the built-in Compressor/Limiter. Pressing the encoder toggles the effect in and out of circuit. If the LED is lit the effect is in circuit.

### Gate Thrsh

Gate Thrsh assigns the encoders to control the Threshold for the built-in Expander/Gate. Pressing the encoder toggles the effect in and out of circuit. If the LED is lit the effect is in circuit.

### HPF

HPF assigns the encoders to control the HPF corner frequency. Pressing the encoder toggles the built-in HPF in and out of circuit. If the LED is lit, the filter is in circuit.

### Delay

The Delay switch assigns the encoders to control the amount of delay in the channel. Pressing the encoder toggles the Delay in and out of circuit. If the LED is lit, the delay is in circuit.

### Send 1–2 to Send 15–16

These switches let you select one of two Aux sends in odd/even pairs (Send 1–2 through Send 15–16) or Variable Group sends in odd/even pairs (Send 1–2 through Send 7–8 only).

- ◆ With mono sends, the first press of the switch selects the odd numbered send (1, 3, 5, or 7) and the second press selects the even numbered send (2, 4, 6, or 8). The switch lights green for the odd-numbered selection, or yellow for the even-numbered selection.
- ◆ With stereo-linked sends, the first press of the switch controls level for the bus pair, and the second press controls pan for the bus pair. The switch lights green for level control, or yellow for pan control.

Pressing an encoder toggles the send on or off. When the send level is shown on the LED ring and the send is off, a single LED lights. When the send is on, all LEDs light in a clockwise sequence from the lower left to the send level.

## Flip to Faders

When enabled, the current encoder parameter is mapped to the channel faders. It can still be controlled from the encoder row, so the channel fader mirrors the setting. When Flip is engaged, all channel name display backlights turn yellow, the same color as the flip switch. Channel name is displayed in the upper row of the LCD, with the flipped parameter displayed in the lower row (mirroring the effect of Flip to Faders).

 *Flip to Faders provides a special mode when working with stereo Aux sends. For information, see Chapter 10, “Aux Sends and Variable Groups.”*

## Input Channel LCD Display

There are a total of three Input Channel LCD displays, one each for Inputs 1–8, 9–16 and 17–24.

Each LCD provides two rows of data with six characters per row, per input channel. The upper and lower rows let you see more than one type of channel data simultaneously, such as channel name in the lower row and fader dB level in the upper row while you adjust the fader. Data display depends on the current encoder assignment.

### Input Encoder Assignments and Values

The current encoder assignment, parameter or value is displayed in the top row of the input displays. There are two states the top row can be in: Parameter Value mode and Parameter Name mode.

When necessary, the display abbreviates displayed functions as shown in the following table.

**Table 4. Encoder Assignment Displays**

Switch	Display
Gain	Input Gain
Pan	Input Pan
Comp Thresh	Compressor Threshold
Gate Thresh	Gate Threshold
	HPF Frequency
Delay	Input Delay
Send (n)	Aux (n) Level Aux (n) Pan (stereo-linked sends only) Variable Group (n) Level Variable Group (n) Pan (stereo-linked sends only)
Flip to Faders	Aux (n) Level and Pan (stereo-linked sends only)

## Source Switch

The Source switch in the Display section changes the Channel Name display to show the source input which is feeding each channel. For example, “S1 17” indicates the channel source is Stage Rack 1, Input 17.

## Select Switch

The Select switch on each channel is used to target the channel in the Selected Channel sections, and to include the channel in Multi-Select and Multi-Assign functions. A lit Select switch indicates the channel is selected. The name of the currently selected channel is displayed in the Channel Name display and in the Selected Channel display. When multiple channels are selected, the Channel Name display indicates which channel is the ACS target.

## Solo Switch

The Solo switch toggles the solo state of that channel. When enabled, the Solo switch LED is lit. When the channel is in Solo Safe mode, the Solo switch LED flashes. Channel Solo latches on a momentary press, and automatically releases if held for 2 seconds or more and released.

## Mute Switch

The Mute switch mutes the channel at the (pre-fader) mute point. Channel pre-fader pickoff is post-mute.

## Input Faders and Banking

Each channel fader is a 100mm motorized, touch-sensitive fader.

The Options > Interaction screen lets you enable touch-sensitive channel selection. When enabled, touching a channel fader automatically selects that channel and makes it the Selected Channel

 *The faders on the Profile console can be moved even when they do not sense a touch. This allows use of the faders while wearing gloves. It also lets you “throw” a fader and have it stay where it lands, and not snap back to the point it was last touched.*

### Fader Banking Controls

**Bank A–D** Banks the Input strips. Up to four banks (A through D) can be used to access up to 96 inputs from the 24 Input Channel faders. Bank A is channels 1–24, Bank B is channels 25–48, and so on.

**FX Returns** Banks FX Return channels 1–8 to Input faders 1–8, or FX Returns 9–16 to Input faders 9–16.

**Graphic EQ** Banks bands of graphic EQ to the faders. Graphic EQs can be used on outputs only. For more information, see Chapter 17, “EQ.”

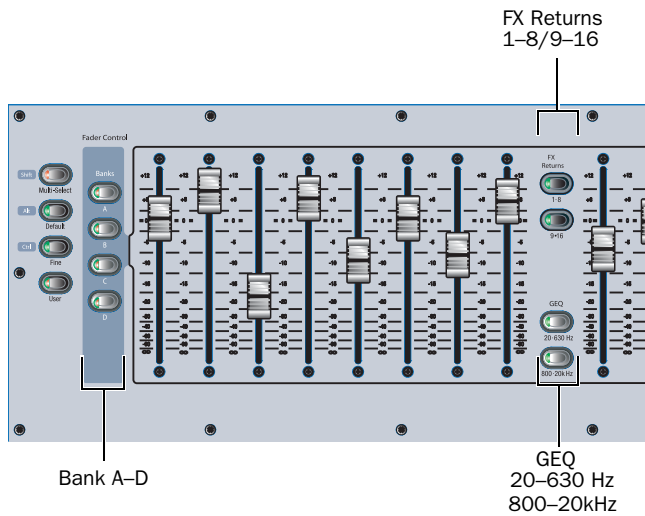

*Input fader banking and assignment switches*

## Global Modifier Switches

To the left of the Bank A–D switches are the global modifier switches. See “Global Modifier Switches” on page 41.

**Multi-Select** (Shift) Lets you select multiple input channels, and lets you select multiple items in lists.

**Default** (Alt) Lets you reset a parameter, section, or channel to default values. This switch also enables certain modes such as Show VCA Members mode.

**Fine** (Ctrl) Lets you select non-adjacent items in lists, or adjust rotary encoders with greater resolution for finer control.

**User** This switch is currently not implemented.

## Assignable Channel Section

The Assignable Channel Section provides dedicated routing, EQ, Dynamics, and insert controls for the currently selected channel. ACS sections include the Input, Bus Assign, Direct Out, Aux Sends and Inserts sections, the Selected Channel Meters and display, and the Dynamics and EQ sections.

The ACS sections feature a light colored background color, and each section features a blue LED which, when lit, indicates that section applies to the selected channel.

### Input

This section provides a Clip LED, and controls for phantom power, input pad, polarity (phase), gain and safe status.

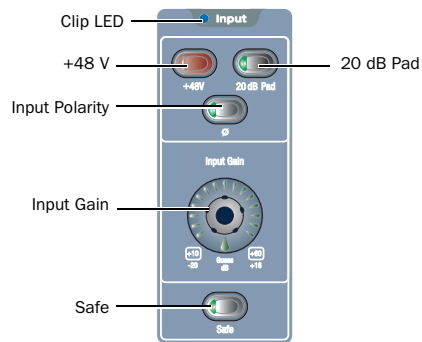

*Input controls*

### Direct Output

The Direct Output section provides level and in/out control for the channel direct output.

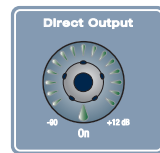

*Direct Output*

### Bus Assigns

The Bus Assigns switches are the primary routing controls for the currently selected channel, letting you bus it directly to the Mains (L–R) bus or to any other mono or stereo group.

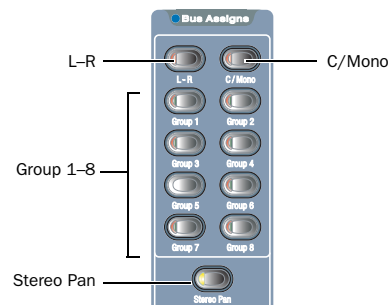

*Bus assign switches*



## Aux Sends

The Aux Sends section provides in/out and level control to route the currently selected channel to any available mono or stereo-linked Aux bus. The Aux Sends section is banked using the Aux 1–8 or Aux 9–16 switches.

The Variable Groups switch accesses Variable Groups mode. When D-Show is in Variable Groups mode, the controls for Aux 1–2 through Aux 7–8 route to Variable Groups 1–2 through 7–8 respectively. The Variable Groups switch also automatically toggles the input encoders to Variable Groups 1–8 (instead of Auxes 1–8).

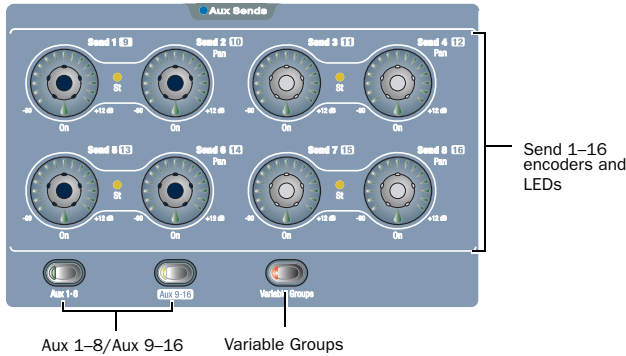

Aux send controls

## Insert Processing

The Insert Processing section provides controls to bypass and select plug-ins on the currently selected channel.

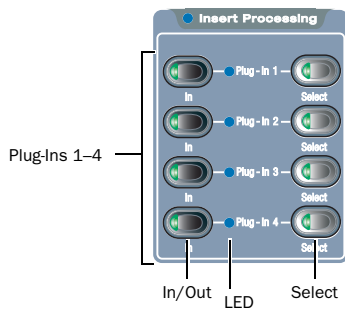

Insert Processing controls

## Selected Channel Meter, Display and LEDs

The Selected Channel display section includes two 10-segment Selected Channel meters, a 6-character LCD display and LEDs for Status and Solo state.



Selected Channel meters, displays and LEDs

The 6-character Selected Channel display shows the name of the currently selected channel. The Selected Channel display temporarily reverts to a parameter display mode any time an encoder is adjusted on the selected channel.

The Stereo LED lights solid when a stereo input or output is targeted. The Solo LED flashes any time a channel is in PFL, AFL or Solo in Place mode.

The dual, 10-segment, bi-color LED meters indicate input level and clip status for the currently targeted or Soloed channel.

 For Selected Channel metering scale, see “Selected Channel Level Meters” on page 116.

## Dynamics

The Dynamics section provides dedicated controls and metering for built-in and plug-in dynamics processors, including a comprehensive set of Compressor/Limiter and Expander/Gate controls.

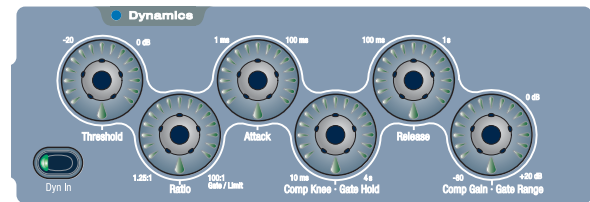

Dynamics section and controls

 See Chapter 16, “Dynamics.”

## EQ

The EQ section provides dedicated controls for all built-in and compatible plug-in EQ parameters including band in/out, frequency, Q, and mode.

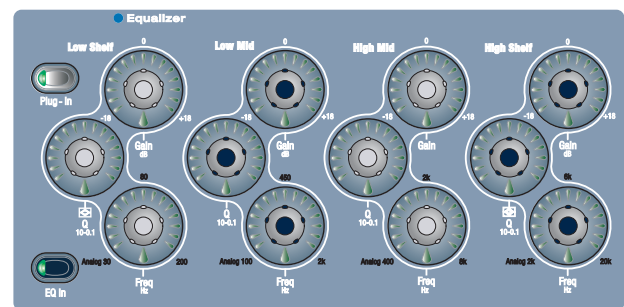

EQ section and controls

 See Chapter 17, “EQ.”

## Output Masters

The Output Masters section includes eight bankable output channel strips, each with a fader, encoder and channel switches. The Mains fader provides master level control over the Mains (house) output.

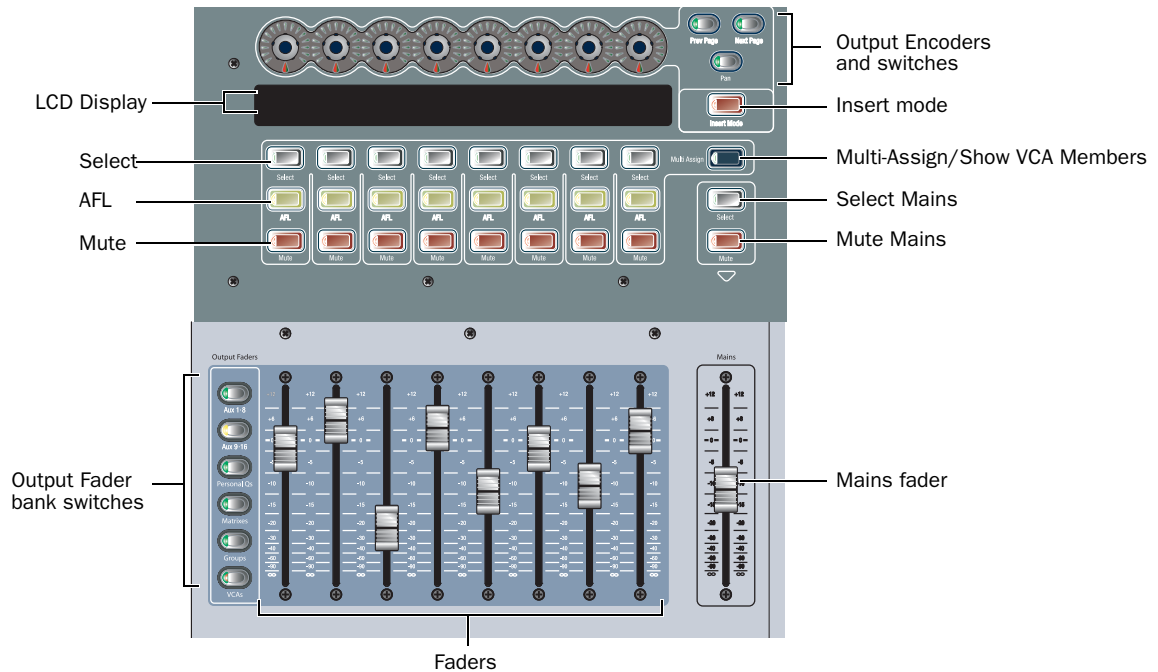

Figure 13. Output controls

### Mains Fader

The Mains fader provides a single level control for the current Mains output.

### Output Faders

The eight Output Faders control level for Aux 1–8, Aux 9–16, Personal Q, Matrix and Group busses, and VCAs.

### Output Fader Bank Switches

The Output faders and encoders are banked to the desired bus using the Output Faders switches.

**Aux 1–8** Assigns the Output Faders to Aux 1–8 levels.

**Aux 9–16** Assigns the Output Faders to Aux 9–16 levels.

**Personal Q's** Assigns the Output Faders to PQ mixer output levels.

**Matrixes** Assigns the Output Faders to Matrix mixer output levels.

**Groups** Assigns the Output Faders to Group levels. When in Variable Groups mode, this switch assigns the Output Faders to control Variable Groups.

**VCAs** Assigns the Output Faders to VCAs.

### Mute, AFL and Select Switches

Above the faders are the Mute, AFL and Select switches, which mute, solo, and select Auxes or Groups assigned to the Output section.

### Output Encoders and Display

The eight Output Encoders adjust additional Output bus controls such as Group pan, Matrix source and PQ source level, as well as plug-in parameters (when in Inserts mode).

The Output Masters LCD display is a two-row display that is capable of showing 6 characters in each row, per output bus. The display shows the name, parameter or value currently being controlled in the Output Masters section.

The Prev Page and Next Page switches light to indicate additional functions depending on the selected output or plug-in parameter. When lit, pressing either switch scrolls the Output Encoders to the previous or next output or plug-in parameters. The Inserts Mode switch puts the encoders in Inserts mode, in which the Output encoders select and adjust plug-ins.

## Master and Global Controls

Global and master controls are located in sections with a dark background, and include the Snapshot, View Modes, Console Config, Mute Groups/Function, Monitoring and Talkback/Osc sections in the upper right quadrant of the control surface. In addition, the global Modifier switches for Multi-Select, Default and Fine are located next to input faders 1–16.

## Global Modifiers

The Modifiers section is located to the left of Input faders 1–8, and provides the Multi-Select, Default, Fine and User switches.

## Snapshots

The Snapshots section provides Store, Recall, Previous, Next, and Preview mode switches, along with a Select encoder and a 6-character Snapshot LCD display.

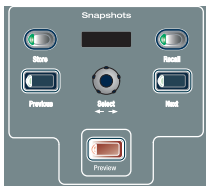

Snapshots

 For more information, see Chapter 21, “Snapshots.”

## View Modes

The View Mode switches (Inputs, Outputs, Filing, Snapshots, Patchbay, Plug-ins) display the corresponding pages on-screen. Pressing a View Mode switch repeatedly cycles through the individual tabs of that page. For example, pressing the Patchbay switch once displays the Patchbay page. Pressing Patchbay again cycles through various tabs within the Patchbay page.



View Modes

## Console Mode

The Config Mode switch toggles the system between Config and Show modes.



Console Mode

## Talkback/Osc

The controls in this section provide comprehensive and flexible communication control, including a top-mounted Talkback input (XLR), Assign switches, and level control.

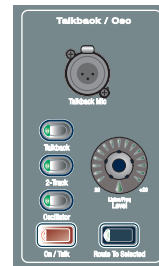

Talkback/Osc

## Mute Groups/Function

Provides Mute Group assignment and selection in default Mute Groups mode, or can be switched to provide eight Function switches (F keys) in Function mode. The global Cancel switch is also located in this section.



Mute Groups/Function section

## Mute Groups

Mute Groups let you quickly mute multiple channels at the same time. You can create and recall up to eight Mute Groups comprising one or more channels.

 See Chapter 15, “Muting and Mute Groups.”

## Function Switches

In Function mode, this section provides eight Main Function switches. The default assignments for the first four Function switches include Preview mode on/off (F1), Variable Groups (F2), Copy (F3) and Paste (F4).

 Function switches can be assigned to perform any number of actions using the Events window. For more information, see Chapter 22, “Events.”

## Cancel

This switch cancels the current operation, such as Multi-Select or Multi-Assign modes.

## Monitoring

The Monitoring section provides level encoders for the Monitor (near field monitors) and Headphone outputs.

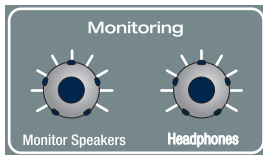

### Monitoring controls

Monitor bus delay can be set on-screen in the Options > Buses page.

## USB Port and System Status LEDs

These LEDs indicate power and system status. These controls are located in the upper left corner of the control surface.



Top panel USB port and status LEDs

 For more information, see Chapter 28, “Troubleshooting.”

## Meters

The Meter section includes the following:

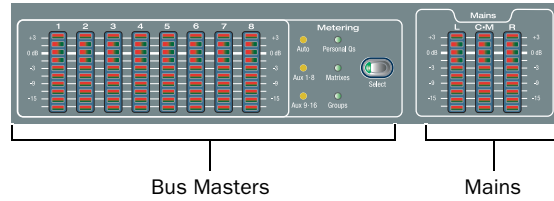

### Meters

## Bus Output Meters

Eight Bus Output meters provide selectable metering of Output busses.

## Mains

The Mains meters provide constant level indication of the house (Mains) output.

 For more information, see Chapter 13, “Metering.”

# Chapter 4: Basic Commands and Modes

## Control Overview

Most features and controls that are used during a performance are available from both the console and on-screen. Changes made on one are immediately reflected in the other, letting you use almost any combination of console and screen controls to mix.

The software screen is not required in order to mix a performance, as all essential mixing controls are provided on the console. However, the screen is essential when setting up and configuring the system before a performance.

## Software-Only Controls and Displays

Many configuration settings and options are only available on-screen, including hardware configuration settings, busses, plug-in installation, and system diagnostics. For more information, see “System” on page 57.

## Software Screen Banner Display

The software screen provides a banner display in the lower left corner. This display is provided to maintain line-of-sight mixing by showing the currently adjusted parameter (such as fader level or compression threshold) as you make changes to the parameter. The banner display also provides Tool Tip text and status messages.

## Tool Tips

With the mouse or trackball, place the cursor over a screen item to see a brief explanation in the banner display.



Status bar showing Tool Tip

## Status Messages

The banner display alerts you to certain operating conditions such as Multi-Select and Multi-Assign modes.



Banner display

Mode display

Banner display showing current state of the system

## Console and Software Screen Linking

The software screen is linked to console actions by default. For example, selecting an input channel on the console changes the screen to the Inputs page, and selecting an output bus changes the screen to the Outputs page. You can customize how the system targets channels to best match your working style. For more information, see “Interaction” on page 64.

---

## Config Mode and Show Mode

There are two main operating modes, Config Mode and Show Mode. Use Config mode to set up your system and options; use Show mode to mix your performance.

### Config Mode

Config mode provides access to the configuration settings that are typically performed as part of system setup (before mixing). For example, you must be in Config mode to do any of the following:

- Choose a Main mix format (L-R+M, or L-C-R)
- Designate the number and mono/stereo format of available auxes and groups, combine two mono channels into one stereo input channel, or split a stereo input channel into two mono channels.
- Install plug-ins
- Assign plug-ins in the software racks
- Route side-chain inputs to plug-ins
- Initialize (or reset) hardware devices and options
- Change Matrix and PQ Source pickoff points
- Change Master Insert points
- Customize console and software interaction
- Move channels to different fader strips
- Perform system tests and diagnostics

**▲** Some Config mode operations interrupt audio throughput.

### Show Mode

Show mode is the main operating mode for the system software. All mixing and routing features are available, based on your settings made in Config mode.

## Toggling Between Config Mode and Show Mode

**To put the system into Config mode or Show mode, do one of the following:**

- Press the Console Mode switch (located near the top center of the console, above the Insert Processing section). When the switch LED is lit, the system is in Config mode.

– or –

- Double-click the Mode display in the Status Bar, located in lower-right hand corner of the screen.

---

## System Lock

System Lock locks out all manual changes (console and screen actions), allowing the operator to safely step away from the system. Audio continues to pass but is not affected by console controls until the operator disables System Lock.

(System Lock is not available in the Standalone software.)



System Lock button on the Options > System page

## Locking and Unlocking the System

### To engage System Lock:

- 1 Go to the Option > Systems page.
- 2 Click the Lock button in the System section.
- 3 In the dialog that appears, click Lock.

On the console, the LCDs for each 8-channel fader bank display System Locked.

On-screen, an Unlock button appears in the lower right corner in front of a dimmed background image.

 You can add your own custom images to display in place of the default VENUE logo. See “Customizing the System Lock Display” on page 41 for information.

### To unlock the system (disengage System Lock):

- Do either of the following:
  - Press and hold the Cancel button on the console for two seconds.
  - or –
  - Click Unlock in the lower right corner of the screen.

 The Unlock button is hidden after a few seconds. Touch the mouse or keyboard to bring it back.

## System Status while Locked

**GPI** All console GPI inputs and outputs are disabled while the system is locked.

**Footswitches** All Footswitch inputs are disabled while the system is locked.

**Events** All Event triggers and actions that include console or GPI/Footswitch functions are disabled while the system is locked.



## MIDI and MTC

While the system is locked:

- Snapshots continue to be recalled via MTC, either internally or externally generated.
- The system continues to respond to snapshot changes via incoming MIDI program change commands if the Snapshots Respond option is selected on the Options > Snapshots page.
- The system continues to send MIDI program changes when a snapshot is recalled if the Snapshots Send option is selected on the Options > Snapshots page.
- The system continues to send MIDI messages stored within snapshots, provided the MIDI data type is scoped.

 MTC can be disabled using the CHASE MTC button on the Snapshots page. Also, the sending and receiving of MIDI data can be turned off by deselecting the MIDI options on the Options > Snapshots page.

## Customizing the System Lock Display

You can manually add one or more custom images to display during System Lock, rather than the default VENUE logo background.

Multiple images are displayed one after the other for 20 seconds in a random order. (Pressing the Spacebar advances to the next image immediately.)

### To install custom System Lock images:

- 1 Copy a .bmp or .jpg image file to a USB key disk or CD-ROM. (For optimal results image resolution should be 1024 x 768; smaller or larger images can be used, but will be centered or scaled, respectively.)
- 2 Put the system into Config mode.
- 3 Go to the Options > System page.
- 4 Ctrl-click the Shutdown button.
- 5 Copy the image from your USB key disk to the following location on the system drive:  
User Data\D-Show\Images
- 6 Double-click the Return to D-Show icon on the Desktop to restart VENUE software.

## Global Modifier Switches

VENUE Profile provides a set of global modifier switches: Multi-Select (Shift), Default (Alt), Fine (Ctrl) and User. These are located to the left of the input faders

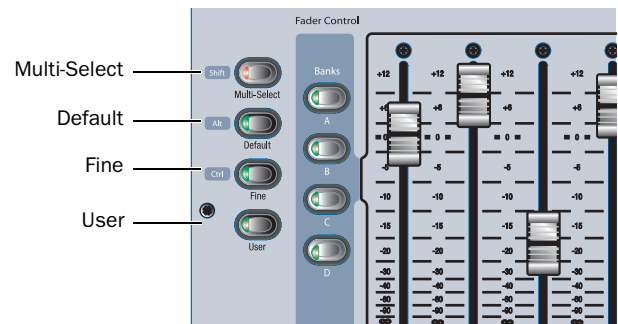

### Global modifiers

These switches provide frequently used shortcuts that can be applied to console actions and software screen interactions.

## Multi-Select Switch

The Multi-Select (Shift) switch lets you select multiple Input Channels and then apply an action to all selected channels. Multi-Select is useful for batch routing and assignment of input channels.

Most channel functions support Multi-Select (or Multi-Assign) as noted throughout this guide. For details, see “Selecting and Targeting Channels” on page 48.

## Default Switch

The Default (Alt) switch provides a quick way to reset a control to its default setting (or “zero” the setting). It is equivalent to, and interchangeable with, the Alt key on the keyboard.

### Examples of Using Default

#### To reset a fader to 0 dB:

- 1 Press and hold the Default switch.
- 2 Press the Select switch on the channel you want to reset.

#### To reset a single EQ parameter:

- Hold the Default switch and press the encoder or switch for that parameter.



To reset a parameter using only the keyboard and trackball, Alt-click the on-screen control.

## Fine Switch

The Fine (Ctrl) switch lets you adjust controls (except for faders) on the console or on-screen with maximum resolution. For example, if by default a control adjusts a parameter in units of 1 dB, the Fine switch allows adjustment in units of 0.1 dB.

### To adjust a control with fine resolution:

- Press and hold the Fine switch while moving a control. The display associated with the adjusted control will show the values change at the corresponding resolution.

## Momentary and Latching Modes

The Fine switch supports momentary and latching operation.

**Momentary** In momentary mode, the Fine switch stays in effect for as long as you hold down that modifier switch.

**Latching** In latching mode, the Fine switch stays in effect until you explicitly clear its active state.

### To use the Fine switch in Momentary mode:

- 1 Press and hold the Fine switch.
- 2 Adjust a channel, parameter, or processor.
- 3 Release the Fine switch.

### To use the Fine switch in latching mode:

- 1 Double-press the Fine switch. The switch LED lights.
- 2 Select or adjust one or more channels, parameters, or processors.
- 3 Press the Fine switch again to exit latching mode.

## User

The User switch is reserved for future use.

## Software Screen Pages and Tabs

### Viewing Pages

To view a page, do one of the following:

- Press a View Mode switch.
  - or –
- Click the page name at the top of the screen.

When additional tabs are available for a page, go to those tabs by pressing the corresponding View Mode switch again to cycle through the tabs on that page, or by clicking their names on-screen.

Click page name to display



Viewing pages



## Overview of Software Pages

The software screen provides the following pages and tabs.

### Inputs

Select, name, configure, and adjust parameters for input channels and FX Returns.



Inputs page (analog input shown)

See Chapter 7, "Inputs and Input Routing."

### Outputs

Select, name, configure, and adjust parameters for outputs.



Outputs page

See Chapter 8, "Outputs and Output Routing."

### Filing

Load, save, and transfer shows and presets, and access the console History.

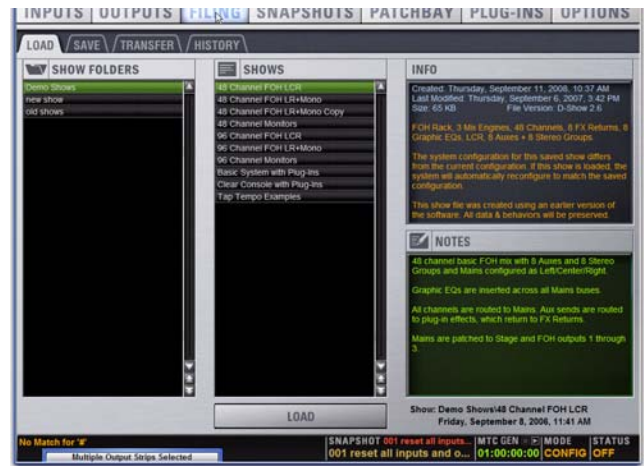

Filing (Load tab)

See Chapter 20, "Shows and File Management."

### Snapshots

Store and recall snapshots, and access the Recall Safe window.



Snapshots page

See Chapter 21, "Snapshots."

## Patchbay

Label your channels and assign input and output patching.



Patchbay (Outputs tab)

See Chapter 12, “Patchbay.”

## Plug-Ins

Configure and arrange plug-in racks by assigning plug-ins; patch/route and manage plug-ins.



Plug-In page

See Chapter 18, “Plug-Ins.”

## Options

Configure system, routing and metering options, set interaction, hardware and general preferences, install plug-ins, and access the Events window.

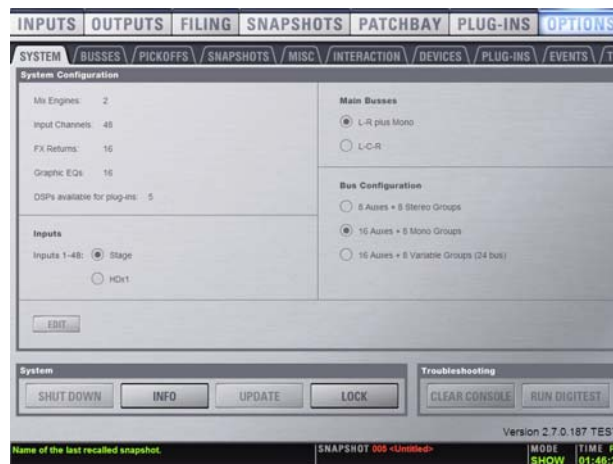

Options page (System tab for VENUE Mix Rack system shown)

See Chapter 6, “Options.”

# Chapter 5: Navigating and Selecting Channels

## Banking Input Channels and FX Returns

Many VENUE configurations utilize more physical inputs than input faders. To navigate to channels beyond the number of physical faders, the system provides channel *banking* controls.

The Bank switches navigate the display of input channels on the console.

- Input channel banks are accessed using the Bank A, B, C, and D switches, located to the left of the input faders.
- FX Returns are accessed using the FX Returns 1–8 and 9–16 switches, located between input faders 1–8 and 9–16.
- Input Channels and FX Returns can be put in Bank Safe mode, leaving them accessible regardless of the currently selected bank.

## Input Channel Banking

The Bank A, B, C and D switches affect all input faders.

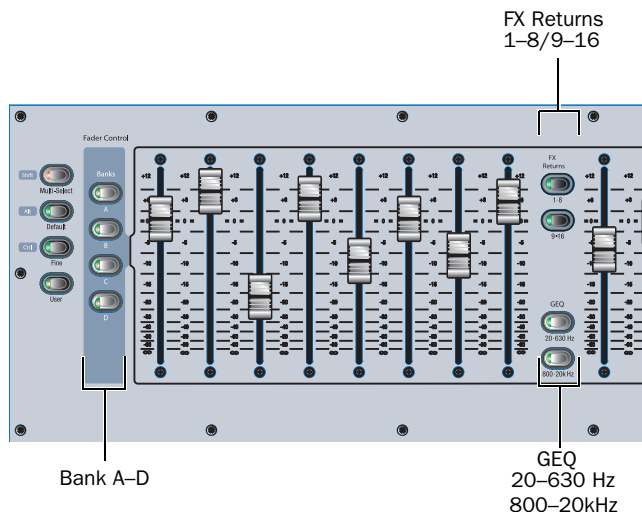

Input fader banking and assignment switches

### To bank Input Channels to the input faders:

- Press the appropriate Bank switch (A, B, C, or D).

## FX Returns Banking

The FX Returns switches bank FX Return channels 1–8 or 9–16 to input faders 1–8 or 9–16, respectively.

When only one FX Return bank is selected, other input faders remain banked on their current input channels. The Input bank button flashes to indicate which bank is currently assigned to these channels.

### To bank FX Returns:

- Press the FX Returns 1–8 or FX Returns 9–16 switch.

The FX Returns are banked to the input faders. Bank switch A, B, C or D flashes in order to indicate the current bank assignment of other input faders.

### To bank Input Channels while keeping FX Return channels on the input faders:

- Press any unlit Bank switch (A, B, C, D).

### To return input faders to Input Channel banking, do one of the following:

- Press the lit FX Returns switch (1–8 or 9–16).  
– or –
- Press the flashing Bank switch (A, B, C, D).

## Banking Graphic EQ Frequency Bands

When a built-in Graphic EQ is inserted on a currently targeted output or bus, its frequency bands can be selected using the Graphic EQ switches. This replaces Inputs 1–16 with either bank of EQ bands shown for each Graphic EQ bank switch (20–630 Hz, 800–20 kHz).

See Chapter 17, "EQ."

## Bank Safe Mode for Input Safe Switches

Bank Safe mode is a global Input Safe switch option available in the Option > Interaction page.

When Bank Safe mode is enabled, input channels and FX Returns can be Bank Safed using their Input Safe switches on the console, or on-screen. Bank Safed channels remain on the top fader layer of the console regardless of the current active bank, letting you temporarily “lock” the location of key input channels (such as a lead vocal, pulpit mics and similar) or FX returns to maintain immediate access while working with channels on a different layer.

For example, imagine 16 total input channels assigned to four banks (A through D) of an imaginary 4-fader console.

### Default channel layout for a 4-fader example

Bank	Fader 1	Fader 2	Fader 3	Fader 4
A	Ch 1	Ch 2	Ch 3	Ch 4
B	Ch 5	Ch 6	Ch 7	Ch 8
C	Ch 9	Ch 10	Ch 11	Ch 12
D	Ch 13	Ch 14	Ch 15	Ch 16

Channel 6 on Bank B is then Bank Safed. Selecting the various banks gives the following results:

### Channel layout with Bank Safe enabled on channel 6

Bank	Fader 1	Fader 2	Fader 3	Fader 4
A	Ch 1	Ch 6	Ch 3	Ch 4
B	Ch 5	Ch 6	Ch 7	Ch 8
C	Ch 9	Ch 6	Ch 11	Ch 12
D	Ch 13	Ch 6	Ch 15	Ch 16

Note that channels 2, 10, and 14 no longer appear on the console (though they remain accessible on-screen).

When an input channel or FX Return is removed from Bank Safe, the input channel that would normally appear in that fader location on the currently selected bank automatically re-appears.

Bank Safe is only available for Input channels (Output channels cannot be Bank Safed). Bank Safe status for all channels is stored with the Show file.

## Enabling and Using Bank Safe Mode

Bank Safe mode can be enabled on-screen from the Options > Interaction page.

### To enable Bank Safe mode on-screen:

- 1 Go to the Options > Interaction page.

- 2 In the Input Safe Switches section, click to enable Act as Bank Safes.



### Choices for Input Safe Switches in the Options > Interaction page

On-screen, the Safe switches at the top of each fader display the letter B to indicate Bank Safe mode. (See “On-Screen Display of Safe Switch Status” on page 47.)

You can also use the Event List to configure the Safe mode. For more information, see Chapter 22, “Events.”

## Using Bank Safe

### To Bank Safe channels:

- 1 Make sure you have enabled Bank Safe mode for the Input Safe switches.
- 2 Select one or more input channels.
- 3 Press the Safe switch in the Inputs area of the Selected Channel section.

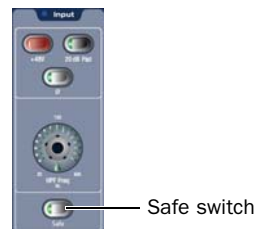

### Selected Channel, Input Safe switch

- 4 Press a Bank switch (A, B, C or D) to navigate to a different bank. Notice that the channel you Bank Safed remains; corresponding channels on other banks, though not present on the console, are still accessible on-screen.

## Toggling Bank Safe On-Screen

### To Bank Safe channels on-screen:

- 1 Make sure you have enabled Bank Safe mode for the Input Safe switches.



2 Click the channel Safe buttons on-screen, located at the top of each input channel strip.

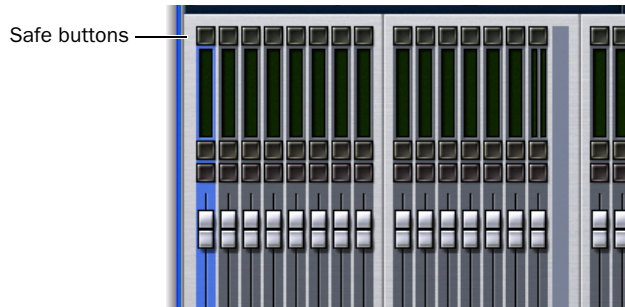

Toggle Bank Safe on-screen

### Safe Switch LED and Indication

The Safe LED at the top of each input strip flashes rapidly to indicate Bank Safe is enabled on that channel.

When a Bank Safed channel is targeted, the Safe switch in the Input section also flashes rapidly.

### On-Screen Display of Safe Switch Status

The channel Safe switches at the top of each strip of the on-screen faders light to indicate the current Safe status of each channel. When lit, that channel is enabled for the current Input Safe Switch mode (Automation, Solo, or Bank Safe). Each on-screen Safe switch indicates the current Input Safe Switch mode through use of a letter in the lit switch. For example, on-screen Safe switches show the letter B if Bank Safe mode is enabled and the channel is Bank Safed.



Bank Safe (two channels enabled)

### Special Cases Affecting Bank Safe

Special rules and conditions are automatically applied to Bank Safe status whenever you do the following:

- Bank to GEQ faders
- Move channels or shuffle channel layout
- Change the system configuration

### GEQ Fader Mode

Selecting a GEQ fader bank overrides Bank Safe. Returning to any fader bank (thus exiting GEQ Fader mode) restores the previous input layout, including Bank Safe status. This applies to channels 1–16 on VENUE Profile.

### Moving or Shuffling Channels

Bank Safed channels shuffle accordingly when any operation is performed that results in a re-ordering of input channels, including the following:

- Inserting or Removing a Blank Strip
- Moving a strip

- Splitting a stereo strip(s)
- Opening a Show file that was saved on a VENUE system that used a different console.

### Priority for Replacing Bank Safe Assignments

The following rules apply to resolve any potential collisions between Bank Safed channel assignments:

- Input channels always replace any FX Returns that are Bank Safed in that corresponding fader position.
- A lower numbered input channel always replaces a higher numbered input channel in that corresponding fader position.

In addition:

**Make Stereo** The Bank Safe status of the left channel is inherited by the newly created stereo channel.

**Split Stereo** The Bank Safe status of the stereo channel is applied to each of the newly created mono channels.

### Bank Safe and Backup Personality

Channel Bank Safe remains in effect and available if Bank Safe mode is engaged. This ensures consistent and uninterrupted fader control during the rare case of a system reset.

Modified Bank Safe functionality is available while the Backup Personality is active. Specifically:

- Input Channel layout does not unexpectedly change when the backup personality is activated or de-activated.
- Input Channel Safe LEDs automatically revert to displaying Bank Safe status.
- The Safe switch in the Selected Channel Inputs section flashes rapidly if one or more channels are Bank Safed.
- Pressing the flashing Inputs Safe switch clears the Bank Safe status of *all safed channels*. Bank Safe status is not restored upon resuming normal operation, nor can it be re-enabled for any channel while the Backup Personality is active.

You cannot change the current Input Safe Switch mode while the Backup Personality is active.

### After Resuming Normal Operation

Any changes to Bank Safe status made while the Backup Personality is active will persist when normal operation resumes. You can continue working uninterrupted knowing Bank Safe status will not be reset to its state prior to when the Backup Personality was activated.

## Banking the Output Section

Outputs are controlled using the Output faders and Encoders.

The Mains fader provides constant access to the house output (Mains) bus, and does not follow Output fader banking.

**To bank the Output faders to control Auxes, PQs, Matrix mixers, Groups (or Var Groups), or VCAs:**

- Press the corresponding switch in the Output Faders section.

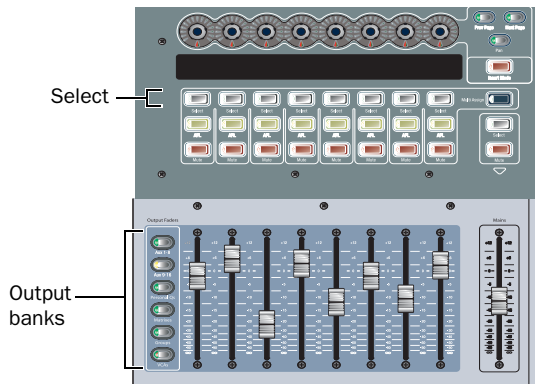

Bank switches for Output channels

## Selecting and Targeting Channels

Each VENUE channel strip has a channel Select switch. The Select switch targets that channel for routing or processing assignment. When a single channel is selected it becomes the targeted channel, which can be adjusted from the console or on-screen. Channels can also be selected by clicking their fader strips on-screen.

**To select a channel, do one of the following:**

- Press the Select switch on the console channel strip.
  - or –
- Click anywhere in the on-screen channel fader strip, except on the fader, mute, solo or safe buttons.

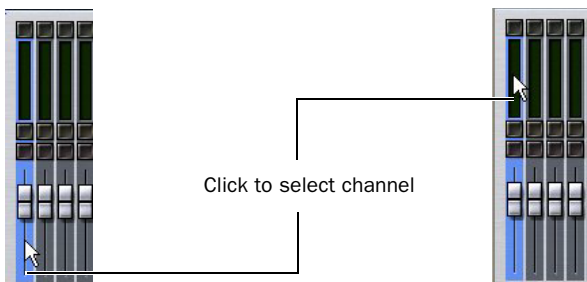

Clicking on-screen to select a channel

## Multi-Select (Shift)

Multi-Select lets you select multiple channels in order to apply an action to them in one step.

**To select multiple channels from the console:**

- 1 Press and hold the Multi-Select switch (located next to the input Bank switches). The switch flashes to indicate Multi-Select mode.
- 2 Press Select on each channel you want to include in the selection.
- 3 Release the Multi-Select switch.
- 4 Perform a routing assignment or other function (for example, press a Bus Assign switch on one of the included channels). The operation is applied to all selected channels.

 You can use the Shift key on the keyboard or the Multi-Select (Shift) switch to select multiple channels.

**To exit Multi-Select mode, do one of the following:**

- Press Cancel.
  - or –
- Press the Select switch on a channel that is currently not selected.

**To select multiple channels on-screen:**

- Press and hold the Multi-Select switch (or hold Shift on the keyboard) and click the fader strips on-screen.

**To select an 8-channel bank on-screen:**

- Click the bank name below the on-screen fader strips. Shift-click to select additional banks or channels.

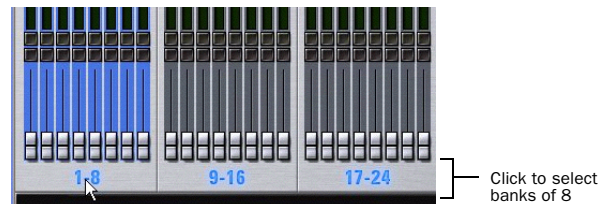

Clicking a bank display to select multiple channels on-screen

**To select all input channels or all output channels on-screen:**

- Double-click any bank name below the on-screen fader strips in the Input or Outputs screen.

**To remove a channel from a selection:**

- Control-click (or Fine-click) a highlighted channel.

 See "Screen Controls" on page 50 for additional on-screen features.

## Multi-Assign

The Multi-Assign switch in the Output section is used to route multiple channels to the selected output bus.

### To assign one or more channels to an Aux, Group, or VCA:

**1** Press one of the following switches in the Output Fader assignment section:

- Aux 1–8
- Aux 9–16
- Groups
- VCAs

**2** Press the Multi-Assign switch near the Output encoders. The flashing Multi-Assign switch and the banner display at the lower left of the screen indicate Multi-Assign mode is enabled.

**3** Press the Select switches on the channels you want to assign to the Aux, Group, or VCA.

**4** Select any other output to confirm the previous assignment and proceed to assigning channels to the new selection. To confirm the assignment and exit Multi-Assign mode, press the flashing Multi-Assign switch.

**5** To cancel the assignment do either of the following:

- Press the Cancel switch (in the Mute Groups/Function section), or press the ESC key on your keyboard.
- or –
- Click Cancel in the on-screen Multi-Assign dialog box.

 See Chapter 8, “Outputs and Output Routing.”

## Type Text Search

Type Text search lets you use the keyboard for fast navigation to a channel, or to quickly go to a specific snapshot or event. You can enter the first characters of a channel name or the absolute channel number to target that channel on the ACS. (See also “Selecting and Targeting Channels” on page 48.)

### To search for and select a channel by name:

**1** Go to the Inputs, Outputs, or Patchbay page.

**2** Type the first few letters, channel number, or full name of the channel. For example, type “s” to go to the first channel beginning with the letter s (such as Snare).

**3** Press the Tab key to cycle through and select any other channels beginning with that letter (such as *Snare Top*, *Snare Bottom*, or *Strings*).

### To search for and select a list item by name (or number):

**1** Go to the Snapshots, Events or Filing page. Or, click to open any Presets window (built-in Dynamics or EQ presets, Input Channel presets, or Scope Sets).

**2** Type the first few letters or number of the desired item.

**3** Press the Tab key to cycle through and select any other items that begin with the same letters.

## Channel Numbers and Names

VENUE SC48 channel numbers are “absolute” channel numbers. Renaming changes the displayed name associated with each channel, but the absolute channel number remains fixed.

### To search for and select a channel by absolute number:

■ Type a number on the keyboard to select the corresponding channel.

 *Type Text search can also be used to select snapshots and events.*

---

## Targeting Plug-In Inserts

Selecting a single channel targets that channel in the ACS. This lets you enable Inserts Mode to use the Output encoders to adjust plug-ins inserted on that channel.

 For more information, see See Chapter 18, “Plug-Ins.”

## Screen Controls

### Adjusting On-Screen Faders

You can move on-screen faders independently or in ganged fashion.

**To adjust a single fader on-screen, do one of the following:**

- Drag a fader in the on-screen channel strip section at the bottom of the screen.
  - or –
- Select a channel and move its fader in the on-screen selected channel controls.

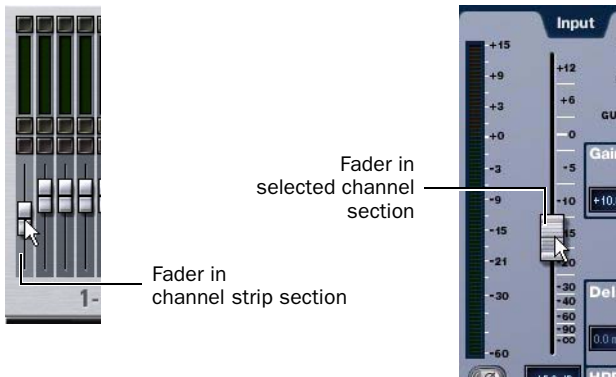

*Dragging a fader on-screen*

**To move multiple faders on-screen in ganged fashion:**

- 1 Select multiple channels on-screen by Shift-clicking.
- 2 Move the fader on one of the selected channels.

The faders on the selected channels will move in ganged fashion. Any offset between the faders is maintained until at least one of the faders is minimized (moved to  $-\infty$ ) or maximized (set to  $+12$  dB).

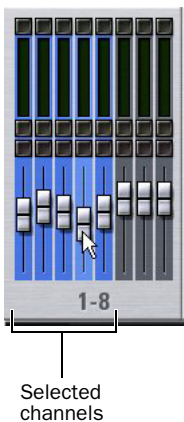

*Dragging multiple faders on-screen*

### Adjusting On-Screen Encoders

You can adjust on-screen rotary encoders by dragging directly over the on-screen knob.

**To adjust an on-screen rotary encoder:**

- 1 Click on the knob so that it is highlighted.
- 2 Drag up to turn the encoder clockwise; drag down to turn the encoder counter-clockwise.



*Dragging over an encoder on-screen*

### Adjusting Values On-Screen

In addition to typing numeric values in text boxes, you can adjust parameter values and numeric option settings on-screen by dragging directly over the corresponding text box.

**To adjust a value on-screen by dragging:**

- 1 Click in the text box to select the value.
- 2 Drag up to increase the value; drag down to decrease the value.



*Adjusting a parameter value by dragging over its text box*



## Screen Shortcuts

The on-screen Fader display provides the following right-click shortcuts.

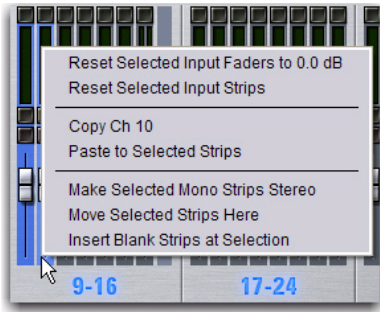

Right-clicking a fader on-screen

💡 See also “Fader and Encoder Shortcuts” on page 54.

### Reset Fader to 0

Resets the fader position to zero.

### Reset Selected Input Strips

Resets every parameter on the selected channel(s) to default settings.

### Copy and Paste Channel

Channel settings can be copied in their entirety from one channel and pasted to one or more channels from the console or on-screen.

💡 You can also store and load settings as Input Channel Presets. For information, see “Input Channel Presets” on page 54.

By default, Function switches 3 and 4 (F3 and F4) are programmed for Copy and Paste, respectively.

💡 Using the Events List, Copy and Paste can be assigned to any trigger. For more information, see Chapter 22, “Events.”

#### To copy and paste channel settings from the console:

- 1 Press the Select switch on the channel you want to copy.
- 2 Press F3 to copy.
- 3 Press the Select switch on one or more destination channels (the channel or channels to which you want to paste the copied settings).
- 4 Press F4 to paste. The status displays shows a message confirming the Paste operation.

#### To copy and paste channel settings on-screen:

- 1 Do one of the following:
  - Right-click on a channel fader in the fader display across the lower half of the screen and choose Copy.
  - or –
  - Right-click within the upper channel display and choose Copy.



Copying channel settings

💡 You do not need to select the channel before copying its settings on-screen.

- 2 Select one or more destination channels. You can only paste to selected channels.

- 3 Right-click on the lower fader strip on-screen, or on any non-control area of the destination channel, and choose Paste to Selected Strip(s). The status displays shows a message confirming the Paste operation.

### Parameters and Channel Types

Input channels can only be copied or pasted to other Input channels. Output channels can only be copied or pasted to other channels of the same type (such as Aux, Group, PQ, Matrix). When pasting channel settings:

- Settings common to the source and destination channel are always pasted.
- Copied settings with no corresponding parameter in the destination channel are ignored.
- Settings in the destination channel with no corresponding parameters are left unchanged.

### Copying and Pasting Mono and Stereo Channel Settings

You can copy a mono channel and paste its settings to one or more stereo channels. Mono settings are applied equally to the left and right channels of the stereo destination. The stereo destination channel retains its current balance and width settings.

You can also copy a stereo channel and paste its settings to one or more mono channels. The left channel settings of the stereo source are applied to the mono channel(s). The mono destination channel retains its current pan setting.

## Settings Excluded from Copy and Paste

**Input Channels** The following Input channel parameters are not copied or pasted (the current settings of the destination channels are retained):

- Patchbay assignments, including Direct Outs
- Channel Name
- Hardware and software insert (plug-ins) assignments and in/out state.

**Output Channels** The following Output channel parameters are not copied or pasted (the current settings of the destination channels are retained):

- Patchbay assignments, including Direct Outs
- Channel Name
- Hardware and software insert (plug-in) assignments and in/out status
- GEQ settings
- Output membership (the assignment of channels to an Aux, Group, VCA, Matrix or PQ).

💡 *To copy GEQ settings, use the copy/paste GEQ shortcut or use GEQ Presets. Use the Replace with Mix (members) From command to replace output membership for an Aux, Group, VCA, Matrix or PQ.*

## Make Selected Mono Strips Stereo/Make Selected Stereo Strip Mono

Combines two selected mono channels into a single stereo channel, or splits a selected stereo channel into two mono channels. VENUE must be in Config mode to change the stereo status of a channel.

## Move Selected Strip

Moves a selected strip from its current position to a new location. When you move a channel strip, other channels are moved (and renumbered) lower or higher to accommodate the moved channel.

VENUE must be in Config mode to move channel strips.

### To move a fader strip:

- 1 Put the system in Config mode.
- 2 Select the channel you want to move.
- 3 On-screen, right-click on the destination strip (where you want to move the selected channel).
- 4 Choose Move Selected Strip Here from the pop-up menu.

⚠️ *Snapshots cannot store and recall custom console channel position.*

## Insert Blank Strip

The Insert Blank Strip command lets you insert one or more blank (or “spacer”) strips anywhere among your input channels. In addition, blank strips are automatically inserted when you use the Make Stereo command to convert two mono input channels into a single stereo channel, preserving the channel layout.

Blank strips are strictly placeholders (no audio or any type or processing take place), and therefore consume no additional processing overhead or DSP resources.

Use blank strips to create obvious divisions between groups of instruments, or to optimize the bank placement of inputs on the console.

Blank strips are saved and loaded as part of the Show file. Blank strips remain available during Backup Personality mode.

## Blank Strips on the Console

A blank strip has no LCD channel name display, and all of its physical controls and indicators are inactive. Blank strip faders are set to the bottom (–inf) position and always revert to this position if moved.

## Blank Strips On-Screen

Blank strips appear as a simple gray strip with no fader, buttons or meter. A blank strip can be right-clicked to reveal its context menu.

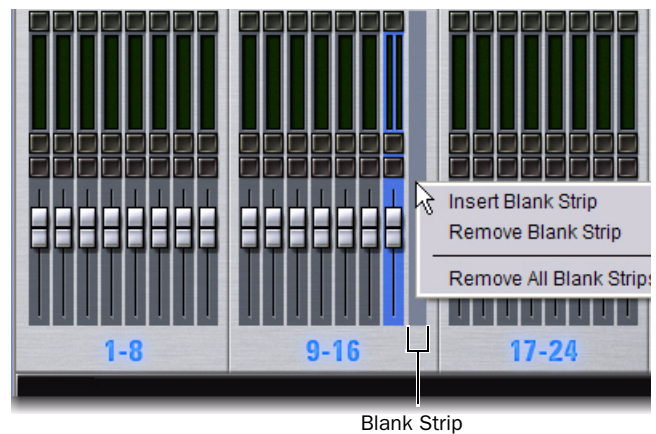

**Blank strip in position 16, Right-click menu shown**

## Adding Blank Strips

Blank strips can be inserted manually, and are also created automatically when you use the Make Stereo command.

### Manually Inserting Blank Strips

#### To manually add a blank strip:

- 1 Enable Config mode.
- 2 Right-click an input channel strip at the location where you want to insert a blank strip and choose Insert Blank Strip. For example, if you want to have a blank strip at channel strip 16, right-click on channel 16.

You can also select a blank strip and choose Insert Blank Strip to insert multiple blank strips.

All channels to the right of the insertion point (including the right-clicked channel) are shuffled one position to the right.



*This command will be unavailable if the combined number of input channel strips plus blank strips equals or exceeds 96. For more information, see “Limits and Guidelines for Blank Strips” on page 53.*

#### To insert multiple blank strips:

- 1 Put the system into Config mode.
- 2 Create a multi-selection of channels.
- 3 Right-click on one of the selected channels and choose Insert Blank Strips at Selection.

A blank strip is inserted in place of each selected channel strip, shifting all channels accordingly and maintaining the multi-selection.

### Automatically Inserting Blank Strips using Make Stereo

VENUE automatically creates blank strips when you use the Make Stereo command in order to preserve the current channel layout. Similarly, blank strips may be automatically removed when you use the Split Stereo command to revert a stereo strip to its two contributing mono channels.

**Make Stereo** A blank strip is automatically inserted at the location previously occupied by the right-side channel of the newly-formed stereo pair. There is no shuffling of the remaining input channels as a result of this operation.

**Split Stereo** The behavior when splitting a stereo strip into two mono strips is as follows:

- If a blank strip is located immediately adjacent to the (previously) stereo channel, the right channel of the stereo pair occupies this position and the blank strip is automatically removed. No other channels shuffle.
- If no blank strip is located immediately adjacent to the (previously) stereo channel, all channels to the right of the split point shuffle one position to the right and the right channel of the stereo pair is inserted.

### Removing Blank Strips

Blank strips can be removed manually.

#### Manually Removing Blank Strips

##### To remove a blank strip:

- Right-click the blank strip you wish to remove and choose Remove Blank Strip.

##### To remove all blank strips:

- Right-click any blank strip and choose Remove All Blank Strips.

Blank strips are removed and all channels to the right are shuffled one position to the left.

### Limits and Guidelines for Blank Strips

The maximum number of fader strips is 96. These 96 positions can be comprised of any combination of mono or stereo input channels, as well as blank strips. (FX Returns are considered separate and are not included in this count.)

The maximum number of blank strips that can be used varies depending on the current system configuration and the number of stereo channels used in the configuration. This number can be calculated as:

$$(96 - \text{the number of input channels in System Configuration}) + \text{Number of stereo channels}$$

For example:

- A 96 channel configuration with 96 mono channels can have 0 blank strips.
- A 48 channel configuration with 48 mono channels can have 48 blank strips
- A 48 channel configuration with 4 stereo channels can have 52 blank strips ( $52 = 96 - 48 + 4$ )

## Fader and Encoder Shortcuts

The on-screen channel faders and encoders provide the following right-click shortcuts to reset individual parameters and channel strips.



Right-clicking channel strip controls on-screen

### Reset Parameter

To reset an on-screen fader or encoder to its default value, do one of the following:

- Right-click the control and choose Reset.
  - Or –
- Alt-click the control.

### Reset Channel

To reset an entire channel strip to its default settings:

- Right-click the on-screen channel fader and choose Reset Strip.

---

## Input Channel Presets

Input channel configuration (input name, gain, fader levels, send levels and bus routing) can be stored and recalled as Input Channel Presets. Input Channel Presets can be previewed, recalled and transferred just like other VENUE preset files, letting you quickly configure channels from among a library of favorite setups.

When an Input Channel is stored or recalled as a preset, all parameters are affected except the following:

- Patchbay assignments, including Direct Outs
- Hardware and software insert (plug-in) assignments and in/out state.

**⚠** *Selecting a channel preset automatically loads the saved settings into the selected channel. Depending on the stored settings this may dramatically change channel level and signal routing. Use caution when previewing Input Channel Presets with a live source.*

To store a channel as an Input Channel Preset:

- Configure an Input Channel as desired.
- Click the Channel Presets icon (the folder icon located to the right of the Channel Routing indicator and +/- buttons).



Channel Presets icon in the Inputs page

- Specify a folder in which to save the preset, if the currently selected folder is not appropriate, by clicking the Folder selector and selecting a different folder.

- Click New.

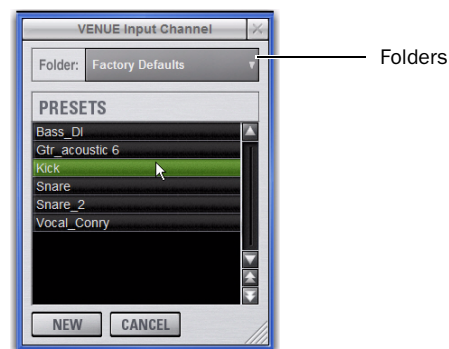

Input Channel Presets window

To preview and recall a saved Channel Preset:

- Navigate to the Inputs page for the desired channel. Channel Presets can only be loaded into a single channel at a time.
- Click the Channel Presets icon.
- If necessary, click the Folders icon and select the appropriate Channel Presets folder from the pop-up menu.
- Do any of the following:
  - To preview an existing Channel Preset, click its name in the Channel Presets window.
  - To load the currently selected Channel Preset, press Enter or click the Close box (X) in the Channel Presets window title bar.
  - To cancel without changing settings, click Cancel.

To rename, duplicate, overwrite or delete a Channel Preset:

- Right-click the preset name in the Channel Preset window and choose Rename, Duplicate, Delete, or Overwrite.

## Channel Compatibility and Input Channel Presets

The following describe how different types of channel data is handled when storing or loading Input Channel Presets.

### Channel Names and Presets

New presets automatically inherit the current Input Channel Name, or you can give them a custom name in the Presets window. The default channel number (such as “Ch 16”) is used for the preset name if the channel has an empty (null) name.

### Loading Mono and Stereo Channel Presets

You can load mono Channel Presets into stereo channels, and stereo Channel Presets into mono channels.

**Loading Mono to Stereo** Mono settings are applied equally to the left and right channels of the stereo destination. The stereo destination channel retains its current balance and width settings.

**Loading Stereo to Mono** When loading a stereo preset into a mono Input Channel, the left channel settings in the stereo preset are applied to the mono destination channel. The mono destination channel retains its current pan setting.

### Channel Compatibility

When storing and loading Input Channel presets, remember the following:

- ◆ Group bus assignments are not applied if the settings in the preset do not match the current console Bus Configuration
- ◆ Aux send level or pan settings for individual aux pairs are not applied if the stored stereo link/unlink state does not match the current link/unlink state. For example, assume the stored preset has Aux 1–2 linked, but the current console configuration has these Auxes unlinked. When the preset is recalled Aux 1 and Aux 2 will retain their current settings (they will not be updated), while all other Auxes are updated to the preset settings.

### Transferring Input Channel Presets

Input Channel Presets are available as Built-In Presets in the Transfer tab of the Filing page. This lets you transfer your Channel Presets to a USB key disk or other storage device for backup and transfer to other systems.

Input Channel Presets are supported on all systems running VENUE software 2.5 or later, including the Standalone software.

 *For more information, see Chapter 20, “Shows and File Management.”*



# Chapter 6: Options

The Options page provides several tabs. Of these, the System and Devices tabs are where most system configuration settings and options are enabled and customized:

- The System screen provides the primary tools by which you configure mixing, routing, and processing options.
- The Devices screen provides status, diagnostics, and options for hardware components.

This chapter shows you how to manage the most important System and Devices settings, and describes the settings available in other Options screens.

## Overview of Options

The Options page provides the following tabs:

- “System” on page 57
- “Busses” on page 60
- “Pickoffs” on page 61
- “Snapshots” on page 62
- “Misc” on page 63
- “Interaction” on page 64
- “Devices” on page 59
- Chapter 22, “Events”
- Plug-Ins (see “Installing and Authorizing Plug-Ins” on page 151)

**To display the Options page, do one of the following:**

- Press the Options switch in the View Mode section.  
– or –
- Click the Options tab on-screen.

**To display different tabs of the Options page, do one of the following:**

- Press the Options switch repeatedly to cycle through available tabs.  
– or –

Click the desired tab at the top of the Options page (System, Busses, Pickoffs, Snapshots, Misc, Interaction, Devices, Events or Plug-Ins).

 *The Plug-Ins tab is not available in the Standalone software.*

---

## System

### (System Configuration)

The System page lets you allocate DSP resources used for routing and processing, configure Mains and Aux/Group busses, reset the system (clear console), and quit (shut down VENUE).

**To access the System Config page:**

- Go to the Options page and click the System tab.

### Basics of Editing System Settings

Settings available in the System screen can only be edited while in Config mode.

 *Changing the system configuration will restart the system software and may interrupt audio.*

In Config mode, the Edit button becomes available to let you change settings. When a System Config setting is changed, the Apply button becomes available at the right of the screen to let you confirm and apply changes.



*System Configuration tab of the Options page*

In Show mode, the Edit button is unavailable. This protects these settings from being changed during a performance (since changes to these settings can interrupt audio).

**To change a System Config option:**

- 1 Put the system in Config mode.
- 2 Go to the Options page and click the System tab.
- 3 Click Edit.
- 4 Change a System Config, Main Bus, Inputs or Bus Configuration option.
- 5 Click Apply to confirm and apply your new settings.



## System Configuration Settings

The System Configuration section shows the current allocation of system resources.

In Show mode, the System Config area is display-only. In Config mode, you can edit the system configuration to allocate resources for mixing and processing.

### To change a System Configuration setting:

- 1 Put the system in Config mode.
- 2 Click the Edit button on-screen.
- 3 Choose a new setting for Input Channels or Graphic EQs.
- 4 Click Apply to confirm the settings.

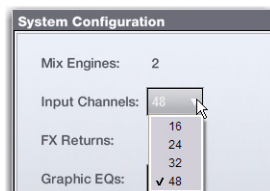

Designating the number of Input Channels

## Mix Engines

The Mix Engine setting is determined by the number of DSP Engine Cards detected in the system rack (Mix Rack, or FOH Rack). Mix Rack comes supplied with two Mix Engines and can be expanded with one additional Mix Engine (total of 3, maximum). FOH Rack comes with three and can be expanded to include up to 5 Mix Engine cards.

## Channels

Choose the total number of Input Channels you need. This number represents mono input processing channels (not hardware input jacks); each stereo channel uses two mono channels.

- You can configure a VENUE Mix Rack system to use 16, 24, 32, 48, or 64 input processing channels.
- You can configure a VENUE Profile system to use 16, 24, 32, 48, 64, 80, or 96 input processing channels (higher settings require two Stage Racks).

Choosing a lower number of Input Channels leaves more DSP for plug-ins, while choosing a higher number reduces the amount of DSP available for plug-ins.

 On VENUE Mix Rack systems, choosing the highest number of input processing channels (64) lets you use “extra” input processing channels for advanced monitor mixing workflows. For more information, see “Multiple Input and Output Assignments in the Patchbay” on page 112.

## FX Returns

Choose the number of FX Return channels you need (8 or 16).

## Graphic EQs

Choose the number of Graphic EQs needed for output processing. You can choose to have 0, 8, 16, or 24 Graphic EQs. Choosing a lower number leaves more DSP for plug-ins.

## DSPs Available for Plug-Ins

The amount of DSP available for plug-ins depends on the number of Mix Engine cards installed in your FOH or Mix Rack, and the current system settings for Input Channels, FX Returns, and GEQs. To increase the amount of DSP available for plug-ins, reduce the number of Input Channels or Graphic EQs, or add additional Mix Engine cards.

## Main Bus Settings

The Main Bus Settings let you configure the Main mix bus. See “Configuring Aux, Group, and Variable Group Busses” on page 80.



Main Busses options in the System page

### L-R plus Mono

This default setting provides a stereo bus, plus one mono bus.

### L-C-R

This setting enables L-C-R mode, which lets you mix in “3-across-the-front” mode.

 Changing the Main Bus mode will restart the system software and may interrupt audio.

### To change the Main Bus configuration:

- 1 Put the system in Config mode.
- 2 Go to the Options page and click the System tab.
- 3 Click Edit.
- 4 Click to choose a Main Bus mode.
- 5 Click Apply; the system restarts.



## Bus Configuration Settings

The Bus Configuration Settings let you choose the Aux and Group/Var Group busses configuration. See “Configuring Aux, Group, and Variable Group Busses” on page 80.



Bus configuration settings in the System page

### To change the Aux/Group Bus Configuration:

- 1 Put the system in Config mode.
- 2 Click the Edit button on-screen.
- 3 Click to select a Bus Configuration option.
- 4 Click Apply; the system restarts.

## Devices

The Devices page lets you view system connections, troubleshoot hardware and reset VENUE system components.

### To display the Devices tab:

- Click Options > Devices.

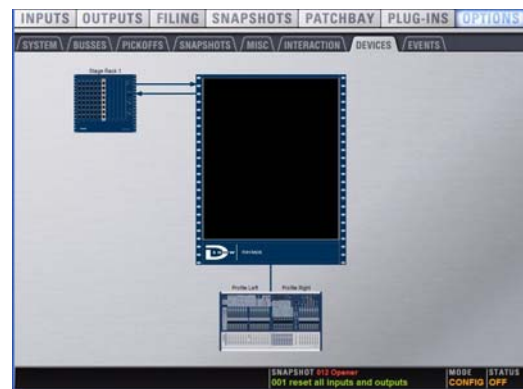

Devices tab of the Options page

You can use this page to view component status after diagnostics or troubleshooting.

### To reset VENUE system hardware components:

- 1 Put the system in Config mode.
- 2 Go to the Options page and click the Devices tab.
- 3 Right-click any of the following hardware components:
  - Console sections
  - Racks (Mix Rack, FOH Rack or Stage Rack)
- 4 Choose Reset.

## Simulating a VENUE Configuration with the Standalone Software

With the VENUE Standalone software, you can use the Devices page to simulate a VENUE system of any size for purposes of preparing shows and training. See “Simulating a VENUE Configuration” on page 224.

## Other Options and Settings

### Busses

The Busses page lets you customize characteristics for the Aux, Solo, Matrix, and Main busses.



Busses tab of the Options page

### Auxiliaries and Variable Groups

These options let you designate bus link status, pick off source, and stereo pan behavior for Auxiliaries (Aux Send busses).

**Links** When enabled, this option links the corresponding busses into bus pairs. Control changes affect both mono Aux busses, and the Follows Channel Pan option becomes available.

**Pickoff** These options let you designate the pre-fader pickoff point feeding each bus. Choices include pre-EQ, pre-mute, and pre-fader (post-mute).

**Follows Channel Pan** Each channel can be panned independently within each linked bus pair, or configured to follow the channel pan by enabling the Follows Channel Pan option.

#### To change the Aux bus configuration:

- 1 Put the system in Config mode.
- 2 Go to the Options page and click the Busses tab.
- 3 Click Edit.
- 4 Configure the following settings:
  - To link two mono Aux busses into a bus pair, select the Link option for the corresponding pair.
  - Specify the panning for channels routed to Aux bus pairs with the Follows Channel Pan option.
  - Click to select the pickoff point for each bus (Pre-EQ, Pre-Mute, or Pre-Fader).

5 Click Apply to reconfigure the system, or click Cancel to exit without changing system settings.

For more information, see Chapter 10, “Aux Sends and Variable Groups.”

### Solo and Monitor Operations

These settings customize Solo and Monitor (cue) bus mode and operation.



Solo controls in the Options > Busses page

**Type** Solo mode choices include PFL (Pre-Fader Listen), Stereo AFL (After-Fader Listen), and Solo-In-Place.

**Level Trim** Mirrors the functionality of the Solo/PFL level control on the control surface.

**Monitoring** Sets the level of the Headphone and Monitor outputs.

**Delay** Sets a delay for time-aligning headphones and near-field monitors to the house system.

**Auxes/Var Groups Follow AFL** Puts the controls for an Aux Send or Variable Group Send on the input channel encoders whenever the AFL switch is pressed on that Aux or Var Group bus.

**AFL Follows Auxes/Var Groups** Soloes the Aux (or Variable Group) bus that is currently assigned to input encoders.

**Auto Cancel** Soloing a channel strip automatically takes any currently soloed channels out of solo.

**Input Priority** Makes soloed inputs temporarily replace soloed output busses on the AFL/PFL bus.

**Mix to Monitors** Mirrors the functionality of the Mix to Monitors switch on the control surface.

**Cue on Mains Fader** Puts control of the Monitor bus level to the Mains fader.

### To configure Solo settings on-screen:

- 1 Go to the Options page and click the Busses tab.
- 2 Configure settings as needed:

### To adjust Monitor Bus Delay, do one of the following:

- Adjust the Delay encoder on-screen.
- Click the Delay value shown on-screen, and manually enter a new value.

### To toggle Delay on or off:

- Click to toggle the Delay In switch on-screen.

 *Delay settings are retained when toggled off or on.*

 *For more information, see “Solo and Monitor Busses” on page 119*

## Matrixes

The Matrixes section lets you link and unlink Matrix to form stereo Matrix busses.

**Links** When enabled, these options link corresponding mono Matrix busses into stereo-linked pairs. Control changes then affect both mono Matrix busses.

 *For more information on these features see Chapter 11, “Matrix and Personal Q Mixers.”*

## Panning/Center Divergence

The Panning section provides control over center channel divergence when the Main Bus is set to L–C–R mode. See “Main Bus Center Divergence Options” on page 85.

### To set Center Divergence:

- Enter a value or drag in the Center Divergence text box and press Enter.

## Stereo Group Panning Operation

The Stereo Group Panning Operation options provide different levels of flexibility for how channels can be routed to Groups.

### To change Stereo Group Panning Operation:

- 1 Put the system in Config mode.
- 2 Click to select Simple or Expert mode.

 *For more information on these options, see “Simple and Expert Operational Modes” on page 93.*

## Pickoffs

The Pickoffs page lets you control the bus pickoff point on input strips, as well as specify source and insert points for output busses. The Pickoffs page also provides master control for Delay Compensation.

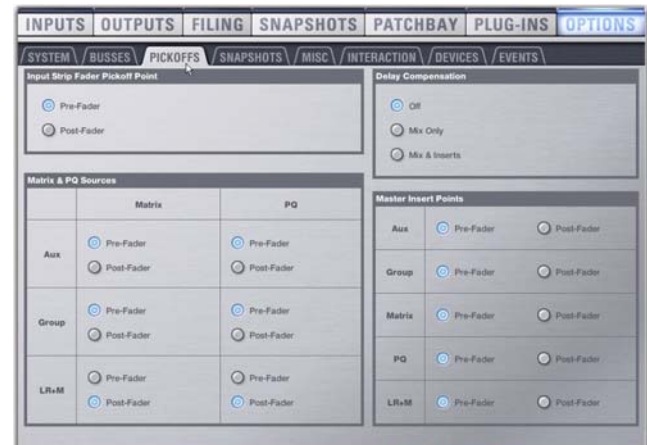

*Pickoffs tab of the Options page*

Pickoff options are explained throughout this guide where relevant.

## Settings for Delay Compensation

The Options > Pickoffs page provides three settings for Delay Compensation: Off, Mix Only, and Mix and Inserts.

**Off** No Delay Compensation is applied.

**Mix Only** VENUE automatically compensates for delays incurred by the use of Groups routed to the Mains busses.

**Mix and Inserts** VENUE automatically compensates for delays incurred by the use of plug-ins as well as those incurred by the use of Groups routed to the Mains busses.

## Snapshots

The Snapshots page provides several snapshot preference settings to optimize Snapshot operation.

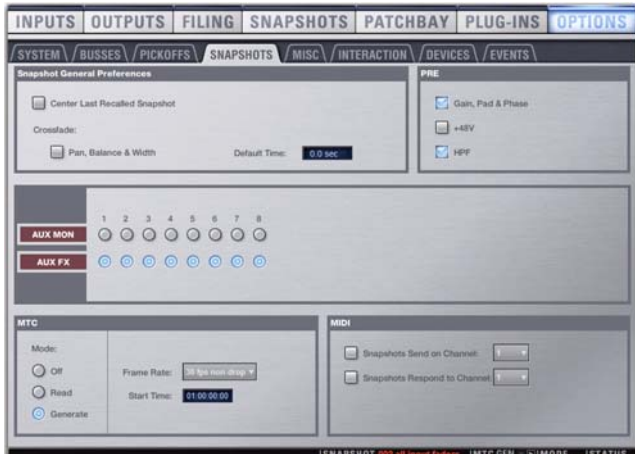

Snapshots tab of the Options page

### Snapshot General Preferences

The following settings are available in the Snapshots page.

**Center Last Recalled Snapshot** Manages the display of the Snapshots list so that the last recalled snapshot is always centered vertically, letting you maintain display of adjacent snapshots in the list.

#### Crossfade

All snapshots provide a Crossfade setting that determines how long scoped faders will crossfade to the stored values in that snapshot when it is recalled. The Options > Snapshots page provides Snapshot General Preference settings for optimizing crossfades between snapshots.

**Default Time** Defines a (fader) Crossfade time to apply to all new snapshots.

**Pan, Balance & Width** Enables pan, balance and width on scoped channels to crossfade.

 For more information, see Chapter 21, “Snapshots.”

#### PRE

The options in the PRE section let you specify which parameters are recalled with Snapshots whose scope includes Pre settings. Click to toggle whether recalled Input snapshot data includes the following:

- Gain, Pad, and Phase
- +48V (phantom power)
- HPF

 Delay is stored as a unique (discrete) data type for each channel.

## Aux Mon and Aux FX

These settings let you classify individual Aux Sends (including linked bus pairs) as monitor sends (“Mon”) or as effects sends (“FX”), which lets you scope each type separately from the Snapshots page.

This option is for organizing Aux Sends and Var Group Sends for snapshot control only, and does not directly affect Aux bus operation.

### MTC (MIDI Time Code)

The MIDI Time Code options let you control MTC operational modes, frame rate, and Start Time.

**Modes** Available MTC modes are MTC Off, MTC Read (slave), and MTC Generate (master).

**Frame Rate** This option sets the frame rate that is used when generating MTC.

**Start Time** This option sets the start time that is used when generating MTC.

### MIDI

Designates the channel on which snapshots send or receive MIDI Bank Select and Program Change information.

 See Chapter 23, “Synchronization.”

**Snapshots Send on Channel** This option sets snapshots to send Bank Select and Program Change commands on a selected MIDI channel. This provides a quick and easy way to send a MIDI command every time a snapshot is fired, without having to embed a MIDI program change within each snapshot.

Snapshot Send on Channel does not need to be turned on in order to send other types of MIDI data that *are* embedded in snapshots, such as note on/off or MMC.

**Snapshots Respond to Channel** This option sets snapshots to respond to incoming Bank Select and Program Change commands on the selected MIDI channel.

**MIDI Snapshot Output Safe** Safes (shuts off) VENUE MIDI output when snapshots are recalled. This does not affect sending of Bank Select and Program Change commands with the Snapshots Send on Channel option.

## Misc

The Miscellaneous page provides utility and other settings.



Misc tab of the Options page

### Oscillator

Lets you choose the tone, frequency, and level for the built-in oscillator, and route it to an available output.

**Signal** Lets you choose the type of oscillator tone to use. Choices include sine, variable sine, and noise.

**Frequency** Lets you set the oscillator frequency.

**Route** Enables Route Osc to Selected mode, to assign the oscillator signal to the currently selected output channel(s).

### 2-Track

Lets you set the level and input source for the 2-Track analog and digital inputs, and route them to the desired outputs.

**2-Track Level** Lets you activate 2-Track input and set 2-Track input level.

**2-Track Input** Selects which 2-Track input (analog, or digital) is fed to the monitors and output busses.

**Route** Enables Route 2-Track to Selected mode, to assign the 2-Track signal to the currently selected output channel(s).

### Talkback

**Talkback Level** Lets you activate Talkback and set Talkback input level.

**Talkback Dim Level** Sets the dim level, which is the amount of attenuation applied to the mix on the output bus when Talkback is activated.

**Route** Enables Route Talkback to Selected mode, to assign the Talkback signal to the currently selected output channel(s).

## Routing Osc, 2-Track and Talkback

Use the Patchbay to assign the Oscillator, 2-Track inputs, or Talkback input to an Input or FX Return fader.

You can use the on-screen Route buttons to route oscillator, 2-track and talkback signals to outputs.

### To route the Oscillator, 2-Track, or Talkback outputs on-screen:

**1** In the Options > Misc page, click the Route button in either the Oscillator, 2-Track, or Talkback sections.

**2** Do either of the following:

- If you had already selected the desired output, click to confirm the currently displayed Route To mode (in the lower left corner of the screen).
- Go to the Outputs page and click to select an output (it flashes briefly, otherwise the Outputs page remains focussed on the currently selected Output channel).

**3** In the confirmation dialog that appears, click Route to confirm your assignment or click Cancel to cancel without changing the current routing.

For more information, see Chapter 12, "Patchbay."

## System Clock

Sets the date and time for the system.

### Time of Day in Status Display

You can choose to show time of day in the lower right corner of the screen in the Status display area. This optional display can be configured for either 12 hour (AM/PM) or 24 hour format as follows:

#### To show time of day in the Status area:

**1** Go to the Options > Misc page.

**2** In the System Clock section, enable the Show Time in Status Area option.

**3** Select a format for the displayed time: 12 hour (AM/PM) or 24 hour.

Time of day is shown whenever the status of the plug-in racks is OK; plug-in rack status messages (if any) temporarily replace time of day display to alert you to plug-in rack status.

## Channel Delay

Lets you set the display units on all applicable input and output delay controls. This makes it possible to set the delay based on any of the following:

- delay time (in milliseconds)
- distance to the source (in feet or meters)
- number of samples of delay

## Tap Tempo

Lets you set the global system tempo, toggle system tempo on/off, and choose to display tempo in BPM or ms.

**On** Turn on the global tempo sync by clicking the On switch directly below the encoder so that it is lit (on).

**Tempo** Sets a system tempo value using the encoder or by typing a value directly into the Tempo field.

**Units** Lets you choose Beats Per Minute (BPM) or Milliseconds as the units for displayed values.



Tap Tempo controls in the Options > Misc page

 For more information, see “Tap Tempo for Plug-ins” on page 213.

## Mouse

### Pointer Speed and Mouse L/R Settings

You can customize the response speed for the trackball (or mouse) and on-screen cursor, and reverse the left/right assignment of the Trackball buttons, from the Options > Misc page.

#### To customize Pointer Speed:

- 1 Go to the Options > Misc page.
- 2 Do any of the following:
  - To adjust cursor speed, click the Pointer Speed pop-up menu and choose a higher value for faster response, or a lower value for a slower response.
  - To reverse the left/right assignment of the two Trackball buttons, click to enable Switch Buttons.

## Interaction

The Interaction page lets you configure behaviors for the Selected Channel (ACS) sections, Input Safe Switches, Lights, Meter, Ethernet, and LCD Display.



Interaction tab of the Options page

### Assignable Channel Selection

Options in this section set the mechanism by which channels are targeted on the Selected Chan sections (also known as the ACS, or Assignable Channel Section).

#### To customize console and screen interaction:

- 1 Go to the Options page and click the Interaction tab.
- 2 Set the following Assignable Channel Selection options:

#### Change Target By

The Change Target By options let you specify whether the following actions target a channel on the ACS. More than one option can be selected simultaneously.

- Touching Input Faders
- Engaging Input Solos
- Touching Output Faders
- Engaging Output Solos

#### Targeting Changes View Mode

The Targeting Changes View Mode option updates the on-screen display to show the page for the channel targeted. When this option is deselected, the on-screen display does not update when a channel is targeted.



## Meter

Metering settings provide the following options for meter ballistics, peak, and clip indication.

**Ballistics** This option lets you choose RMS or Peak ballistics for the control surface and on-screen meters.

**Input Clip Margin and Output Clip Margin** These options set the level, relative to the maximum (full scale) level, at which a clip is reported on a channel. When a clip is detected, the entire channel meter turns red.

### To set Input or Output clip margin:

- 1 Click in the dB Below Max edit box for Input Clip Margin or Output Clip Margin.
- 2 Enter a value or drag to change the value and press Enter.

The entered value is interpreted as a relative dB value from the maximum (where “Max” is considered +20 dBVU). For example, with the Input Clip Margin set to 6 dB below max (the default), peak levels within 6 dB of maximum level will trigger a clip indication

**Clip Hold Time and Peak Hold Time** These options specify how long clips and peaks are held. Default is 2 seconds for both Clip and Peak hold.

## Input Safe Switches

The Input Safe Switches let you control three independent Safe functions: Automation Safe, Solo Safe, and Bank Safe. Only one of these Safe functions can be viewed and controlled at a time.

**Act as Automation Safes** When selected, this option sets the console Safe switches and on-screen channel Safe buttons to toggle the Automation Safe status of the corresponding channel. For more information, see Chapter 21, “Snapshots.”

**Act as Solo Safes** Solo Safe applies only to Input Channels and FX Returns. When selected, this option sets the Safe switches to toggle the Solo Safe status of the corresponding channel. See “Solo Bus Operation” on page 121.

**Act as Bank Safes** When selected, this option sets the Safe switches of Input Channels and FX Returns to toggle that channel’s Bank Safe Status. (Bank Safe keeps channels at the top fader layer, immune to input banking.) For more information, see “Bank Safe Mode for Input Safe Switches” on page 46.

## Ethernet Control

Ethernet Control settings let you configure the following:

**Network Settings** These settings let you configure ECx Ethernet Control to remotely control VENUE over a wireless Ethernet network.

**Control Settings** These settings let you configure VENUE Link to integrate a Pro Tools system with VENUE.

 For more information about ECx Ethernet Control, see Chapter 30, “ECx.” For information about VENUE Link, see the Live Recording Guide.

## Lights

Console and LED/Display settings let you adjust the brightness of the following items:

**Console Lights** Adjust brightness of external lights connected to the Console Lights connectors on the back panel.

**LEDs and Displays** Adjust brightness of LED and LCD displays on the control surface.

## Displays

These options let you customize the behavior of the control surface LCDs.

**Viewing Angle** This option lets you configure the Selected Channel and Snapshots LCD displays for optimum viewing.

**Show Channel Strip Value While Moving Fader** This option determines what is displayed in the Channel Name display when a fader is adjusted. When selected (default), the Channel Name display switches from showing channel name to showing the value (level) when a fader is adjusted. When deselected, the Channel Name displays do not show values when a fader is adjusted.

**Show VCA Contribution** This option lets you display a secondary, transparent fader cap on each on-screen fader strip that represents the effective gain of the channel (channel gain plus associated VCA gain, if any). For more information, see “Assigning and Using VCAs” on page 86.

## Events

The Events tab of the Options page lets you use the Event List to customize the function of switches, footswitches and General Purpose Interface (GPI)-connected devices. For information, see Chapter 22, “Events.”



Options > Events page

## Plug-Ins

The Plug-Ins tab of the Options page is used to install plug-ins on the VENUE system. The Plug-Ins tab is available on complete VENUE systems only. It is not available in the Stand-alone software.



# Rate-Signaling



# Chapter 7: Inputs and Input Routing

This chapter shows how to do the following:

- Configure inputs (system settings for input channels), name channels, Make Stereo and Split to Mono)
- Assign input sources to Input Channels in the Patchbay
- Route input channels to Mains, Groups, and Aux Sends, to Matrix mixers and other output busses, and to plug-ins
- Adjust input channel parameters

---

## Configuring Inputs

Two types of inputs are available: Input Channels and FX Returns.

### Input Channels

*Input Channels* are used to control inputs from stage and mix position (local) audio inputs, from Pro Tools, or from bus-fed plug-ins.

Input channels can be mono or stereo. Each mono channel controls one input, and each stereo channel controls two inputs in tandem. Input channels can appear on any of the input channel strips. Up to 96 mono input channels, maximum, are available, depending on your system and rack configuration. Input channels are displayed in banks on the 16 control surface input channel strips.

### FX Returns

Effects Return channels (or *FX Returns*) are used to control signals from bus-fed plug-ins, from external hardware, or from Pro Tools.

FX Returns are always stereo, and appear on input channel strips 1–8 and 9–16. Up to 16 stereo FX Returns are available.

## Configuring Input Channels

**To set the number of available Input Channels:**

- 1 Put the system into Config mode.
- 2 Go to the Options page and click the System tab.
- 3 Click Edit.
- 4 Choose the number of channels from the Input Channels pop-up menu.

- 5 Click Apply. The system restarts with the new Input Channel configuration.

**▲** *Audio will be interrupted when this configuration change is applied.*

### Configuring FX Returns

VENUE Mix Rack and Profile systems provide up to 16 stereo FX returns. You can choose to use either 8 or 16; choosing fewer FX Returns leaves more DSP available for plug-ins. For details, see “Configuring FX Returns” on page 69.

## Combining Input Channels (Make Stereo)

Pairs of mono input channels can be combined to make stereo channels, whose left and right sides are then controlled by one input channel strip.

**To combine two mono input channels into a single stereo channel:**

- 1 Put the system into Config mode.
- 2 Select two mono channels by doing either of the following:
  - On the console, press and hold the Multi-Select switch, then press Select on each of the two mono channel strips you want to combine.
  - or –
  - On-screen, go to the Inputs page and click a fader strip to select the first mono channel, then hold Shift and click to select the second mono channel you want to combine.
- 3 Right-click either of the selected mono channels on-screen and choose Make Selected Mono Strips Stereo.



*Two mono inputs about to be combined into one stereo channel*

Each selected channel is combined with the next-highest selected channel, even if the selected channels are not contiguous. Blank strips are created and inserted where necessary to maintain channel layout in that bank. Parameter values from the leftmost channel of each pair are applied to both channels, and the pan control becomes a Balance/Width control.

Combined channels are shown in the patchbay as left and right sides of the Input Channel name. FX Returns are always stereo, so they cannot be combined or split.

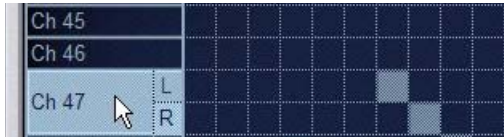

*Stereo Input Channel in the Patchbay Input page*

On the console, the channel St (Stereo) LED lights to indicate that a channel is a stereo channel.

**To split a stereo channel into two mono channels:**

- 1 Put the system into Config mode.
- 2 Select the stereo channel you want to split.
- 3 Right-click the selected channel and choose Split Selected Stereo Strip to Mono.

Each selected stereo channel is split, placing the channels next to each other on the console and in the Patchbay. Blank strips are deleted to maintain channel layout.

**Naming Channels**

Input Channel and FX Return channel names can be changed from the Inputs page or from the Patchbay.

**To change the name of an Input Channel or FX Return channel:**

- 1 Go the Patchbay page and click the Inputs tab.
- 2 Target the channel whose name you want to change by pressing its Select switch or selecting it on-screen.
- 3 Double-click the channel name.



*Changing the name of an Input Channel in the Inputs page*

- 4 Type a new name and press Enter on the computer keyboard.

 *When naming channels in the Patchbay, you can double-click the channel name shown in the columns of the grid and type a name; press Tab on the keyboard to go to the next channel and Shift+Tab to go to the previous channel.*

**Assigning Input Sources to Channels**

Inputs sources are assigned to Input Channels or FX Returns in the Patchbay. Available input sources for Input Channels or FX Returns include:

- Stage inputs (Mix Rack stage I/O, or Stage Rack)
- Local FOH inputs (2-Track sources, Talkback, Oscillator)
- Pro Tools outputs (HDx or FWx)
- Plug-In outputs

**To assign an input source to an Input Channel or FX Return:**

- 1 Go to the Patchbay page and click the Inputs tab.
- 2 To the left of the channel grid, click the Channels tab or the FX Returns tab.
- 3 Click the Stage, FOH, or Pro Tools tab to display the desired type of input sources.
- 4 Click in the channel grid to assign an input source to an Input Channel or FX Return.



*Assigning input sources in the Patchbay Inputs page*

The Inputs tab of the Patchbay shows the input source and destination above the grid. Input source is also shown below the channel name in the Inputs and Patchbay Inputs page.

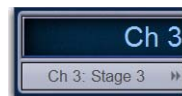

*Input source assignment shown in the Inputs page*

A single input source can be assigned to multiple Input Channels or FX Returns (you can fan out a source to multiple channels). Gain control, phantom power and pad settings are linked across the channels. Each Input Channel or FX Return may be fed by only one input source (multiple sources cannot be routed to a single channel).

**Assigning Bus-Fed Plug-Ins, Osc/Talkback/2-Track**

Bus-fed plug-ins can be patched to Input Channels and FX Returns from the Plug-In Rack (see “Using Plug-Ins as a Bus Processor” on page 160).

You can also route the built-in Oscillator, Talkback input, and 2-Track sources to input channels (see “Routing the Oscillator” on page 128).

## Routing Input Channels

Input channels and FX Returns can be routed to the Mains, Groups/Var Groups, Auxes, Matrix mixers and PQ busses.

### Routing Channels to the Mains and Groups Busses

Input channels and FX Returns can be routed to the Mains and Groups busses using the Bus Assigns section of the ACS.

#### To route one or more input channels to Mains and Groups busses on the console:

- 1 Do either of the following:
  - To select a single channel, press its Select switch.
  - To select multiple channels, press Select on the first channel, hold the Multi-Select switch (located to the left of the input faders), then press the Select switches on the other channels.
- 2 To route to Mains, press the L-R (left and right) and/or C/Mono (center/mono) switch in the Bus Assigns section so that is lit.
  - or –
  - To route to a Group bus, press a Groups 1–8 switch.

The L-R, C/M and 1–8 Bus Assign LEDs on each channel light to indicate routing to the corresponding busses.

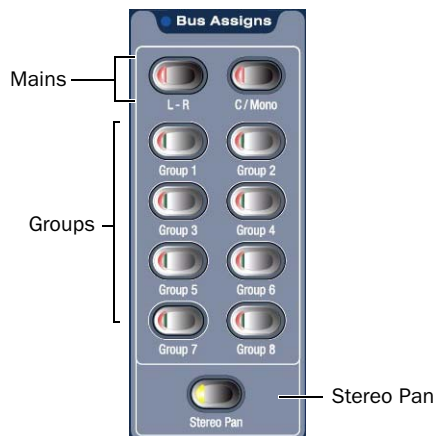

Bus Assign switches

#### To route channels to Mains or Groups on-screen:

- 1 Select one or more channels.
- 2 Go to the Inputs page.
- 3 Click the Bus Assign buttons to route to those busses.

 For information on configuring the system Mains as L-R plus Mono, or as L-C-R, see “Configuring Aux, Group, and Variable Group Busses” on page 80. For more information on configuring Group busses, see “Configuring Aux, Group, and Variable Group Busses” on page 80.

## Routing Channels to Aux Sends

Input channels and FX Returns can be routed to Aux sends using the input encoders, using the ACS, or on-screen.

#### To route channels to Aux sends using the input encoders:

- 1 Press an Encoder assign Send switch 1–2 through 15–16.
  - The first press of an Aux Send switch assigns level control of the odd-numbered send to the encoders. The switch lights green to indicate an odd-numbered selection.
  - The second press of an Aux Send switch assigns level control of the even-numbered send to the encoders. The switch lights yellow to indicate an even-numbered selection.

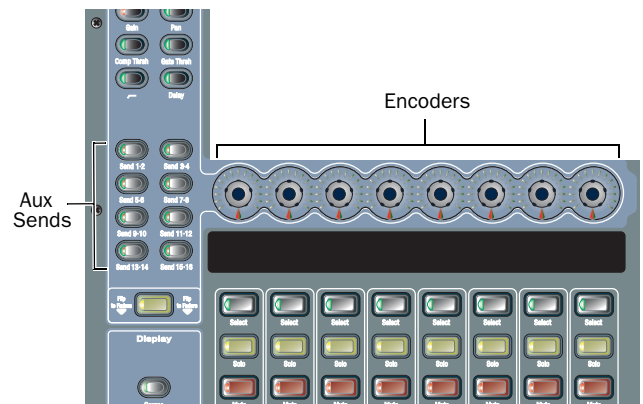

Encoder assignment switches for input channels

2 For each channel you want to assign to the selected Aux Send bus, press its channel encoder so that its “On” indicator LED lights.

- 3 To set the Aux Send level, do either of the following:
  - Turn the encoder on each channel.
  - Press the Flip to Faders switch, then adjust the channel fader.

#### To route channels to Aux Sends busses using the ACS:

- 1 Do either of the following:
  - To select a single channel, press its Select switch.
  - To select multiple channels, press Select on the first channel, hold the Multi-Select switch (located to the left of the input faders), then press the Select switches on the other channels.
- 2 In the Aux Sends section, press the Aux 1–8 or 9–16 switch to bank it to the corresponding pairs of Aux Sends.
- 3 Press an Aux Sends encoder to enable that send.
- 4 Rotate the encoder to adjust that send level.

## Configuring Aux Busses (Aux Sends)

VENUE systems can be configured to have 8 or 16 Aux busses as part of the overall Aux/Group bus configuration. Mono Aux busses can be linked in odd/even pairs to function in stereo (see “Configuring Aux and Variable Group Busses” on page 95).

## Routing Channels to Variable Groups

### To access Variable Group sends:

- 1 Make sure the system is configured for Variable Groups mode. (See “Configuring Aux, Group, and Variable Group Busses” on page 80.)
- 2 Select one or more input channels.
- 3 Press the Variable Groups switch in the Aux Sends section of the ACS. Or, click the Var Groups button in the on-screen Bus Assign section (on the Inputs page for the selected channel). Variable Groups 1–8 are now mapped to the ACS Aux Send section, and from the assignable input encoders 1–8.
- 4 Press an encoder to enable the selected (Var Group) Aux Send.
- 5 Rotate the encoder to adjust send level.
- 6 For more information, see Chapter 10, “Aux Sends and Variable Groups.”

## Routing Channels to Matrix and PQ Busses

Matrix and PQ source assignments determine input signal routing to each of the Matrix and PQ mixers. Matrix and PQ source inputs can include up to 12 inputs per mixer.

Matrix and PQ signal routing is performed from the Matrix and PQ tabs of the Outputs page (see Chapter 11, “Matrix and Personal Q Mixers”).

## Assigning Channels to VCAs

Channels can be assigned to VCAs for consolidated control of multiple channels.

### To assign one or more channels to a VCA:

- 1 Press the VCA switch to bank the Output Faders to VCAs.
- 2 Select the VCA (1-8) you wish to assign to by pressing its Select switch.
- 3 Press the Multi Assign switch near the Output encoders. While engaged, the Multi Assign and output Select switch LEDs flash.
- 4 Press the Select switch on the inputs or outputs you want assigned to the currently targeted VCA. Use the Input and Output Fader bank switches to access the desired channel strips.

- 5 Press the Multi Assign switch again to confirm the action.

– OR –

Select another VCA to confirm the current assignment but remain in Multi Assign mode for the newly targeted VCA.

For more information on VCAs, including using VCA spill, see “Assigning and Using VCAs” on page 86.

## Routing Inputs to Direct Outputs

All Input channels and FX Returns have Direct Outputs, which can be assigned to hardware outputs, used as inputs to plug-ins, and sent to Pro Tools. Direct Outs are assigned in the Patchbay, and can be controlled from the ACS or on-screen.

### To enable and adjust Direct Outputs:

- 1 Select the input or FX return channel.
- 2 Press the Direct Output encoder to toggle it in and out on the selected channel.
- 3 Rotate the Direct Output encoder to adjust the output level.



Direct Output encoder

For more information on routing and assigning Direct Outputs, see “Direct Outputs” on page 85.

---

## Using Built-In Dynamics and EQ

Each Input Channel has built-in Dynamics processors, a High-Pass Filter and a 4-band EQ; each FX Return has a built-in 2-band EQ. If the channel is a stereo channel, the processor controls are linked and apply to both the left and right sides of the channel.

## Using Dynamics on Channels

A built-in Compressor/Limiter and Expander/Gate are available on each Input Channel. Controls for all of the built-in dynamics processors are provided in the ACS Dynamics section, and an input/output curve appears on-screen.

## Compressor/Limiter

### To engage the built-in Compressor/Limiter on the selected channel:

- Press the Comp/Lim In switch in the ACS Dynamics section.

### To engage the built-in Compressor/Limiter on any input channel:

- 1 Bank to the desired channels.
- 2 Press the Comp Thrs switch to assign the input encoders to the built-in Compressor/Limiter.
- 3 Push the assignable encoder on each channel you want the built-in Compressor/Limiter engaged.

### To adjust the Compressor/Limiter threshold from a channel:

- 1 In the Encoder Assignment section, press the Comp Thrsh switch.
- 2 Turn the assigned rotary encoder to set the Compressor/Limiter threshold value.

### To adjust Compressor/Limiter controls from the ACS:

- 1 Target a channel by pressing its Select switch.
- 2 Press the Select switch next to the Comp/Lim In switch in the ACS Dynamics section. The switch lights to indicate control of the Compressor/Limiter.

## Expander/Gate

### To engage the built-in Expander/Gate on the selected channel:

- Press the Exp/Gate In switch in the ACS Dynamics section.

### To engage the built-in Expander/Gate on any input channel:

- 1 Bank to the desired channels.
- 2 Press the Gate Thrs switch to assign the input encoders to the built-in Expander/Gate.
- 3 Push the assignable encoder on each channel you want the built-in Expander/Gate engaged.

### To adjust the Expander/Gate threshold from a channel:

- 1 In the Encoder Assignment section, press the Gate Thrsh switch.
- 2 Turn the assigned rotary encoder to set the Expander/Gate threshold value.

### To adjust Expander/Gate controls from the ACS:

- 1 Target a channel by pressing its Select switch.
- 2 Press the Select switch next to the Exp/Gate In switch and meter in the ACS Dynamics section. The switch lights to indicate control of the Expander/Gate, and indicator LEDs below each encoder light red to show that these controls are mapped to Exp/Gate functions.

## Using EQ on Channels

A built-in High-Pass Filter and 4-band EQ are available on each Input Channel and a 2-band EQ is available on each FX Return. Modular controls for all of the built-in EQ processors are in the ACS EQ section, and an EQ response curve appears on-screen.

One of two EQ types can be selected for the built-in EQ, on a per-channel basis: a full-spectrum parametric digital EQ or an analog-modeled EQ.

### To use the built-in EQ on a channel, do one of the following:

- 1 Target the channel by pressing its Select switch.
- 2 Do any of the following:
  - To engage the channel High-Pass Filter, press the HPF switch in the Encoder Assignment section. Toggle HPF in/out on each channel by pressing its encoder; adjust HPF frequency by rotating its encoder.
  - To engage the built-in 4-band or 2-band EQ, press the EQ In switch at the bottom of the ACS Equalizer section.

 For more information, see Chapter 17, “EQ.”

---

## Using Inserts on Channels

You can use software plug-in inserts or hardware inserts on any Input Channel or FX Return.

### Using Plug-In Inserts on Channels

Plug-Ins are arranged in virtual racks, which allow signals to be sent to and from each plug-in as if it were an external processor. Plug-Ins can be used in two ways: as inserts, or as effects in a Send/Return arrangement.

**Insert** The plug-in is patched in at the insert point on an Input Channel or FX Return. Each Input Channel may have up to four plug-in inserts.

**Send/Return** Signal is sent to the plug-in over any of the system busses (usually an Aux Send) and routed back to an Input Channel or FX Return.

For more information on using plug-ins in a Send/Return arrangement, see “Using Plug-Ins as a Bus Processor” on page 160.



## Inserting Plug-Ins on Channels

You can insert plug-ins on Input Channels and FX Returns directly from the Inputs page or from the Plug-In Rack.

 See Chapter 18, “Plug-Ins.”

### To insert a plug-in on a channel:

- 1 Go to the Inputs page and target the channel where you want to insert the plug-in.
- 2 In the Inserts section of the Inputs page, do one of the following:
  - Click one of the four Plug-In Insert pop-up menus and choose a plug-in directly from one of the Plug-In Rack submenus.
  - or –
  - Click one of the four Plug-In Insert buttons to go to the Plug-In Rack, and route the signal to the plug-in using Plug-In Rack controls.

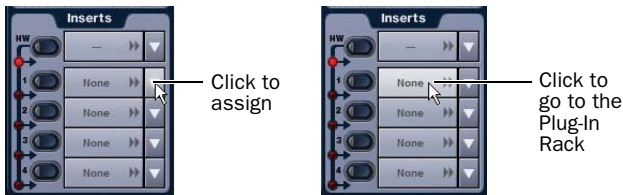

Assigning a plug-in insert in the Inputs page

The name of the plug-in insert appears in the on-screen Plug-In Insert display.

## Using Hardware Inserts on Channels

You can insert external processors in the signal chain of Input channels and FX Returns.

 Outputs also provide hardware inserts. For more information, see “Using Inserts on Output Busses” on page 82.

### Assigning Hardware Inserts to Inputs

You can assign hardware inserts to Input channels and FX Returns directly from the Inputs page or from the Patchbay.

### To assign a hardware insert to an input:

- 1 Go to the Inputs page and target the channel where you want to assign the hardware insert.
- 2 In the Inserts section of the Inputs page, do one of the following:
  - Click the Hardware Insert pop-up menu and choose an insert destination directly from the menu.
  - or –
  - Click the Hardware Insert button to go to the Inserts page of the Patchbay, and assign the insert from the Patchbay.

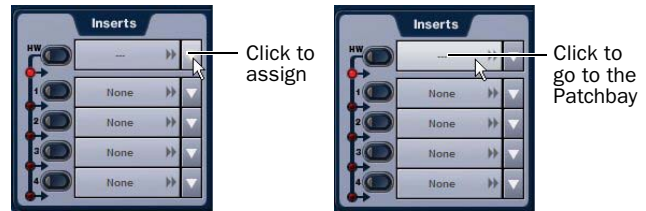

Assigning a hardware insert in the Inputs page

The name of the hardware insert destination appears in the on-screen Hardware Insert button.

### Setting the Hardware Insert Location

You can choose the location of the hardware insert in the signal path, relative to the four plug-in inserts, for each channel. A hardware insert does not need to be currently assigned to do this.

### To set the hardware insert location:

- 1 Go to the Inputs page and target the channel where you want to set the hardware insert location.
- 2 In the Inserts section of the Inputs page, click the hardware insert indicator so that it lights red.

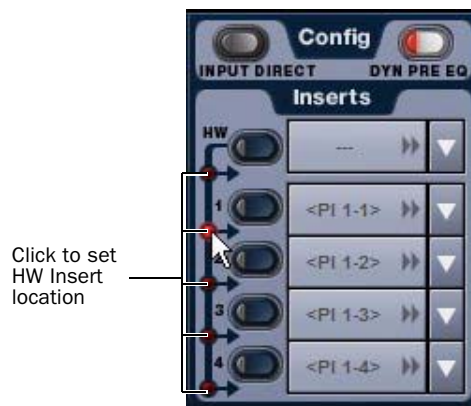

Setting a hardware insert location in the Inputs page



## Activating and Bypassing Inserts

After hardware and plug-in inserts are assigned, they can be activated and bypassed from the from the ACS section or the corresponding Input page controls.

### To activate or bypass a plug-in insert from the ACS section:

- 1 Target the channel by pressing its Select switch.
- 2 Press any of the Plug-In switches in the Insert Processing section to activate or bypass the corresponding Insert. The switch lights when the insert is activated.

### To activate or bypass a hardware insert from an input channel or FX Return:

- 1 Go to the Inputs page and target the channel.
- 2 Click the In/Out switch for the HW insert (at the top of the Inserts section) on the channel. The switch lights when the insert is in-circuit.

## Adjusting Input Controls

### Input Gain

Input Gain is adjustable from the rotary encoders on each Input channel and FX Return. Mic inputs have a gain range from +10 dB to +60 dB. Analog line inputs and digital inputs have a gain range from -20 dB to +18 dB.

### Gain Guess Feature

The automated Gain Guess function can be used to set a nominal level for a channel based on its incoming signal. When you press and hold a rotary encoder assigned to input gain, the system samples incoming signals and automatically sets the channel gain and pad for a 0 dB reference when the encoder is released. Gain Guess follows the current Meter mode (Peak or RMS).

### Gain Indicators

When Gain is displayed on the input encoders, the encoder's indicator LED lights to indicate that the gain is set to the default value (+10 dB for analog inputs, and 0 dB for digital inputs). Gain change is indicated by the encoder ring LEDs, and gain value is shown in the channel display when adjusted.

## Setting Input Gain

Gain can be controlled from individual channel strips or from the ACS section.

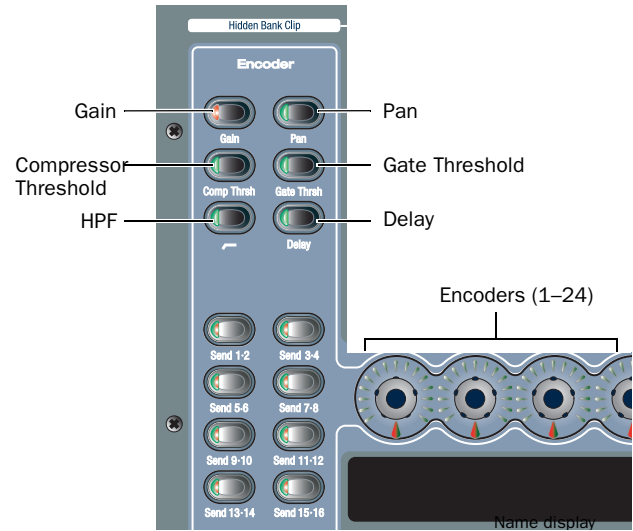

Assignment switches for input channel encoders

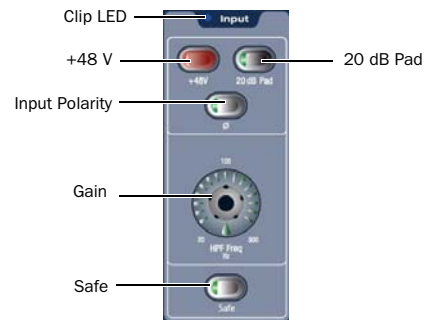

Input controls in the ACS

### To adjust input gain for a channel:

- 1 Do one of the following:
  - In the Encoder Assignment section, press the Gain switch to assign gain control to the rotary encoders.
  - OR –
  - Target the channel by pressing its Select switch. Gain control for the channel is assigned to the Gain rotary encoder in the ACS Input section.
- 2 Adjust gain by turning the assigned rotary encoder.

#### To set input gain using the Gain Guess feature:

1 Press and hold the assigned rotary encoder while the channel is receiving input signal. The LED flashes to indicate level sampling.

– or –

■ Click Guess on-screen.

1 Release the rotary encoder to the current gain guess. Gain will be set so the incoming signal reaches 0 dB peak (if Peak mode is selected) or 0 dB RMS (if RMS mode is selected).

#### Setting Right Offset on Stereo Channels

On stereo Input Channels and FX Returns, the Gain control affects both the left and right channels. The Right Offset feature lets you offset the gain of the right channel relative to the left channel by –20 dB to +20 dB, within the overall gain limits.

#### To adjust channel gain offset for a stereo channel on-screen:

- 1 Go to the Inputs page and target the stereo channel.
- 2 Adjust the right channel gain using the on-screen Right Offset encoder.

#### Stereo Level Offset Indication

The Stereo LED below the channel meter flashes when the difference in signal level between the left and right channels is 12 dB or greater.

#### Pan/Balance

Pan adjusts channel pan (for mono input channels) and stereo balance (for stereo input channels and FX returns).

#### To adjust channel pan/balance from the encoders:

- 1 In the Encoder Assignment section, press the Pan switch to assign pan/balance control to the rotary encoders.
- 2 Adjust the channel pan/balance by turning the assigned rotary encoder.

#### Stereo Width

Width adjusts the stereo image of stereo input channels and FX returns by controlling ganged pan positions of the left and right channels, in opposite directions.

Width can be adjusted from full L–R, to mono, to full reversed L–R. Width controls are not available on mono channels.

#### To adjust width of a stereo channel on-screen:

- 1 Select one or more channels.
- 2 In the Inputs page, adjust width by turning the on-screen Width rotary encoder. Turning the encoder clockwise moves the width to full stereo, and counter-clockwise moves the width to reverse stereo. The center position represents mono.

#### High-Pass Filter

A built-in 4th-order High-Pass Filter can be engaged on each input channel. The HPF corner frequency range is from 20 Hz to 500 Hz.

#### To engage the built-in HPF from the Input encoders:

- 1 In the Encoder Assignment section, press the HPF switch to assign HPF control to the rotary encoders.
- 2 Press a channel rotary encoder to insert the filter in that channel. The rotary encoder “On” indicator LED lights when the HPF is in circuit.
- 3 Adjust the HPF corner frequency by turning the assigned rotary encoder.

#### Phantom Power

48V phantom power can be applied to any analog stage input assigned to an input channel or FX return.

#### To apply phantom power to an input:

- 1 In the patchbay, assign a stage input to a channel. See “Assigning Input Sources to Channels” on page 70.
- 2 Target the channel by pressing its Select switch.
- 3 Press the +48V switch in the ACS Input section. The switch lights when phantom power is applied.

 *If an input is moved to a different channel, the gain, pad, and phantom power setting will move with the input.*

#### 20 dB Pad

A 20 dB pad can be applied to any analog Stage input assigned to an input channel or FX Return.

#### To apply a 20 dB pad to a Stage input:

- 1 Target the channel by pressing its Select switch.
- 2 Press the 20 dB Pad switch in the ACS Input section. The switch lights when the pad is applied to the Stage input.

 *The Gain Guess feature turns the Pad on or off as needed to accommodate incoming signal level*

## Input Polarity (Phase) Invert

The polarity of any input channel or FX return signal can be inverted. With stereo channels, only the left channel is inverted.

### To invert the polarity of a channel:

- 1 Target the channel by pressing its Select switch.
- 2 Press the polarity inversion (Ø) switch in the ACS Input section. The switch lights when the polarity is inverted.

## Safe

The Safe switch toggles Automation Safe, Solo Safe, or Bank Safe on/off. The current function of the ACS Safe switch is determined by the current Input Safe switch assignment in the Options > Interaction page.

When a Safe mode is enabled for the currently selected channel, the ACS Safe switch lights if that Safe mode is the currently assign Input Safe Switch mode. Channel safe status is also indicated by the lit or unlit state of each channel strip Safe LED.

To configure the Safe switches for Automation, Solo or Bank mode, see “Input Safe Switches” on page 65.

### To toggle the current Safe state of a channel:

- 1 Target the channel by pressing its Select switch.
- 2 Press the Safe switch in the ACS Input section. The switch lights solid when the current channel is Automation Safe, flashes when the channel is Solo Safe, and flashes rapidly when in Bank Safe.

## Delay

A variable delay can be applied to any Input Channel or FX Return. The delay range is from 0 to 250 milliseconds.

### To apply delay to a channel from the console:

- 1 In the Encoder Assignment section, press the Delay switch to assign delay control to the rotary encoders.
- 2 Press the assigned rotary encoder to apply delay to the channel. The encoder indicator LED lights when delay is applied.
- 3 Adjust the assigned Delay encoder to set the desired amount of channel delay.

## Channel Solo

Three Solo modes are available: Solo In Place (SIP), Pre-Fader Listen (PFL), and After-Fader Listen (AFL), and several options are available for configuring Solo bus operation. Channels can also be implicitly soloed as part of a VCA.

 See Chapter 14, “Solo and Monitor Busses.”

### To solo a channel:

- Press the channel’s Solo switch. The Solo switch lights solid to indicate the channel is explicitly soloed.

## Channel Mute

### To explicitly mute a channel:

- Press the Mute switch on the channel. The mute switch lights solid to indicate the channel is explicitly muted.

 Channels can be muted in three ways: explicitly with the channel mute switch; implicitly as a result of another channel being soloed, and as a member of a Mute Group or VCA. For more information see Chapter 15, “Muting and Mute Groups”

## Channel Level

Channel level can be adjusted from the Input or FX Return faders and using the on-screen faders. The currently selected channel(s) can also be adjusted from the Flex Channel.

Input channel levels can also be affected by VCAs. For more information, see “Assigning and Using VCAs” on page 86.

## Channel Faders

Channel Faders provide channel level control from  $-\infty$  (–INF) to +12 dB. Use the faders on the console, or on-screen, to adjust individual channel levels.

 For more information on input and output fader banking, see Chapter 5, “Navigating and Selecting Channels.”

## Digital Input Sources

On systems that include a DSI (Digital Stage Input) card, the following additional settings and displays are provided.

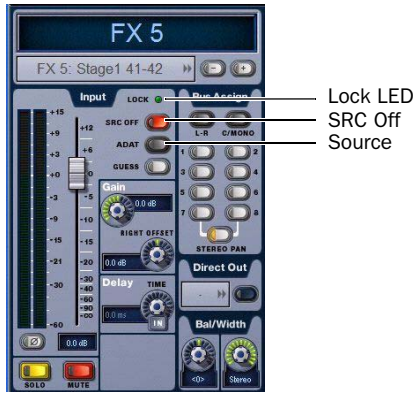

*Input controls for a DSI channel*

**Lock LED** Indicates lock status for the channel, and mirrors the same LED on the DSI card.

**SRC Off** Toggles Sample Rate Conversion on or off for that channel, and mirrors the same LED on the DSI card. A lit SRC Off switch indicates that SRC is disabled.

**ADAT (Source)** Enables the ADAT Optical port as the active input source on the DSI card. When lit, the DSI card is clocking and listening to corresponding ADAT input; when dark, the channel is receiving input from the corresponding AES input.

Direct Outs are also available on DSI-fed channels, and their pickoff point can be specified in the patchbay.

---

## Using Input Direct

Input Direct mode lets you completely bypass the built-in dynamics and EQ processing, and all inserts on input channels and FX returns. This mode routes the input signal directly from the Top of Channel pickoff to the channel fader.

**To bypass all processing on an input channel or FX return:**

- 1 Target the channel by pressing its Select switch.
- 2 Go to the Inputs page.
- 3 Click the Input Direct button in the Config section of the Inputs page for the selected channel. The button flashes to indicate Input Direct mode is active.



*Input Direct button*

# Chapter 8: Outputs and Output Routing

This chapter shows how to do the following:

- Configure and name Mains, outputs and busses
- Assign outputs and busses to hardware outputs in the Patchbay
- Route outputs to Mains, Groups, Aux Sends, and Matrix mixers
- Using plug-in inserts, and using Graphic EQ on outputs
- Assign and route Direct Outputs
- Adjust output channel parameters
- Use VCAs

---

## Configuring Outputs

The following types of output busses are available: Mains, Groups (or Variable Groups), Auxes, Matrix mixers, and Personal Qs.

### Mains

The Main busses can be configured in L-R+M or L-C-R formats. The Main busses are controlled from the dedicated Mains controls and fader in the Output section.

### Configuring the Main Busses

The Main busses can be configured to operate as either:

**L-R plus Mono** Pans signals between the left and right channels to the L-R bus, and sums signals to a separate mono bus.

**L-C-R** Pans signals across left, center and right channels.

**⚠** *Audio may be interrupted or may change levels during this configuration procedure.*

#### To configure the Main busses:

- 1 Put the system into Config mode.
- 2 Go to the Options page and click the System tab.

- 3 Click Edit.

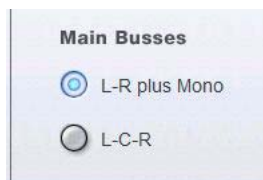

#### Setting the Main bus configuration

- 4 Select the configuration for the Main Busses.

- 5 Click Apply. The system restarts with the new Main bus configuration.

### Groups

Eight Group busses are available. These Group busses can be globally configured to be mono or stereo as part of the system Aux/Group bus configuration. See "Configuring Aux, Group, and Variable Group Busses" on page 80.

Group outputs can be controlled from the faders and encoders in the Output section.

 See Chapter 9, "Groups."

### Auxes

Up to 16 Aux busses are available. The number of available Aux busses is set as part of the system Aux/Group bus configuration. See "Configuring Aux, Group, and Variable Group Busses" on page 80.

Aux bus outputs can be controlled from the Output faders.

 For more information, see Chapter 10, "Aux Sends and Variable Groups."

### Variable Groups

When the system is in Variable Groups mode, the 8 Group busses operate in much the same way as Aux busses.

When set to Variable Groups mode, the Output section has 16 available Aux busses and 8 available Variable Group busses, letting you send independently controllable signals to all 24 busses in the system.

Variable Groups mode is set as part of the system Aux/Group bus configuration. See "Configuring Aux, Group, and Variable Group Busses" on page 80.

## Matrix Mixers and Personal Qs

Eight Matrix mixers and 8 Personal Q mixers are available. Each Matrix mixer is a discrete 12-in/1-out (mono) submixer, with the ability to link adjacent Matrix mixers into stereo pairs. Each PQ mixer is a discrete 12-in/2-out (stereo) submixer.

Matrix mixer and Personal Q input sources can include up to 12 inputs, selectable from any combination of Aux, Group or Mains busses plus up to 8 unique input channels, FX returns or hardware inputs. Pre- and post-fader tap for Matrix and PQ sources are assigned in the Pickoffs tab of the Options page.

 *User Source input assignments are stored in Snapshots as part of their distinct Matrix or PQ data type.*

Matrix mixer and PQ mixer outputs are controlled from the output faders; matrix inputs are controlled from the encoders when a particular matrix is selected.

 *See Chapter 11, “Matrix and Personal Q Mixers.”*

## Configuring Aux, Group, and Variable Group Busses

Auxes and Groups (or Variable Groups) share the available system busses. Configuration options include the following:

**8 Auxes + 8 Stereo Groups** Divides the available system busses between 8 mono Aux busses and 8 stereo Group busses.

**16 Auxes + 8 Mono Groups** Divides the available system busses between 16 mono Aux busses and 8 mono Group busses.

**16 Auxes + 8 Variable Groups (24 Bus)** Divides the available system busses between 16 mono Aux busses and 8 mono Variable Group busses (enables Variable Groups mode).

 *Audio may be interrupted or may change levels during this configuration procedure*

### To configure the Aux/Group/Variable Group busses:

- 1 Put the system into Config mode.
- 2 Go to the Options page and click the System tab.
- 3 Click Edit.
- 4 Select a bus configuration.

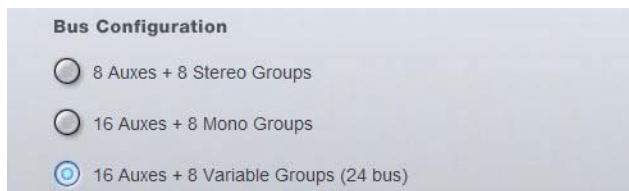

### Selecting a bus configuration

- 5 Click Apply. The system restarts with the new bus configuration.

## Data Cleared When Changing Bus Configurations

When the bus configuration is changed, all settings are cleared (or set to default) from the current console settings and from all stored snapshots, for all Groups.

## Linking Aux Busses

You can link odd/even bus pairs and pan input signals into those bus pairs. Aux bus pairs are linked on a global basis, and appear as linked on all channels. For information on linking Auxes, see “Linking Aux and Variable Group Busses for Stereo Operation” on page 95.

## Naming Channels

Output channel names can be changed from the Outputs page or from the Patchbay.

### To change the name of an Output channel:

- 1 Go to the Outputs page or the Patchbay page.
- 2 Target the channel whose name you want to change by pressing its Select switch or selecting it on-screen.
- 3 Double-click the channel name.



### Changing the name of an Output channel in the Outputs page

- 4 Type a new name and press Enter on the computer keyboard.

 *When naming channels in the Patchbay, double-click the channel name next to the grid to edit text; press Tab on the keyboard to go to the next channel and Shift+Tab to go to the previous channel.*

## Assigning Busses to Hardware Outputs

Mains, Groups (or Variable Groups), Auxes, Matrix mixer outputs and PQ mixer outputs can be assigned to any hardware output on the system. Available output destinations include:

- Stage audio outputs
- FOH (local) audio outputs
- Pro Tools recording inputs

### To assign a bus or mixer output to a hardware output from the Patchbay:

- 1 Go to the Patchbay page and click the Outputs tab.
- 2 To the left of the channel grid, click the Mains, PQ, Mtx (Matrix), Aux or Grp (Groups) tab.



3 Click in the channel grid to assign a bus or Matrix/PQ mixer output (listed on the left) to a hardware output (listed across the top).



Assigning an output in the Patchbay Outputs page

The Patchbay Outputs page shows the name of the bus or mixer and its destination. The destination is also displayed below the channel name in the Outputs page and Patchbay Outputs page.



Output name and destination in the Patchbay Outputs page

## Routing Group Outputs to the Mains Busses

You can route Group outputs to the Main busses from the console or on-screen.

### To route a Group output to the Main busses from the ACS:

1 Press the Groups switch in the Output Fader assignment section to assign control of Group levels to the faders.

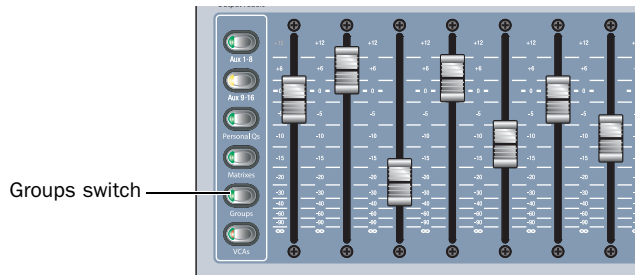

Assigning Groups to the Output faders

2 Select each Group that you want to assign to the Main busses by pressing their Select switches.

3 In the Bus Assigns section, press the L–R (left and right) or C/Mono (center/mono) switch so that it is lit.

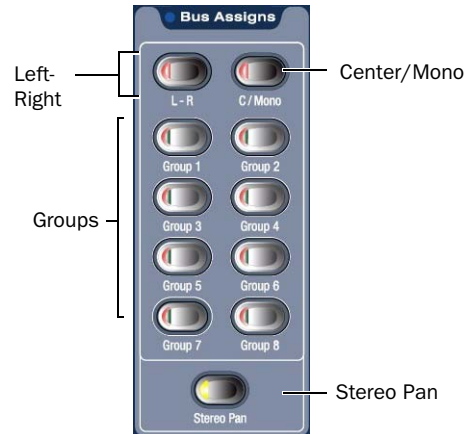

Bus Assign switches

4 Move the channel's fader to set the Group output level.

### Group Routing Indication on Output Encoders

Output encoder indicator LEDs indicate Main bus assignments as follows:

**Off** Group routing to Mains is turned off.

**Yellow** Group output is routed to the Mains L–R bus.

**Green** Group output is routed to the Mains C/M bus.

**Red** Group output is routed to both the Mains L–R bus and the Mains C/M bus.

### To route a Group output to the Main busses on-screen:

1 Go to the Outputs page and select the channel fader strip for the Group you want to route to the Main busses.

2 Click the Bus Assign buttons on-screen to toggle the bus assignment for the selected Group.



Assigning a Group output to the Main busses from the Output page

## Using Inserts on Output Busses

You can use software plug-in inserts and graphic EQ on Mains, Groups, Auxes, and Matrixes.

## Using Plug-In Inserts on Output Busses

You can insert plug-ins on Output busses directly from the Outputs page.

### To insert a plug-in on an output bus:

- 1 Go to the Outputs page and target the bus where you want to insert the plug-in.
- 2 In the Inserts section of the Outputs page, do one of the following:
  - Click one of the four Inserts pop-up menus and choose a plug-in directly from one of the Plug-In Rack submenus.
  - or –
  - Click one of the four Inserts buttons to go to the Plug-In Rack, and route the signal to the plug-in using Plug-In Rack controls.

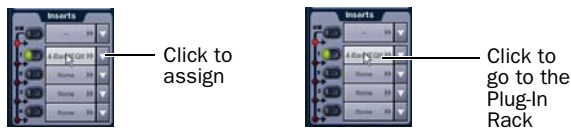

Assigning a Plug-In Insert in the Outputs page

The name of the plug-in insert appears in the on-screen Plug-In Insert button.

 For complete instructions on plug-ins, see Chapter 18, “Plug-Ins.”

## Using Hardware Inserts on Output Busses

You can insert external processors in the signal chain of Output busses. Signals from these sources are routed to and from analog or digital I/O connectors on the Mix Rack (FOH I/O) or the FOH Rack.

### Assigning Hardware Inserts to Outputs

You can assign hardware inserts to Output busses directly from the Outputs page or from the Patchbay.

#### To assign a hardware insert to a bus:

- 1 Go to the Outputs page and target the bus where you want to assign the hardware insert.
- 2 In the Inserts section of the Outputs page, do one of the following:
  - Click the Hardware Insert pop-up menu and choose an insert destination directly from the menu.
  - or –

- Click the Hardware Insert button to go to the Inserts page of the Patchbay, and assign the insert from the Patchbay.

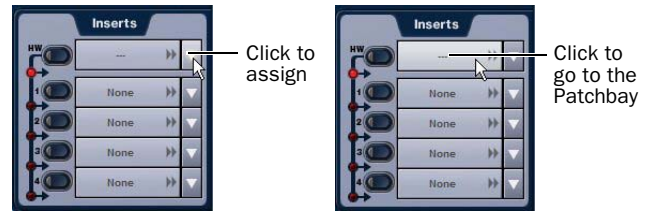

Assigning a hardware insert in the Outputs page

The name of the hardware insert destination appears in the on-screen Hardware Insert button.

### Setting the Hardware Insert Location

You can choose the location of the hardware insert in the signal path, relative to the four plug-in inserts, for each channel. A hardware insert does not need to be currently assigned to do this.

#### To set the hardware insert location:

- 1 Go to the Outputs page and select the channel where you want to set the hardware insert location.
- 2 In the Inserts section of the Outputs page, click the hardware insert indicator so that it lights red.

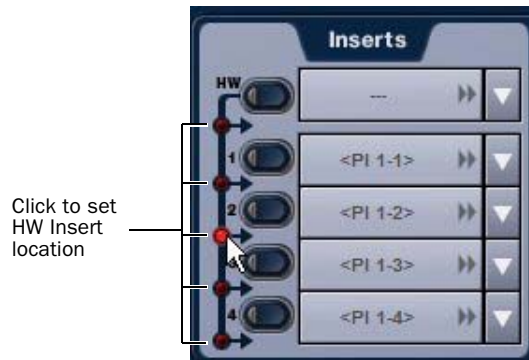

Setting a hardware insert location in the Inputs page

### Activating and Bypassing Inserts

After plug-in inserts are assigned to an Output bus, they can be activated and bypassed from the console or on-screen using the corresponding Output page controls.

#### To activate or bypass an Output bus insert:

- 1 Target the bus by pressing its Select switch.
- 2 Press any of the Plug-In switches, or click the HW In/Out button on-screen. The switch lights when the Insert is activated. (Hardware insets cannot be bypassed from the Profile console; use the on-screen control instead.)



## Inserting the Built-In Graphic EQs on Output Busses

A built-in 31-band Graphic EQ can be inserted on any of the Output bus types. A maximum of 24 Graphic EQs are available, depending on the how they are configured. For more information on configuring and using Graphic EQs, see “Graphic EQ for Outputs” on page 146.

### To insert a Graphic EQ on an Output bus:

- 1 Target the bus by pressing its Select switch.
- 2 In the Outputs page, click the 31-Band Graphic Equalizer tab.
- 3 Click the Graphic EQ pop-up menu and choose an available mono or stereo Graphic EQ. The entire Graphic EQ is displayed on-screen.



Output bus selected (Group 1)

Graphic EQ displayed in the Outputs page

## Adjusting Output Controls

Outputs are controlled from the Output faders, encoders and switches.

### Output Levels

#### To control output levels from the Output faders:

- 1 Press one of the following switches in the Output Fader assignment section:
  - Aux 1–8
  - Aux 9–16
  - Personal Qs
  - Matrixes
  - Groups
  - VCA

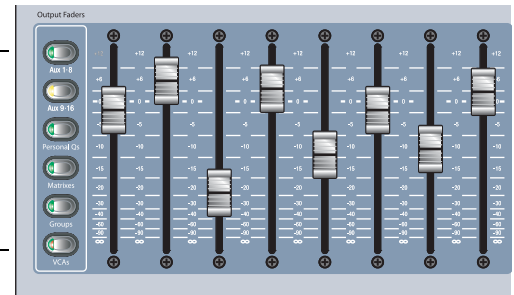

Output Fader controls

- 2 Move a fader to change the level of its assigned output.

#### To create a level offset between linked Aux bus or Variable Group bus output faders:

- 1 Press one of the following switches in the Output Fader assignment section:
  - Aux 1–8
  - Aux 9–16
  - Groups (when in Variable Groups mode)
- 2 Do one of the following:
  - Touch one linked bus output fader while moving the other.
  - Hold the Start (Win) key on the keyboard and move one linked Aux bus fader on-screen.

The offset between the faders is maintained until the offset causes a fader to reach its maximum or minimum value.

### Output Polarity (Phase) Invert

The polarity of any output bus signal can be inverted. With stereo outputs (stereo Group busses) only the left channel is inverted.

#### To invert the polarity of an output bus:

- 1 Target the bus by pressing its Select switch.
- 2 Press the polarity inversion (Ø) switch in the ACS Input section. The switch lights when the polarity is inverted.

### Output Solo

#### To control the solo status of an output bus:

- 1 Press one of the switches in the Output section.
- 2 In the Output section, press an AFL switch to toggle the solo status of the corresponding output bus.

 You can set Output banking to follow AFL selection, and vice versa. For more information on Solo bus operation, see Chapter 14, “Solo and Monitor Busses.”

## Output Mute

### To control the mute status of an output bus:

- 1 Bank the Output faders to the desired type of output:
- 2 In the Output section, press a Mute switch to toggle the mute status of the corresponding output bus.

For more information on Mute operation, see Chapter 15, “Muting and Mute Groups.”

## Output Delay

A variable delay can be applied to any of the Main busses (L, R and C/M), Aux bus outputs, and Matrix mixer outputs. (Variable Group outputs do not have this variable delay feature.)

### To apply delay to an Aux bus:

- 1 Target the Aux bus by pressing its Select switch.
- 2 Press the ACS Delay rotary encoder to engage the delay.
- 3 Adjust the delay value by turning the Delay rotary encoder.

The amount of delay available depends on the type of output, as follows:

- Up to 500 ms for Mains and Matrix mixers
- Up to 250 ms for Aux Sends

---

## Adjusting Main Bus Controls

### Mains Bus Output Levels

The Mains bus output levels are controlled from the single Mains Fader located to the right of the Output faders.

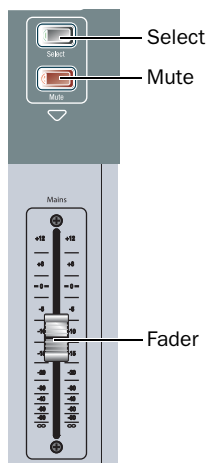

Mains Fader and controls in the Output section

The Left, Right, and Center/Mono busses can be controlled independently or in tandem. You can create an offset between any of the Main bus levels, and it will be preserved when controlling any combination of the Main busses. The offset between the busses is maintained until at least one of the busses is minimized or maximized.

### Linking Mains

You can link any of the three Mains faders for grouped-control of level and mute.

#### To link control of the Mains bus output levels:

- 1 In the Outputs page, click the on-screen channel Link buttons for any combination of Left, Right, or Center/Mono output strips to assign control of the corresponding busses to the Mains Fader.

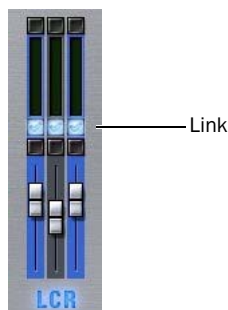

Mains fader Link selectors in the Outputs page

- 2 Move the Mains fader to change the level of the assigned busses.

### Mains Bus Mute

The mute status of the Main busses is controlled from the Mute switch located above the Mains Fader. When at least one of the Main busses is muted while others (unlinked) are not, the Mains mute switch flashes.

#### To control the mute status of the Main busses:

- 1 In the Outputs page, click the on-screen channel Link buttons for any combination of Left, Right, or Center/Mono output strips to assign control of the corresponding busses to the Mains Fader.
- 2 Press the Mute switch to toggle the mute status of the assigned busses.

## Mains Bus Delay

A variable delay (from 0 to 500 ms) can be applied to any of the Mains busses.

### To apply delay to a Main bus:

- 1 Target the Main bus where you want to apply delay by repeatedly pressing the Select switch in the Mains section, or by selecting it on-screen.
- 2 Adjust the Delay value by turning the on-screen Delay rotary encoder.

## Main Bus Center Divergence Options

When the Main busses are set to L-C-R (Left-Center-Right) mode, the Center Divergence setting determines amount of center-panned signal sent to the center output.

- ◆ When Center Divergence is set to 100%, a channel panned to center is sent to the center output only.
- ◆ When Center Divergence is set to 0%, a channel panned to center is sent equally to the left and right outputs only (phantom center).
- ◆ A Center Divergence setting between 0% and 100% sends a center-panned channel to the left, center, and right outputs with the center channel more prominent as the value increases towards 100%.

### To set Center Divergence:

- 1 Go the Options > Busses tab.
- 2 In the Panning section, click in the Center Divergence field and drag up/down to increase/decrease the value (or type in a new value).
- 3 Press Enter or Return on your keyboard to confirm the setting.

## Main Bus Automatic Delay Compensation

VENUE systems automatically compensate for delays incurred by the use of Groups and insertion of plug-ins in the signal path to the Main busses. Delays are automatically applied to signals arriving at the Main busses from multiple destinations to maintain the proper time alignment.

## Monitoring the Main Mix

You can send the Main mix (the signal present on the Main busses) to the Monitor bus for routing to the monitor bus for headphones. See “Sending the Main Mix to the Monitor Bus” on page 123.

## Direct Outputs

All input channels and output buses feature Direct Outputs.

Available destinations for Direct Outputs include:

- Stage audio outputs
- FOH audio outputs
- Pro Tools recording inputs
- Plug-ins

Each output destination may be fed by only one Direct Output signal (multiple Direct Output signals cannot be routed to a single output).

### To route a channel or bus to a Direct Output:

- 1 Target the channel or bus you want to route to a Direct Output by pressing its Select switch.
- 2 In the Directs page of the Patchbay, click the tab for the channel or bus type you are routing.
- 3 Click in the channel grid to route the channel or bus (listed on the left) to an available output (listed across the top).



Assigning a Direct Output in the Patchbay Directs page

- 4 Select the pickoff point for the Direct Output by clicking the letter to the right of the channel or bus name and choosing from the pop-up menu.



Selecting a Direct Output pickoff point in the Patchbay Directs page

- 5 In the ACS, press the Direct Output encoder so that its indicator LED stays lit (on).
- 6 Turn the Direct Out encoder to set the Direct Output level.

Up to 12 dB of gain can be added to the Direct Output signal. Direct Output level is displayed in the Selected Channel display, and controls are provided on-screen in the Patchbay, Inputs, and Outputs pages.

## Direct Output Pickoff Points

The pickoff points for the Direct Output signal are selected in the Directs page of the Patchbay. The following pickoff points are available for each type of channel or bus:

### Pickoffs for Direct Outs

Channel Type	Available Pickoff Points
Input	Top of channel Insert return Pre/post fader
FX Returns	Top of return Pre/post fader
Outputs	Top of bus Pre fader Post fader

## Configuring Direct Output Pickoff Points

### To configure the Direct Output pickoff point for Inputs:

- 1 Go to the Options page and click the Pickoffs tab.
- 2 Under Input Strip Fader Pickoff Point, click Pre-Fader or Post-Fader.

## Matrix Mixers

Eight Matrix mixers are available for sending up to eight mono mixes of input channels and busses to any available hardware output or bus-fed plug-in.

Each Matrix is a 12-in/1-out mono mixer with assignable input sources including Group busses or Aux busses, the 3 Main busses (L-C-R or L-R+M) and any of up to 8 user-selectable channels. Matrix input levels are controlled from the Output encoders when a Matrix is selected. Adjacent Matrix inputs can be linked or unlinked.

Odd/even pairs of Matrix mixers can be linked to form stereo Matrix output busses. The master output of each Matrix mixer is controlled from the Output faders.

 See Chapter 11, "Matrix and Personal Q Mixers."

## Personal Q Mixers

Eight Personal Q (PQ) mixers are available for sending up to eight discrete stereo mixes of input channels or busses to any available hardware output or bus-fed plug-in. Each PQ is a 12 x 2 mixer with assignable input sources including Group busses or Aux busses, the 3 Main busses (L-C-R or L-R+M) and any of up to 8 user-selectable channels.

Each of these PQ mixers can be remotely controllable by optional PQ Controller units, which allow adjustment of PQ mixer levels from the stage.

 If no PQ Controllers are used, the PQ mixers are still available for use as stereo Matrix mixers at the console.

PQ input levels and PQ input pan are controlled from the Output encoders. Adjacent PQ inputs can be linked or unlinked. The master output of each PQ mixer is controlled from the Output faders.

 See Chapter 11, "Matrix and Personal Q Mixers."

## Assigning and Using VCAs

VCA controls emulate the operation of traditional Voltage Controlled Amplifiers (VCAs). Up to eight VCA faders are available for remote control of input channel, FX return, or output channel fader gain.

 VCAs control level of the assigned channels only. They do not act as a summing output bus.

VCAs remotely control the fader gain of each channel assigned to the VCA fader, but do not change the position of the faders on those channels. The accumulated gain of a channel belonging to several VCAs is limited to +12 dB.

## Assigning Channels to VCAs

### To assign channels to VCAs:

- 1 Press the VCAs switch in the Output faders section.
- 2 Select the VCA you want to target for assignment.
- 3 Press the Multi-Assign switch to the right of the Output section.
- 4 Press the Select switches on the input channels, FX returns, or output channels you want to assign to the VCA.
- 5 Press the flashing Multi-Assign switch to confirm the assignment, or press the Cancel switch to cancel the assignment.

## Channel Strips Show VCA Contribution

The *effective gain* of any channel is equal to the combination of its individual channel fader, plus any (all) VCA level changes that affect that channel.

Input and output channels display the net effect of VCA level (effective gain) on-screen. This lets you keep track of what all currently assigned VCAs are doing to channels and busses at all times.

## On-Screen VCA Indication

VENUE displays effective gain as a second, transparent fader cap on-screen in the fader displays of both the Inputs and Outputs pages.

**Selected Channel** When the currently selected channel is under VCA control, the net effect of all its assigned VCAs is shown in the form of a transparent fader cap.

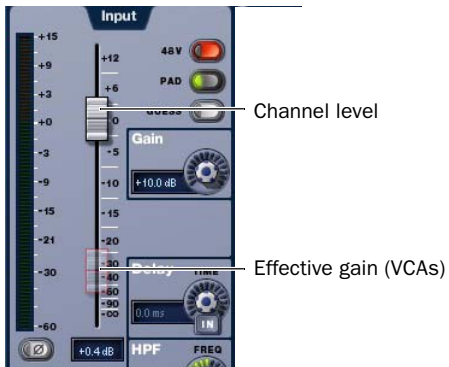

Effective gain (VCA contribution) shown on the selected channel

**Inputs and Outputs Pages** In the Inputs and Outputs pages, red “ghost” fader caps appear below the fader displays of channels that are currently assigned to one or more VCAs.



Effective gain (VCA contribution) shown in the on-screen fader displays

The opacity of the ghost caps vary with the actual VCA levels:

- Lighter caps indicate smaller amounts of VCA gain.
- Brighter caps indicate larger amounts of VCA gain.

## Turning Channel VCA Indication On and Off

By default, channel VCA indication is on. You can turn off VCA indication in the Options > Interaction page.

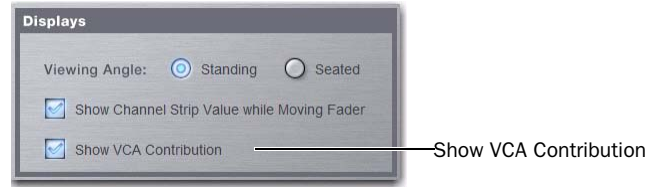

Displays settings in the Options > Interaction page.

**To turn channel VCA indication off or on:**

- 1 Go to the Options > Interaction page.
- 2 In the Displays section, click to enable (or disable) Show VCA Contribution.

## Showing VCA Members

**To view VCA membership:**

- 1 Press the VCA switch to bank the Output faders to VCAs.
- 2 Press and hold the Default (Alt) switch, then press the Multi Assign switch in the Output section. The Multi Assign switch LED lights to indicate Multi Assign mode.

VCA assignments are shown in each channel strip LCD with a flashing number (the number indicates the VCA to which each channel is assigned).

**To exit Show VCA Members mode:**

- Press the Multi Assign switch, or Cancel.

## Using VCAs

**To adjust the levels of VCA members:**

- 1 Press the VCAs switch to assign control of the VCAs to the Output faders.
- 2 Move the fader for the VCA whose members you want to adjust.

**To solo the members of a VCA:**

- Press the Solo switch on the VCA channels whose members you want to solo so that the Solo switch is lit.

Input channel solo mode (PFL or AFL) follows the current setting on the Options > Busses page.

 *Input channel solo mode (PFL or AFL) follows the current setting on the Options > Buses page.*

**To mute the members of a VCA:**

- Press the Mute switch on the VCA channels whose members you want to mute. The Mute LEDs on channels assigned to the VCA flash to indicate they are implicitly muted by the VCA.

**VCA Spill**

You can “spill” a VCA to have only its assigned channels banked to the Input section. VCA Spill lets you quickly access only those channels assigned to a specific VCA and immediately focus on those channels, without needing to search through the input fader banks.

**To spill a VCA:**

- 1 Select the VCA output fader bank.
- 2 Double-press a VCA Select switch to spill its members across the input faders.

The selected VCA Select switch LED flashes, as do the current input Bank (A-D) or FX Return (1-8) switch. Any Bank Safed channels are hidden (though their Bank Safe status is unaltered).

If the VCA contains fewer than 16 members the channels are right-justified within the input fader bank, in order to bring channels as close as possible to the center of the console. Unused channel strips are left blank and inactive.

If the VCA contains more than 16 members, only the first 16 members are shown.

**To cancel VCA Spill, do any of the following:**

- Press or double-press the Select switch on the currently spilled VCA.
- Press any Bank (A-D) switch.
- Press the FX Returns 1-8 switch.
- Press a GEQ switch.
- In the on-screen dialog, click Exit VCA Spill.

**Selecting Other VCAs While Spilled**

Selecting another VCA while spill mode is active automatically spills that VCA.



# Chapter 9: Groups

This chapter shows how to do the following:

- Configure Group busses
- Route Groups
- Adjust Group bus parameters

---

## Configuring Group Busses

The Output section has 8 available Group busses. Group outputs can be assigned to the Main Output busses, to available bus-fed plug-ins, to Matrix mixers, and to any hardware outputs on the systems.

Group busses can be globally configured to be mono or stereo as part of the Aux/Group bus configuration. See “Configuring Aux, Group, and Variable Group Busses” on page 80.

---

## Routing Inputs to Group Busses

**To route multiple channels to a single Group:**

- 1 Press the Groups switch to bank the Output faders to the Groups busses.
- 2 Press the Select switch in the Output strip for the Group (1–8) to which you want to assign channels.
- 3 Press the Multi-Assign switch near the Output encoders. The Multi Assign and output Select switches flash.
- 4 Press the Select switch on the channels you want routed to the selected Group.
- 5 Press the Multi Assign switch again to confirm the action.  
– or –
  - Select another Group to confirm the current assignment but remain in Multi Assign mode to assign channels to the newly targeted Group bus.

**To route channels to any number of Group busses:**

- 1 Target one or more channels.
- 2 In the Bus Assigns section, press any of the Group switches so that they are lit.

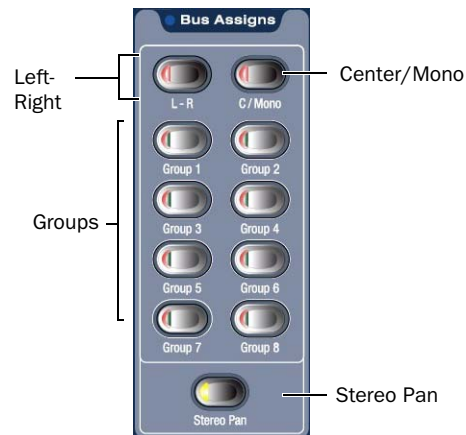

Bus Assign switches

---

## Routing Group Outputs to the Main Busses

You can route Group outputs to the Main busses from the ACS or on-screen.

**To route a Group output to the Main busses from the ACS:**

- 1 Press the Groups switch in the Output Fader assignment section to assign control of Group levels to the faders.

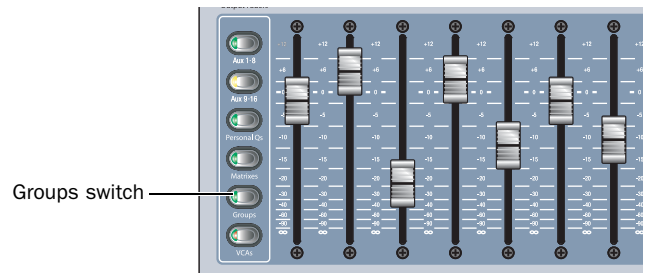

Assigning Groups to the Output faders

- 2 Select each Group that you want to assign to the Main busses by pressing their Select switches.

3 In the ACS Bus Assigns section, press the L-R (left and right) or C/Mono (center/mono) switch so that it is lit.

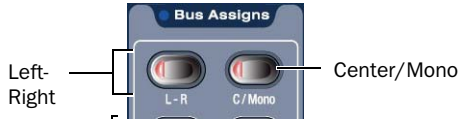

Bus Assign switches

**To route a Group output to the Main busses on-screen:**

- 1 Go to the Outputs page and select the Group you want to route to the Main busses.
- 2 Click the Bus Assign buttons on-screen to toggle the bus assignment for the selected Group.



Assigning a Group output to the Main busses from the Output page

## Managing Group Bus Assignments

To help manage Groups, the following sections explain how you can spill, view, copy (duplicate) and reset Groups and Group bus assignments.

### Group Spill

You can “spill” a Group to have only its assigned channels banked to the Input section. Group Spill lets you quickly access only those channels assigned to a specific Group and immediately focus on those channels, without needing to search through the input fader banks.

**To spill a Group:**

- 1 Select the Group output fader bank.
- 2 Double-press a Group Select switch to spill its members across the input faders.

The selected Group Select switch LED flashes, as do the current input Bank or FX Return switch. Any Bank Safed channels are hidden (though their Bank Safe status is unaltered).

If the Group contains fewer than 16 members the channels are right-justified within the input fader bank, in order to bring channels as close as possible to the center of the console. Unused channel strips are left blank and inactive.

If the Group contains more than 16 members only the first 16 members are shown.

**To cancel Group Spill, do any of the following:**

- Press or double-press the Select switch on the currently spilled Group.
- Press any Bank (A-D) switch.
- Press the FX Returns 1-8 switch.
- Press a GEQ switch.
- In the on-screen dialog, click Exit Group Spill.

### Selecting Other Groups While Spilled

Selecting another Group while spill mode is active automatically spills that Group.

### Special Cases with Spill

#### Faders

If you are touching a fader at the same time as you invoke Group Spill, that fader may be taken off-line. Let go of the fader to bring it back online.

### Viewing Group Bus Assignments

You can view Group bus assignments from the Input section of the console or from an on-screen list of Group members.

### Viewing Group Bus Assignments in the Input Section

**To view Group membership on the console:**

- 1 Press the Groups switch to bank the Output faders to Groups.
- 2 Press and hold the Default switch, then press the Multi Assign switch in the Output section.

Group numbers are shown (flashing) in each channel strip LCD; the number indicates the Group to which each channel is assigned.



## Viewing Group Bus Assignments On-Screen

When a Group bus channel is targeted on-screen, its members are shown in a list on the right side of the Outputs page.

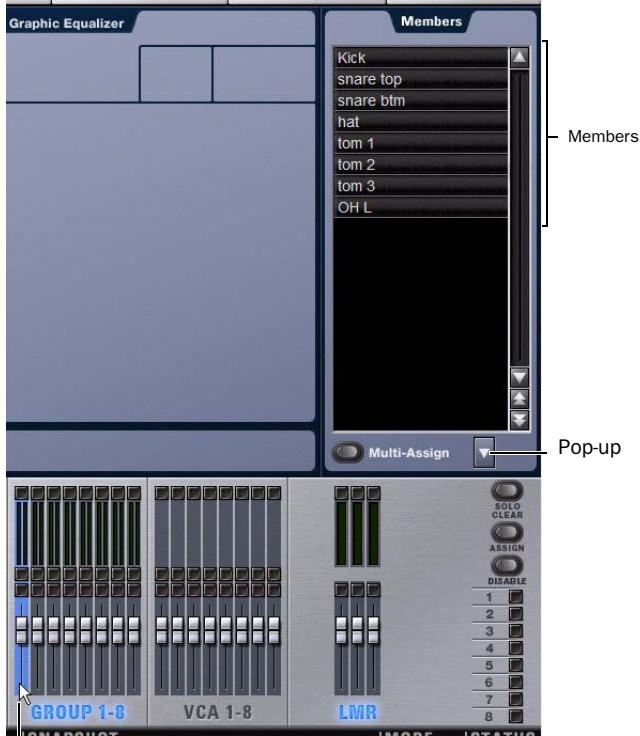

Currently selected output (Group)

Group members shown in the Outputs page

## Copying Assignments Between Groups

You can copy the current input assignments from one Group bus to another. If the Groups are stereo, assignments can be copied from other linked busses. This lets you quickly duplicate monitor mixes.

**⚠** Copying Group bus assignments overwrites all the assignments on the destination Group bus.

**To copy input assignments between Group busses:**

**1** Target the Group bus that you want to be the destination of the copied assignments by selecting its on-screen channel strip.

**2** Click the Input Assign pop-up menu at the bottom of the Members list, choose Replace With Mix From, then choose the Group whose assignments you want to copy to the currently selected bus.

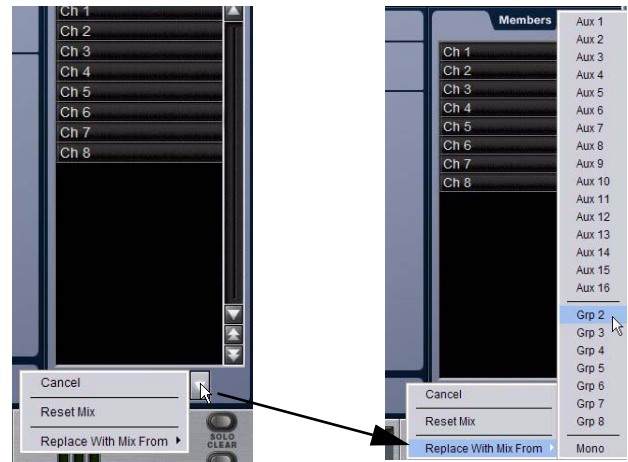

Copying input assignments between Groups

## Resetting Group Bus Assignments

You can remove input assignments from a Group on-screen.

**To remove an input assignment from a Group bus:**

**1** Select the Group bus you want to change so that its members are displayed on-screen.

**2** In the list of Group bus members, right-click the input assignment you want to remove and choose Unassign.

**To remove all input assignments from a Group bus:**

**1** Select the Group bus you want to change so that its members are displayed on-screen.

**2** Click the pop-up menu at the bottom of the Members list and choose Reset Mix.



Removing input assignments from a Group bus

---

## Group Bus Signal Flow Options

### Routing Signals to a Mono Group Bus Configuration

When configured as mono busses, the eight Groups can be fed as 8 unlinked mono busses or up to 4 linked odd/even bus pairs.

#### Unlinked Mono Busses

##### To use unlinked mono Group busses:

- 1 Make sure the Group busses are configured as mono busses. See “Configuring Aux, Group, and Variable Group Busses” on page 80.
- 2 While routing channels to Group busses, make sure the Stereo Pan switch is off.

The Group switches in the ACS Bus Assigns section light green to indicate mono operation. In this configuration, input signals are handled as follows:

**Mono Input Signals** Contributing mono signals are summed to the mono Group bus. Any pan information from mono input channels feeding the bus is ignored.

**Stereo Input Signals** Contributing stereo signals are summed to the mono Group bus with no attenuation. The balance and width information from each stereo input channel is ignored.

#### Linked Odd/Even Bus Pairs

##### To use linked mono Group bus pairs:

- 1 Make sure the Group busses are configured as mono busses. See “Configuring Aux, Group, and Variable Group Busses” on page 80.
- 2 While routing channels to Group busses, press the Stereo Pan switch so that it lights yellow.

The Group switches in the ACS Bus Assigns section and the Stereo Pan LED in the channel’s Bus Assign indicator light yellow to indicate stereo operation. In this configuration, input signals are handled as follows:

**Mono Input Signals** Contributing mono signals are panned across the linked odd/even Group bus pair. Pan information from each mono input channel determines its pan position in the bus pair.

**Stereo Input Signals** Contributing stereo signals are panned across the linked odd/even Group bus pair. Balance and width information from each stereo input channel determines its contribution to the odd and even sides of the bus pair.

### Routing Signals to a Stereo Group Bus Configuration

When configured as stereo busses, the eight Groups can be fed as 8 true stereo busses or (in Expert mode only) as 8 dual mono busses.

#### Stereo Busses

##### To use stereo Group busses:

- 1 Make sure the Group busses are configured as stereo busses. See “Configuring Aux, Group, and Variable Group Busses” on page 80.
- 2 When routing channels to any of the Group busses, make sure the Stereo Pan switch is lit yellow.



*When working with stereo Groups in Simple Mode, the Stereo Pan switch is always lit to indicate all Groups operate in true stereo.*

#### Dual Mono Busses

Dual mono busses may only be used in Expert Mode. See “Simple and Expert Operational Modes” on page 93.

---

## Adjusting Group Bus Output Controls

### Group Bus Output Levels

Group bus levels are adjusted just like other Output busses (bank to Groups, adjust the fader). For more information, see “Adjusting Output Controls” on page 83.

### Group Bus Output Pan

Group bus output pan is controlled from the Output encoders.

Groups-to-Mains assignment is displayed by the indicator LED for each Output encoder, when Groups are banked to the Output faders. The Output encoder Pan switch cycles the encoders and LCD to pan, balance and width parameters.

The pan controls adjust pan (when in mono Groups configuration) or stereo balance and width (when in stereo Groups configuration) of the Group output to the Main busses only. The Group outputs in the Patchbay are distinct left and right channels.

##### To control mono Group output pan:

- 1 Bank the Output faders to Groups.
- 2 Press the Pan switch in the Output encoder section once to assign control of Group pan to the Output encoders.
- 3 Turn a rotary encoder to adjust the pan for the corresponding mono Group.

#### To control stereo Group output balance and width:

- 1 Press the Pan switch in the Output encoder section.
- 2 Turn a rotary encoder to adjust the balance for the corresponding stereo Group.
- 3 Press the Group Pan switch in the Output Encoder assignment section an additional time to assign Group width control to the Output encoders.
- 4 Turn a rotary encoder to adjust the width for the corresponding stereo Group.

---

## Simple and Expert Operational Modes

When configuring Group busses, you can choose between two operational modes that provide different levels of flexibility: *Simple mode* and *Expert mode*.

### Setting the Operational Mode

#### To switch between Simple mode and Expert mode:

- 1 Put the system in Config mode.
- 2 Go to the Options page and click the Busses tab.
- 3 Under Stereo Group Panning Operation, select the mode you want to use (Simple or Expert).

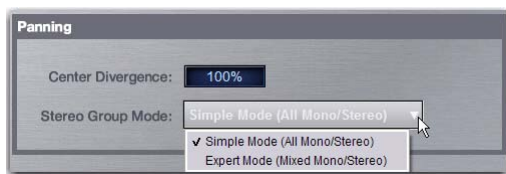

Setting the Group bus operational mode

### Working with Mono Group Busses

When configured as mono busses, Groups can operate in the following modes:

#### Simple Mode

In Simple mode, either all Groups on a channel are mono, or all Groups on a channel act as bus pairs.

#### Expert Mode

In Expert mode, any of the 4 bus pairs can be stereo linked individually while leaving the other busses as mono, on a per channel basis.

#### To set the link status of individual mono Group busses on a channel (Expert Mode only):

- 1 Make sure Stereo Group Panning is set to Expert Mode.
- 2 Select an input channel or FX return whose signal you want to send to a Group bus. To select multiple channels, use the Multi-Select switch next to the input faders.
- 3 In the Bus Assigns section, press the Stereo Pan switch. The switch flashes yellow to indicate bus link mode.
- 4 Press any of the Group switches to link or unlink the bus pairs (1–2, 3–4, 5–6, or 7–8). The Group switch pairs flash yellow to indicate stereo linked, or flash green to indicate mono.
- 5 Press the flashing Stereo Pan switch to confirm the bus link status for the selected channels.

### Working with Stereo Group Busses

When configured as stereo busses, Groups can operate in the following modes:

**Simple Mode** In Simple Mode, all 8 Group busses function only as true stereo busses.

**Expert Mode** In Expert Mode, any of the 8 stereo Group busses can be set to act as true stereo or as dual mono busses, on a per channel basis.

#### To set the link status of individual stereo Group busses for a channel (Expert Mode only):

- 1 Make sure Stereo Group Panning is set to Expert Mode.
- 2 Select an input channel or FX return whose signal you want to route to a Group bus. To select multiple channels, use the Multi-Select switch next to the input faders.
- 3 In the ACS Bus Assigns section, press the Stereo Pan switch. The switch flashes yellow to indicate bus link mode.
- 4 Press any of the Group switches (1–8) to set the corresponding bus to stereo or dual mono. The Group switches flash yellow to indicate stereo, or flash green to indicate dual mono.
- 5 Press the flashing Stereo Pan switch to confirm the bus link status for the selected channels.

#### To use dual mono Group busses (Expert Mode only):

- 1 Make sure the Group busses are configured as stereo busses. See "Configuring Aux, Group, and Variable Group Busses" on page 80.
- 2 Make sure the link status of the Group busses you want to use is set to dual mono.

When routing channels to a dual mono Group bus, the Stereo Pan switch will be off and the Group switch will light green to indicate dual mono operation.



# Chapter 10: Aux Sends and Variable Groups

This chapter explains the following Aux Sends operations:

- Configuring Aux Send busses
- Routing to Aux Sends
- Adjusting Aux Send parameters
- Managing Auxes

## Configuring Aux and Variable Group Busses

Up to 16 Aux busses are available. The number of available Aux busses is set as part of the overall Aux/Group bus configuration. (See “Configuring Aux, Group, and Variable Group Busses” on page 80.)

When the system is set to Variable Groups mode, the 8 Group busses are replaced by *Variable Group* busses, which operate in much the same way as Aux busses. When set to Variable Groups mode (Var Groups), the 16 Aux and 8 Variable Group busses provide up to 24 busses.

Auxes can be mono, or linked to form stereo pairs. Auxes and Variable Group busses can be fed by input channels and FX returns, and can be assigned to hardware outputs in the Patchbay. Aux Send level controls provide a gain range of  $-INF$  to  $+12$  dB.

## Linking Aux and Variable Group Busses for Stereo Operation

When working with Aux/Var Group busses, you can link odd/even bus pairs and pan input signals into those bus pairs.

### To link Aux or Var Group bus pairs:

- 1 Put the system into Config mode.
- 2 Go to the Options page and click the Busses tab.

- 3 Click *Edit*.



Linking bus pairs in the Options > Busses page

- 4 Click the checkboxes above any of the bus pairs to link or unlink each pair.

- 5 Click Apply.

When busses are linked, signals are handled as follows:

**Mono Input Signals** Contributing mono signals are panned across the linked odd/even bus pair.

- When the Follows Channel Pan option is off, panning of the mono signal to the bus pair is controlled by the Aux Pan control (the even-numbered send).
- When the Follows Channel Pan option is on, the pan information from each mono input channel determines its pan position in the bus pair.

**Stereo Input Signals** Contributing stereo signals are panned across the linked odd/even bus pair. Stereo width information from the input channel is applied to the bus signal.

- When the Follows Channel Pan option is off, balance of the stereo signal to the bus pair is controlled by the Aux Pan control.
- When the Follows Channel Pan option is on, the balance from each stereo input channel determines its contribution to the odd and even sides of the bus pair.

## Selecting Aux Send and Variable Group Pickoff Points

You can specify the pickoff point on input channels and FX returns channels for Aux and Var Group sends. Pickoff points are set for each bus independently. If any busses are linked, the pickoff point is set for the linked bus pair.

Each channel can be sent to an Aux or Var Group either pre- or post-fader. Pre-fade offers several choices of pickoff.

**Pre-EQ** Post-HPF and pre-EQ, Dynamics and Channel Inserts, pre-Mute, and pre-Fader. The Aux or Var Group send is not affected by the channel mute.

**Pre-Mute** Post-HPF, post-EQ, Dynamics, and Channel Inserts, pre-Mute, and pre-Fader. The Aux or Var Group send is not affected by the channel mute.

**Pre-Fader** Post-HPF, post-EQ Dynamics, and Channel Inserts, post-Mute, and pre-Fader. The Aux or Var Group send is affected by the channel mute.

### To set the Pre pickoff point for an Aux or Variable Group send:

- 1 Go to the Options page and click the Busses tab.

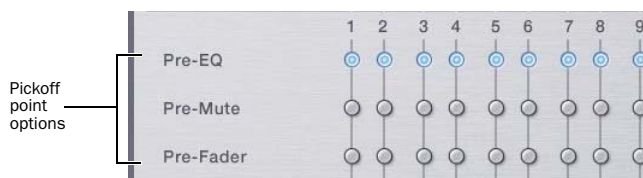

### Setting Aux bus pickoff points

- 2 Select a Pre pickoff point for any of the busses or linked bus pairs by clicking the Pre-EQ, Pre-Mute, or Pre-Fader button.

### To activate a Pre pickoff point for an Aux or Variable Group send:

- 1 Go to the Inputs page and target the channel with the pickoff point you want to activate.

- 2 Do any of the following:

- To activate an Aux Send Pre pickoff, click the corresponding Pre button in the Aux Sends section.

– or –

- To activate a Variable Group Pre pickoff, click the Var Groups button in the Bus Assign section to display Var Groups, then click the corresponding Pre button.



### Activating Pre pickoff for an Aux Send (Inputs page shown)

When the Pre button is lit, the selected Pre pickoff point is used. When the Pre button is off, the pickoff point is Post-Fader.

## Classifying Auxes for Snapshots

You can classify Aux Sends and Variable Group sends as *monitor sends* (“Mon”) or as *effects sends* (“FX”) for the purposes of scoping and safing each type separately in snapshots. See “Classifying Aux Sends” on page 200.

## Routing Inputs to Aux Busses

You can send signals from any input channel or FX return to any number of Aux Send or Variable Group busses with the input encoders, from the ACS, from the Output section, or on-screen.

### To route channels to Aux or Var Group sends using the input encoders:

- 1 To access Aux Sends on the input channel encoders, press an Encoder assign Send switch 1–2 through 15–16.

– or –

- To access Variable Groups, press the Var Groups switch in the ACS Bus Assigns section. This displays Variable Group Sends on the input encoders and the ACS Aux Send controls.

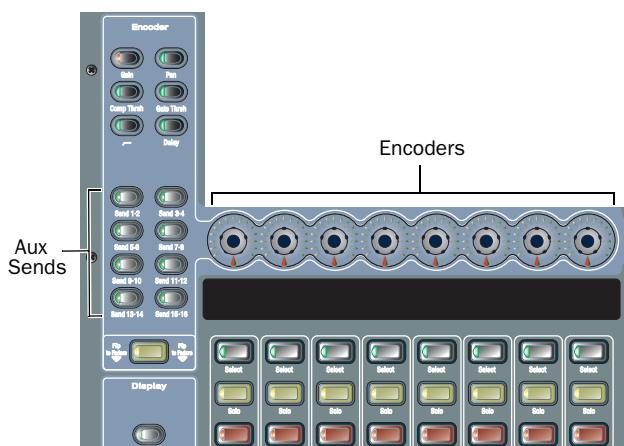

### Encoder assignment switches for input channels

- 2 For each channel you want to assign to the selected Aux Send bus, press its channel encoder so that its “On” indicator LED lights.

- The first press of an Aux Send encoder assigns level control of the odd-numbered send. The switch lights green to indicate an odd-numbered selection.
- The second press of an Aux Send encoder assigns level control of the even-numbered send. The switch lights yellow to indicate an even-numbered selection.

- 3 To set the Aux Send level, do either of the following:

- Turn the encoder on each channel.
- Press the Flip to Faders switch, then adjust the channel fader.

### To route channels to Aux Sends busses using the ACS:

- 1 Do either of the following:
  - To select a single channel, press its Select switch.
  - To select multiple channels, press Select on the first channel, hold the Multi-Select switch (located to the left of the input faders), then press the Select switches on the other channels.
- 2 In the Aux Sends section, press the Aux 1–8 or 9–16 switch to bank it to the corresponding pair of Aux Sends.
- 3 Press an Aux Sends encoder to enable that send.
- 4 Rotate the encoder to adjust that send level.

### To route channels to Aux Sends from the Output section:

- 1 Press the Auxes 1–8 or 9–16 switch to bank the Output faders to those Aux busses.
- 2 Press the Select switch in the Output strip for the Aux Send to which you want to assign channels.
- 3 Press the Multi-Assign switch near the Output encoders. The Multi Assign and output Select switches flash.
- 4 Press the Select switch on the channels you want routed to the selected Aux Send.
- 5 Press the Multi Assign switch again to confirm the action.  
– or –
  - Select another Aux Send to confirm the current assignment but remain in Multi Assign mode to assign channels to the newly targeted Aux bus.

---

## Routing Aux Busses to Outputs and Plug-Ins

Aux and Var Group busses can be routed to hardware outputs and to available bus-fed plug-ins.

### To route an Aux or Variable Group output to the Main busses from the ACS:

- 1 Press an Auxes switch (1-8 or 9-16) in the Output section to assign control of Aux levels to the Output faders.
- 2 Select each Aux that you want to assign to the Main busses by pressing their Select switches.
- 3 In the ACS Bus Assigns section, press the L–R (left and right) or C/Mono (center/mono) switch so that it is lit.
- 4 Move the channel's fader to set the Aux output level.

Like other Output busses, Aux busses also provide Direct Outs, inserts and built-in Graphic EQ capabilities. For details, see the following:

**Direct Outs** See “Direct Outputs” on page 85.

**Inserts** See “Using Inserts on Output Busses” on page 82.

**Graphic EQ** See “Inserting the Built-In Graphic EQs on Output Busses” on page 83.



---

## Adjusting Aux Send Controls

You can adjust Aux Sends from the input encoders, from the ACS, and on-screen.

### Using the Input Encoders

#### To control Aux Sends using the input encoders:

- Press an Encoder assign Send switch (1–2/15–16) to bank that Aux Send to the input encoders.

#### To turn a send on or off:

- 1 Press the input encoder for the Aux on the desired channel to toggle that send on/off.
- 2 To adjust send level, turn that encoder.

When Aux busses are linked, input signals are panned across the bus pair. Panning can be controlled from the Input encoders or from the ACS Aux Sends section.

### Controlling Aux Send and Variable Group Send Pan

When Aux busses or Variable Group busses are linked, input signals are panned across the bus pair. Panning can be controlled from the Input encoders or from the ACS Aux Sends section.

#### To control panning of Aux bus or Variable Group bus pairs from the Input section:

- 1 Do one of the following:
  - Press an Encoder assign Send switch to bank that Send to the input encoders.
  - Press the Var Groups switch in the ACS Bus Assign section to bank Variable Group Sends on the input channels.
- 2 In the Input Encoder Assignment section, press the Send switch (1–16) for the bus pair you want to pan. If you banked to Variable Groups, press a Send switch 1–8.
  - The first press of the Aux switch assigns control of the send level to the encoder. The switch lights green and the encoder display shows the odd-numbered send.
  - The second press of the Aux switch assigns control of the send pan to the encoder. The switch lights yellow and the display shows a “P” before the odd-numbered send.
- 3 With the Aux switch lit, turn the rotary encoder on each Input Channel or FX Return to adjust the send pan.

#### To control panning of Aux bus or Variable Group bus pairs from the ACS Aux Sends section:

- 1 Bank the Output faders to the Aux 1–8 or Aux 9–16 (for Auxes) or Groups (for Variable Groups).
- 1 Target the bus you want to pan by pressing its Select switch. In a linked bus pair, the ACS Aux Send controls show the following:
  - Odd-numbered rotary encoders control send level
  - Even-numbered rotary encoders control send pan
- 2 Use the Aux 1–8, Aux 9–16 and Var Groups switches to target the desired send busses. A lit switch LED indicates the current selection.
- 3 Turn the even-numbered rotary encoders in the Aux Sends section to adjust the corresponding send pan.



*You can link the ACS Aux Sends section to follow AFL, letting you immediately access send controls for Auxes and Variable Groups by soloing any Aux or Group output strip. For more information, see “Auxes/Variable Groups Follow AFL and AFL Follows Auxes/Variable Groups” on page 120.*

### Using Flip to Faders to Access Send Level and Pan Simultaneously

You can use Flip to Faders mode to spill Aux or Variable Group level control to the input faders while retaining control of Send pan from the input encoders.

#### To access Send level and pan simultaneously:

- 1 Assign the input encoders to Aux Sends or Variable Groups by doing either of the following:
  - Press a Send switch in the Input Encoder Assignment section to assign the encoders to control level for the selected send.
  - Target an Aux or Variable Group bus by selecting it in the Output section.
- 2 Press the Flip to Faders switch, at the bottom of the Input Encoder Assignment section. The input faders now control and display level for the selected send, and the encoders display and control Send pan.

### Setting Aux Send Pan to Follow Channel Pan

Panning of the input signal can be set to follow the pan or balance values of the Input Channel or FX Return feeding the Aux bus

#### To set the Aux Send pan to follow Channel pan:

- 1 Go to the Options page and click the Busses tab.
- 2 On any linked bus pairs, select the Follows Channel Pan option. This setting is applied globally to the corresponding Aux Send.



## Managing Aux Bus Assignments

### Viewing Aux and Variable Group Bus Assignments

When an Aux bus or Var Group output channel is targeted on-screen, its members are shown in a list on the right side of the Outputs page.

#### To view input assignments to an Aux or Variable Group bus:

- 1 Go to the Outputs page.
- 2 Target an Aux bus output channel by selecting its on-screen channel fader strip. Input channels routed to the selected bus are displayed in the Members list on the right side of the page.

#### To go to any assigned input channel from the Outputs page:

- Click the name of the input channel in the Members list.



Aux bus assignments shown in the Outputs page

### Resetting Aux and Variable Group Bus Assignments

You can remove input assignments from Aux/Var Group bus output channels on-screen.

#### To remove an input assignment from an Aux or Variable Group bus:

- 1 Target the bus output channel you want to change by selecting its on-screen channel strip.
- 2 In the list of member input channel assignments, right-click the input assignment to remove and choose Unassign.

#### To remove all input assignments from a bus:

- 1 Target the Aux bus output channel you want to change by selecting its on-screen channel strip.
- 2 Click the pop-up menu at the bottom of the Members list and choose Reset Mix.

## Copying Assignments Between Busses

You can copy the current input assignments from one Aux or Variable Group bus (or Mains) to another bus of either type. If the busses are linked, assignments can be copied from other linked busses. This lets you quickly duplicate monitor mixes.

**⚠** Copying bus assignments overwrites all the assignments on the destination Aux bus.

#### To copy input assignments between busses:

- 1 Target the Aux bus that you want to be the destination of the copied assignments by selecting its on-screen channel strip.
- 2 Click the Input Assign pop-up menu at the bottom of the Members list, choose Replace With Mix From, then choose the Aux/Var Group bus whose assignments you want to copy to the currently selected bus.

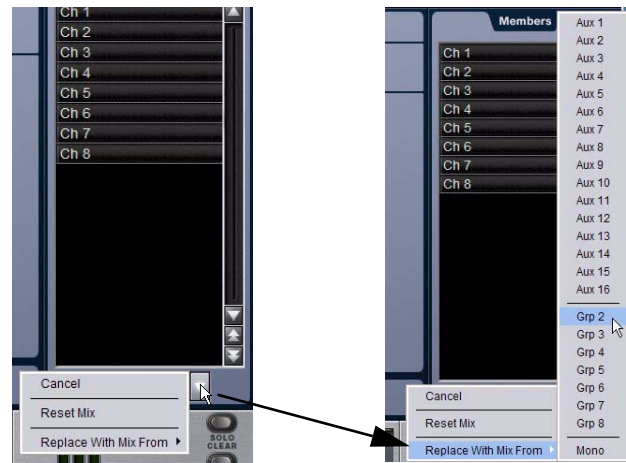

Copying input assignments between Aux busses

## Copying Mains Assignments to Aux Busses

You can copy the current Main bus assignments to Aux busses or Variable Group busses to base monitor mixes from a main mix. Assignments to the Main Left/Right busses can be copied to linked busses, and assignments to the Center/Mono bus can be copied to mono busses.

#### To copy bus assignments from the Mains to Auxes or Variable Groups:

- 1 Target the bus that you want to be the destination of the copied assignments by selecting its on-screen channel strip.
- 2 Click the Input Assign pop-up menu at the bottom of the Members list, choose Replace With Mix From, then choose the available Main bus (Left-Right or Mono) whose assignments you want to copy to the currently selected bus.

The state of the bus controls follow the state of the corresponding controls on the input channels assigned to the Mains: Channel Mute maps to Bus Send, Channel Pan maps to Bus Pan, and Channel Fader level maps to Bus Send level.



# Chapter 11: Matrix and Personal Q Mixers

The Outputs section offers 8 mono Matrix mixers and 8 stereo Personal Q (PQ) mixers for setting up alternate mixes, fill and delay feeds, and cue, monitor or press mixes.

## Matrix Mixers

Each of the 8 available Matrix mixers can receive up to 12 channels of input. Input sources can be any combination of Auxes, Groups or Mains busses, or any of the eight available Matrix User Sends. By default, each Matrix mixer has a mono output, but outputs can be linked to form stereo pairs.

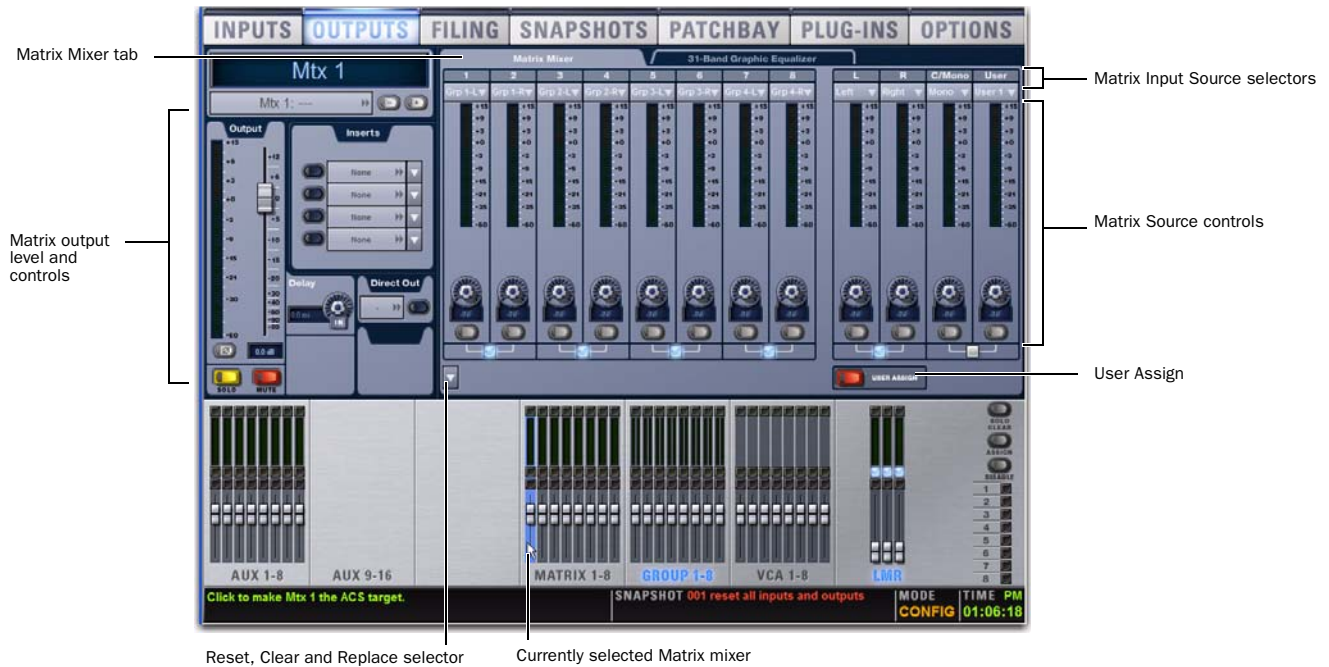

Matrix Mixer in Outputs page

## Personal Q Mixers

Each of the 8 available Personal Q (“PQ”) mixers can receive up to 12 channels of input. Input sources can be any combination of Auxes, Groups or Mains busses, or any of the eight available PQ User Sends. Each Personal Q mixer has a stereo output.

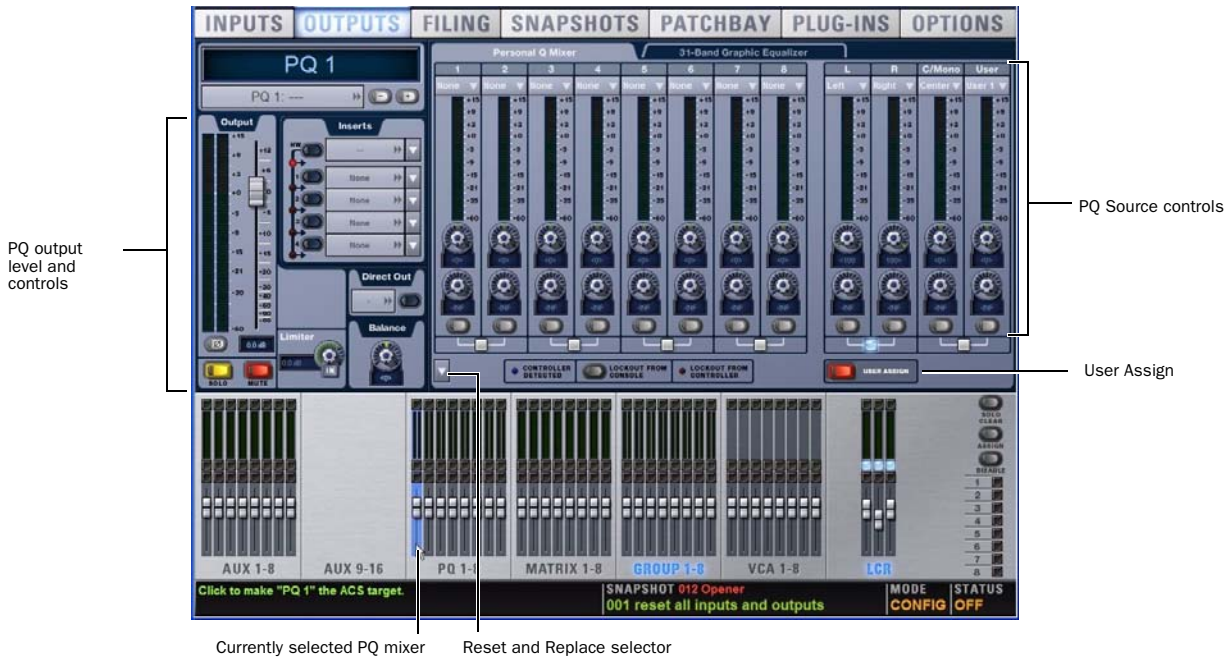

Personal Q Mixer in Outputs page

### Personal Q Controller System (Optional)

With the optional Personal Q Controller system, performers can adjust the controls in the Personal Q mixer from a remote location. See the *VENUE Personal Q Guide* for details.

 *If no PQ Controllers are used, the PQ mixers are still available for use as stereo Matrix mixers controllable from the console.*

## Configuring Matrix and PQ Mixers

The 12 Inputs for each Matrix and PQ mixer can be any combination of these 35 potential sources:

- 24 shared Aux and Group sources
- 3 Mains sources (LCR or LR+M)
- 8 User Input sources

User Inputs can be input channels, FX Returns, physical stage audio or FOH audio inputs, or inputs from Pro Tools playback options. In addition:

- One or more of the 8 available user inputs can be sent to one or more Matrix or PQ mixers.
- Input source assignment and user input assignment can be stored on a per-snapshot basis.
- The input sources for Matrix and PQ mixers are configured as Pre- or Post-Fader in the Pickoffs tab of the Options page.
- Input labels (1–8, Left, Right, C/Mono and User) are only intended as a guide. In use, any input source can be assigned to any mixer input (for example, Left doesn't always have to be assigned to the Left input of a mixer).

## Configuring Aux, Group and Mains Pickoffs

**To configure Auxes, Groups, and Mains pickoffs for the Matrix and PQ mixers:**

- 1 Put the system in Config mode.

 *Configuring pickoff points may cause a momentary loss of audio, and therefore cannot be changed in Show mode.*

- 2 Go to the Options page and click the Pickoffs tab.
- 3 Under Matrix and PQ Sources, configure Aux, Groups and Mains (LCR or LR+M) as pre- or post-fader.

## Linking and Unlinking Pairs to form Stereo Matrix Outputs

The eight mono Matrix mixers can be linked in odd/even pairs to form up to four stereo-linked pairs of matrix outputs. A combination of mono and stereo-linked Matrix mixers is possible. Odd-even matrix pairs are linked and unlinked using on-screen controls in the Options > Busses page.

 *Linking Matrixes is accomplished using the same Edit and Apply methods used for stereo linking Auxes.*

**To stereo link Matrixes:**

- 1 Put the system into Config mode.
- 2 Go to the Options > Busses page.
- 3 In the Matrix section, click Edit.
- 4 Click to enable the Link between any two adjacent (odd/even) Matrixes.
- 5 Click Apply. (Click Cancel to exit Edit mode without changes.)

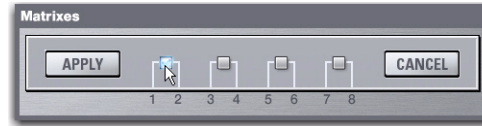

*Editing the link status of a Matrix pair in the Options > Busses page.*

When a matrix pair is linked, the even-numbered channel inherits all parameter settings of the odd-numbered channel.

The matrix mixer changes to a stereo matrix mixer:

- A Pan control is added to each matrix mixer input source.
- All input sources are panned center upon linking.

Plug-in assignments to the formerly mono matrix channels are lost, including all snapshot references.

## Unlinking Matrixes

**To unlink a pair of Matrixes:**

- 1 Put the system into Config mode.
- 2 Go to the Options > Busses page.
- 3 Click *Edit* in the Matrix section.
- 4 Click to unlink the desired Matrixes.
- 5 Click Apply.

When a Matrix pair is unlinked the even-numbered channel again inherits all parameter settings of the odd-numbered channel.

Pre-existing plug-in and GEQ routing may be affected when the matrix link state is changed. An alert dialog warning of data loss is shown prior to performing the link or unlink operation. Click OK to complete the link operation, or click Cancel to cancel without changes.

## Snapshots

All matrix settings, including Pan but excluding the stereo link status, are stored and recalled with snapshots. The stereo link status of Matrix masters is not snapshottable.

## Compatibility

Show files created in previous versions of software preserve all mono matrix settings in working memory and snapshots. Loading a Show file containing stereo-linked Matrixes in a previous version of software preserves all data except Matrix master link status.

## Settings

You can copy and paste settings between mono and stereo Matrixes, and use the Replace with Mix command, by right-clicking on the Matrix and choosing Copy, Paste, or Replace with Mix from the menu.

## Copy and Paste

Copy/paste only applies to master strip settings (fader, mute, polarity, delay, direct out). Mix parameters and mix sources are handled separately.

## Replace

You can use the right-click menu to Replace mixer settings between mono and stereo Matrixes.

From	To	Result
Mono	Mono	All mix parameters and mix sources applied
Mono	Stereo	All mix parameters and mix sources applied; Pans default to center
Stereo	Stereo	All mix parameters and mix sources applied
Stereo	Mono	All mix parameters and mix sources except pan applied

## Linking and Unlinking Adjacent Matrix Inputs

Adjacent inputs to Matrix mixers can be linked or unlinked on a per input pair basis. Link status can be specified on a per Matrix basis (for example, inputs 1 and 2 can be linked for Matrix 1, but unlinked for Matrix 2). This gives you the ability to control inputs as either a stereo-linked pair or as independent mono inputs.

- When linked, level and source on/off controls are linked.
- When unlinked, discrete level and on/off controls affect each individual channel.

Stereo inputs (such as stereo groups, Mains LR, and stereo-linked auxes) are linked by default, such as after a Clear Console operation. Adjacent inputs can be linked or unlinked at any time, in Config or Show mode.

### To link or unlink inputs to Matrix mixers:

- 1 Go to the Outputs page, and click to display the Matrix mixer.
- 2 Click the checkboxes below any adjacent inputs to link or unlink them. A check mark in the checkbox indicates a linked input source; an empty checkbox indicates unlinked sources.

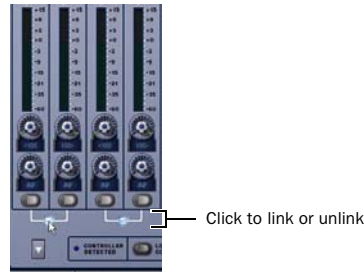

Link controls in the Outputs page

## Relinking and Offsets

When inputs are relinked, their level and on/off state will change as follows:

**Level** Each channel maintains any offset between the two channels. This offset is not maintained if both linked controls are adjusted beyond their maximum or minimum.

**On/Off** Each channel maintains its discrete on/off state at the time the sources are relinked. For example, if one channel is on and the other is off the stereo input will maintain these settings after relinking, thus providing a stereo source with one channel on, and the other off. Toggling one channel from Off to On results in both channels switching On; toggling one of the linked channels from On to Off results in both channels switching Off.



## Configuring User Inputs

You can assign up to eight User Inputs to be available globally to the Matrix mixers and, separately, up to eight User Inputs to be available globally to the PQ mixers.

Any of the eight User Inputs defined for the Matrix or PQ can be assigned to any mixer input. User Inputs are assigned from the User Assign panel of the Matrix or PQ main page.

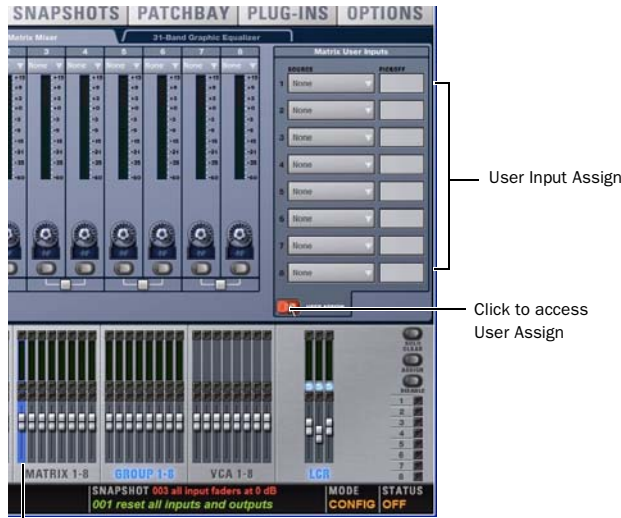

Currently selected Matrix mixer

User Input panel showing assignments for a Matrix mixer

### To configure the User Inputs for a Matrix or PQ mixer:

- 1 Go to the Outputs page and click a Matrix or PQ mixer to navigate to that mixer page.
- 2 Click the User Assign button to display the User Assign panel.
- 3 For any of the eight available User Inputs, click the on-screen Source pop-up menu and select an available source. Choices include Channels, FX Returns, Stage and FOH audio sources, and Pro Tools record/playback options (if any).

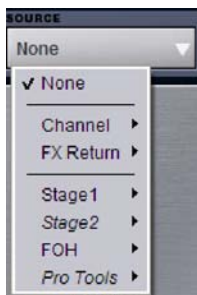

Choosing a User Assign source for a Matrix mixer

- 4 For any assigned User Inputs, click the Pickoff pop-up menu and choose the desired pickoff for that User Input source. Choices include Top of Channel, Insert Return, and Pre/Post-Fader (for Input Channels) or Top of FX Return and Pre/Post-Fader (for FX Returns).

 *The Input Channel Fader Pickoff setting on the Options > Pickoffs page determines globally whether the fader pickoff points are pre- or post-fader.*

- 5 Click the User Assign button again to return to the main Matrix screen.

## Assigning Input Sources

### To assign input sources to a Matrix or PQ mixer:

- 1 Go to the Outputs page and click to select a Matrix or PQ mixer.
- 2 Click the Input Source selector at the top of each Matrix or PQ channel and select the desired input source. Choices include Auxes, Groups, Mains and any of the 8 available User Inputs.

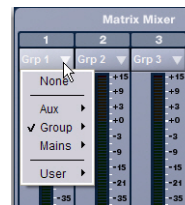

Choosing an Input Source for a mixer

 *To use Input or FX Return channels in a Matrix or PQ mixer, assign them as User Inputs, then assign those User Inputs as input sources.*

### Assigning Sources to Multiple Mixers

You can select multiple Matrix and/or PQ mixers simultaneously and assign sources to all selected mixers at the same time.

### To assign input sources to more than one Matrix mixer, or more than one PQ mixer, at a time:

- 1 Go to the Outputs page and use Multi-Select (or the Shift key) to select two or more Matrix mixers, or two or more PQ mixers, in the fader display at the bottom of the screen.
- 2 Click the Source selector at the top of a mixer channel (1–8, Left, Right, C/Mono, or User) and select the desired source.

## Adjusting Matrix and PQ Mixer Input Controls

### Matrix and PQ Mixer Input Levels

The levels for the first eight input sources (or “sends”) of a Matrix or PQ mixer are controlled by the Output Encoders.

The eight Output encoders control the input levels of the currently selected Matrix or PQ mixer input sources.

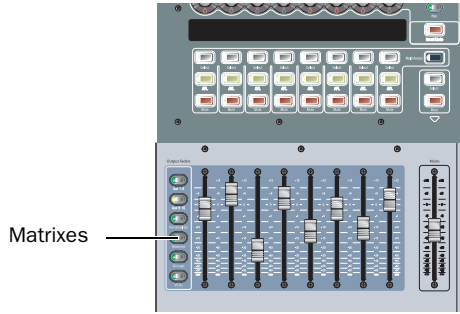

Banking Matrix mixers to the Output faders

#### To control mixer input source (“send”) levels on the console:

- 1 Press the Matrixes switch or the Personal Qs switch in the Output fader assign section.
- 2 Press a Select switch for a Matrix or PQ to select that mixer and view its inputs. Input parameters are shown on the top row of the Output LCD. Input source levels are controlled by the encoders, and output levels are controlled by the faders.
- 3 Press the encoder to turn that mixer input source on or off.
- 4 Turn the Output encoders 1–8 to set the level for the first eight input sources assigned to the currently selected Matrix or PQ mixer.
- 5 To adjust source inputs 9–12, press the Next Page switch to bank those sources to Output Encoders 5–8. To return to sources 1–8, press the Prev Page switch.

### Matrix and PQ Mixer Input Pan

The Matrix and PQ mixer input pan controls adjust the panning of each mixer input across the stereo outputs of either a linked stereo Matrix mixer or PQ mixer (PQ mixers are always stereo).

#### To control Matrix send pan:

- 1 Press the Matrixes switch in the Output fader assign section.
- 2 Press an Output channel Select switch to select a Matrix.
- 3 Press the Pan switch located below the Prev Page and Next Page switches.
- 4 Adjust the Output Encoder 1–8 to adjust pan on Matrix inputs 1–8. To access inputs 9–12 for the current mixer, press the Next Page switch.

## Resetting Matrix and PQ Mixer Input Controls

You can reset level, pan and stereo link settings for any Matrix or PQ mixer. Input source assignments persist.

#### To reset a Matrix or PQ mixer parameter to its default value:

- 1 Select one or more Matrix or PQ mixers you want to change.
- 2 Right-click the encoder on-screen and choose Reset.

#### To reset all Matrix or PQ mixer parameters to their default values:

- 1 Select one or more Matrix or PQ mixers you want to change.
- 2 Click the pop-up menu at the bottom of the mixer area and choose Reset Mix.



Resetting a mix

## Clearing Matrix and PQ Mixer Settings

You can clear mixer input assignments to quickly set all the input sources to None.

#### To clear Matrix or PQ input assignments:

- 1 Select one or more Matrix or PQ mixers you want to clear.
- 2 Click the pop-up menu at the bottom of the mixer area and choose Clear Mix Sources.

## Copying Matrix and PQ Mixer Input Settings

You can copy mixer settings from one Matrix or PQ mixer to another mixer of the same type. This lets you quickly duplicate monitor mixes or other signal feeds.

**⚠** Copying mixer settings overwrites all the settings on the destination mixer.

#### To copy settings between mixers:

- 1 Select the Matrix or PQ mixer that you want to be the destination of the copied settings so that it is displayed on-screen.
- 2 Click the pop-up menu at the bottom of the mixer area, choose Replace With Mix and Mix Sources From.
- 3 Choose the Mtx (Matrix mixer) or PQ from the sub-menu whose settings you want to copy to the current mixer.



---

## Adjusting Matrix and PQ Mixer Output Controls

### Matrix and PQ Mixer Output Levels

Matrix and PQ output levels are controlled by the Output faders.

#### To control mixer output levels:

- 1 Press the Matrixes or PQ switch to bank Matrix or PQ mixers to the Output faders.
- 2 Adjust the fader corresponding to the output level you want to change.

### PQ Mixer Output Limiter

A limiter can be applied to the output of PQ mixers. PQ output limiter controls appear on-screen only. (Matrix mixers do not have output limiters.)

#### To use a limiter on the output of a PQ mixer:

- 1 Go to the Outputs page.
- 2 Select a PQ channel to display the mixer you want to configure.
- 3 Click the on-screen Limiter In button to engage the limiter.
- 4 Drag the on-screen Limiter knob to set the limiter threshold.

### Stereo-Linked Matrix and PQ Mixer Output Balance

PQ Mixers and stereo-linked Matrix mixers provide a balance control for controlling the balance of the mixer output signal across its stereo outputs. (Mono Matrix mixers have mono outputs, so they do not have Balance controls.)

Use the on-screen Balance encoder in the Outputs page of all Matrix or PQ mixers if you need to balance levels.

#### To control Matrix or PQ mixer output balance:

- 1 Target the stereo-linked Matrix or PQ mixer output channel by pressing its Select switch in the Output Faders section.
- 2 Click and adjust the on-screen Balance encoder in the Outputs page for the targeted PQ mixer.

### Matrix Mixer Output Delay

A variable delay (0–500 ms) can be applied to the output of Matrix mixers. For instructions, see “Output Delay” on page 84.

## Delay Compensation with Matrix and PQ Mixers

VENUE automatically compensates for the delay offsets that can arise when combining different signal paths within a Matrix or PQ mixer.

#### Additional Information about Delay Compensation

- The overall latency through a Matrix or PQ mixer is determined by the path with the highest latency.
- All inputs within a Matrix or PQ mix are guaranteed to be phase accurate, but mixes are not necessarily aligned to each other. This ensures that all mixes are not penalized in the case of one or more exceptionally high-latency signal paths.
- Delay compensation only accounts for a channel’s post-insert pickoff. Channels that feed User Inputs and Auxes (pre-insert) will not be fully compensated for.

 See also “Settings for Delay Compensation” on page 61.

---

## Snapshot Data and Parameters for Matrix Mixers

Snapshots can store and recall all source assignments of each Matrix and PQ mixer when the MTX (Matrix) or PQ data type is scoped. In addition, all User Input assignments are stored, letting you reconfigure Matrix or PQ mixers and User Input assignments on a per snapshot basis, if desired.

The following table describes what can be stored and recalled in each snapshot when the MTX and PQ data type is scoped.

Table 12. Snapshot data types and parameters for Matrix and PQ

Snapshot Data Type	Included Parameters (for Each Scoped Channel Strip)
MTX	Mixer Input Sources, User Input Assignments (global to all Matrixes), and pickoffs; Mixer Input level, Mixer Input on/off state and Mixer <i>Input</i> Link state
PQ	Mixer Input Sources, User Input Assignments (global to all PQs) and pickoffs; Mixer input level, pan, and on/off state, Mixer Input Link state, Limiter threshold and Limiter in/out

 You cannot snapshot link state of Matrix outputs.

The Recall Safe tab of the Snapshots page provides two data “Mix” data types that let you discretely “safe” source and/or user input assignments to prevent them from being changed with a snapshot recall.

For complete information on VENUE snapshots, see Chapter 21, “Snapshots.”

---

## Working with a PQ Controller

When an optional Personal Q remote control system is connected to a VENUE system, it can be used to adjust the controls in the Personal Q mixers from a remote location.

For complete instructions on connecting and using PQ Controllers, refer to the *Personal Q Controller Guide*, included with the PQ Controller system.

### Controller Detection

When a PQ Controller is detected, the Controller Detected indicator lights in the corresponding Personal Q mixer on-screen window.



*PQ Controller Detected indicator in PQ mixer*

### Controller Lockout

**Lockout From Console** The PQ Controller can be locked out by clicking the on-screen Lockout From Console button in any of the PQ mixers. When this Lockout button is engaged, the PQ Controller cannot adjust PQ mixer controls. The performer using the PQ Controller cannot override this lockout from the controller.

**Lockout From Controller** Users can lock their PQ Controllers to prevent inadvertent changes to controller settings. When this is done, the on-screen Lockout From Controller indicator lights in the corresponding PQ mixer. This function does not lock out control of the PQ mixer from the console.

### Calling the Console Operator from the PQ Controller

**To call the console operator from a Personal Q Controller:**

- Press the Master Volume encoder knob.

A call message appears on the Profile console display that identifies which PQ Controller is calling. The Call LED on the PQ Controller flashes until the message is cleared from the console display.

# Chapter 12: Patchbay

## Accessing the Patchbay

### To show the Patchbay screen:

- Press the Patchbay switch, located in the View Modes section, or click the Patchbay tab on-screen.

### To jump to the Patchbay from the Inputs and Outputs screens:

- Click on the channel routing indicator, right below the channel name display. The screen automatically jumps to the corresponding Patchbay screen (whether an input, output, or bus).



Jump to Patchbay

## Overview of the Patchbay

The Patchbay screen lets you patch hardware I/O to input and output channels.

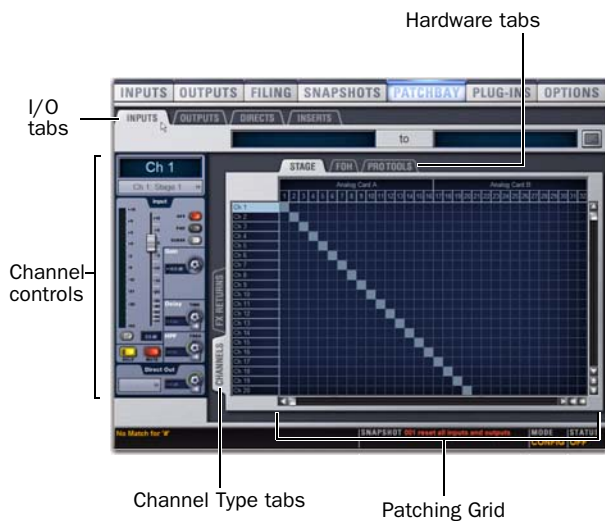

Patchbay page (Inputs tab shown)

The main tools and sections of the Patchbay screen are the following:

### Tabs

The Patchbay is navigated using the following tabs.

#### I/O Tabs

Click to display and patch Inputs, Outputs, or Directs (Direct Outputs). Other options in the Patchbay screen change to reflect the currently selected I/O tab.

#### Channel Type Tabs

Click these tabs to select and display specific types of channels, as available for the currently selected I/O. The following table shows the available Channel Types for the current I/O.

I/O tab	Channel Types available
Inputs	Channels, FX Returns
Outputs	Groups, Auxes, Matrix, PQ, Mains
Directs	Channels, FX Returns, Outputs
Inserts	Channels, FX Returns, Outputs

#### Hardware Tabs

Click these tabs to display the hardware inputs and outputs available for the current I/O and Channel Type. These represent the physical inputs and outputs of the system.

Choices include Stage audio inputs and outputs (Mix Rack or Stage Rack), FOH (local) inputs and outputs (Mix Rack or FOH Rack), and Pro Tools playback/record option inputs and outputs, if any. Available hardware inputs and outputs are based on channel type selection, system configuration and hardware device status. See “Unavailable I/O” on page 110.

## Patching Grid

The Patching Grid shows hardware I/O across the top, and VENUE channels down the left side. The available channel tabs and choices are determined by the currently selected I/O tab and Channel type(s). The grid squares represent patch points between hardware I/O and VENUE mixing channels.

By default, hardware inputs are routed in a 1-to-1 pattern to input channels. For example, Stage inputs 1–48 appear on Input Channels 1–16 (Bank A), 17–32 (Bank B) and so on.

## Channel Controls

These controls mirror the controls for the currently selected channel. For example, when showing Inputs, the Channel controls let you adjust input gain, polarity, phantom power, HPF, Direct Out, and basic level without leaving the Patchbay.

## Channel Direct Outs

The channel area in the Patchbay provides access to Direct Out controls.

### To adjust Direct Output level from the Patchbay:

- 1 In the Patching Grid, patch the channel Direct Out to an available output.
- 2 In the channel controls, adjust the on-screen Direct Output encoder.



Adjusting Direct Output level from the Patchbay

## Visual Indicators and Displays

The Patchbay uses the following visual conventions in all its pages and tabs.

### Unavailable I/O

The Patchbay shows hardware tabs for all possible configurations. The Patchbay indicates I/O that is offline or unavailable by graying out the columns beneath that device.

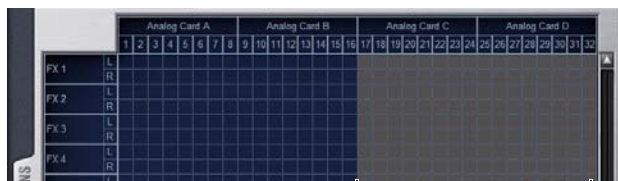

Unavailable I/O

Unavailable I/O (grayed columns)

Unavailable hardware I/O appear grayed out in the patchbay and italicized in all routing pop-up lists. It is possible to make assignments to unavailable hardware I/O.

The VENUE Standalone software provides additional display options for hardware I/O (including unavailable I/O).

 See Chapter 24, “Using the Standalone Software.”

## Assigned I/O

When a hardware connection is assigned, its connection is dimmed in all Patchbay screens. This lets you see which hardware connections are in use without having to switch back and forth between Patchbay screens. You can also use the dimmed column number indicator to jump to the Patchbay tab for the existing assignment (for more information, see “Shortcut for Locating Assignments” on page 113).

## Text Display of Patch Source and Destination

Above the grid tabs are “from” and “to” text display fields that display the full text names of hardware I/O and channels.

### To view full names of a patch source and destination:

- Place the cursor over a Channel Name.

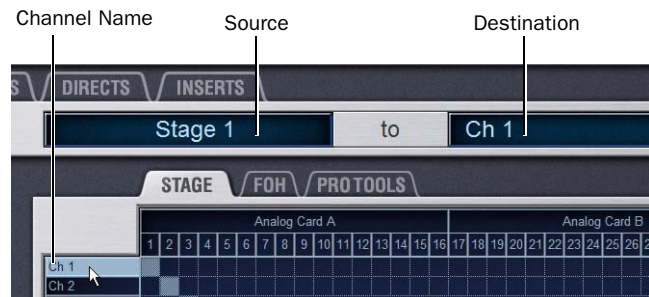

Channel source and destination display

If the channel is already routed, its source and destination assignments appear directly above the Patching Grid. An asterisk at the end of a destination name indicates a multiple output assignment. See “Multiple Input and Output Assignments in the Patchbay” on page 112.

## Naming Channels from the Patchbay

Channel names can be changed from the Patchbay. Channel names can be up to 32 characters in length. When displayed on the console, names are abbreviated to fit the display.

### To name or rename a channel from the Patchbay:

- 1 Double-click the channel name.
- 2 Type a new name and press Enter on your keyboard.

 When naming channels in the Patchbay, press Tab on the keyboard to go to the next channel and Shift+Tab to go to the previous channel.

## Type Text Search

Type Text search lets you use the keyboard for fast navigation to a channel. You can enter the first characters of a channel name or the absolute channel number to target that channel on the ACS.

### To search for and select a channel:

1 Type the first few letters, full name, or channel number of the channel. For example, type “s” to go to the first channel beginning with the letter s (such as *Snare*).

2 Press the Tab key to cycle through and select any other channels beginning with that letter (such as *Snare Top*, *Snare Bottom*, or *Strings*).

 *Avoid giving channels names that begin with numbers different from the absolute channel number. When you type a number, VENUE navigates to absolute channel numbers regardless of the channel name.*

---

## Navigating the Patchbay

### Navigating to Channel Types

The Patchbay uses multiple tabs to access different hardware I/O and channel types. For example, the Inputs screen provides Channels and FX Returns tabs for you to patch these different channel types independently.

### Examples

#### To show Inputs:

- Go to the Patchbay page and click the Inputs tab.

#### To show a specific type of Input in the Patching grid:

- In the Patchbay page, click the Channels tab, or the FX Returns tab. Shift-Click to select and show multiple types at once.

#### To navigate to a different hardware source:

- Click the appropriate Hardware tab across the top of the Patching Grid.

### Scrolling in the Patchbay

#### To scroll through the channel list (vertically):

- Move the cursor over a channel name at the left of the Patching Grid, then press the Up or Down Arrow keys on the keyboard.

#### To scroll through the hardware I/O list (horizontally):

- Move the cursor over a hardware I/O channel at the top of the Patching Grid, then press the Left or Right Arrow keys on the keyboard.

#### To scroll the Patching Grid, do one of the following:

- Click the up/down or left/right Patching Grid scroll arrows to move square by square.
- Click the up or down Patching Grid double arrows to move screen by screen.
- Right-click in the Patching Grid and drag in any direction.



Scrolling the Patching Grid by right-clicking and dragging

---

## Assigning Channels in the Patchbay

### To assign channels in the Patchbay:

- Go to a Patchbay page by clicking the appropriate I/O tab, Channel Type tab, and Hardware tab.
- Place the cursor over the Patching Grid. The cursor changes to a crosshair, and lines extend above and to the left of the cursor location to identify the column and row.
- Click in the row for the channel and in the column for the hardware I/O source.



Routing a hardware input to an Input Channel

- Click and drag vertically, horizontally, or at an angle to assign multiple patch points in a single action.
- Repeat as needed.

### Patchbay Click and Drag

You can quickly select a range of crosspoints in the Patchbay grid in one operation with a left-click and drag of the cursor. You can click and drag horizontally, vertically, and at 45-degree angles in any direction.

 *You cannot undo changes to the Patchbay grid.*

### To use click and drag in the Patchbay grid:

- Left-click on the crosspoint defining the start of the range.



2 Continue to hold the left-click button, then drag horizontally (to populate a row), vertically (to populate a column), or horizontally and vertically (a 45 degree angle).

3 Release the left-click button when the destination crosspoint is reached. All crosspoints along the path are filled in.

The destination crosspoint sets the targeted channel. If the new assignments steal any previous assignments, a warning dialog will ask you to confirm or cancel the reassignment.

### Using the Arrow Keys to Assign Channels

You can use the Arrow keys to assign routing.

#### To assign channels using the Arrow Keys on the keyboard:

- 1 Place the cursor over the Patching Grid so that the cursor changes to the crosshair.
- 2 Press the Left or Right Arrow keys to move the crosshair to the next or previous hardware I/O column; press the Down or Up Arrow keys to move the cursor to the next or previous channel.
- 3 When the crosshair is over the correct square in the grid, press Enter to assign the patch.

### Multiple Input and Output Assignments in the Patchbay

Input sources can be assigned to multiple Input Channels in the Patchbay. Output busses can be assigned to multiple hardware outputs.

Stage inputs assigned to multiple channels share a common preamp gain. Adjusting one channel's gain automatically adjusts all other channels. All other channel functions (such as EQ, dynamics, and panning) remain independent, making it convenient to have a channel appear on one input strip to bus and process it for the house mix, and on another input strip with different processing for monitor mixing.

Using multi-assigned inputs requires additional input channels be available in the current System Configuration. If you are using all available stage inputs, you must increase the number of Input Channels in the Options > System page. (To learn how to configure the number of Input Channels, see "System Configuration Settings" on page 58.)

 *On VENUE Mix Rack systems, choosing the 64 channel setting gives you additional input processing channels beyond the number of hardware inputs (48). Use this setting to be able to multi-assign inputs to input processing channels.*

#### To assign a hardware input source to multiple Input Channels or FX Returns:

- 1 Go to the appropriate Input tab in the Patchbay.
- 2 Click in the Patching Grid to assign the source to the first Input Channel or FX Return.

3 Click additional grid squares in the same column to assign the source to additional channels. The selected hardware input is routed to each of the assigned Input Channels or FX Returns.

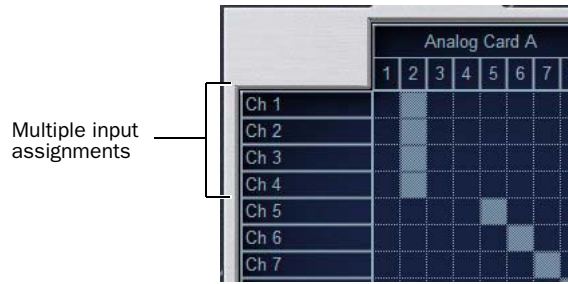

A hardware input routed to multiple Input Channels

#### To assign an Output bus to multiple hardware outputs:

- 1 Go to the appropriate Output tab in the Patchbay.
- 2 Click in the Patching Grid to assign the Output bus to the first hardware output.
- 3 Click additional grid squares in the same row to assign the same Output bus to additional hardware outputs. An asterisk (\*) appears at the end of the displayed destination to indicate the multiple routing.

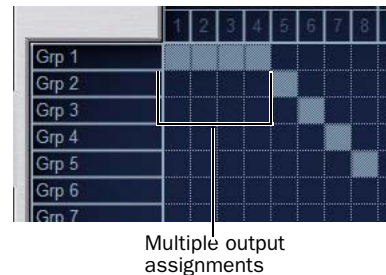

An Output bus assigned to multiple hardware outputs

### Choosing the Digital Source (AES or ADAT)

If your system includes a DSI digital input card, do the following to specify the digital source.

#### To configure a digital input for AES or ADAT:

- 1 In the Patchbay, route a DSI or other digital input to an input channel.
- 2 Click the Inputs tab and navigate to the input channel being fed from the DSI input.
- 3 Click the ADAT button on-screen, in the channel Input controls section. When lit, ADAT input is active; when unlit, AES input is active. The corresponding channel's Source LED on the Stage Rack DSI Card lights to indicate AES or ADAT.

## Warning when Stealing Inputs or Outputs in the Patchbay

The Patchbay indicates hardware outputs that are already in use by dimming the column number for that physical output. In addition, a dialog is shown if the patch will steal a hardware input or output that is already in use, asking you to confirm or cancel the reassignment.

**To confirm a reassignment, do one of the following:**

- Click Assign when prompted to confirm the reassignment.  
– or –
- Click again on the same patch point.

**To cancel a reassignment, do either of the following:**

- Click Cancel to leave the patchpoint unchanged.
- Click any other point in the grid (the Patchbay grid remains active, even when the Confirm Assignment dialog is open on-screen).

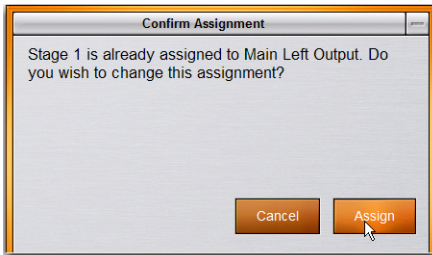

**Warning when reassigning an output that is already in use**

 To suppress the reassignment warning dialog, hold Default on the console or Alt on the computer keyboard while clicking in the patch grid to change the assignment.

## Shortcut for Locating Assignments

Before reassigning in the Patchbay, you may want to double-check the existing assignment to the desired hardware output:

**To identify the bus or channels currently assigned to a hardware output:**

- Click on any dimmed (already assigned) column number at the top of the Patchbay. The Outputs tab containing the assignment is automatically revealed.

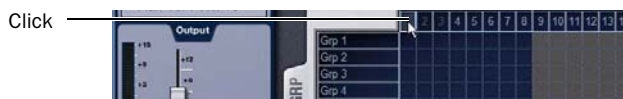

**Clicking a column number to “go to” its current assignment**

## VENUE System Information Export

The System Information Export feature lets you generate an HTML (text) document that details the system’s hardware, software and currently loaded Show file configurations. This document can be read by any Internet browser, such as Internet Explorer, Mozilla Firefox or Safari.

 The patch list can also be exported separately (for more information, see “Patch List Export” on page 114).

The System Information document can be sent directly to production or rental companies to describe your exact console needs. Once exported, the information can be re-formatted as desired by copying and pasting the data into a word processing or spreadsheet application.

**To export VENUE System Information:**

- 1 Insert a USB key disk into a USB port on the system.
- 2 Go to the Options > System page.
- 3 Click the Info button.



**Export VENUE System Information button in Options > System**

4 Do any of the following:

- If you have more than one USB key disk connected, make sure the correct USB key disk is selected. If it is not, click Next Disk to cycle through each available disk until the correct one is selected.
- Click Save to proceed and export system info to the selected USB disk.
- Click Cancel to dismiss the dialog without exporting.

5 Click OK to confirm the export procedure.

You can now remove the USB key disk—from there, you can transfer the exported file to a personal computer for printing, formatting, archiving or distribution.

## Standalone Software

When exporting System Info from the Standalone software, the exported System Information file is displayed immediately using the default browser installed on your computer.

## VENUE System Information Contents

Exported VENUE System Information is saved as an HTML file, and the file name includes the date and time of the export. Contents include the following (not all data will be generated from the Standalone software):



## VENUE

**System Information** Lists the date and time the Info file was generated.

**Console** Lists the current hardware configuration and installed options for the console, including ECx and FWx cards (if any).

**Stage Configuration** Lists card slot contents for each detected Stage Rack or Stage I/O slot.

**Installed Plug-Ins** Lists version and other information (as reported by each plug-in) for all currently installed plug-ins. The list groups plug-ins by whether they are Enabled or Disabled. Enabled and In Use plug-ins appear at the top, followed by any remaining enabled (but not In Use) plug-ins. Plug-in information is not available when exporting from the Standalone software.

**Show File Information** Lists the name, file path, date and time of the most recently loaded Show file.

**System Configuration** Lists information found on the Options > System tab.

**DSP Usage** Lists the processes assigned to each DSP of each Mix Engine card. Information is sub-divided by Mix Engine as displayed on the Options > Devices tab.

**Patch List** Lists the contents of each Patchbay page. A complete patch list is included in the System Information Export, or a detailed patch list can be exported separately from the Patchbay (see next).

---

## Patch List Export

The Patchbay export generates a patch list in an easily readable format.

### To export Patchbay information:

- 1 Insert a USB key disk into any USB port on the console.
- 2 Go to the Patchbay page.
- 3 Click the Export button on the Patchbay page.



Export Patchbay Information icon

### 4 Do any of the following:

- If you have more than one USB key disk connected, make sure the correct USB one is selected. If it is not, click Next Disk to cycle through each available disk until the correct one is selected.
- Click Save to proceed and export Patchbay info to the selected USB key disk.
- Click Cancel to dismiss the dialog without exporting.

### 5 Click OK to confirm the export procedure. You can now remove the USB key disk and transfer the export file to a personal computer for printing, formatting, and distribution.

 *When exporting a Patch List from the Standalone software, the generated HTML file is automatically opened using your default Internet browser (such as Internet Explorer, Mozilla Firefox or other).*

## Contents of Exported Patchbay Information

Exported Patchbay information is saved as an HTML file, and the file name includes the date and time of the export. Contents include the following:

### VENUE Patch List

**Show** Name, file path, date and time of most recently loaded Show file.

### Input and Output Patching

The patch list is divided into three sections: Stage, FOH, and Pro Tools (FWx).

- Stage inputs show global number 1-48, input name(s), card slot and number.
- Stage outputs show global number 1-16 (or 32 on expanded systems), output name, card slot and number.
- FOH (local) inputs and outputs show the physical input/output name and number, where applicable.
- Pro Tools inputs and outputs show all 18 possible input/output assignments.
- Unavailable channels are labelled N/A.
- Direct outs are identified uniquely.

# Chapter 13: Metering

VENUE provides signal metering on the channels, in the metering section, and on-screen.

## Channel Meters

Input and FX return channels provide a compressor/limiter gain reduction meter, an input level meter, and indicator LEDs for EQ, stereo, and gate status.

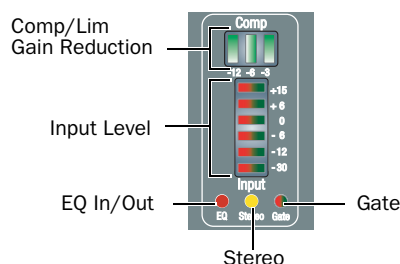

Input channel meters and LEDs

All console channel meters have higher resolution on-screen equivalents that appear in both the targeted channel controls and above the faders in the channel overview.

Meter ballistics and clip margin can be set for channel meters. For more information, see “Metering Options” on page 118.

## Input Channels and FX Returns

### Input Level Meters

Each input and FX return channel strip has a 6-segment Input Level meter that shows input levels from bottom to top, according to the following scale:

LED	Level	Colors
1 (top)	Clip +15 dB	Red Yellow
2	+6 dB	Yellow
3	0 dB	Green
4	-6 dB	Green
5	-12 dB	Green
6 (bottom)	-30 dB	Green

### Compressor/Limiter Gain Reduction Meter

The LEDs in the Compressor/Limiter meter show the amount of gain reduction being applied to the input channel by the built-in Compressor/limiter from right to left, according to the following scale:

Channel Compressor/Limiter gain reduction meter scale

LED	Gain Reduction	Color
none	0 dB	Off
1 (right)	$\leq 3$ dB	Green
2	$\leq 6$ dB	Green
3 (left)	$\leq 12$ dB	Green

### EQ Status LED

A single red LED indicates EQ In/Out status as shown in the following table.

Color	EQ Status
(none)	Not in circuit
Red	In circuit

### Stereo Channel LED

A single yellow LED indicates a stereo input channel. The stereo channel LED flashes if a 12 dB or greater offset is detected between left and right inputs.

Color	Channel Status
(none)	Mono
Yellow	Stereo

### Gate Status LED

A single bi-color LED shows the current Expander or Gate status, as shown in the following table.

Color	Expander Status	Gate Status
(none)	Not in circuit	Not in circuit
Green	3 dB gain reduction	Gate Open & Hold
Yellow	21 dB gain reduction	Gate Release
Red	> 21 dB gain reduction	Gate Closed

## Bank Clip Indicators

The Clip LED at the top of Input Channel and FX Return channels lights when clipping occurs on a hidden fader bank. The channel position of the Clip indication corresponds to the position of the off-bank channel. The Clip LED flashes to indicate momentary clips, and lights solid for sustained clipping.

### To locate the clipped channel:

- Press the Bank switches until the Channel Input Level meters show clipping.

For more information on clip indication, see “Metering Options” on page 118.

## ACS Input and Dynamics Meters

### Selected Channel Level Meters

The Selected Channel meters in the ACS include two 10-segment level meters:

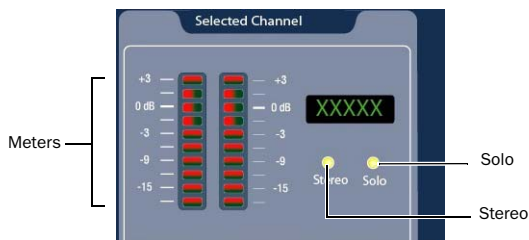

Selected Channel meters and LEDs

These meters show mono or stereo levels on the selected channel. The dual, 10-segment, bi-color LED meters indicate input level for the currently targeted or Solo'ed channel.

### Selected Channel Meter Scale

LED	Level	Color
1 (top)	Clip +15 dB	Red Yellow
2	+9 dB	Yellow
3	+3 dB	Yellow
4	0 dB	Green
5	-3 dB	Green
6	-9 dB	Green
7	-15 dB	Green
8	-21 dB	Green
9	-30 dB	Green
10 (bottom)	-60 dB	Green

## Selected Channel Gain Reduction Meters

The three dynamics gain reduction meters in the ACS section show gain reduction for the built-in Compressor/Limiter (Comp/Lim), the built-in Expander/Gate (Exp/Gate), and any applicable Dynamics plug-in on the selected channel.

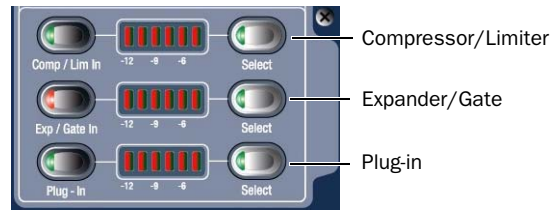

Selected Channel Gain Reduction meters

### Comp/Lim and Plug-In Gain Reduction Meters

On the ACS Comp/Lim and Plug-In gain reduction meters, the 6 LEDs show dynamics gain reduction from right to left, according to the following scales

#### ACS gain reduction meter scale for comp/lim/plug-in

LED	Gain Reduction	Color
(none)	0 dB	(none)
1 (right)	1.5 dB	Green
2	3 dB	Green
3	6 dB	Green
4	9 dB	Green
5	15 dB	Yellow
6 (left)	21 dB	Yellow

### Expander/Gate Gain Reduction Meter

On the ACS Exp/Gate gain reduction meter, the 6 LEDs show dynamics gain reduction from right to left, according to the following scales

#### ACS gain reduction meter scale for exp/gate/plug-in

LED	Gain Reduction	Color
(none)	0 dB	(none)
1 (right)	3 dB	Green
2	6 dB	Green
3	12 dB	Green
4	21 dB	Green
5	36 dB	Yellow
6 (left)	60 dB	Yellow

## Metering Section

The Metering section includes Bus and Main Outputs meters.

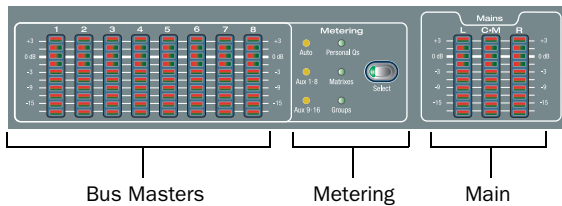

### Meters

All of the 10-segment meters in the meter bridge show levels according to the following scale:

**Table 14. Meter bridge 10-segment meter scale**

LED	Level
1 (top)	+15 dB (red=clip)
2	+9 dB
3	+3 dB
4	0 dB
5	-3 dB
6	-9 dB
7	-15 dB
8	-21 dB
9	-30 dB
10 (bottom)	-60 dB

### Bus Output Meters

The eight output level meters in the meter bridge are assignable as a unit for metering of Groups, Auxes, Matrixes, and Personal Qs.

The Bus Output meters can automatically follow the current Output fader bank assignment (indicating level for the currently selected Output bus), or be assigned to a bus output for persistent bus level indication.

### Stereo Output Metering

With stereo Groups the output level meters in the metering section show level for only the highest of the left and right channels.

To see level for both the left and right channels of a stereo output, refer to the on-screen meters, or target the channel on the ACS and use the Selected Channel Level Meters.

## Selecting Output Meter Display

**To select an output type for metering:**

- Press the Select switch in the metering section to cycle through available choices (Auto, Aux 1–8, Aux 9–16, Personal Qs, Matrixes or Groups). The currently assigned bus is indicated by its Meter LED lighting.

**To set metering to follow the Output faders:**

- Press the Meter Select switch repeatedly so that the Auto LED is lit.

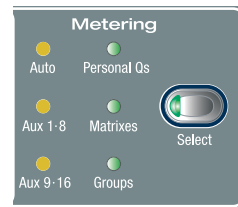

**Bus output LEDs and Select switch**

## Main Output Meters

The three Main output meters in the meter bridge show output levels for the three Main outputs (either in L–C–R or in L–R+M format).

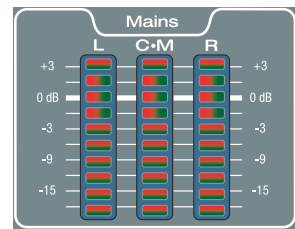

**Main output level meters in the meter bridge**

The 10 LEDs show input levels from bottom to top, according to the scale shown in Table 14 on page 117.

## Metering the Solo Bus

### Metering Soloed Channels

Solo bus metering depends on the type of channel being soloed.

#### Single Channels

In PFL, AFL, or SIP (solo-in-place) modes, a single soloed channel is metered in the same way as if the channel were targeted on the ACS.

## Multiple Channels

In PFL or AFL mode, when multiple channels are soloed, the left and right channels of the Solo bus are metered on the Selected Channel meters, pre-Solo Trim control.

In SIP mode, when multiple channels are soloed, the Left and Right Main bus meters are mirrored on the Selected Channel meters.

## Dynamics Key Listen

When Key Listen is activated, the left and right channels of the Solo bus are metered on the Selected Channel meters, pre-Solo Trim control.

## Solo Clip Indication

When the Selected Channel meters are showing levels of a single soloed channel, the clipping information in the metering section LEDs mirrors that on the channel itself.

When the Selected Channel meters in the metering section are showing Solo bus levels, the meter LEDs turn red to indicate clipping on the Solo bus.

---

## Metering Options

### Meter Display

The following display options can be configured for meters. These options affect all meters on the console.



Metering options in the Interactions tab of the Options page

### Meter Ballistics

Meters can be set to operate in the following modes:

**RMS Mode** (Default) Meters follow the characteristics of a damped analog meter. In this mode, meter response and decay is slower than in Peak mode, providing an average reading of the metered signal. A single LED shows the peak level for the designated Peak Hold Time.

**Peak Mode** Meters follow the characteristics of a standard peak meter. In this mode, meter response is instantaneous, showing the true peak level of the metered signal.

## Peak Hold Time

Peak Hold Time can be set within a range of 0–20 seconds.

### To set the Peak Hold Time:

- 1 Go to the Options page and click the Interactions tab.
- 2 Under Meter, enter a value for the Peak Hold Time.
- 3 Press Enter on the keyboard.

## Clipping Indication

VENUE meter clip indicators are proximity warnings that show when an input or output signal reaches or exceeds the configured Clip Margin.

Clipping can occur at several points throughout the signal chain. A clip at any one of these points is indicated by lighting the top LED red on the meter. For more information on the location of clip detect points, refer to Chapter 26, “Signal Flow Diagrams.”

## Clip Margin

The Clip Margin setting lets you configure the amount of headroom you want before clipping indication begins. Clip Margin is expressed as *dB below maximum* (where maximum is a peak level of +20 dBVU).

Clip Margin can be set within a range of 0 dB to 30 dB below maximum, and is configured separately for inputs and outputs.

### To set the Clip Margin:

- 1 Go to the Options page and click the Interaction tab.
- 2 Under Meter, enter values for Input Clip Margin Below Max and Output Clip Margin Below Max.
- 3 Press Enter to confirm the setting.

## Clip Hold Time

The Clip Hold Time determines how long a clip indication lasts after the last clipped signal. Clip Hold Time can be set within a range of 0–20 seconds.

### To set the Clip Hold Time:

- 1 Go to the Options page and click the Interaction tab.
- 2 Under Meter, enter a value for the Clip Hold Time.
- 3 Press Enter to confirm the setting.

# Chapter 14: Solo and Monitor Busses

## Solo Bus Modes

Three Solo modes are offered: Pre-Fader Listen (PFL), After-Fader Listen (AFL) and Solo In Place (SIP).

- In AFL or PFL mode, soloing only affects what you hear on the dedicated stereo AFL/PFL Solo (Cue) bus, which feeds the Monitor Bus.
- In Solo In Place mode, soloing only affects what you hear in the Main busses.

### Pre-Fader Listen (PFL)

PFL Solo mode sends the signal from explicitly soloed input channels and FX returns to the AFL/PFL Solo (Cue) bus. The signal is post-insert, pre-fader and pre-mute.

Mono input signals are sent to both sides of the Solo (Cue) bus, and the left and right sides of stereo input signals are sent to the corresponding sides of the Solo (Cue) bus.

PFL is the default Solo mode.

### After-Fader Listen (AFL)

AFL Solo mode sends the signal from explicitly soloed channels and solo-safe inputs to the AFL/PFL Solo (Cue) bus. Soloing of output busses is always AFL.

In AFL Solo mode, both input and output signals are sent to the Solo (Cue) bus post-fader and post-pan/balance, and are always panned to stereo even if the Main busses are configured in L-C-R mode.

### Monitoring Aux and Variable Group Busses with AFL

Linked Aux busses and Variable Group busses use true stereo AFL. When you solo a linked Aux bus, the two busses are heard as a stereo pair on the Solo (Cue) bus.

Mono Aux busses and Variable Group are heard as dual mono on the Solo (Cue) bus.

### Solo In Place (SIP)

SIP mode applies to input channels and FX returns only. Solo In Place sends the signal from the soloed channel to the Mains and Monitor busses. Signal is sent post-pan/balance.

**⚠** In SIP Solo mode, audio is sent directly to the Main busses. Use this feature with caution.

## Selecting a Solo Mode

The Solo mode can be selected from the Solo/PFL section or on-screen.

**To select the Solo mode from the console, do one of the following:**

- Press the Stereo AFL switch to enter AFL Solo mode.
- Press and hold the Solo In Place switch for at least 2 seconds to enter SIP mode.
- Press a lit Solo mode switch to turn it off. When no switch is lit in the Solo/PFL section, the system is in PFL mode.

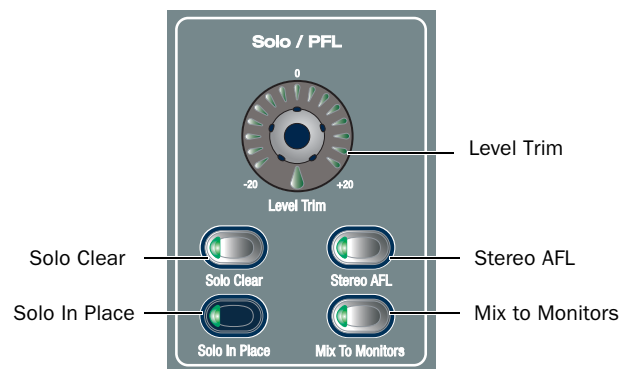

Solo bus controls

**To select the Solo mode on-screen:**

- 1 Go to the Options page and click the Busses tab.
- 2 Under Solo and Monitor Operations, click the Type pop-up and choose the desired Solo mode.



Choosing the Solo mode in Options > Busses



## Solo States and Modes when Loading Shows

**Channel Solo States** When you load a Show file, all solos are cleared. Solo states are not saved with Show files.

**Solo Mode** Show files do not open in SIP mode. If you save a Show file while in SIP, when you reopen the Show file, it will open in AFL Solo mode.

---

## Solo Operation Options

### Momentary or Latching Switch Operation

Channel solo switches can operate with momentary or latching behavior.

#### To engage momentary solo on a channel:

- Hold the solo switch for more than one second. Release the solo switch to unsolo the channel.

#### To latch solo on a channel:

- Press and release the solo switch. Press the switch a second time to unsolo the channel.

### Auxes/Variable Groups Follow AFL and AFL Follows Auxes/Variable Groups

You can customize how encoder banking and AFL interact.

#### Auxes/Variable Groups Follow AFL

When the Auxes/Variable Groups Follow AFL option is selected, soloing an Aux/Var Group bus by pressing its AFL switch assigns level and pan controls for that bus to the input encoders.

- With mono busses, level is assigned to the input encoders. With stereo (linked) busses, level is assigned to the encoders.
- When Flip to Faders is pressed, level is flipped to the faders and pan for the Aux/Var Group bus (even numbered send) is automatically mapped to the input encoders. The pan button flashes while this mode is enabled.

 *If the encoders were already flipped to the faders, flipped status is maintained when an Aux bus is soloed.*

#### To set Auxes and Variable Groups to follow solo:

- 1 Go to the Options page and click the Busses tab.
- 2 Under Solo and Monitor Operation, select the Auxes/Variable Groups Follow AFL option.



*Solo and Monitor Operation settings in the Options > Busses page.*

- 3 Solo an Aux output bus by pressing its AFL switch.

#### To cancel display of Aux send controls:

- Unsolo the bus, or select any other parameter for the input encoders.

#### AFL Follows Auxes/Variable Groups

When the AFL Follows Auxes/Variable Groups option is selected, assigning encoders to an Aux/Var Group automatically solos that bus. The AFL Follows Auxes setting is stored and recalled with each Show file. By default, the option is off (not selected).

#### To set AFL to follow Aux encoder assignment:

- 1 Go to the Options > Busses tab and select the AFL Follows Auxes/Variable Groups option.
- 2 In the Input section, assign encoders to an Aux Send bus.

#### To cancel (unsolo) in AFL Follows Auxes mode:

- Press the flashing Solo Clear button

 *The Events List can be used to assign the Solo Clear function to a footswitch or any other available trigger.*

### Auto Cancel and Input Priority

The Auto Cancel option determines whether Solo switches cancel other soloed channels or are additive (latching). Input Priority determines whether or not soloed inputs replace soloed outputs on the AFL/PFL Solo bus.

#### To set Solo switch operation:

- 1 Go to the Options page and click the Busses tab.
- 2 Under Solo and Monitor Operations, select the options in any of the following combinations:

**Auto Cancel On, Input Priority Off** A solo cancels all other solos (inputs and outputs)

**Auto Cancel On, Input Priority On** An input solo cancels all other soloed inputs; an output solo cancels all other output solos; soloed inputs temporarily replace soloed outputs

**Auto Cancel Off, Input Priority Off** Solos are additive, and soloed inputs and outputs are heard together

**Auto Cancel Off, Input Priority On** Solos are additive, and soloed inputs temporarily replace soloed outputs.



---

## Solo Bus Operation

### Soloing Channels

Solo operation depends on the type of channel being soloed, and on any selected Solo switch options. In all modes, a channel Solo switch lights to indicate that the channel is soloed.

#### Input Channels

Pressing a Solo switch on an input channel or FX Return sends signal to the Solo (Cue) bus (when in PFL or AFL modes) or to the Mains bus (when in SIP mode).

In SIP mode only, when a channel is soloed, all other channels that are not soloed or solo safe are implicitly muted. Implicit mutes are indicated by a flashing mute switch.

#### Output Busses

When the AFL switch in the Output section is pressed, signal is sent to the AFL/PFL Solo bus. This applies to Groups, Auxes, Matrixes, and Personal Qs. Outputs are always AFL.

### Soloing Single Channels

**To solo a single channel, do one of the following:**

- Press the channel's Solo switch so it is lit. The solo switch latches on a momentary press.
  - or –
- Hold the channel Solo switch for more than one second for momentary solo. The channel will automatically unsolo when you release the switch.

### Soloing Multiple Channels

**To solo multiple channels, do one of the following:**

- With the Auto Cancel option enabled, press the Solo switches on multiple channels simultaneously.
- Hold Multi-Select (Shift) and press the Solo switches on one or more channels.
  - or –
- With Auto Cancel disabled, press the Solo switches on multiple channels in any sequence. The Solo switches latch on.

### Toggling the Solo Status of Multiple Channels

**To toggle Solo on multiple channels, do one of the following:**

- With Auto Cancel enabled, hold the Multi-Select switch while pressing the Solo switches on channels to toggle.
  - or –
- With Auto Cancel disabled, press Solo switches in any sequence. The Solo switches latch on and off.

### Soloing VCAs

When you solo a VCA, its member channels are soloed. If the VCA members include a combination of input and output channels, their solo status follows any Solo switch options. See “Solo Operation Options” on page 120.

**To solo the members of a VCA:**

- Press the Solo switch on the VCA channels whose members you want to solo so that the Solo switch is lit.

### Clearing Solos

Press the flashing Solo Clear switch in the Monitoring section to clear all soloed channels.

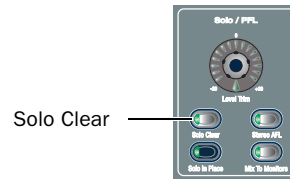

Solo Clear

### Solo Bus Metering

When a channel or dynamics key input is sent to the Solo bus, its signal is metered on the Selected Channel meters, temporarily replacing any currently targeted channel. For more information, see “Metering the Solo Bus” on page 117.

---

## Solo Safing Channels

Solo Safe is a state which prevents a channel from being implicitly muted when any other channel is soloed. Only input and FX return channels can be made solo safe. Solo safed channels are automatically added to any explicitly soloed channels. Solo Safe only applies to SIP and AFL modes. Solo safe status is ignored in PFL mode.

To toggle the solo safe status of Input Channels and FX Returns, the input switches must be set to Solo Safe mode.

**To set Safe switches to control the Solo Safe function:**

- 1 Go to the Options page and click the Interaction tab.
- 2 Under Input Safe Switches, select Act as Solo Safes.

**To toggle the solo safe status of a channel, do the following:**

- Select one or more channels, then press the Safe switch in the Selected Channel Input section.
  - or –
- Click the on-screen Solo Safe button for the channel.



On-screen Solo Safe button

The Safe switch and button flash to indicate the channel is solo safe. When a channel is soloed because of its Solo Safe status, its Solo switch flashes.

## Monitor Bus Operation

The Monitor bus outputs signal to both the near-field monitor output (FOH Rack) and headphone output on the console. The Monitor bus outputs can also be routed to hardware outputs and to bus-fed plug-ins.

## Monitor Bus Switching

The following signals can feed the Monitor bus, listed below in order of priority: Key Listen, Solo (Cue) bus, 2-Track return, COM input, and the Mains mix.

### Dynamics Key Listen

Pressing a Key Listen button on-screen sends the key signal from the targeted channel's built-in dynamics processor to the Monitor bus.

Key Listen temporarily overrides the currently enabled Solo bus operation (PFL or AFL), and replaces any other signal on the Monitor bus with the mono key signal.

### AFL/PFL Solo Bus

In AFL or PFL mode, signal from any soloed channels is sent to the Monitor bus. When any channel is soloed, the Solo bus overrides the 2-Track return if it is enabled, or the Mains mix if it is currently being sent to the monitors.

### 2-Track Return

If 2-Track input is enabled, any signal from those inputs is sent to the Monitor bus. If Mix to Monitors is enabled, the 2-Track input overrides it so you can monitor the 2-Track return without having to disable Mix to Monitors.

### Mix to Monitors

The Mains mix (the signal present on the Mains busses) can be sent to the Monitor bus.

## Assignable Monitor Output

The Monitor bus can be routed to hardware outputs and to bus-fed plug-ins.

**⚠** *These feeds are in addition to the existing, dedicated Monitor outputs on the Mix Rack and FOH Rack, and are taken post-Monitor Speakers control and post-Monitor bus delay.*

**Hardware Outputs** For routing to hardware outputs, the Monitor (Solo) bus outputs are available in the Mains tab of the Patchbay Outputs page. Monitor bus outputs are assignable to any number of physical outputs on the system. Use this capability to route monitor outputs to multiple cue stations (in-ear mix and wedge mix), or to an outboard analyzer.

**Bus-Fed Plug-Ins** For routing to bus-fed plug-ins, the Monitor bus appears as a choice in the plug-in routing selector. This lets you route the Monitor bus to a bus-fed stereo plug-in such as an onboard analyzer. Plug-ins can not be inserted on the Monitor bus.

## Routing the Monitor Bus to Additional Outputs

**To route the Monitor bus to additional outputs:**

- 1 In the Patchbay, go to Outputs and click the Mains tab.
- 2 Click in the grid to assign the Monitor output to the desired destination.

**💡** *Solo In Place, when engaged, is simultaneously routed to the Mains and Monitor busses.*

## Routing the Monitor Bus to Plug-Ins

**To route Monitor output to a bus-fed plug-in:**

- 1 Go to the Plug-Ins page.
- 2 Make sure the desired stereo plug-in is installed and assigned to a rack slot.
- 3 Click the Plug-In Input selector at the top of the corresponding rack slot, and choose Bus Outs > Mains > Monitor - stereo.

**💡** *Plug-in outputs cannot be returned to input channels, in order to prevent feedback loops.*



Assigning monitor output to a bus-fed plug-in

## Sending the Main Mix to the Monitor Bus

### Monitor Output from an L-C-R Main Mix

The stereo Mix to Monitors signal is derived from the L-C-R Main mix by adding a -3 dB signal from the Center channel to the Left and Right monitor channels.

### Monitor Output from an L-R+M Main Mix

In a L-R+M Main mix, only the Left and Right channels are heard in the Solo bus.

#### To send the Main mix to the monitors:

- 1 Do one of the following:
  - Press the Mix to Monitors switch in the Mains section.
  - or –
  - Go to the Options > Busses tab and select the Mix to Monitors option.
- 2 Turn the Monitor Speakers knob or the Headphones knob to adjust the corresponding output level.

## Adjusting Solo Bus Level

PFL Solo bus levels can be controlled by the Level Trim knob in the Solo/PFL section, and with the on-screen Level Trim control. The trim amount is adjustable over a range of -20 dB to +20 dB.

Because Level Trim only affects PFL signals, you can easily balance AFL signals or Mix to Monitors with PFL signals, with a minimum of Monitoring level adjustment during a show.

#### To trim the Solo bus level:

- 1 Solo a channel or press a Key Listen switch.
- 2 Do one of the following:
  - Turn the Level Trim knob to control the amount of signal sent to the Monitor bus.
  - Go to the Options > Busses tab and adjust the Level Trim setting in the Solo and Monitor Operations section.

The following diagrams show the signal flow for PFL and AFL modes.

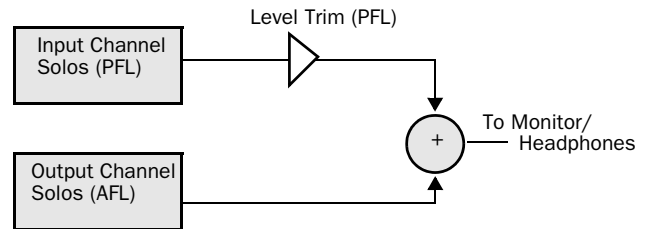

Level Trim in PFL mode

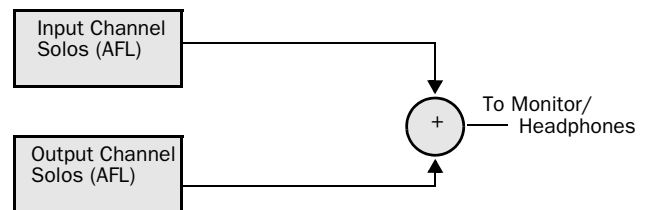

No Level Trim in AFL mode

## Adjusting Monitoring and Headphone Level

Output levels for the near-field monitors and headphones are controlled by the corresponding volume knobs in the Monitoring section. You can also use the on-screen controls, or map Cue to the Mains fader.

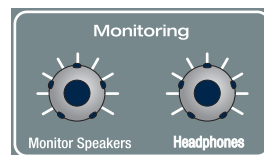

Monitoring controls

## Adjusting Monitor Level and Delay

#### To adjust Solo/Monitor level from the console Monitoring section:

- Adjust the Monitoring or Headphone level, as needed.

💡 See also "Cue on Mains Fader" on page 124.

#### To adjust the Solo/Monitor level on-screen:

- 1 Go to the Options > Busses tab.
- 2 In the Solo and Monitor Operations section, adjust the Monitoring encoder.

You can apply an adjustable delay to the monitor outputs and headphone outputs to match the acoustic delay from the main speaker system.

**To adjust monitor output delay:**

- 1 Go to the Options > Busses tab.
- 2 Adjust the Delay setting in the Solo and Monitor Operations section. Be sure to click the In button beneath the on-screen encoder to enable Delay. When lit, the Delay setting is applied to the monitor output.

**Cue on Mains Fader**

The Mains fader can be assigned to control cue (Monitor bus) output level. Enabling the Cue on Mains Fader option lets you adjust solo PFL/AFL level without having to take your hands off the faders.

Control of the Mains busses remains available from the Output encoders and on-screen in the Outputs page.

The Cue on Mains Fader setting is stored with the Show file.

**To enable Cue on Mains:**

- 1 Turn the Monitoring encoder fully counter-clockwise (off).
- 2 Go to the Options > Busses page.
- 3 Under Solo and Monitor Operations, select the Cue on Mains Fader option.



**Cue on Mains**

The Mains fader now controls Monitoring level. The Mains Select switch flashes quickly.

**To exit Cue on Mains (return to normal):**

- Go to the Options > Busses page, then click to deselect the Cue on Mains option.

*💡 You can set up an Event to toggle Cue on Mains on or off. See Chapter 22, "Events."*

While Cue on Mains is enabled, the Mains busses remain available on-screen, and can be targeted to the ACS.

**Adjusting the Mains While Cue On Mains Fader is Enabled**

When Cue on Mains Fader is enabled, the Mains output level remains at its last setting and remains accessible from the console and on-screen, as follows:

**Adjusting Mains with the Output Encoders**

Enabling Cue on Mains Fader puts Mains control on Output encoders 1—3.

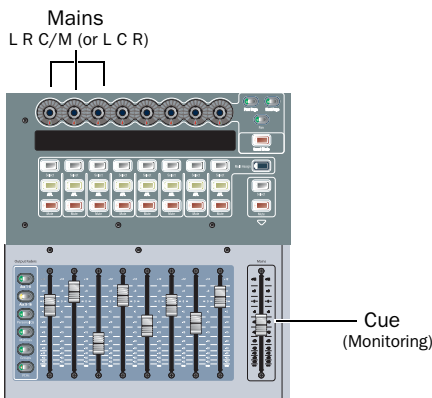

**Bus control while Cue on Mains is enabled**

While Cue on Mains Fader is active:

- Enabling Insert mode replaces the current Output encoder assignments with insert controls.
- Banking to Matrix or PQ replaces the current Output encoder assignments with the sources for the selected Matrix or PQ.

**Adjusting Mains On-Screen**

You can use the controls in the Outputs page on-screen to select, mute, or adjust the level of any of the Mains busses (L, R and C/Mono).

Select a Mains bus on-screen to target it in the ACS, then use the selected channel controls to select, mute, or adjust the level of the Mains busses.

## Talkback, 2-Track and Oscillator Controls

You can assign Talkback microphone input, 2-Track source inputs, and the built-in Oscillator to any Input Channel or FX Return. Talkback, 2-Track, and built-in Oscillator output can be routed to any output busses.

### Using Talkback

The Talkback input on the console accepts signal from any dynamic or condenser microphone.

### Assigning Talkback Microphone Input

**To assign Talkback input to an Input Channel or FX Return:**

- 1 Go to the Patchbay > Inputs tab, then click the Channels tab or the FX Returns tab.
- 2 At the top of the channel grid, click the FOH tab.
- 3 Click in the channel grid to assign the Talk input source to an Input Channel or FX Return (listed on the left).



Assigning Talkback input to an Input Channel in the Patchbay

### Routing Talkback to an Output

**To route Talkback input directly to an output:**

- 1 Press the Talkback switch in the Talkback/Osc section so that it is lit.
- 2 Press the Route to Selected switch. The switch flashes to indicate Route to Selected mode.
- 3 Press the Select switch on each of the output busses (Auxes, Groups, PQs, Matrixes, or Mains) where you want to route Talkback signal. The Select switches flash to indicate Talkback assignment.
- 4 Press the flashing Route to Selected switch to confirm the assignment, or press the Cancel switch to cancel the assignment.

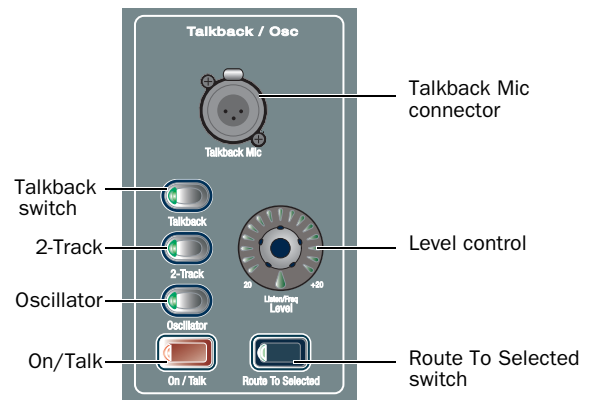

Talkback controls in the Talkback/Osc section

### Activating Talkback Input and Setting Level

**To activate and set the level for Talkback input:**

- 1 Press the Talkback switch in the Talkback/Osc section so that it is lit.
- 2 Activate Talkback by doing one of the following:
  - Press the On/Talk switch in the Talkback/Osc section.
  - Click the on-screen In button in the Talkback section of the Options > Misc page.
- 3 Set the Talkback input level by doing one of the following:
  - Turn the Level knob in the Talkback/Osc section.
  - or –
  - Drag the on-screen Level knob in the Talkback section of the Options > Misc page.

**To route Talkback directly to an output on-screen:**

- 1 Go to the Options > Misc page and click the Route button in the Talkback sections.



Talkback controls in the Options > Misc page

- 2 Go to the Outputs page and click to select the desired output (it flashes briefly).
- 3 In the confirmation dialog that appears, click Route to confirm your assignment or click Cancel to cancel without changing the current routing.

**⚠** Signals are routed to output busses post-mute and post-fader.

**💡** You can designate a footswitch, Function switch or other triggers to control Talkback. For more information, see Chapter 22, “Events.”

## Setting Talkback Dim Level

When Talkback is sent directly to an Output bus, the bus program material (minus the talkback signal) is automatically reduced by the amount specified in the Dim Level setting.

### To set the Talkback Dim Level:

- 1 Go to the Options page and click the Misc tab.
- 2 In the Talkback section, double-click the Dim Level text box and enter a Dim Level value in the range  $-60$  dB (maximum gain reduction) to  $0$  dB (no gain reduction).

## Activating Phantom Power for Talkback Input

The Talkback input has available  $+15$ V phantom power for using a condenser microphone.

### To apply phantom power to the talkback mic input:

- On the back panel, move the Talkback Mic Phantom Power switch to the right.

## Using the Intercom (“Com”)

The Intercom (“Com”) input on the Mix Rack or FOH Rack can accept input from any compatible dynamic or condenser microphone.

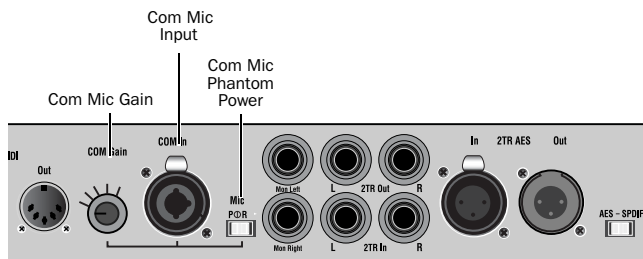

Intercom controls

When activated, the Intercom signal is mixed into the Monitor bus after the source selectors in the Solo/PFL selection, so is audible no matter what source (AFL/PFL, 2-Track, or Main Mix) is sent to the Monitor bus.

The Intercom signal can also be routed to any input or FX return channel.

## Routing Intercom Input

### To route Intercom input to any input channel or FX return:

- 1 Go to the Patchbay and click the Inputs tab.
- 2 To the left of the channel grid, click the Channels tab or the FX Returns tab.
- 3 At the top of the channel grid, click the FOH tab.

- 4 Click in the channel grid to assign the Com input source (at the top right of the grid) to an Input Channel or FX Return (listed on the left).



Routing Intercom input in the Patchbay

## Activating Intercom Input

### To activate the Com input so it is mixed with the Monitor bus:

- 1 Route the Intercom input as described in the previous section (“Routing Intercom Input” on page 126).
- 2 Press the Talkback button in the Talkback/Osc section and press the Level encoder to turn COM on/off (its LED ring lights).

## Activating Phantom Power for Intercom Input

The Com input has available  $15$ V phantom power for using a condenser microphone.

### To apply phantom power to the Intercom microphone:

- On the back panel of the FOH Rack, move the Com Mic Phantom Power switch to the right.

### To set the Intercom microphone input level:

- On the back panel of the FOH Rack, turn the Com Mic Gain knob.

## Using 2-Track Inputs and Outputs

Analog and Digital 2-Track Inputs and Outputs are available.

## Assigning 2-Track Source Input

### To assign the 2-Track inputs to Input Channels or FX Returns:

- 1 Go to the Patchbay > Inputs tab and click the Channels tab or the FX Returns tab.
- 2 At the top of the channel grid, click the FOH tab.
- 3 Click in the channel grid to assign any of the following 2-Track input sources (listed at the top right of the grid) to an Input Channel or FX Return (listed on the left):
  - AL (Analog Left)
  - AR (Analog Right)
  - DL (Digital Left)
  - DR (Digital Right)



## Activating 2-Track Input and Setting Level

### To feed 2-Track input to the Monitor and Mains busses:

- 1 Go to the Options > Misc screen.
- 2 In the 2-Track section, click the Input Fed to Monitors and Masters pop-up and select Analog 2-Track or Digital 2-Track.

### To activate 2-Track input and set level:

- 1 Click the on-screen In button in the 2-Track section of the Options > Misc page.
- 2 Drag the on-screen Level knob in the 2-Track section of the Options > Misc page.



2-Track controls in the Options > Misc page

## Routing 2-Track to an Output Bus

### To route the 2-Track inputs directly to an output bus:

- 1 Go to the Options > Misc tab.
- 2 Click the Route button in the 2-Track section on-screen. The switch flashes to indicate Route to Selected mode.
- 3 Press the Select switch on each of the output channels (Auxes, Groups, Matrixes, or Mains) where you want to route 2-Track signal. The Select switches flash to indicate 2-Track assignment.
- 4 Click Done in the Route to Selected dialog to confirm the assignment.

**⚠** Signals are routed to output busses post-mute and post-fader.

## Routing to the 2-Track Outputs

You can route any output bus or Direct Output to the 2-Track outputs.

### To route any output bus to the 2-Track outputs:

- 1 Go to the Patchbay and click the Outputs tab.
- 2 To the left of the channel grid, click the tab for an Output bus (Auxes, Groups, PQs, Matrixes, or Mains).
- 3 At the top of the channel grid, click the FOH tab.
- 4 Click in the channel grid to assign an Output bus (listed on the left) to any of the following 2-Track output sources (listed at the top right of the grid):
  - AL (Analog Left)
  - AR (Analog Right)
  - DL (Digital Left)
  - DR (Digital Right)

### To route a Direct Output to the 2-Track outputs:

- 1 Go to the Patchbay and click the Directs tab.
- 2 To the left of the channel grid, click the tab for a channel source (Channels, FX Returns, or Outputs).
- 3 At the top of the channel grid, click the FOH tab.
- 4 Click in the channel grid to assign a channel source (listed on the left) to any of the following 2-Track output sources (listed at the top right of the grid):
  - AL (Analog Left)
  - AR (Analog Right)
  - DL (Digital Left)
  - DR (Digital Right)



---

## Routing the Oscillator

The output of the internal oscillator can be routed to Input Channels, FX Returns, or any of the output busses. The Oscillator provides selectable signal type, frequency (for Variable Sine) and signal level, as well as a master on/off switch.

### Configuring the Oscillator and Setting Level

**To activate and set the level for the oscillator:**

- 1 Go to the Options > Misc page.
- 2 As a precaution, click and drag the on-screen Level encoder down to set Oscillator level to off before you proceed.



*Oscillator controls in the Options > Misc page*

- 3 In the Oscillator section, click the Signal pop-up and select from the following signal types:
  - 100 Hz Sine
  - 1 kHz Sine
  - 10 kHz Sine
  - Variable Sine
  - Pink Noise
  - White Noise
- 4 If you select Variable Sine, you can set the sine wave frequency with the on-screen frequency control (directly to the right of the Signal pop-up).
- 5 Click the on-screen In button in the Oscillator section.
- 6 Set oscillator level by slowly raising the on-screen Level encoder.

**To assign the Oscillator signal to an output bus:**

- 1 In the Options > Misc page, click the Route button in the Oscillator section.
- 2 Do either of the following:
  - If you had already selected the desired output, click to confirm the currently displayed Route To mode (in the lower left corner of the screen).
  - or –
  - Go to the Outputs page and click to select an output (it flashes briefly).
- 3 In the confirmation dialog that appears, click Route to confirm your assignment or click Cancel to cancel without changing the current routing.

**⚠** *Signals are routed to output busses post-mute and post fader.*

### Talkback, 2-Track and Oscillator States When Loading Shows

When you load a Show file, Talkback, 2-Track and Oscillator controls are set to off (deactivated), regardless of their state when the Show was last saved.

# Chapter 15: Muting and Mute Groups

## Muting

Channels can be muted in three ways: explicitly (lit solid), with the channel mute switch; implicitly (flashing), as a result of another channel being soloed, and as a member of a Mute Group or VCA (flashing).

Mute switches always behave in additive (latched) fashion. Channels can be muted in any sequence, and they will remain muted until they are unmuted.

The following provide some additional information about channels, busses, and muting:

**Input Channels and FX Returns** Channel mute is pre-fader on input channels and FX returns.

**Output Busses** Mute operation is post-fader on all types of Output busses.

**Mains** The mute status of the Main busses is controlled from the Mute switch above the Mains Fader.

Only the linked Mains busses are muted. The Mains Mute switch flashes to indicate not all Mains are muted. For information on linking Mains, see “Linking Mains” on page 84.

**VCAs** When you mute a VCA, its member channels are muted. The member channel Mute switches flash to indicate they are muted as part of a VCA.

## Flashing Mute Indication

A flashing Mute switch indicates the channel is implicitly muted as a result of a Solo or Mute Group activation.

**Solo** In Solo In Place mode, when a channel or VCA is soloed, all other channels that are not soloed or solo safe are implicitly muted.

**Mute Group** Members of a mute group are implicitly muted and flash when the mute group is active.

## Mute Groups

Channels can be assigned to any of the 8 available Mute Groups. Mute Groups let you mute and unmute multiple channels simultaneously by pressing a single switch.

Any type of channel, including all Input Channels and all Output channels, except VCAs, can be assigned to Mute Groups.

Mute Groups only affect the status of channel Mute switches, and do not affect the on/off status of Aux Sends, output of the Talkback/Oscillator section, or the routing of signals to the monitor outputs.

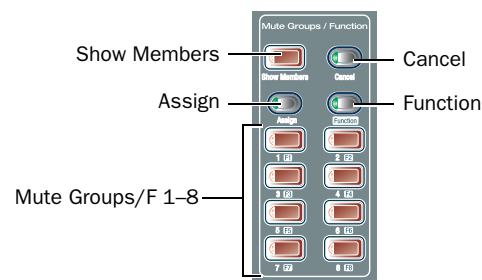

Mute Groups section

## Assigning Mute Groups

Mute Groups can be defined from the console or on-screen. Any mixture of channel types can be assigned to a Mute Group. Channels can be assigned to more than one Mute Group.

### To assign or remove channels from a Mute Group:

- 1 Make sure the Mute Groups/Function section is in Mute Groups mode. If the Function switch is lit, press it so that it turns off (indicating Mute Groups mode).
- 2 Press the Assign switch in the Mute Groups section. The Assign switch flashes to indicate Assign mode.
- 3 Press the Mute Group switch (1–8) for the group where you want to assign or remove a channel. This switch flashes to indicate the group is targeted for assignment.
- 4 Press the Select switch for each channel you want to assign or remove from the Mute Group. The Select switches on the selected channels flash.

5 Do one of the following:

- To confirm the Mute Group definition, press the flashing Assign switch or the flashing Mute Group switch (1–8).
- or –
- To cancel the Mute Group definition, press the Cancel switch in the Function section.

**To assign or remove members of a Mute Group on-screen:**

- 1 Go to the Inputs or Outputs page.
- 2 Click the Assign button in the Mute Groups section (to the right of the on-screen faders). The Assign button flashes to indicate Assign mode.



*Mute Group Assign mode*

- 3 Below the flashing Assign button, one of the Mute Group buttons 1–8 flashes to show which Mute Group is selected for assignment. If desired, click to select a different Mute Group.
- 4 Click to select the channels you want assigned to the selected Mute Group (click their fader strips to select individual channels; click their on-screen bank numbers to select multiple channels at once).
- 5 Do one of the following:
  - To confirm the Mute Group definition, click the flashing Assign button or the flashing Mute Group switch (1–8).
  - Click the on-screen banner display to show the confirmation dialog, then click Assign.
  - or –
  - To cancel the Mute Group definition, click the on-screen banner display and click Cancel.

## Viewing Members of Mute Groups

You can view Mute Group members in input channels and FX returns.

**To view the members of Mute Groups in the Inputs section:**

- Press the Show Members switch in the Mute Groups section.

The Bus Assign LEDs 1–8 at the top of each input channel flash in each channel to indicate membership in the corresponding Mute Group.

Press Cancel to leave Show Members mode and return the Input section to its previous display.

## Using Mute Groups

Mute Groups are activated from the Mute Groups section on the console or from the Mute Group controls on-screen in the Inputs and Outputs pages.

**To activate a Mute Group:**

- 1 Make sure the Mute Groups / Function section is in Mute Groups mode. If the Function switch is lit, press it so that it turns off (indicating Mute Groups mode).
- 2 Press a Mute Groups switch 1–8 to mute the members of the corresponding group. The Mute switches of the Mute Group members flash to indicate they are implicitly muted.

**To activate multiple Mute Groups:**

- Press any number of Mute Group switches 1–8 in any sequence. Mute Groups function in an additive fashion.

**To deactivate a Mute Group:**

- Press a lit Mute Group switch.

## Explicit and Implicit Channel Mute with Mute Groups and VCAs

This section describes the behavior of channel Mute switches when used with Mute Groups and VCAs. Solo/PFL implicit mute behavior is unchanged.

### Mute Groups, VCAs and Explicit Mutes

Channels can be muted in three ways:

**Explicitly** Using the channel Mute switch.

**Implicitly** As a member of a Mute Group or VCA.

– and –

**Implicitly** As a result of another channel being soloed.

## Using Channel Mute Switches

Any input or output channel implicitly muted by a Mute Group or VCA can be explicitly *un*-muted, explicitly muted, and reset to its implicit mute state by repeatedly pressing a channel Mute switch. Explicitly unmuteing or muting a channel in this way does not permanently remove that channel from the Mute Group or VCA.

This feature is useful to temporarily unmute a channel during a line check without having to release the entire Mute Group or VCA.

### To cycle through the available Mute modes:

- 1 Activate a Mute Group, or mute a VCA. The Mute switches on all implicitly muted channels flash.
- 2 Press a flashing Mute switch to explicitly unmute the channel. Its Mute switch is now unlit.
- 3 Press the same (now unlit) Mute switch again to explicitly mute the channel. Its Mute switch is now lit solid.
- 4 Press the same Mute switch again to implicitly mute the channel and return it to being controlled by the active Mute Group or VCA. Its Mute switch resumes flashing.

 *Select multiple channels first to be able to toggle all their states at once. The Mute behavior may vary if some, but not all, of the selected channels are members of a Mute Group or VCA.*

## Disabling Mute Groups

You can temporarily disable all Mute Group functions. When Mute Groups are disabled, all channels implicitly muted as a result of Mute Group activation are unmuted.

Channels can still be explicitly muted when Mute Groups are disabled. Mute Group assignments are preserved and made available again when Mute Groups are re-enabled.

### To disable Mute Groups:

- 1 Go to the Inputs or Outputs pages.
- 2 Click the Disable button on-screen in the Mute Groups section. The Disable switch flashes to indicated disabled state.

### To re-enable Mute Groups:

- Click the flashing Disable button in the Mute Groups section.



Mute Group controls on-screen

## Function Switches

VENUE Profile provides 8 Function switches (F keys).

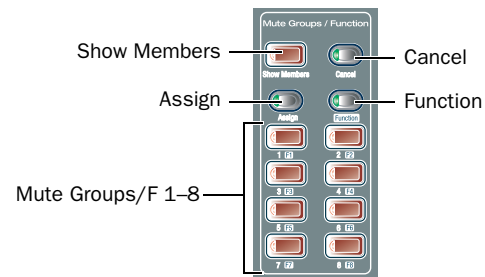

Mute Groups/Function switches (F keys) section

The function and behavior of each Function switch can be customized in the Event List. By default, Function switches 1–4 are mapped to Preview mode, Variable Groups mode, channel copy and channel paste, respectively.

For more information, see Chapter 22, “Events.”

### To access the Function switches:

- 1 Press the Function switch in the Mute Groups section. When in Function mode, the Function switch LED lights.
- 2 To return to Mute Groups mode, press the Function switch again.



## **Part IV: Processing**





# Chapter 16: Dynamics

VENUE Mix Rack and Profile systems offer the following dynamics features:

- A built-in Compressor/Limiter and Expander/Gate is available on each input channel.
- Dynamics plug-ins can be used on input and output channels.
- All channels let you inset hardware dynamics processors.
- All built-in and most plug-in dynamic processors support side-chain keying with key filtering.
- Dynamics settings can be copied, pasted, stored and recalled using Snapshots and Presets.

## Built-In Dynamics

Each input channel provides a built-in Compressor/Limiter (Comp/Lim), and an Expander/Gate (Exp/Gate). Built-in dynamics are not limited by DSP resources, and can be configured as pre- or post the built-in EQ per channel. Built-in Comp/Lim and Exp/Gate Threshold can be adjusted from the input encoders; all other dynamics parameters can be adjusted using the dedicated Dynamics controls in the ACS, or on-screen.

## Plug-Ins

Dynamics plug-ins can be used on input and output channels. When assigned in the plug-in racks, Dynamics plug-ins can be inserted on individual mono or stereo channels or fed by buses. Dynamics plug-ins can be adjusted using the dedicated Dynamics controls in the ACS, from the Output encoders (in Insert Mode), or from the on-screen Plug-Ins page. In addition, plug-in presets can be stored and loaded.



*The Dynamics controls in the ACS provide a unified set of controls for both built-in and plug-in dynamics processing.*

## Hardware Inserts

You can insert a hardware Dynamics processor and control its in/out state and insert position on-screen. (See Chapter 19, “Hardware Inserts.”)

---

## Built-In Compressor/Limiter

One built-in Compressor/Limiter (Comp/Lim) is available on each input channel. The Comp/Lim defaults to compression, or can be switched to a limiter by setting the Ratio to its maximum setting. Mono and stereo processing are supported.

## Comp/Lim Parameters

**Threshold** Increases or decreases the threshold level for the built-in Comp/Lim.

**Ratio** Increases or decreases the ratio for the Comp/Lim. The most extreme clockwise setting (100:1) switches the process into Limiting mode.

**Attack** Increases or decreases attack time for the Comp/Lim.

**Comp Knee** Increases or decreases the knee width for the Comp/Lim. A knee value of 0 provides a hard knee setting; 100 provides a soft knee.

**Release** Increases or decreases release time for the Comp/Lim.

**Make-Up Gain** Increases or decreases the make-up gain applied by the Comp/Lim.

**In/Out** Takes the Comp/Lim in or out of circuit (bypass).

**Side-Chain Keying** Provides side-chain and key listen. Side-Chain features are available on-screen only. For details, see “Side-Chain Keys and Filters” on page 139.

## Comp/Lim Gain Reduction Meters

Three-segment gain reduction meters on each input channel indicates Comp/Lim gain reduction from left to right, as shown in the following table:

*Channel Compr/Lim gain reduction meter scale*

LED	Gain Reduction	Color
none	0 dB	Off
1 (right)	<= 3 dB	Green
2	<= 6 dB	Green
3 (left)	<= 12 dB	Green

Six-segment gain reduction meters are provided in the ACS for higher resolution metering. (See Chapter 13, “Metering.”)

## Comp/Lim Defaults and Ranges

The following table lists the default values and ranges for the built-in Comp/Lim:

*Comp/Lim (defaults to Compressor mode)*

Parameter	Default	Minimum	Maximum
Threshold	0 dB	-40 dB	+20 dB
Attack	10 ms	100 us	200 ms
Release	100 ms	10 ms	4 sec
Ratio	2:1	1.25:1	100:1
Knee	0 (hard)	0	100
Makeup Gain	0 dB	-40 dB	+20 dB

## Built-In Expander/Gate

One built-in Expander/Gate (Exp/Gate) is available on each input channel. The Exp/Gate defaults to gate (Ratio of 100:1, the maximum setting). It can be switched to Expander mode by setting the Range to its minimum setting. Mono and stereo processing are supported.

### Expander/Gate Parameters

**Threshold** Increases or decreases the threshold level for the built-in Exp/Gate.

**Ratio** Increases or decreases the ratio for the Exp/Gate. The most extreme clockwise setting (100:1) puts the process into Gate mode. Lower settings enable Expander mode.

**Attack** Increases or decreases the attack time for the Exp/Gate.

**Gate Hold** Increases or decreases the time the gate holds.

**Release** Increases or decreases the release time for the Exp/Gate.

**Range** Sets the maximum range or depth of attenuation of the gate on that channel.

**In/Out** Takes the Exp/Gate in or out of circuit (bypass).

**Side-Chain Keying** The Exp/Gate supports side-chain and key listen. For details, see “Side-Chain Keys and Filters” on page 139.

## Exp/Gate Gain Reduction Meters

A single bi-color Gate LED on each input channel indicates Exp/Gate activity, as shown in the following table.

Color	Expander Status	Gate Status
(none)	Not in circuit	Not in circuit
Green	3 dB gain reduction	Gate Open & Hold
Yellow	21 dB gain reduction	Gate Release
Red	> 21 dB gain reduction	Gate Closed

Six-segment gain reduction meters are provided in the ACS for metering of the Exp/Gate on the currently selected channel. (See Chapter 13, “Metering.”)

### Exp/Gate Defaults and Ranges

The following table lists the default values for the Exp/Gate:

*Exp/Gate Defaults (defaults to Gate mode)*

Parameter	Default	Minimum	Maximum
Threshold	0 dB	-60 dB	+20 dB
Attack	1 ms	20 us	500 ms
Release	250 ms	10 ms	4 sec
Ratio	100:1 (Gate mode)	1.25:1	100:1
Gate Hold	100 ms	10 ms	4 sec
Gate Range	-20 dB	-80 dB	0 dB

## Adjusting Dynamics

The VENUE Profile console provides Dynamics controls in input channel strips, the ACS, and on-screen.

### Input Fader Strip Dynamics Controls

All Input fader strips provide Threshold level control for built-in Dynamics.

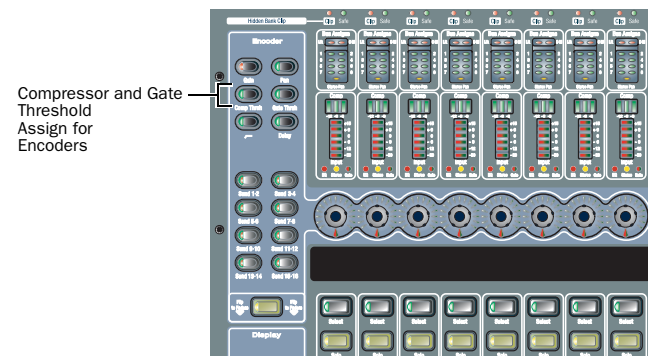

Input Encoder assignment switches for built-in Dynamics

### To adjust Threshold from an input strip:

- 1 Press an Encoder Assign switch (Comp/Lim, or Exp/Gate).
- 2 Rotate a channel encoder to adjust Threshold.

## ACS Dynamics Section

The Dynamics controls in the ACS provide a unified, consistent set of controls for both built-in and plug-in dynamics processing for the targeted channel. Its six dual-purpose rotary/switch encoders, three In/Out switches, three Select switches, and dedicated high-resolution gain reduction meters provide a familiar way to adjust and view any type of Dynamics parameters and their settings.

All -compatible Dynamics plug-ins map their controls to the appropriate ACS encoders and switches.

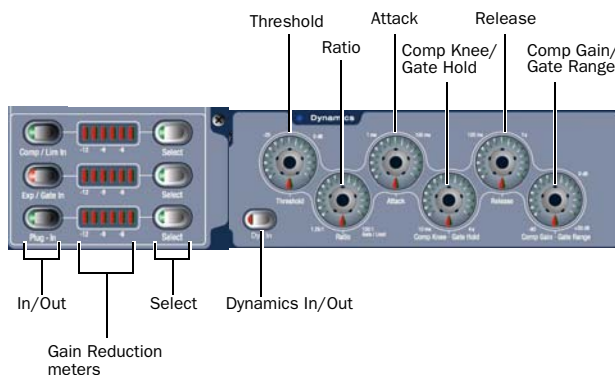

### Dynamics section and controls

#### LED indication of Dynamics Processing

The LEDs beneath each Dynamics encoder light green when the Dynamics section is controlling Comp/Lim or plug-in dynamics parameters, and light red to indicate Exp/Gate mode.

#### To adjust Dynamics parameters from the ACS:

- 1 Target a channel by pressing its Select switch.
- 2 Press the Dynamics Select switch for the corresponding process:
  - For the built-in Compressor/Limiter, press the Comp/Lim Select switch.
  - For the built-in Expander/Gate, press the Exp/Gate Select switch.
  - For a Dynamics plug-in, press the Plug-In Select switch.
- 3 Adjust the appropriate Dynamics parameter.

#### To take the process in/out of circuit:

- Press the appropriate In/Out switch in the ACS Dynamics section (Comp/Lim, Exp/Gate, or Plug-In).
  - or –
- Press the Dyn In switch in the ACS Dynamics section to toggle the currently targeted dynamics processor in or out.

## Software Screen Dynamics Controls

The software screen lets you adjust built-in or plug-in dynamics on-screen, with simultaneous access to Comp/Lim and Exp/Gate parameters (including their side-chain settings).

The Inputs screen also provides the Dynamics Graph display. The Dynamics Graph displays a composite response of the compressor and gate that you can use to view and edit built-in Dynamics parameters.

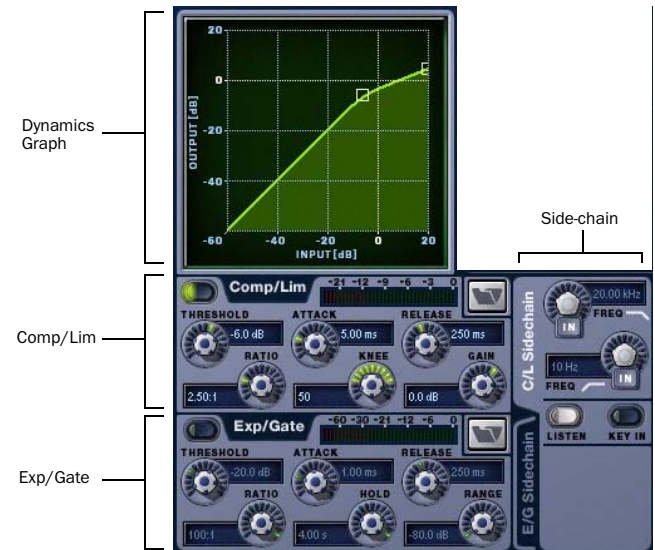

Dynamics controls in the software screen

#### To adjust Dynamics parameters on-screen:

- 1 Select a channel on-screen.
- 2 Adjust the on-screen controls as needed:
  - For the built-in comp/lim or exp/gate, adjust the parameter on-screen.
  - For plug-ins, click the Insert slot displaying the Dynamics plug-in to go to the Plug-Ins page.

#### To reset an on-screen Dynamics parameter to its default value, do one of the following:

- Alt-click the control.
  - or –
- Right-click the control and choose Reset.

#### To reset an entire Dynamics section to its default settings:

- Hold the Default switch and press the Comp/Lim or Exp/Gate Select switches in the ACS Dynamics section.
  - or –
- On-screen, right-click anywhere on the Compressor/Limiter or Expander/Gate sections (but not directly on an encoder or button) and choose Reset.

## Using the Dynamics Graph Display

In addition to the on-screen encoders and buttons, you can adjust Dynamics parameters using the Dynamics Graph.

### To adjust Dynamics on-screen using the Graph display:

1 Select a channel on-screen, and make sure the Comp/Limiter or the Exp/Gate is in circuit, and targeted in the Dynamics Graph.

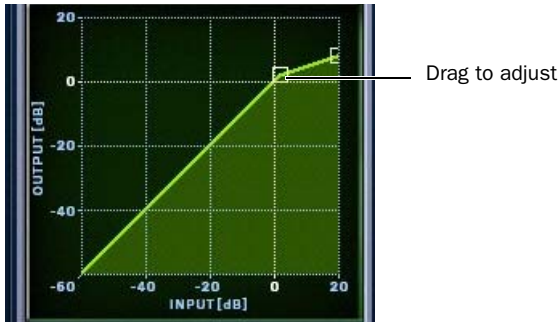

Dragging a handle in the Dynamics graph

 If the channel EQ is currently the target of the Dynamics Graph, click anywhere in the on-screen Comp/Limiter or Exp/Gate sections to change the display.

2 Drag handles in the on-screen Dynamics Graph to adjust Threshold and Ratio.

 The Dynamics Graph does not support Fine adjust mode using the Fine switch.

## Adjusting Dynamics Plug-Ins

Dynamics plug-ins map their threshold, ratio, attack, release, gain, and filter controls to the corresponding in the ACS. (Dynamics controls on input strips can only control built-in dynamics processors.)

 If more than one Dynamics plug-in is inserted on a channel, only the first Exp/Gate will map to the ACS. You can use the Output encoders in Insert mode to control any additional Dynamics plug-ins on the channel.

### To adjust a Dynamics plug-in from the console:

1 Target the channel with the plug-in by pressing the channel Select switch.

2 Press the plug-in Select switch (located next to the ACS gain reduction meters in the Dynamics section), then do one of the following:

- If the plug-in maps correctly, adjust parameters by pressing or turning the corresponding encoders in the ACS Dynamics section.
- If the plug-in does not map to the ACS, press the Insert Mode switch in the Output section. Use the Output encoders to adjust parameters; use the Previous Page and Next page switches to access other parameters.

## Channel Modes Affecting Dynamics

Both the Channel Config settings for Input Direct mode and Dyn Pre EQ affect operation of built-in Dynamics.

### Dyn Pre EQ

By default, built-in Dynamics processing occurs before built-in EQ processing in the signal chain of input channels. This can be changed on a per-channel basis by toggling the channel's Dyn Pre EQ setting.

### To toggle the Dyn Pre EQ setting:

- 1 Target the input channel by pressing its Select switch, and make sure the Inputs page is displayed.
- 2 Click the Dyn Pre EQ button in the (channel) Config section in the upper right corner of the screen. When enabled, the Dyn Pre EQ LED lights.

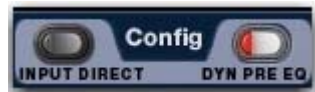

Channel Config controls in the Inputs page

### Input Direct Mode

Input Direct mode lets you completely bypass any and all built-in dynamics and EQ, plug-ins and inserts processing on input channels and FX returns.

### To toggle Input Direct mode:

- 1 Target the input channel by pressing its Select switch, and make sure the Inputs page is displayed.
- 2 Click the Input Direct button in the (channel) Config section in the upper right corner of the screen. When enabled, the Input Direct LED lights.

---

## Dynamics Settings and Presets

Built-in Dynamics settings can be copied and pasted between channels. Settings can also be stored, loaded, and transferred as dynamics Presets.

### Copying and Pasting Dynamics Settings

**To copy and paste dynamics settings:**

- 1 Right-click anywhere in the Comp/Lim or Exp/Gate areas of the on-screen Dynamics section and choose Copy Comp/Lim Settings, or Copy Exp/Gate Settings.



*Copying dynamics settings*

- 2 Go to the channel where you want to paste the settings.
- 3 Right-click in the Comp/Lim or Exp/Gate areas of the desired channel's on-screen Dynamics section and choose Paste Comp/Lim Settings or Paste Exp/Gate Settings.

**To copy and paste all of a channel's built-in Dynamics settings:**

- 1 Right-click in the on-screen Dynamics Graph and choose Copy Dynamics Settings.
- 2 Select the channel where you want to paste the settings.
- 3 Right-click in the on-screen Dynamics Graph of the new channel and choose Paste Dynamics Settings.

### Presets for Built-In Dynamics

You can store and load settings as presets for built-in and plug-in dynamics processors from the console or on-screen.

**To save or load a preset:**

- 1 Adjust dynamics settings on a channel (if saving a preset), or select an input channel (to load a preset).

- 2 Click the Comp/Lim or Exp/Gate Presets icon on-screen.



*Built-in dynamics Presets buttons*

- 3 If necessary, select the appropriate Presets folder by clicking and selecting it from the Folder selector.

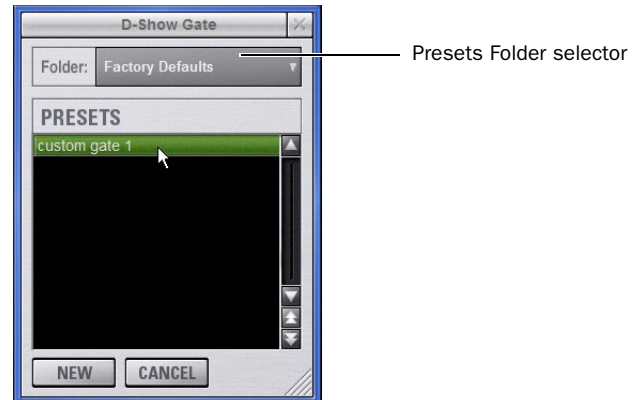

*Previewing a preset in the Presets window*

- 4 Do one of the following:
  - To preview an existing preset, click its name in the Presets window.
  - To load the currently selected preset, press Enter or click the Close box (X) in the Presets window title bar.
  - To save the current dynamics settings as a new preset, click New and enter a name for the preset file.
  - To cancel without changing settings, click Cancel.

---

## Side-Chain Keys and Filters

The built-in Comp/Limiter and Exp/Gate support side-chain triggering.

### Key In/Out

The Key In switch toggles the key signal in or out of circuit for the built-in Comp/Lim or Exp/Gate.

**To toggle the side-chain key signal in or out of circuit, do one of the following:**

- Click the Key In button in the side-chain controls of the on-screen Dynamics section.

When the Comp/Limiter key is in, it uses its own source channel (Self) as the key source signal. When the Exp/Gate key is in, it can be self-keyed or use any other available channel.



## Key Assign

The on-screen Key Assign selectors lets you select the side-chain source for a gate (compressors are always keyed by the channel signal) and its pickoff. The Key Source selector is provided in the Exp/Gate controls.

### Key Sources

The Compressor/Limiter is self-keyed. You can use any of the following as the key source for the Exp/Gate:

- Self
- Any Input (Channel or FX Return)
- Any hardware input

You can also specify the pickoff source for the key signal for input channels.

### To select the key signal for the Gate on-screen:

- 1 Select an Input Channel.
- 2 Click the E/G Side-Chain tab in the Dynamics section to select the gate.
- 3 Click the Key Source selector and choose an available channel or bus.



Choosing a Key Source

### To select a pickoff point for the key source signal:

- Click the Source Pickoff selector and choose a pickoff source for the selected key signal:

## Key Listen

The Key Listen button toggles the key onto the Solo (Cue) bus, replacing any currently soloed channel.

Key Listen always overrides the Solo bus (previously soloed channels are suppressed until Key Listen is cleared). Pressing Solo on other channels while Key Listen adds them but they remain suppressed.

Key Listen is also exclusive to itself; pressing Key Listen on a different processor or channel replaces the previous Key Listen with the new Key Listen.

- ⚠ *Key Listen on a Dynamics plug-in does not route the signal to the Solo bus, but to the plug-in output. Use caution.*

### To engage Key Listen:

- Click the Listen button in the on-screen Exp/Gate controls.

### To disengage Key Listen:

- Click Listen again. The Solo bus reverts to its previous signal. You can press Solo Clear to turn off any engaged Key Listen. Press Solo Clear a second time to clear channel solos, if any.

## Side-Chain Filters

Both the Comp/Limiter and Exp/Gate side-chains provide two bands of EQ to band-limit the key signal.

### To enable a side-chain filter on-screen:

- 1 Click the C/L Side-Chain or E/G Side-Chain tab in the Dynamics section to select the desired processor.
- 2 Click the LPF or HPF side-chain filter In buttons.

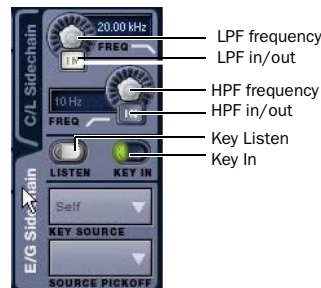

Side-Chain controls in the software screen (Exp/Gate shown)

### To adjust a side-chain EQ:

- Turn the HPF or LPF encoder to adjust the frequency. On-screen, the LEDs around the encoder light, and the current frequency value is displayed on-screen.

### Dynamics side-chain EQ defaults and ranges

Filter	Default	Minimum	Maximum
HPF	10 Hz, Off	10 Hz	20 kHz
LPF	20 kHz, Off	10 Hz	20 kHz

## Side-Chain Limitations

Up to 32 side-chain Key signals can be routed from the following sources:

- Channel pre/post fader pickoff
- FX Return pre/post-fader pickoff
- Channel Insert return

There are no limits to the number of side-chain Key signals that can be routed from hardware inputs, Input Channel or FX Return top-of-channel pickoffs, or channel insert returns.

- ⚠ *Side-chain level may vary dramatically depending on where the Key signal is sourced. The top of channel pickoff can be as much as 18 dB louder than other pickoff points and sources.*







# Chapter 17: EQ

The following EQ features are available:

- A built-in EQ is available on each input channel and FX return.
- Graphic EQs are available for use on output channels.
- EQ plug-ins can be used on input and output channels.
- All channels let you insert hardware EQ processors.
- Dynamics settings can be copied, pasted, stored and recalled using Snapshots and Presets.

## Built-In EQ

Different types of built-in EQ are available for input channels, FX returns, and outputs.

**Input Channels** Each input channel provides a high-pass filter plus a built-in four-band parametric EQ. EQ can be set for digital or analog mode. In digital mode only, the four-band EQ provides selectable Bell/Shelf shapes for the Hi and Lo bands. Input channel EQ can be configured as pre- or post-Dynamics on a per-channel basis.

**FX Returns** Each FX return provides a built-in two-band EQ. FX return EQ can be used in digital or analog mode; in digital mode, the bands can be individually configured for Bell or Shelf modes.

## Graphic EQs

Output busses can have a built-in Graphic EQ assigned to them.

## EQ Plug-Ins

EQ plug-ins can be used on input and output channels. When assigned in the plug-in racks, EQ plug-ins can be inserted on individual mono or stereo channels or fed by busses. EQ plug-ins can be adjusted using the ACS, using the Output encoders (in Insert mode), or from the on-screen Plug-Ins page. Plug-in presets can be saved and loaded.



*The EQ controls in the ACS provide a unified set of controls for both built-in and plug-in EQ processing.*

## Hardware Inserts

You can insert a hardware EQ processor and control its in/out state and insert position on-screen. See Chapter 19, “Hardware Inserts.”)

---

## Built-In EQ Parameters

### HPF

Each input channel provides a fourth-order high-pass filter (HPF) with adjustable corner frequency and in/out control. The input HPF defaults to 20 Hz, out-of-circuit.

You can adjust HPF frequency and in/out state from each input strip, from the ACS, or on-screen.

### Input Parametric EQ

Input channels and FX returns provide built-in parametric EQ. The following parameters are available in the built-in EQ, and can be adjusted using the EQ controls in the ACS or on-screen.

### EQ In

EQ In toggles the built-in EQ processor (all bands) in or out of circuit on the selected channels. EQ In/Out can be controlled from the ACS or on-screen.

### EQ Status LED

The (red) channel EQ In LED indicates EQ in/out status as shown in the following table.

Color	EQ Status
(none)	Not in circuit
Red	In circuit

### Analog and Digital EQ Modes

The Analog/Digital button toggles the built-in parametric EQ between digital mode and analog mode, on a per-channel basis. Analog/digital mode switching is available on-screen.

**Digital Mode** A standard digital parametric EQ. Frequency range of 20 Hz to 20 kHz and gain range of +/-18 dB are available on all four bands. Hi and Lo bands can be Bell (default) or Shelf. Digital Q is expressed in Q factor terms in the range 10 (left, a narrow band) to 0.1 (right, a wide band). Digital Mode is the default EQ mode.

**Analog Mode** An EQ with a response modeled on that of an analog console renowned for its EQ section. Frequency range is limited to match, and the outer bands provide shelving only. Analog Q is expressed in octaves of *bandwidth* in the range 0.1 (left, a tenth of an octave) to 2 (right, two octaves.)

 *The HPF does not change when the EQ is switched between Digital and Analog mode.*

### Gain, Frequency, and Q/Bandwidth

Each band of built-in parametric EQ provides the following parameters, as available on input channels or FX returns:

**Gain** Boosts or cuts the corresponding band. LEDs around the Gain encoder light from the center-point to the right (boost), or from the center-point to the left (cut) to show current Gain.

**Freq** Sets the center or corner frequency, as follows:

- Freq sets the center frequency for the Hi-Mid and Lo-Mid bands, and for the Hi and Lo filters when in Bell mode.
- Freq sets the corner frequency for the Hi and Lo filters when in Shelf mode. (See “Bell and Shelf Modes for Hi and Lo Filters” on page 144.)

Turning the encoder clockwise increases the frequency for that band; turning it counter-clockwise decreases the frequency. A single LED around the encoder shows the current encoder setting. The available range of each band depends on the EQ mode (Digital or Analog). See “Control Ranges for Built-In Parametric EQ (All Modes)” on page 149.

**Q (Q/Bandwidth)** Controls Q (in digital mode) or bandwidth (analog mode).

◆ In Digital mode, Q determines Q factor. When the Hi or Lo filters are in Shelf mode, the Q knob determines the Q of the shelf.

◆ In Analog mode, this control changes to a bandwidth control which performs essentially the same function.

**Band In/Out** Each of the available EQ bands can be taken in or out (bypassed) using their encoder (or on-screen).

◆ In the ACS EQ section, the Gain knob for each band serves as the in/out control by pushing the encoder. The indicator LED lights to indicate band In.

◆ On-screen, a dedicated In/Out switch is located just below each Gain knob.

### Bell and Shelf Modes for Hi and Lo Filters

In digital EQ mode, the Hi and Lo filters on input channels and FX returns can be toggled between Bell and Shelf modes.

When in Bell mode, the Hi or Lo filters function as a parametric EQ with variable Q. When in Shelf mode, the Hi module is a high-shelf EQ, and the Lo module is a low-shelf EQ. For instructions on configuring these bands for Bell or Shelf mode, see “Adjusting EQ” on page 144.

## Adjusting EQ

You can adjust EQ controls in input channel strips, in the ACS, and on-screen.

### Adjusting HPF Controls

Each input strip provides HPF frequency control. HPF can be adjusted using the Encoder HPF switch and row of encoders.

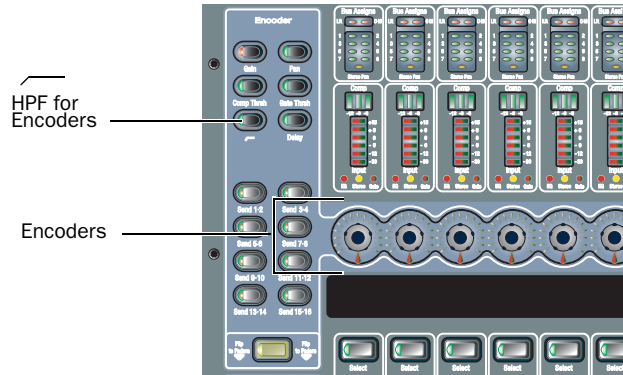

HPF controls for input channels

#### To adjust HPF:

- 1 Bank the Input section to the desired channels.
- 2 Press the HPF Encoder Assign switch.
- 3 Rotate the appropriate channel Encoder to adjust its HPF frequency. Press the appropriate encoder shaft switch to toggle HPF in or out.

### Adjusting Channel Parametric EQ Controls

The EQ controls in the ACS provide a unified, consistent set of controls for both built-in and plug-in EQ processing for the targeted channel. Twelve dual-purpose rotary/switch encoders control EQ parameters and their settings.

EQ plug-ins can map their controls to the ACS EQ section, and all plug-ins can be controlled using the Output encoders in Insert mode.

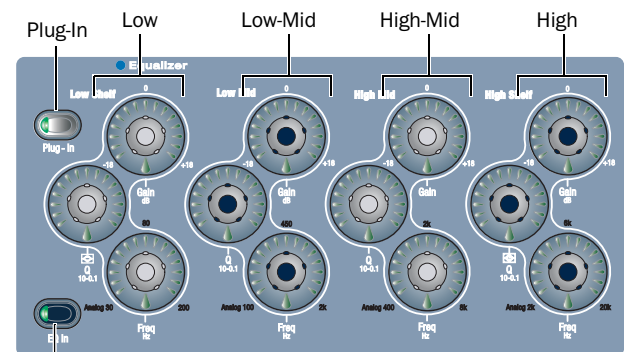

In/Out EQ controls in the ACS

**To adjust EQ parameters from the ACS:**

- 1 Target a channel by pressing its Select switch.
- 2 Press the EQ In switch to enable built-in EQ on that channel. The EQ In LED lights to indicate the EQ is engaged.)
- 3 Adjust the appropriate EQ encoder for High, Hi-Mid, Lo-Mid, or Low bands.

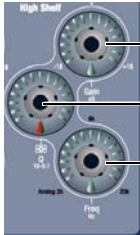

Gain (rotate) and Band In/Out (press)  
 Q (digital mode)  
 Frequency (rotate) and Bell/Shelf (press)

**High EQ controls in the ACS**

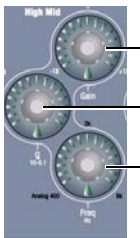

Gain (rotate) and Band In/Out (press)  
 Q (digital mode) or bandwidth (analog mode)  
 Frequency (rotate) and Bell/Shelf (press)

**Hi-Mid EQ controls in the ACS**

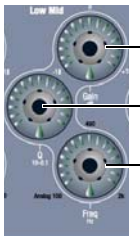

Gain (rotate) and Band In/Out (press)  
 Q (digital mode) or bandwidth (analog mode)  
 Frequency (rotate) and Bell/Shelf (press)

**Lo-Mid EQ controls in the ACS**



Gain (rotate) and Band In/Out (press)  
 Q (digital mode)  
 Frequency (rotate) and Bell/Shelf (press)

**Low EQ controls in the ACS**

**To toggle all bands in or out:**

- Press the EQ In switch.

**To reset an EQ parameter to its default value:**

- Hold the Default switch and adjust the control.

**To reset the entire EQ section (all bands) on a channel:**

- Hold the Default switch and press the EQ In switch.

**Software Screen EQ Controls**

You can adjust the built-in EQ using dedicated on-screen buttons for band in/out and bell/shelf toggling.

The software screen also provides the EQ Graph display to adjust frequency and gain simultaneously.

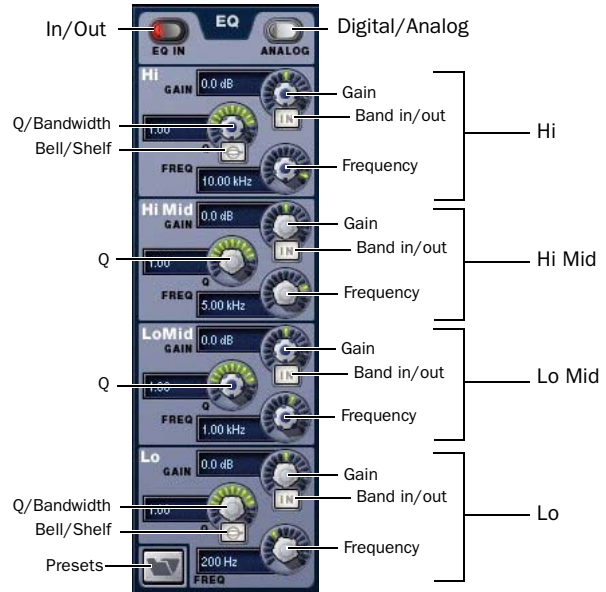

**EQ controls in the software screen (4-band Input Channel EQ shown)**

**To adjust parametric EQ parameters on-screen:**

- 1 Select a channel on-screen.
- 2 Click the EQ In switch to put the EQ in circuit.
- 3 Adjust the on-screen controls by doing one of the following:
  - Turn an on-screen knob (Gain, Q/Bandwidth, or Frequency) for each frequency band.
  - Click to toggle any on-screen EQ switch (EQ in/out, band in/out, or bell/shelf).
  - Click a displayed value and type a new value.
  - Drag up or down in a value display to increase or decrease the value.

**To reset an on-screen EQ parameter to its default value, do one of the following:**

- Alt-click the control (or, hold the console Default(Alt) switch and click the control).
- Right-click the control and choose Reset.

**To reset the entire EQ section (all bands) on a channel, do one of the following:**

- Right-click anywhere in the EQ section on-screen (but not directly on an encoder or button) and choose Reset EQ Section.
- Hold Default and click the on-screen EQ In button.

## Using the EQ Graph Display

The on-screen EQ graph lets you use the mouse to adjust frequency and gain for any available EQ band.

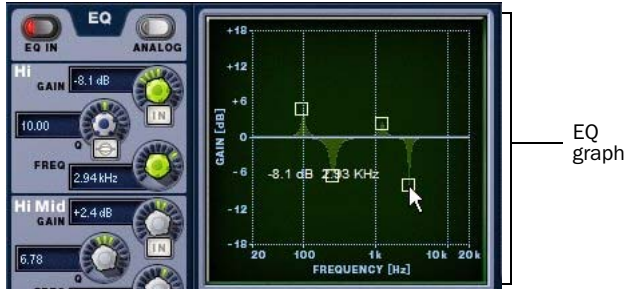

Dragging handles in the EQ graph display

### To adjust EQ on-screen using the Graph display:

- 1 Select a channel on-screen.
- 2 Click the EQ In switch to put the EQ in circuit.
- 3 Drag the handles in the on-screen EQ graph display for each EQ band (Lo, Lo-Mid, Hi-Mid, or Hi), as follows:
  - Drag a handle right or left to increase or decrease frequency.
  - Drag a handle up or down to increase or decrease gain.

## Adjusting EQ Plug-Ins

EQ plug-ins can map their gain, frequency, and Q/bandwidth controls to corresponding encoders in the ACS.

When a plug-in provides additional parameters beyond those that map to the dedicated EQ encoders, you can use the Output encoders.

 All plug-ins, including EQ plug-ins that do not map directly to dedicated EQ encoders, can be controlled using the Output encoders in Insert mode.

### To adjust an EQ plug-in from the console:

- 1 Target the channel with the plug-in by pressing the channel Select switch.
- 2 Press the plug-in Select switch in the ACS.
- 3 Do one of the following:
  - If the EQ plug-in maps correctly, adjust parameters by pressing or turning the corresponding encoders in the ACS EQ section.
  - If the EQ plug-in does not map to the ACS controls, press the Insert Mode switch in the Output section. Use the Output encoders to adjust parameters; use the Previous Page and Next page switches to access other pages, bands, and parameters.

 For more information, see Chapter 18, “Plug-Ins.”

## Channel Modes Affecting EQ

The following features affect operation of built-in EQ.

### Dyn Pre EQ

By default, built-in Dynamics processing occurs before built-in EQ processing in the signal chain of input channels. This can be changed on a per-channel basis by toggling the channel's Dyn Pre EQ setting.

#### To toggle the Dyn Pre EQ setting of an input channel:

- 1 Target the channel whose Dyn Pre EQ mode you want to change by pressing its Select switch.
- 2 In the on-screen channel Config section, click the Dyn Pre EQ switch. When enabled, the Dyn Pre EQ switch LED lights.



Dyn Pre EQ button

### Input Direct Mode

Input Direct mode lets you bypass the built-in dynamics and EQ processing, and all inserts on Input Channels and FX Returns.

#### To toggle Input Direct model:

- 1 Target the input channel by pressing its Select switch, and make sure the Inputs page is displayed.
- 2 Click the Input Direct button in the channel Config section in the upper right corner of the screen. When enabled, the Input Direct LED lights.

## Graphic EQ for Outputs

A built-in 31-band Graphic EQ can be inserted on Mains, Groups, Auxes, Matrixes, and PQs. The Graphic EQ provides +/- 12 dB of gain and constant Q.

Assigning a Graphic EQ to a mono channel uses one available Graphic EQ. Assigning a Graphic EQ to a stereo channel uses two available Graphic EQs.

Graphic EQs can be adjusted on-screen, or using the input faders, which provide access to two banks of 16 frequency bands each.

## Configuring Graphic EQs

To configure the number of Graphic EQs:

- 1 Put the system into Config mode.
- 2 Go to the Options page and click the System tab.
- 3 Click the Edit button on-screen.
- 4 Choose the number of Graphic EQs from the pop-up menu. You can choose to dedicate processing resources to provide 0, 8, 16, or 24 Graphic EQs.

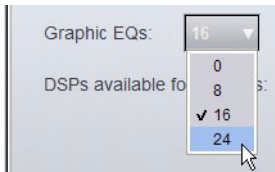

Configuring the number of Graphic EQs

## Inserting Graphics EQs on Outputs

To insert a Graphic EQ on an Output bus:

- 1 Target the bus by pressing its Select switch.
- 2 In the Outputs page, click the 31-Band Graphic Equalizer tab.
- 3 Click the Graphic EQ pop-up menu and choose an available mono or stereo Graphic EQ.

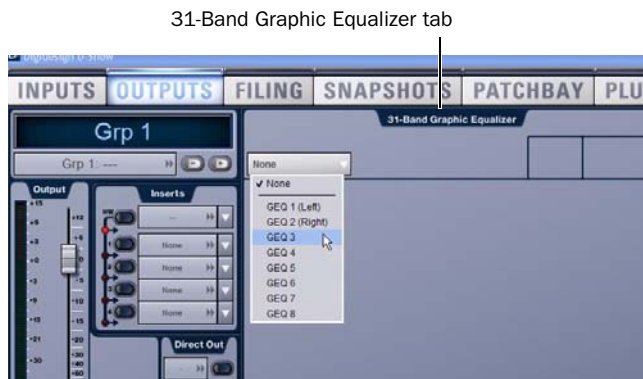

Assigning a graphic EQ (mono)

The 31-Band Graphic EQ appears on-screen.

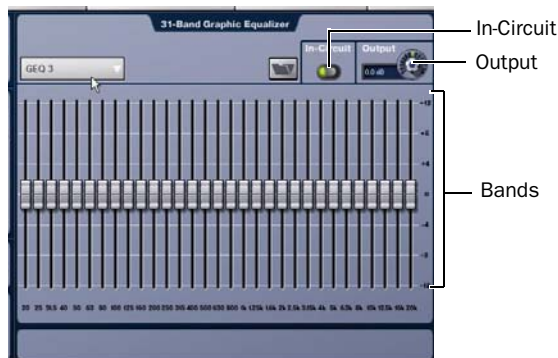

31-band graphic EQ

## Graphic EQ Controls

Input faders 1-16 provide control of Graphic EQ frequency bands. You can also adjust graphic EQs on-screen.

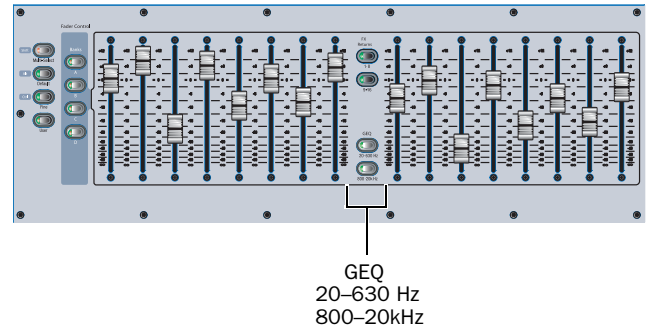

Input fader banking and assignment switches

To enable the graphic EQ:

- 1 Target an Output bus with a Graphic EQ assigned. If no graphic EQ is assigned, display the 31-Band Graphic Equalizer tab in the Outputs page and assign one using the Graphic EQ pop-up menu.
- 2 Click the In button on-screen to toggle in/out status. When enabled, the In/Out switch LED lights.

To set a graphic EQ curve:

- 1 Press the Graphic EQ band switch or click on-screen to select the appropriate bank of graphic EQ bands: (20 to 630 Hz, 800 Hz to 20 kHz). Inputs 1–16 are temporarily replaced with frequency fader controls.
- 2 Adjust one of the 16 faders controlling the selected graphic EQ bands.
- 3 Press another Graphic EQ band switch or click on-screen to select another bank of graphic EQ bands and adjust as needed.

To adjust graphic EQ gain:

- Press the GEO 800–20kHz switch, then adjust the last encoder above that bank of GEO faders, or use the on-screen Output control.

## Resetting Graphic EQ Parameters

To reset a band to its default setting, do one of the following:

- Hold the Default switch and press the Select switch on the fader corresponding to the graphic EQ band.
- Right-click the individual band fader on-screen and choose Reset.
- Alt-click the band on-screen.

To reset the entire graphic EQ to flat:

- Right-click anywhere in the Graphic EQ section on-screen (but not directly on a fader) and choose Reset GEQ Section.



## EQ Settings and Presets

Built-in parametric and Graphic EQ settings can be copied and pasted between channels. EQ presets can also be saved and loaded to archive and transfer settings.

### Copying and Pasting EQ Settings

**To copy and paste an EQ setting:**

1 Do one of the following:

- To copy a parametric EQ setting, right-click the on-screen EQ section or EQ graph (not on an encoder) and choose Copy EQ Settings.

– OR –

- To copy a Graphic EQ setting, right-click the graphic EQ display (not on a fader) and choose Copy GEQ Settings.



EQ Reset/Copy/Paste pop-up menu

2 Go to the channel where you want to paste the settings.

3 Do one of the following:

- To paste a parametric EQ setting, right-click in the new channel's EQ section or graph and choose Paste EQ Settings.

– OR –

- To paste a Graphic EQ setting, right-click in the new channel's Graphic EQ section and choose Paste GEQ Settings.

### Presets for Built-In and Graphic EQ

You can store and load EQ settings to disk as Preset files. Presets can be used with built-in and plug-in EQ processors, including the graphic EQ. Preset files can be moved between systems and used for other Shows. Presets can be accessed from the control surface or on-screen.

 Check the Factory Presets folder for preconfigured settings.

**To save or load a preset:**

1 Adjust EQ parameters as needed.

2 Click the EQ Presets icon on-screen. (The Presets icon is available in the Inputs screen EQ section, and in the graphic EQ screen for an output channel).

3 Choose a Presets folder in the Folder display at the top of the Presets window. If necessary, choose the appropriate Presets folder by selecting it from the Folder pop-up menu.

 For more information, see Chapter 20, "Shows and File Management."



Presets window

Presets icon

#### EQ Presets window

4 Do any of the following:

- To preview an existing preset, click its name in the Presets window.
- To load the currently selected preset, press Enter or click the Close box in the Presets window title bar.
- To load a preset and close the Presets window, double-click the preset.
- To save the current EQ settings as a new preset, click New and enter a name for the preset file.
- To cancel without changing settings, click Cancel.

**To save or load a preset for the Graphic EQ:**

1 Go to the Outputs page for the channel on which the graphic EQ is assigned. If necessary, click the 31-Band Graphic Equalizer tab to display the graphic EQ on that channel.

2 Click the Presets icon (above the EQ bands, next to the In-Circuit button).

3 Choose a Presets folder in the Folder display at the top of the Presets window. If necessary, choose a different Presets folder by clicking and selecting it from the Folder pop-up menu.

4 Do any of the following:

- To preview an existing preset, click its name in the Presets window.
- To load the currently selected preset, press Enter or click the Close box in the Presets window title bar.
- To load a preset and close the Presets window, double-click the preset.
- To save the current graphic EQ settings as a new preset, click New and enter a name for the preset file.
- To cancel without changing settings, click Cancel.



## Control Ranges for Built-In Parametric EQ (All Modes)

Table 18. Control ranges for built-in parametric EQ

Band	Control	Range (Digital)	Defaults (Digital)	Range (Analog)	Defaults (Analog)
High (Bell/Shelf)	Frequency	20 Hz to 20 kHz	10 kHz	2 kHz to 20 kHz	6 kHz
	Gain	±18 dB	0 dB	±15 dB	0 dB
	Q/Bandwidth	10 to 0.1	1.0	Shelf only	none
High-Mid	Frequency	20 Hz to 20 kHz	5 kHz	400 Hz to 8 kHz	2 kHz
	Gain	±18 dB	0 dB	±15 dB	0 dB
	Q/Bandwidth	10 to 0.1	1.0	0.1 to 2.0 octaves	0.2
Low-Mid	Frequency	20 Hz to 20 kHz	1 kHz	100 Hz to 2 kHz	450 Hz
	Gain	±18 dB	0 dB	±15 dB	0 dB
	Q/Bandwidth	10 to 0.1	1.0	0.1 to 2.0 octaves	0.2
Low (Bell/Shelf)	Frequency	20 Hz to 20 kHz	200 Hz	30 Hz to 200 Hz	80 Hz
	Gain	±18 dB	0 dB	±15 dB	0 dB
	Q/Bandwidth	10 to 0.5	1.0	Shelf only	none

## Fader Banks and Graphic EQ Frequency Bands

VENUE Profile Fader Banks and Graphic EQ Frequency Bands

<b>Bank 1</b> (20 to 630 Hz)								
<b>Fader</b>	1	2	3	4	5	6	7	8
<b>Freq</b>	20 Hz	25 Hz	31.5 Hz	40 Hz	50 Hz	63 Hz	80 Hz	100 Hz
<b>Fader</b>	9	10	11	12	13	14	15	16
<b>Freq</b>	125 Hz	160 Hz	200 Hz	250 Hz	315 Hz	400 Hz	500 Hz	630 Hz
<b>Bank 2</b> (800 Hz to 20 kHz)								
<b>Fader</b>	1	2	3	4	5	6	7	8
<b>Freq</b>	800 Hz	1000 Hz	1.25 kHz	1.6 kHz	2 kHz	2.5 kHz	3.15 kHz	4 kHz
<b>Fader</b>	9	10	11	12	13	14	15	16
<b>Freq</b>	5 kHz	6.3 kHz	8 kHz	10 kHz	12.5 kHz	16 kHz	20 kHz	n/a



# Chapter 18: Plug-Ins

This chapter explains how to install and configure plug-ins before a performance, and how to use plug-ins during a performance.

Plug-Ins can be inserted on all channels and bus outputs, or used as bus processors for effects such as reverb and delay.

 For complete information on VENUE-compatible plug-ins, visit the Avid website ([www.avid.com](http://www.avid.com)).

## Plug-Ins Quick Start

Before a performance, enable Config mode and do the following:

- Install plug-ins (see “Installing and Authorizing Plug-Ins” on page 151).
- Assign plug-ins to racks and rack slots (see “Plug-In Racks” on page 156).
- Assign plug-in input and output routing, including side-chain routing (see “Assigning and Routing Plug-Ins” on page 159).
- View and adjust plug-ins using the console or software screen (see “Adjusting Plug-Ins” on page 161).
- Save and load plug-in settings as Presets, or with snapshots (see “Plug-In Presets and Snapshots” on page 164).

During a performance, do all of the following:

- Enable Show mode to “safe” (lock out) plug-in rack assignments and other plug-in rack operations that could interrupt a performance.
- Patch channels and busses to available plug-ins, re-assign plug-in routing, or re-assign existing side-chain routing.
- Adjust plug-in parameters from the ACS, Output Encoders, or on-screen.
- Save and load plug-in settings as Presets, or within snapshots.

## Using Config and Show Modes for Plug-Ins

The current Console mode status (Config or Show mode) determines which plug-in functions are available.

Config mode is required to install plug-ins, assign them to rack slots, and to establish side-chain routing. When in Show mode, any operations that might interrupt audio throughput are locked out and unavailable.

 *Plug-In actions that interrupt audio require Config mode. For more information, see “Config Mode and Show Mode” on page 40.*

---

## Installing and Authorizing Plug-Ins

Plug-ins can be installed and authorized on systems using their installer discs or USB storage devices. (Plug-ins are not able to be installed or adjusted using only the Standalone software.)

 *Because installing plug-ins can interrupt audio throughput, always install plug-ins before a performance.*

## Installing Plug-Ins

**To install a plug-in:**

- 1 Put the system into Config mode.
- 2 If installing from a CD-ROM, insert the installer disc into the system CD-ROM drive.
- 3 Go to the Options page and click the Plug-Ins tab. The following two lists are shown:

**Plug-Ins to Install** This list shows available plug-in installers. At the top of the list is the Device selector, which provides a pop-up menu of available media sources. Plug-In installers are stored locally after plug-in installation, and appear as available items when Previous Installs is selected from the Device selector. This lets you re-install plug-ins without the original CD-ROM or other media.

**Installed Plug-Ins** This list shows all plug-ins already installed on the system. The plug-ins shown in plain text are available to process audio. Plug-Ins listed in italics are disabled and unavailable (see “Enabling and Disabling Installed Plug-Ins” on page 154).

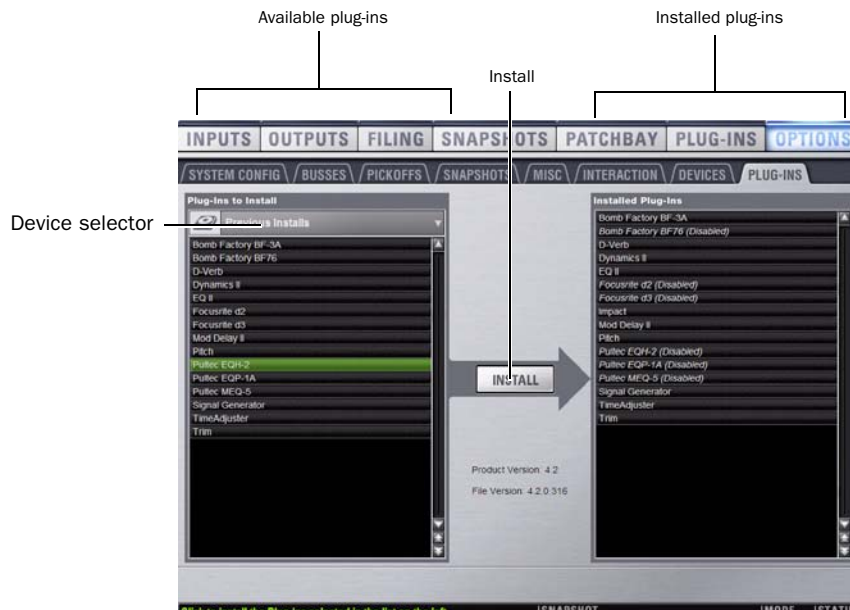

Figure 14. Options > Plug-Ins screen

4 Click the Device Selector pop-up menu and do one of the following:

- Choose Previous Installs to access any plug-in installers after a system update.
- Choose Console to access all factory-installed plug-in installers. after a system update or a full system restore.
- Choose an external storage device, as available, to access plug-in installers loaded in the CD-ROM drive.



#### Choosing a Device

5 Select a plug-in from the Plug-Ins to Install list on the left by doing any of the following:

- Click to select a single installer.
- Shift-click to select multiple contiguous installers.
- Control-click to select or deselect installers one at a time.

6 Click Install to install the selected plug-ins. Once installed, the plug-in appears in the Installed Plug-Ins list on the right.

7 Repeat as necessary to re-install all plug-ins needed on the system.

## Installing Plug-Ins Manually

If a plug-in does not appear in the Plug-Ins to Install list, it may not have a fully compatible VENUE installer and must be manually installed. This is required the first time you install the plug-in, and whenever you need to re-install a plug-in (such as after using the System Restore CD to update or reset the system).

 A plug-in without a VENUE installer may still be compatible. Consult the plug-in manufacturer for compatibility information.

#### To install a plug-in manually:

- 1 Make sure all sound systems are shut down or muted.
- 2 Insert the plug-in installer disc into the CD-ROM drive.
- 3 Go to the Options page and click the System tab.
- 4 Hold the Ctrl key and click Shutdown Console on-screen. Follow on-screen directions to exit to the Desktop.
- 5 Copy the plug-in installer to the partition named User Data.
- 6 Launch the plug-in installer application and follow any on-screen directions. If prompted, do not restart the system from a plug-in installer. (Doing so will not harm the system, but will take longer, especially if you have multiple plug-ins to install manually.)
- 7 Quit the installer application and eject the installer disc.
- 8 Click the Return to D-Show shortcut on the desktop to re-launch the VENUE software.
- 9 Go to the Options page and click the Plug-Ins tab. Verify that the manually installed plug-in appears in the Console list of available plug-ins.

## Authorizing Plug-Ins

After installing a plug-in, the system re-creates the list of available plug-ins. Whenever the racks initialize, the system checks authorizations for all installed plug-ins. If no previous authorization for a plug-in is recognized, you will be prompted to try a demo version, or authorize the full version of the plug-in.

VENUE software supports challenge/response and iLok USB Smart Key authorization, including pre-authorized iLoks and iLok Authorization cards.

**Challenge/Response** Challenge/response authorization is only valid for the single system the plug-in is currently installed on. Challenge/response codes can be communicated using any computer with Internet access.

**⚠** *It is not possible to connect a VENUE system to the Internet directly.*

**iLok USB Smart Key** Plug-Ins supporting web authorizations through iLok.com can be authorized for your iLok Smart Key from any computer with Internet access. This lets you take your iLok and your plug-in authorizations anywhere, to use plug-ins installed on any system.

**💡** *VENUE systems provides multiple USB ports that can be used to connect an iLok. For more information, see Chapter 2, “Configuring and Connecting Profile.”*

### To authorize a plug-in:

1 When a plug-in authorization dialog appears, do one of the following:

- To try a demo of the plug-in, click Try.
- or –
- To have the system recognize the required authorization on your iLok, click Authorize. Insert your iLok Smart Key into any available USB port when prompted.

**⚠** *Do not choose Internet Activation. Use Challenge/Response or an authorized iLok Smart Key for plug-in authorization.*

2 Follow the instructions on-screen to complete the software authorization process.

## Managing Plug-Ins on the System

To keep your system up to date and running smoothly, always the current recommended versions of your plug-ins.

Use the following features to check and maintain plug-in compatibility, to disable plug-ins, and how to remove and delete plug-ins and their installers.

### Plug-in Version Checker

VENUE software includes a comprehensive database of plug-in version and compatibility information that can help you maintain current versions of all your plug-ins. It also lets the system warn you when you are about to downgrade a plug-in (install an older version over a newer version).

**💡** *See the VENUE plug-in pages on the Avid website ([www.avid.com](http://www.avid.com)) for the most up to date information.*

### To view plug-in version information:

- 1 Go to the Options > Plug-Ins page.
- 2 Select a single plug-in from the Plug-Ins to Install or Installed Plug-Ins list (version information is not shown for a multi-selection).

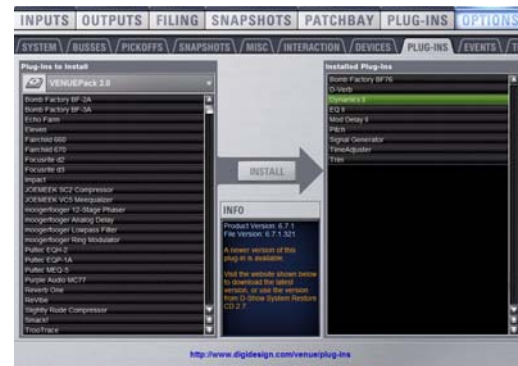

### Info about a recommended update in Options > Plug-Ins

The Info pane shows details about the currently selected plug-in, including whether a newer version of the plug-in is available and whether it is a recommended update or a critical update.

If you choose to install a plug-in for which there is a critical or recommended update, the system asks you to confirm.



**Dialog shown when attempting to install a plug-in that has a known newer version.**

A similar dialog appears when attempting to replace an installed plug-in with an older version of the same plug-in. Follow the instructions on-screen to install anyway, or cancel.

### Using System Info to View Plug-in Version Information

Plug-in version information is included in exported System Info data. The Plug-in sections of the exported System Info file show critical and recommended updates, with links to sites to download or check for newer versions.

#### To use System Info for Plug-In Version Maintenance:

- 1 Insert a USB key disk into an available USB port.
- 2 Go to the Options > System page.
- 3 Click the Info button.

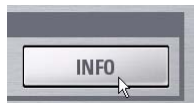

Export VENUE System Information button in Options > System

- 4 Do any of the following:
  - If you have more than one USB key disk connected, make sure the correct USB key disk is selected. If it is not, click Next Disk to cycle through each available disk until the correct one is selected.
  - Click Save to proceed and export system info to the selected USB disk.
  - Click Cancel to dismiss the dialog without exporting.
- 5 Click OK to confirm the export procedure.
- 6 Remove the USB key disk.

You can now transfer the exported file to a personal computer for printing, formatting, archiving or distribution. If viewing the System Info document from a computer with internet access, use the included links to check for plug-in updates.

### Automatic Plug-ins Cleanup During Show Load

Plug-ins are verified while Show files are loaded to streamline plug-in lists and menus. Unused plug-ins (plug-ins that were once installed but subsequently uninstalled or disabled) are identified, and will appear in lists and menus *italicized*.

At any time, the plug-in lists can be reset manually using the Remove Unavailable Plug-ins command. This command results in the following:

- Plug-ins that are not available and not in use in the rack are automatically filtered from plug-in menus when the show file is stored. This filtered list is saved with the Show file.
- Plug-ins that are not available but are in use remain in the rack and display a warning icon in their rack slot, and are listed *italicized* in plug-ins menus.

## Enabling and Disabling Installed Plug-Ins

The Installed Plug-Ins list shows Disabled plug-ins in *italics*. Plug-Ins can be manually disabled and enabled to manage DSP resources, troubleshoot possible conflicts, and to manage plug-in availability.

#### To globally disable or enable a plug-in:

- 1 Click to select the plug-in name in the Installed Plug-Ins list, at the right of the Options > Plug-Ins tab.
- 2 Right-click the plug-in and select whether to disable or enable the selected plug-in.

If assigned to any rack slots, the plug-in will be displayed as unavailable and inactive.

## Removing and Deleting Plug-Ins and Installers

Removing a plug-in “uninstalls” the plug-in from the racks, but its installer remains in the Previous Installs cache, making it easier to reinstall the plug-in at a later time without requiring the installer CD or other media. (See “Removing Plug-Ins” on page 154.)

Deleting a plug-in completely removes it and its installer from your system. (See “Deleting Uninstalled Plug-Ins” on page 155.)

The list of plug-ins you see in VENUE software is updated automatically each time you load a Show file to keep plug-in lists and menus uncluttered.

You can also remove or delete plug-ins and/or their installers manually.

 *Installing, uninstalling, and deleting plug-ins are not supported using the Standalone software.*

### Removing Plug-Ins

#### To uninstall a plug-in from the system but leave its installer available:

- 1 Put the system in Config mode.
- 2 Go to the Options page and click the Plug-Ins tab.

3 Right-click the specific plug-in name from the right-hand list and choose the Uninstall option for the selected plug-in.

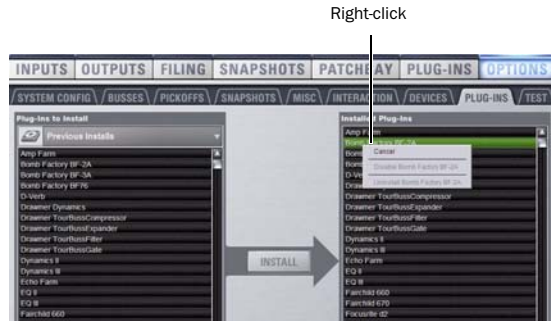

Uninstalling a plug-in

### Removing Unavailable Plug-ins from the Racks

Unavailable plug-ins can be removed from rack slots using the Remove Unavailable Plug-Ins command.

#### To manually remove unavailable plug-ins:

- 1 Put the system in Config mode.
- 2 Make sure the plug-in rack is fully initialized (the Status indicator displays OK).
- 3 Click the Plug-In selector in any rack slot and choose Remove Unavailable Plug-Ins. This menu item is only available when one or more unavailable plug-ins are present in the rack.
- 4 Click Remove to proceed, or click Cancel. If you proceed with the removal:
  - All unavailable plug-ins are removed from the rack.
  - Italicized entries for unavailable plug-ins are removed from all plug-in menu lists.
  - All references to unavailable plug-ins are removed from the Insert Processing section of all affected channels, and the insert point plug-in is set to None.
  - All references to unavailable plug-ins are removed from all snapshots.

The new, updated list of available plug-ins is subsequently saved to the Show file.

### History File and Removing Plug-ins

A History file is written immediately before removing unavailable plug-ins from the rack, letting you recall that History file to revert the system to its state prior to removing plug-ins.

### Reinstalling a Removed Plug-in

#### To reinstall a removed plug-in:

- 1 Put the system in Config mode.
- 2 Go to the Options page and click the Plug-Ins tab.

3 Click the Device selector and choose Previous Installs.

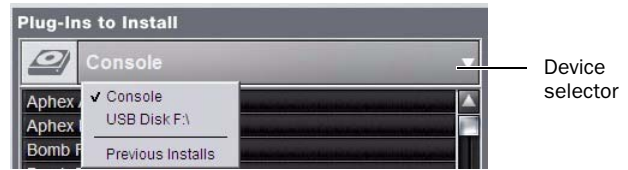

#### Choosing a Device

4 Select the plug-in and choose Install. If the desired plug-in is not listed, it must be re-installed from the original CD-ROM or other media.

### Deleting Uninstalled Plug-Ins

Once a plug-in is uninstalled, its installer can be deleted from the system. (Plug-ins which are currently installed cannot be deleted).

#### To completely remove a plug-in and its installer:

- 1 Put the system in Config mode.
- 2 Go to the Options page and click the Plug-Ins tab.
- 3 Select Previous Installs from the Device selector.
- 4 Right-click the plug-in name and choose the Delete option for the selected plug-ins. The plug-in is removed from the system, and the stored plug-in installer is removed from the Previous Installs list.

## Overview of Working with Plug-Ins

The Plug-Ins screen displays the plug-in Racks, where the majority of plug-in features are located.

#### To access the Plug-Ins page:

- Press the Plug-Ins switch in the View Mode section (or click the Plug-Ins tab). By default, the Plug-Ins page displays all four racks, which are empty until plug-ins have been assigned. (See also “Jump To” Plug-Ins” on page 163.)



Plug-In racks (no plug-ins assigned)

You populate the racks by *assigning* plug-ins in rack slots. During a performance, plug-ins that have been assigned in rack slots can be inserted on channels and routed to/from busses on-screen. Plug-in parameters can then be adjusted from the console as well as on-screen.



## Plug-In Racks

The Plug-Ins page provides four plug-in racks. Each of the four racks has 25 slots into which you can load a plug-in. The four different racks can be viewed all at once, individually, and in varying zoom levels.



Figure 15. Plug-In racks and rack slots, Main view, with custom rack names shown.

### Naming Plug-In Racks

By default, the racks are named Rack 1, Rack 2, Rack 3, and Rack 4. You can rename each rack as needed.

#### To rename a plug-in rack:

- 1 Double-click the rack name to highlight it on-screen.
- 2 Type a new name and press Enter. To return a rack to its default name, leave the name blank and press Enter.

 *Plug-Ins can be placed in any rack slot. Use the different racks to organize processing functions such as Dynamics, EQ, Reverb, or Group Inserts.*

### Rack Views

The Plug-Ins page can be displayed in Full or Zoom views, with the option to display either view in Mini-view mode.

#### Full View

The default view of the rack screen is Full view, in which all four racks are shown (see Figure 15). This screen provides access to all rack slot controls, and shows an icon representing each assigned plug-in. This lets you quickly see what plug-ins are available, and adjust their routing.

## Zoom View (Plug-In View Mode)

In Zoom view, a single rack remains on-screen to the left, and the rest of the screen displays the targeted plug-in.

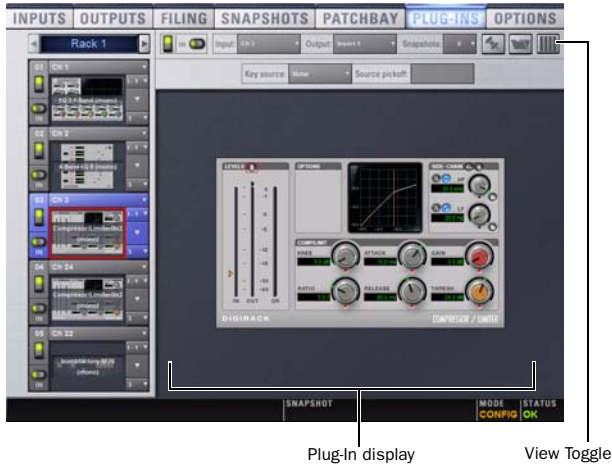

Zoom view, with a plug-in window open on-screen

To toggle Full or Zoom view modes, do one of the following:

- Press the Plug-Ins switch (in the View Modes section), or click the View toggle switch (upper right corner of the rack).

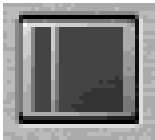

Zoom/Full view toggle

– or –

- Double-click a plug-in icon in any rack view to open that plug-in window in Zoom view.

 *VENUE provides other ways to jump to a plug-in view. For more information, see “Jump To” Plug-Ins” on page 163.*

## Mini-View Mode

Mini-view mode is an option available in Full and Zoom modes in which the rack slot displays are minimized and plug-in icons are hidden, to let you see more of the racks at one time. You can still bypass, route, and work with plug-in snapshot controls in Mini-view mode.

To toggle mini-view on or off:

- Click the Mini-view icon (upper left corner of the rack view).

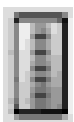

Mini-view

## Identifying Rack Slots

The racks indicate which plug-in is currently targeted by highlighting its rack slot controls in blue.

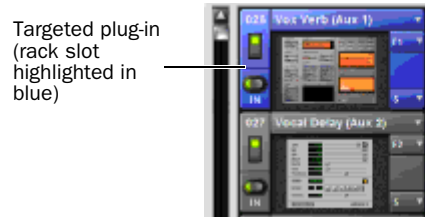

Highlighted rack slot indicating targeted plug-in

Within each rack slot, color outlines appear around each plug-in to indicate the type of plug-in currently targeted on the control surface. The following colors are used:

### Outline Color Coding of Rack Slots

Color Outline	Indication
Green	An EQ plug-in is mapped to the console
Blue	A Comp/Lim plug-in is mapped to the console
Yellow	An Exp/Gate plug-in is mapped to the console
Red	A plug-in is mapped to the Assignable Output Encoders (Insert mode)

## Display of Unavailable or Inactive Plug-Ins

It is possible for a plug-in to be displayed in a rack slot but be unavailable for channel and bus processing. This can occur in any of the following circumstances:

- There is not enough DSP available for the plug-in.
- The assigned plug-in is part of the show file but is not installed on the current system.
- The plug-in has been disabled manually.

 To view DSP resource allocation, see “DSPs Available for Plug-Ins” on page 58.

### Unavailable Plug-Ins

When a plug-in cannot be used due to insufficient DSP resources, because it is disabled, or because it is not installed, a warning icon appears in front of that plug-in. The plug-in icon is dimmed, and the rack slot Power switch has a yellow LED.



Unavailable plug-in

Indication of an unavailable plug-in

For more information, see “Installing and Authorizing Plug-Ins” on page 151.

## Inactive Plug-Ins

When a plug-in has been manually made inactive, the plug-in icon is greyed out. Plug-Ins can be made inactive manually, letting you retain their assignment and settings in the rack while freeing up their DSP resources for other tasks.

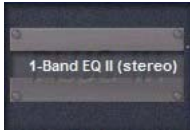

Indication of an inactive plug-in

For more information, see “Active and Inactive Plug-Ins” on page 160.

## Scope Indication in the Plug-Ins Page

The Plug-In Rack provides visual indication whenever a plug-in is scoped in the currently targeted snapshot. The Snapshot pop-up menu turns red whenever that plug-in is scoped by the currently targeted snapshot.



Scoped (Snapshot menu red)

Indication of a scoped plug-in

For more information, see “Plug-In Presets and Snapshots” on page 164.

## Rack Slots

Each rack provides 25 plug-in slots. You can assign any installed plug-in to any available rack slot.

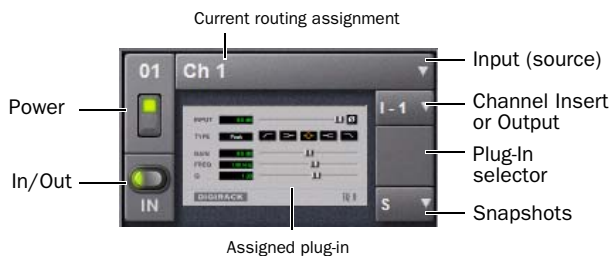

A rack slot and its controls, with an assigned plug-in shown

Each rack slot provides the following controls to select and manage plug-ins:

### Power (Config Mode Only)

Power turns the rack slot on or off. When off, the plug-in consumes no DSP.

## In/Out (bypass)

The In/Out switch takes the rack slot in or out of circuit (bypasses the slot and any plug-in assigned to it).

## Input

The Input pop-up menu determines plug-in input (source). Use this menu to designate the plug-in as a channel insert or a bus processor by choosing from the Inserts or Bus sub-menus. For more information, see “Routing Plug-Ins” on page 160.

Once a plug-in has been routed, its input source is displayed in the Input area of each rack slot, as follows:

- If the plug-in is being used as an insert, the channel or bus name and number is shown, for example, *Kick (Ch 1)* or *Aux 1 (1–2)*. The Channel Insert/Bus Output selector automatically switches to Channel Insert mode, showing the insert point occupied by the plug-in.
- If the plug-in is on a bus, the selected bus source is shown in the Input selector, for example, *Aux 1* or *Grp 1*. The Channel Insert/Bus Output selector can be used to assign the output routing of the plug-in to a channel or bus.

## Channel Insert or Bus Output

The Channel Insert/Bus Output pop-up menu displays different choices depending on whether the plug-in is being used as a channel insert, or as a bus processor, as follows:

- If the plug-in is being used as a channel insert, the Channel Insert selector shows the four insert points on that channel (1–4). The letter “I” is shown before the insert number (for example, I-1 indicates the current plug-in is inserted into the first insert position on its channel).
- If the plug-in is being used as a bus processor, the menu becomes the Output selector used to select the destination for plug-in output.



Channel Insert

Bus Output

A mono plug-in inserted on a channel (at left) and a stereo plug-in assigned as a bus processor (at right)

## Plug-In Selector

The Plug-In selector displays a list of available plug-ins to load into that rack slot. Plug-Ins are arranged by process type (such as EQ, Dynamics, and Delay). For more information, see “Assigning and Routing Plug-Ins” on page 159.

## Snapshots Menu

The Snapshots menu provides tools to manage snapshot-related plug-in features from within the Plug-Ins screen. Using the Snapshots menu, you can quickly check to see which existing snapshots refer to the current plug-in, as well as create, update, or remove snapshots.

## Side-Chain Selector

The Side-Chain selector appears near the top of the Rack view when you select a plug-in that supports side-chain or “key” input. In Config mode, the Side-Chain selector lets you establish a side-chain routing to the plug-in. Once established, you can route and re-route side-chain signals in both Config and Show mode. For more information about side-chain signals, see “Side-Chain Routing” on page 161.

---

## Assigning and Routing Plug-Ins

Before you can use a plug-in as a channel insert or bus processor the plug-in must be assigned to a rack slot.

 Before a plug-in can be assigned, it must be installed. See “Installing and Authorizing Plug-Ins” on page 151.

## Assigning Plug-Ins to Rack Slots

To assign a plug-in:

- 1 Put the system into Config mode.
- 2 Go to the Plug-Ins page.
- 3 Click the Plug-In selector on an empty rack slot (or on an already assigned rack slot to change a plug-in assignment.)
- 4 Choose an available plug-in from the Plug-In selector sub-menus. Only plug-ins that are installed will be available.

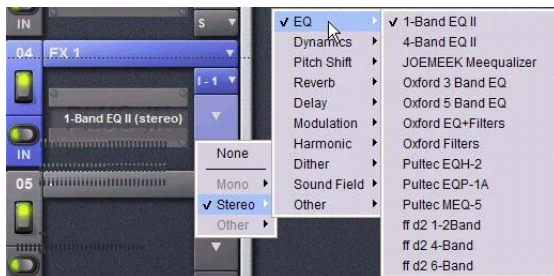

Plug-In selector menus

If the plug-in is not installed or there are insufficient DSP resources available, the plug-in will appear as unavailable, or inactive.

 Place the cursor over the plug-in to display a Tool Tip that explains why the plug-in is unavailable or inactive.

## Plug-In Formats

Plug-Ins inserted on channels must be symmetrical (in other words, mono in/out or stereo in/out). Plug-Ins on busses can be asymmetrical (mono-in/stereo or multichannel out).

**Mono** Can be used as inserts only in mono strips or mono Auxes, mono Groups, or Matrix busses or on the C/M bus.

**Stereo** Can be used as inserts in stereo strips, stereo-linked Auxes, stereo Groups, PQ busses (which are always stereo) and across the L–R busses.

**Other (Mono In/Stereo Out)** Can be used on busses for delay, reverb, and similar processing.

## Moving and Copying Plug-Ins

(Config Mode Only)

To move or copy a plug-in in the rack, drag the plug-in icon to a new rack slot. A pop-up menu appears offering three choices: Cancel, Copy Plug-In Here, or Move Plug-In Here.

### Moving a Plug-In

When you move a plug-in from one rack slot to another, the plug-in type, in/out state, power on/off, current plug-in settings, and routing are maintained. In addition, all associated snapshots are updated to reflect the new rack position.

### Copying a Plug-In

When you copy a plug-in to a new rack slot, the source plug-in type, in-circuit state, active state, and current plug-in settings are copied to the destination rack slot. However, the source plug-in routing is not copied. In addition, plug-in snapshots are not copied.

### Overwriting An Existing Plug-In

When either moving or copying, if there is an existing plug-in in the destination rack slot, that plug-in is deleted. When the plug-in in the destination rack is deleted, any routing or references to the deleted plug-in in existing snapshots will be automatically cleared.



## Active and Inactive Plug-Ins

To toggle the active/inactive state of a plug-in:

- Click the appropriate rack slot Power switch. When active, the Power switch is lit green. When a plug-in is unavailable (and inactive), the Power switch is lit yellow.



Indication of an inactive plug-in

## Routing Plug-Ins

After a plug-in has been assigned to a rack slot, you can specify its routing. Plug-In routing determines whether the plug-in is used as a channel insert or as a bus processor.

### Using Plug-Ins as Channel Inserts

Each channel provides four slots for channel inserts. Signal from the channel is routed to the insert and returned to the same channel. You can assign plug-ins to specific channel insert points from the Plug-Ins screen or from the Input screen.

To insert a plug-in on a channel from the Inputs or Outputs page:

- Go to the Input or Output screen.
- Click the first available Channel Insert selector and choose an available plug-in from the rack sub-menus. All currently available plug-ins of a compatible mono/stereo format are listed in the sub-menus. Plug-Ins that are unavailable are listed in *italics*. Plug-Ins that are already assigned as channel inserts are shown with their insert assignment.

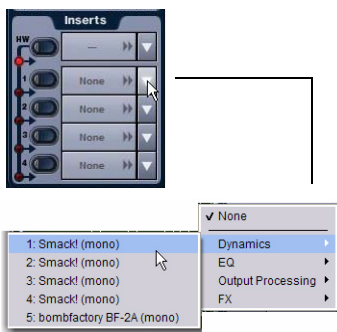

Clicking the Channel Insert selector (top)

- The plug-in appears in the Inserts list for that channel.
- To open the window for an inserted plug-in, click its name in the channel Inserts list.

To insert a plug-in on a channel from the Plug-Ins page:

- Make sure the plug-in is already assigned to a rack slot. (See “Assigning and Routing Plug-Ins” on page 159.)
- Click the Input (source) selector in the rack slot and choose a channel from its Inserts sub-menu.



Inserting a rack slot on a channel from the Plug-Ins page

The rack slot automatically identifies and connects to the first available insert slot (1–4) on the selected channel. The Channel Insert selector shows the current insert position.



Channel Insert selector for a plug-in rack

If no insert slots are available on the channel, the selector displays a question mark.

### Using Plug-Ins as a Bus Processor

Plug-Ins can be used on busses for send-and-return processing with effects such as reverb and delay. A plug-in is configured for bus processing by assigning an Aux, Group, Matrix, PQ or Mains bus (including Monitor output), or an input channel Direct Out, as the plug-in input source, then assigning the output of the plug-in to an input channel or FX return, or to a hardware output, as follows:

- Return bus-fed plug-ins to an input or FX Return to establish an effects send-and-return path.
- Route bus-fed plug-ins to a hardware output for specialized processing needs (such as feeding an external crossover).

You assign plug-ins for bus processing in the Plug-Ins screen.

To use a plug-in as a bus processor:

- Go to the Plug-Ins screen.
- Make sure the plug-in is installed and assigned to a rack slot.



A plug-in assigned to a rack slot

3 Click the Plug-In Input selector at the top of the corresponding rack slot, and choose an available bus from the Input sub-menus.

Plug-in Input selector



**Assigning plug-in Input source to a Group bus**

4 Click the Plug-In Output selector and choose a destination channel or bus.



**Assigning plug-in output**

When a bus-fed plug-in has both its input source and output assigned, it appears similar to the following in the rack:



A bus-fed plug-in in the rack

**Routing Channel Direct Outs to Plug-Ins**

You can route input channel Direct Outs to plug-ins. This lets you directly feed plug-ins from individual channels to preserve Aux busses for other uses, with control over send level using the channel Direct Out level control.



**Assigning a channel Direct Out as a plug-in input source in the Plug-Ins page**

When a channel Direct Out is routed to a plug-in, it follows the one global pickoff setting for that specific Direct Out (as set in the Patchbay), and is applied in addition to any other assignment made for that Direct Out. This makes it possible to use a channel's Direct Out to route that channel to both a Pro Tools recording option and to a plug-in.

**Side-Chain Routing**

VENUE systems support side-chain (key) processing for plug-ins that support side-chain triggering.

**⚠ Side-chain routing is not stored in snapshots.**

The Side-Chain selectors appear across the top of the plug-ins screen. You must be in Config mode to establish or remove a side-chain assignment. Once established, side-chain routing can be changed (but not added or removed) in Show mode.

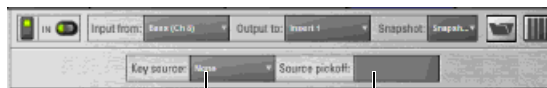

Click to select Key (side-chain) source  
Click to specify side-chain pickoff

**Side-Chain controls**

**To assign side-chain routing to a plug-in:**

- 1 Select a plug-in that supports side-chain processing.
- 2 Put the system into Config mode to display the Side-chain tools.
- 3 Choose the side-chain source signal from the Key Source pop-up menu.
- 4 Choose the pickoff point (tap) for the side-chain signal from the Source Pickoff pop-up menu.

**Adjusting Plug-Ins**

Plug-Ins can be selected and adjusted from the console or on-screen.

**On the Console**

VENUE Profile provides plug-in controls in the ACS and Output encoder sections for real-time interaction with plug-ins.

**Insert Processing**

The Insert Processing section lets you bypass, select, and target plug-ins inserted on the currently selected channel.

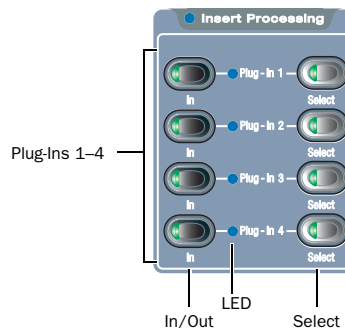

ACS Insert Processing section

## Dynamics

Dynamics plug-ins can be selected and adjusted in the Dynamics section in the ACS. (Dynamics and EQ plug-ins can be targeted on the ACS and Output encoders simultaneously).

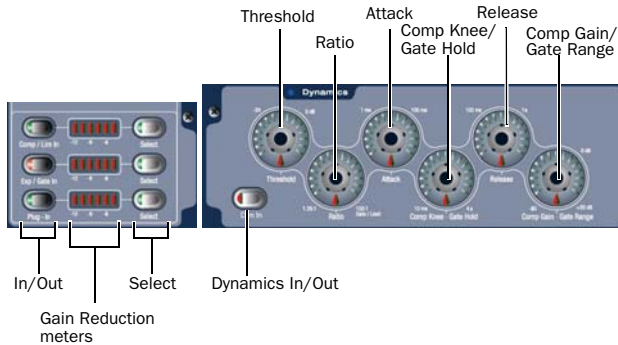

ACS Dynamics section and controls

## Equalizer

EQ plug-ins can be selected and adjusted with the controls in the EQ section in the ACS. (EQ and Dynamics plug-ins can be targeted on the Output encoders and ACS simultaneously).

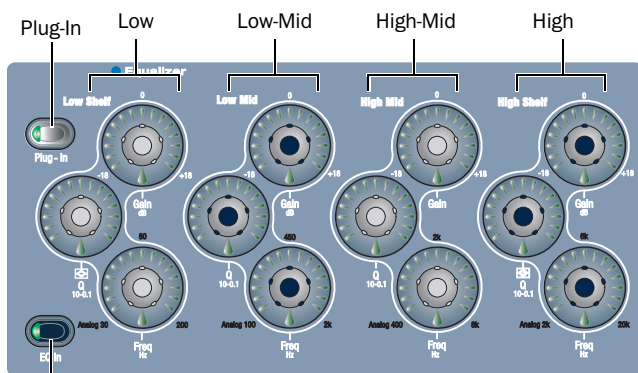

ACS EQ controls

## Output Encoders

The Output encoders can be placed into Insert mode to adjust any selected plug-in. Plug-in parameters map to the eight encoders and their switches; additional parameters are accessed with the Previous Page and Next Page switches.

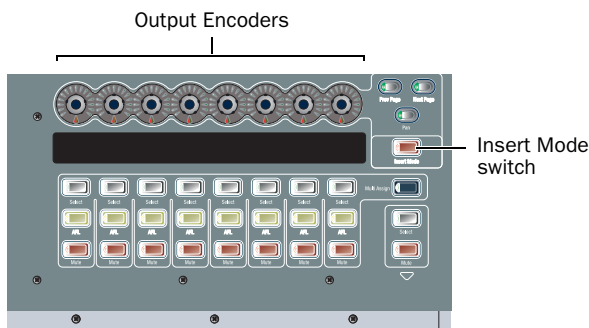

Encoders and Insert mode switch in the Output section

## To adjust a plug-in from the console:

- 1 Select the channel or bus on which the plug-in is inserted. To select a bus processing plug-in, bank to and select the FX Return or other channel assigned as the plug-in output.
- 2 In the Insert Processing section of the ACS, press the Select switch for the plug-in so that its switch is lit.
- 3 Press the Insert Mode switch, located near the Output encoders. The first page of plug-in parameters is mapped to the eight Output encoders.
- 4 To reset a parameter to its default value, hold the Alt key while rotating or pushing an encoder.
- 5 To adjust with greater resolution, hold the Ctrl key while rotating an encoder.
- 6 Press Previous Page or Next Page to bank to other plug-in parameters.

## Display of Plug-Ins in Insert Mode

While in Insert Mode, the Output LCD displays the value and name of the 8 currently banked plug-in parameters in the upper and lower row, respectively, for each parameter.

In this default Insert Mode view, adjusting an Output fader temporarily shows fader level in the lower row of the Output LCD for that channel, replacing the parameter name display.

## Alternate Insert Mode View

You can use an alternate view to have Insert Mode display parameter values in the upper row and the associated bus name in the lower row.

## To view values and bus names for the Output encoders in Insert Mode:

- Press Default/Alt+Insert Mode.

## Using the Source Switch

The Source switch toggles Input displays to show the names of bus-fed plug-ins routed to a channel. Use the Source switch to quickly identify which FX Returns or other channels are being used as plug-in returns.

## To view encoder values and bus names for Input or FX Return channels:

- Press the Source switch, located in the Display section to the left of the input Mute/Solo/Select switches.



## Bypassing Plug-Ins

### To bypass a plug-in from the console:

- 1 Select the channel on which the plug-in is inserted.
- 2 In the Insert Processing section of the ACS, press the In/Out switch for the plug-in to toggle it in-circuit/out-of-circuit. When the switch LED is lit, the plug-in is in-circuit. When unlit, the plug-in is out-of-circuit (bypassed).

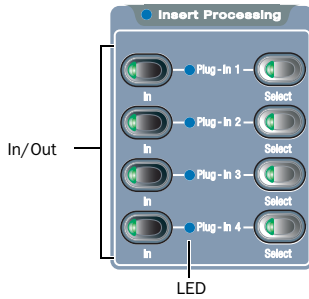

Insert Processing section

### To bypass a plug-in on-screen:

- 1 Select the channel on which the plug-in is inserted.
- 2 In the Inserts section of the Inputs or Outputs page, click the In/Out switch for the plug-in to toggle it in-circuit/out-of-circuit. When lit, the plug-in is in-circuit. When unlit, the plug-in is out-of-circuit (bypassed).

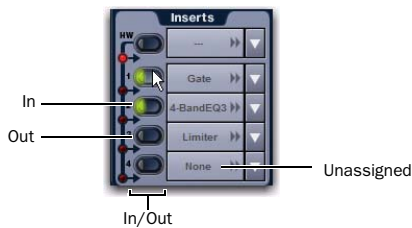

LED indication of in circuit and out of circuit (bypassed) inserts

## Plug-ins On-Screen

The software screen can be used to patch, route, or re-route plug-ins during a performance, even while in Show mode.

 *Plug-Ins must be installed on the system and assigned to a rack slot to be available while mixing. See “Assigning Plug-Ins to Rack Slots” on page 159.*

### “Jump To” Plug-Ins

The Input and Output screens let you “jump to” a specific plug-in insert to adjust it on-screen.

#### To jump to a plug-in insert from the Inputs or Outputs screen:

- 1 Select a channel to show it in the Inputs or Outputs page.
- 2 Click the plug-in name shown in the channel Insert section.



Jumping to a plug-in on a channel insert

#### To jump to a plug-in on a bus:

- 1 Bank to the FX Return or other channel type assigned as the plug-in output, or bank to the output feeding the plug-in.
- 2 Select the channel to display it in the Inputs or Outputs screen.
- 3 Click the routing displayed beneath the Channel Name.



Jumping to a plug-in on an FX Return

## Plug-Ins Screens and Channel Selection

When jumping to a plug-in, display depends on the type of plug-in routing, as follows:

**Channel Inserts** If the Plug-Ins screen is in Zoom view while you select a channel, the last selected plug-in for that channel is automatically selected and displayed in the Plug-Ins screen.

**Bus-Fed Plug-Ins** If no plug-ins are inserted on a channel (such as when returning a bus-fed plug-in to an FX Return) the plug-in feeding that FX Return is displayed.

## Pinning a Plug-In View

It is possible to decouple the plug-in view from the console for consistent and constant access to a single plug-in on-screen, while still being able to select and adjust other plug-ins from the console. This capability is useful any time you want to always display an important plug-in (such as an analysis plug-in or primary EQ).

### To pin a plug-in view:

- 1 Bring the desired plug-in into the main plug-in view (use the channel Select and Insert Mode switches, or double-click the desired plug-in in the rack).
- 2 Click the Push-Pin icon in the upper-right of the screen (the icon is located just to the left of the Presets and View Toggle icons).
  - When enabled, the Push-Pin icon appears lit. This indicates that the current plug-in will remain on-screen and will not lose focus, even if another channel is targeted.
  - When not enabled, the Push-Pin icon appears unlit. Plug-in view follows control surface selections.



Push-Pin plug-in view icon

---

## Plug-In Presets and Snapshots

You can save and load plug-in Presets files to import, export, and transfer plug-in settings files.

Snapshots can also be used to automate changes to plug-in routing and settings.



*Presets can be applied to multiple Shows, while snapshots apply only to the Show file in which they are stored.*

## Presets

Presets are files that you can create to save, load, archive and transfer custom plug-in settings. You can then create your own Preset folders to organize Preset files. Preset folders and files can be transferred using the Filing Page.

### To create a custom Presets folder:

- 1 Go to the Filing page and click the Transfer tab.
- 2 Click the Preset Folders icon.
- 3 Click the New button at the left of the screen.
- 4 Do one of the following:
  - To leave the folder at its default name, press Enter.
  - or –
  - Type a new name and press Enter.

### To save a Preset:

- 1 Adjust the plug-in parameters as desired.
- 2 Click the Presets icon in the Plug-Ins screen.
- 3 In the Presets window, click New.
- 4 Enter a custom name for the Preset.

### To load a Preset into a plug-in:

- 1 Make sure the presets are already transferred and available on the current system. (Many plug-ins come with factory presets that will be installed along with the plug-in.)
- 2 Select the channel containing the plug-in, and target the desired plug-in (press the Insert Mode switch, or click the plug-in on-screen).
- 3 Click the Presets icon in the Plug-Ins screen.
- 4 Single-click a preset name in the Presets list to preview it. With the Presets list displayed, do any of the following:
  - To scroll through the list, press Up or Down arrow keys on your computer keyboard.
  - To load a preset and close the Presets list, double-click a name in the Presets list.
  - Click Cancel to close the Presets list without changing settings.

## Snapshots

Snapshots can automate plug-in settings, including routing, and in/out state. (Side-chain routing is not supported in Snapshots.)

Snapshots can also store and recall tempo, to synchronize delay and echo plug-ins that support Tempo Sync.



*Snapshots do not store or recall Presets. Snapshots store plug-in settings at the time the Snapshot is created or saved.*

Each rack slot in the Plug-Ins screen provides a Snapshot menu, with shortcuts for common snapshot-related tasks:

- Create a new snapshot
- Add one or more plug-ins to the MIDI/Plug-Ins list, and automatically re-scope the snapshot to include plug-ins.
- Remove plug-ins from one or more snapshots

**Snapshots Containing this Plug-In** Lists all currently loaded snapshots referencing the plug-in, in sequential order. Choose a snapshot to load it. (This menu option is useful for targeting snapshots while editing plug-in racks.)

**Create New Snapshot Containing this Plug-In** Adds a new snapshot to the snapshot list in which only plug-ins are scoped. This snapshot is inserted immediately after the currently targeted snapshot, which may not necessarily be the last snapshot. The snapshot is named to reflect the plug-in rack position, for example: “PI 1-1: Reverb One” is a Reverb One plug-in assigned to rack 1, slot 1.

**Add (or Update) this Plug-In to Snapshot** Adds a plug-in reference, with current settings, if the currently targeted snapshot does not already reference this plug-in. If the currently targeted snapshot already references this plug-in, the choice is Update (see next). If multiple snapshots are selected, this command changes to “Add Plug-In to Selected Snapshots” for batch-assignment.

**Update this Plug-In in Snapshots** Updates snapshots with current settings, if the currently targeted snapshot (or currently selected snapshots) already references this plug-in.

**Remove this Plug-In in Snapshot** Removes reference to this plug-in in the currently targeted snapshot, or from all currently selected snapshots.

 See Chapter 21, “Snapshots.”

## Plug-Ins and VENUE Standalone Software

You can use VENUE Standalone software to preconfigure plug-in routing and in/out state, with the following limitations:

- Plug-Ins cannot be installed in the Standalone Software.
- A Show file must be transferred from a console on which plug-ins were previously installed.

Once a Show file containing plug-ins has been transferred to the standalone software, the following rules apply:

- Plug-Ins can be placed in racks and routed in Standalone mode.
- Snapshots can be created, loaded, and stored.
- Plug-In settings cannot be adjusted.
- Plug-In Presets cannot be saved or loaded.

---

## Plug-In DSP Usage

Plug-Ins utilize DSP resources when they are assigned to a rack slot, and that rack slot is powered on. You can turn off unused plug-ins to reclaim their DSP by making them inactive, or by removing them from the system.

Plug-In availability is limited to the available DSP resources.

The amount of DSP available for plug-ins also varies with the current system configuration settings for Input Channels, FX Returns, and graphic EQs. Higher number of Input Channels leave fewer DSP resources for plug-ins, as shown in the Options > System Config screen.

## Initializing the Plug-In Racks

The racks are initialized (or re-initialized) whenever the system is first powered on, whenever the FOH Rack is restarted, after installing a plug-in, and after disabling or re-enabling a plug-in.

While the racks are initializing, they are offline and do not process audio. Avoid performing any Filing or Transfer functions until the racks are finished initializing. Rack status is displayed on-screen in the banner display.

---

## Plug-In Levels

VENUE systems display levels in meters in dBVU, with 0 dBVU = +4dBu analog out = -20dBFS.

Internally, VENUE systems provide up to 48-bit processing for built-in EQ and dynamics. Plug-Ins provide up to 24-bit processing, with level matching circuitry and logic ensuring maximum fidelity and sonic performance throughout the entire signal path. Due to variances in how plug-in metering is implemented by different manufacturers, performance may vary with regard to plug-in gain reduction meters and their relative levels.

When using side-chain routing, be aware of potential level differences between Input Channel pickoff points. For more information, see “Side-Chain Keys and Filters” on page 139.

---

## Plug-In Latency and Processing Delay

Plug-In latency includes processing delay of the plug-in itself plus routing delay, as follows:

- Instance delay: 2 samples per plug-in
- DSP routing delay: 3 samples

### Viewing Plug-In Latency

Cumulative channel processing delay can be viewed by right-clicking the Inserts area of the selected channel. The cumulative delay includes latency reported by all inserted plug-ins, signal routing and the known hardware insert delay, if applicable.

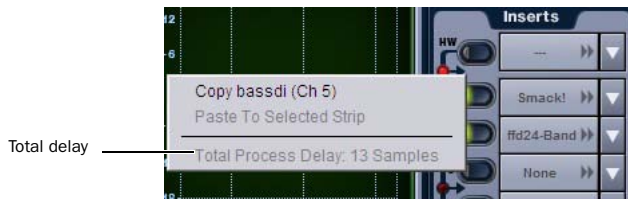

#### Viewing cumulative delay by right-clicking the Inserts section

Individual plug-In processing delay can be seen by right-clicking the plug-in icon in the rack. Use the number reported when calculating latency for manual delay compensation.

### Examples

If there is only one plug-in on a channel, the total delay will be the amount of plug-in latency + 2 + 3. (2 samples for the one plug-in instance, plus 3 samples for the DSP routing to the racks and back.)

If you have two plug-ins on a channel or bus, the delay will be plug-in #1 latency + 2 + plug-in #2 latency + 2 + 3. If plug-in #1 has 12 samples of latency, and plug-in #2 has 15, total latency will be 34 samples (12 + 2 + 15 + 2 + 3).

# Chapter 19: Hardware Inserts

Mix Rack and FOH Racks let you route signals to and from external devices as hardware inserts. Hardware inserts can be used on input channels, FX returns, Groups, Auxes, Matrixes, Personal Qs, and Mains.

Mix Rack and FOH Rack provide 8 analog hardware insert channels. Up to 16 analog and 8 digital hardware inserts can be used with an FOH Rack (requires an I/Ox expansion option).

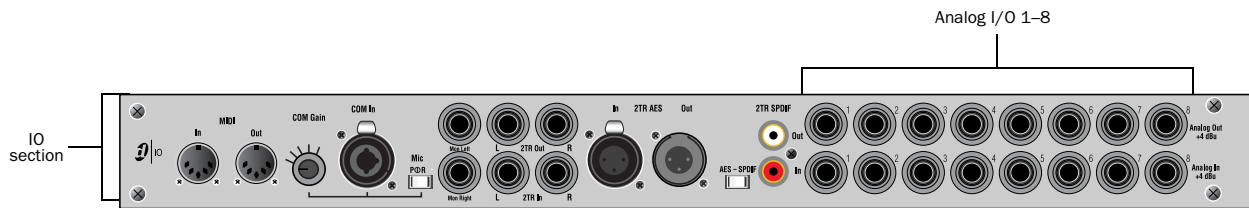

Figure 16. Hardware insert patch points on Mix Rack and FOH Rack, showing standard mix position (FOH) I/O connectors

## Connecting External Effects Units

Outboard gear is made available to the system by connecting its inputs and outputs to connectors in the FOH I/O sections of the Mix Rack or FOH Rack. Hardware inserts can then be assigned on channels similarly to inserting plug-ins.

### To connect outboard gear for use as a hardware insert:

- 1 Connect the external device inputs to analog or digital Out connectors (Analog 1–8, Analog 9–16, or AES 1–8) on the Mix Rack or FOH Rack.
- 2 Connect the external device outputs to the corresponding In connectors on the back panel of the Mix Rack or FOH Rack. For example, signal taken from FOH Output 1 returns on FOH Input 1.

## Assigning Hardware Inserts to Channels

You can assign hardware inserts directly from the Inputs page or Outputs page. You can also make hardware insert assignments from the Patchbay.

For complete instructions, see Chapter 12, “Patchbay.”

### To assign a hardware insert to a channel or bus:

- 1 Go to the Inputs or the Outputs page and target the channel where you want to assign the hardware insert by pressing the channel Select switch.

- 2 In the Inserts section, do one of the following:

- Click the Hardware Insert pop-up menu and choose an insert destination directly from the menu. The name of the hardware insert destination appears in the on-screen Hardware Insert button.
- or –
- Click the Hardware Insert button to go to the Inserts page of the Patchbay, and assign the insert from the Patchbay.

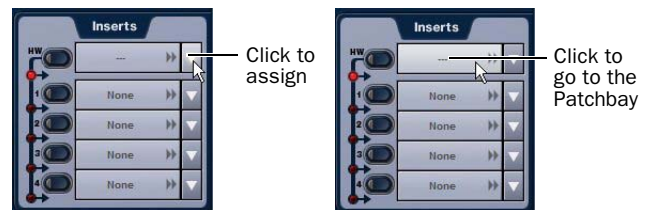

Assigning a hardware insert in the Outputs page

### To assign a hardware insert from the Patchbay:

- 1 Go to the Patchbay and click the Inserts tab. The Hardware Tab for the Mix Rack or FOH Rack is shown.
- 2 Click the Channels, FX Returns, or Outputs tabs to show the desired channel types in the grid. If you jumped to the patchbay from the Inputs or Outputs page, the appropriate Channel Type tabs are automatically enabled.

3 Click in the channel grid to assign the insert input/output number (listed across the top) to the channel where you want to assign the insert (listed on the left).



Assigning a hardware insert in the Patchbay Inserts page

The Patchbay Inserts tab shows the name of the channel and its destination at the current cursor location. The Insert location is also displayed in the Inserts section in the Inputs or Outputs page.

### Setting the Hardware Insert Location

You can choose the location of the hardware insert in the signal path relative to the four plug-in inserts, for each channel.

**To set the hardware insert location:**

- 1 Go to the Outputs page and select the channel where you want to set the hardware insert location.
- 2 In the Inserts section of the Outputs page, click the hardware insert indicator so that it lights red.

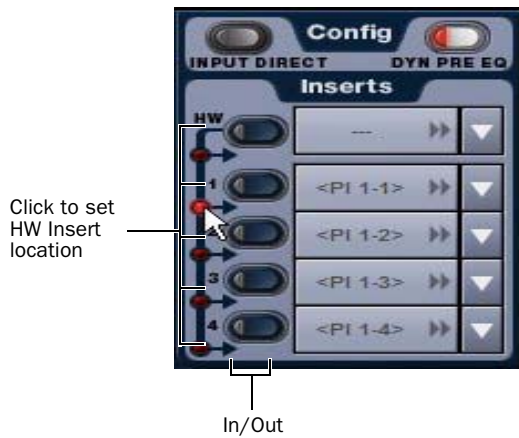

Setting a hardware insert location in the Inputs page

### Activating and Bypassing Hardware Inserts

The controls for activating and bypassing hardware inserts are available on-screen in the Inserts sections of the Inputs and Outputs pages.

**To activate or bypass a hardware insert:**

- 1 Target the channel where you want to activate or bypass the insert by pressing the channel Select switch.
- 2 Click the In/Out button for the HW insert. The button lights when the insert is activated (in circuit).

## **Part V: Shows**





# Chapter 20: Shows and File Management

Data can be stored, recalled and transferred between VENUE systems. There are three types of information files that can be managed separately, as follows:

**Show Files** These files are used to store, recall and transfer system settings, snapshot, and events.

**Preset Files** These files are used to store settings for channel strips, built-in processors and plug-ins, and Recall Safe Scope Sets.

**Console Setting Files** These files are used to transfer or back up the current state of the VENUE system.

**!** *The system does not need to be in Config mode to carry out file management tasks. However, many file management operations, including loading Shows, may interrupt audio throughput. Make sure to perform all file management tasks before a performance.*

## Creating Shows

A Show file contains all configuration, signal routing, mixer settings, plug-in information, snapshots, and other operational settings. Shows are grouped together in Show Folders.

## Show Folders

Show Folders contain Show files. You can create and manage Show Folders from the Save tab of the Filing page.

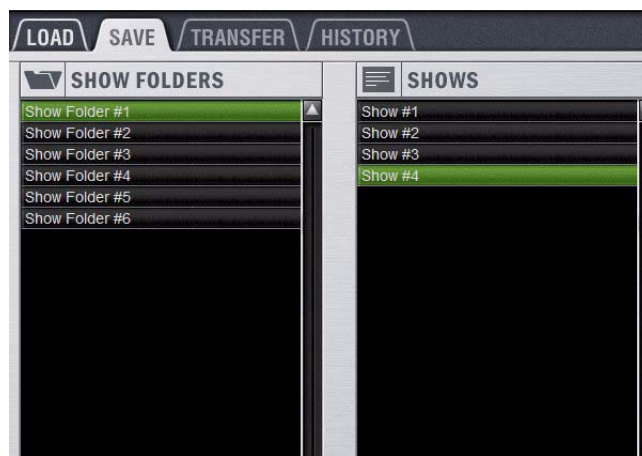

Show Folders and Show files in the Save tab of the Filing page

## Creating Show Folders

**To create a new Show Folder:**

- 1 Go to the Filing page and click the Save tab.
- 2 In the Show Folders column, click the New button.
- 3 Type a name for the Show Folder and press Enter.

## Duplicating Show Folders

**To duplicate a Show Folders:**

- 1 In the Show Folders column, click a Show Folder name to select the folder.
- 2 Click the Duplicate button.

The folder and all of the Show files it contains are duplicated.

**!** *You can also duplicate folders by right-clicking a Show Folder name and choosing Duplicate.*

## Renaming Show Folders

**To rename a Show Folder:**

- 1 In the Show Folders column, click a Show Folder name to select the folder.
- 2 Click the Rename button.

**!** *You can also rename Show Folders by right-clicking a Show Folder name and choosing Rename, or by double-clicking a Show Folder name.*

- 3 Type a new name for the Show Folder and press Enter.

## Deleting Show Folders

When you delete a Show Folder, all Show files contained in that folder are also deleted.

**To delete a Show Folder:**

- 1 In the Show Folders column, click a Show Folder name to select the folder.
- 2 Click the Delete button.

**!** *You can also right-click a Show Folder name and choose Delete to delete the folder.*

## Show Files

### Creating and Saving Show Files

When you create a new Show file, it captures the current state of the system. Show files are automatically saved when they are created or overwritten.

#### To create a new Show file:

- 1 Go to the Filing page and click the Save tab.
- 2 In the Show Folders column, select the Show folder where you want to save the Show.
- 3 In the Shows column, click the New button. The new Show file captures the current state of the system.
- 4 Type a name for the Show file and press Enter.
- 5 Double-click in the Notes field for the Show and type any comments you want to save with the Show.

Information about the Show file is shown in the Info area of the Filing page.

 *Show files are automatically saved when they are created; no further action is required to save them.*

#### To update or overwrite an existing Show file:

- In the Shows column, right-click the Show file name you want to overwrite, and choose Overwrite from the pop-up menu. The current state of the system is saved to the selected Show file.



Right-clicking a Show file name in the Shows column

### Duplicating Show Files

#### To duplicate a Show file:

- 1 In the Shows column, click a Show file name to select it.
- 2 In the Shows column, click the Duplicate button.

 *You can also right-click a Show file name and choose Duplicate to duplicate the file.*

### Renaming Show Files

#### To rename a Show file:

- 1 In the Shows column, click a Show file name to select it.
- 2 In the Shows column, click the Rename button.

 *You can also right-click a Show file name and choose Rename, or double-click the Show file name to rename the file.*

- 3 Type a new name for the Show file and press Enter.

### Deleting Show Files

#### To delete a Show file:

- 1 In the Shows column, click a Show file name to select it.
- 2 In the Shows column, click the Delete button.

 *You can also right-click a Show file name and choose Delete to delete the file.*

---

## Loading Shows

You can load Show files using the Load tab of the Filing page.

Shows cannot be loaded onto the destination VENUE system directly from a portable storage device; they must first be transferred to the system before loading.

 *Loading a show automatically replaces the current console settings with those of the loaded show, and may interrupt audio throughput.*

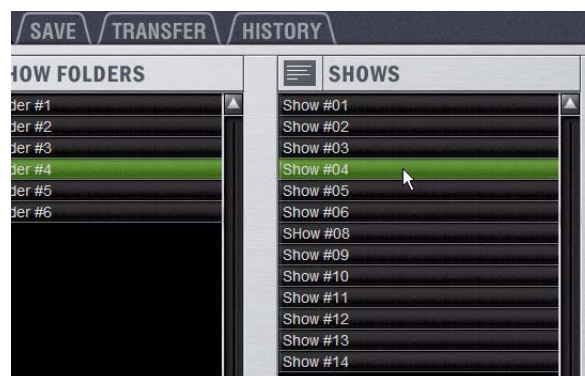

Show Folders and Show files in the Load tab of the Filing Page

#### To load a Show file:

- 1 Go to the Filing page and click the Load tab.
- 2 In the Show Folders column, click a Show Folder name to select the folder. Any Show files in the folder are displayed in the Shows column.
- 3 In the Shows column, click a Show file name to select it.
- 4 Click the Load button.

The system loads the new Show file, replacing the current system configuration, routing, and control settings with those contained in the new file.

## System Configurations and Loading Shows

Show files include VENUE system configuration settings (such as the type of console (VENUE Profile or VENUE D-Show Main and Sidecars); the number of Mix Engines; Number of Input Channels, FX Returns, and EQs; Aux and Group Bus configurations), and plug-in status.

- If a Show file includes the same system configuration settings as the current configuration, the configuration information appears in blue text in the Info area.
- If a Show file differs from the current configuration, but can be loaded on the system, the relevant configuration changes appear in orange text in the Info area. When the Show file is loaded, the system restarts in the new configuration.
- If a Show file differs from the current configuration and cannot be loaded on the system in its entirety, the configuration information appears in red text in the Info area.
- Plug-in status is reviewed:
- Plug-ins that have been removed (uninstalled) no longer appear in menus and lists.
- Plug-in versions are checked for compatibility with the current system.

 For more information on plug-in management, see “Managing Plug-Ins on the System” on page 153.

If a Show configuration is too large for the current system, mix elements are dropped in the following order:

- 1 Plug-Ins are deactivated
- 2 Graphics EQs are dropped
- 3 Input Channels are dropped

## Working with Presets

Preset files are used to store, recall and transfer factory or user-defined presets. Preset files are grouped in the following types of Preset Folders:

**Built-in** 4-band EQ, 31-band Graphic EQ, Compressor/Limiter, Expander/Gate, and Input Channel Presets

**Plug-In** Plug-ins Settings Files

**Scope Sets** Settings for Recall Safe configurations

## Preset Folders

Preset Folders contain Preset files. Each of the built-in processors (Compressor/Limiter, Expander/Gate, 4-band EQ, 31-band Graphic EQ) and each plug-in has its own Factory Defaults folder. Additional folders are provided for Scope Sets.

You can create additional Preset Folders for each processor or plug-in and store new Presets in them. These folders can then be transferred to a portable storage device for transfer to other VENUE systems.

 For information on saving, previewing and loading built-in dynamics and EQ presets, see Chapter 16, “Dynamics” and Chapter 17, “EQ.”

For plug-in settings, see Chapter 18, “Plug-Ins.” For Scope Sets, see Chapter 21, “Snapshots.”

For Input Channel Presets, see Chapter 5, “Navigating and Selecting Channels”,

## Creating Preset Folders

**To create a new Preset Folder:**

- 1 Go to the Filing page and click the Transfer tab.
- 2 Click the Preset Folders icon. A list of Preset Folders appears in the left column.



*Preset Folders icon in the Transfer tab of the Filing page*

- 3 In the left column, click the New button.
- 4 Type a name for the Preset Folder and press Enter.

The new Preset Folder is available in the Preset window for each processor or plug-in.

## Duplicating Preset Folders

### To duplicate a Preset Folder:

- 1 In the left column, click a Preset Folder name to select it.
- 2 Click the Duplicate button.

The folder and all of the Preset files it contains are duplicated.

 You can also right-click a Preset Folder name and choose *Duplicate* to duplicate the folder.

## Renaming Preset Folders

### To rename a Preset Folder:

- 1 In the left column, click a Preset Folder name to select it.
- 2 Click the Rename button.

 You can also right-click a Preset Folder name and choose *Rename*, or double-click a Preset Folder name to rename the folder.

- 3 Type a new name for the Preset Folder and press Enter.

## Deleting Preset Folders

When you delete a Preset Folder, all Presets contained in that folder are also deleted.

### To delete a Preset Folder:

- 1 In the left column, click a Preset Folder name to select it.
- 2 Click the Delete button.

 You can also right-click a Preset Folder name and choose *Delete* to delete the folder.

## Preset Files

You can manage Preset files from the Transfer tab of the Filing page. You cannot create Preset files from the Filing page. Preset files are created from the Presets window of the channel, processor or plug-in; Scope Sets are created from the Scope Sets window of the Recall Safe page.

## Duplicating Presets

### To duplicate a Preset file:

- 1 Go to the Filing page and click the Transfer tab.

- 2 Click the Built-In or Plug-In icon and choose a processor or plug-in from the pop-up menu. The available Preset Folders for the processor or plug-in appear in a pop-up menu above the left column.

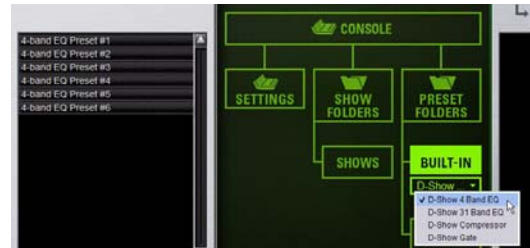

Built-In EQ in the Transfer tab of the Filing Page

- 3 Click the Preset Folder name and choose a Preset Folder from the pop-up menu. Any Presets in the folder appear in the left column.



Preset Folder names at the top of the Presets column

- 4 Click a Preset file name to select the file.
- 5 Click the Duplicate button.

 You can also right-click a Preset file name and choose *Duplicate* to duplicate the Preset.

## Renaming Presets

### To rename a Preset file:

- 1 In the left column, click a Preset file name to select the file.
- 2 Click the Rename button.

 You can also right-click a Preset file name and choose *Rename*, or double-click a Preset file name to rename the Preset.

- 3 Type a new name for the Preset file and press Enter.

## Deleting Presets

### To delete a Preset file:

- 1 In the left column, click a Preset file name to select it.
- 2 Click the Delete button.

 You can also right-click a Preset file name and choose *Delete* to delete the Preset.

## Transferring Settings, Shows and Presets

You can copy Console Settings, Shows, and Presets to and from a portable storage device (such as a USB key disk) for backup, transfer from standalone software, and transfer between systems.

 *Console Settings are equivalent to an auto-saved Show file, and store the current state of the console. By transferring Console Settings, you can transfer the current state of the console without having to first create and name a Show file.*

Settings, Shows and Presets cannot be loaded onto the destination system directly from the portable storage device, but must first be transferred to the system before loading.

Transfer of Settings files, Show files, and Preset files is managed from the Transfer tab of the Filing page. The Transfer tab shows the system-resident files in the left column and the contents of the portable storage device in the right column. Items are selected for transfer in the center.



File transfer controls

**To transfer Settings, Shows or Presets to or from a portable storage device:**

- 1 Go to the Filing page and click the Transfer tab.
- 2 Connect a portable storage device (such as a USB key disk) to the system. The device appears above the right column.
- 3 Do one of the following to select the type of data to transfer:
  - To transfer all data, click the Console icon.
  - To transfer Console Settings, click the Settings icon.
  - To transfer Show Folders, click the Show Folders icon.
  - To transfer individual Shows, click the Shows icon.
  - To transfer Preset Folders, click the Preset Folders icon.
  - To transfer Presets for individual items, click the Built-In or Plug-In icon and choose a built-in processor or plug-in, or Input Channel from the pop-up menu.
  - To transfer Scope Sets for Recall Safe, click the Scope Sets icon.



Preparing to transfer items to USB key disk

- 4 Do one of the following to select the items to transfer:
  - In the left column, select the items you want to transfer to the portable storage device.
  - or –
  - In the right column, select the items you want to transfer from the portable storage device to the VENUE system.
- 5 Click the Transfer button.

Large transfers may take time. Transfer status is shown by a progress bar. A transfer may be cancelled by clicking Cancel.

 *Cancelled transfers may result in partial folder contents, which will have to be deleted manually.*

## Synchronizing Settings, Shows and Presets

Instead of transferring data in one direction between the VENUE system and a portable storage device, you can synchronize all data in both columns of the Transfer tab in a single operation.

Synchronizing data causes new files to be copied and files with the same name but a more recent modification date/time to be automatically updated.

 *When synchronizing data, the VENUE software replaces data files of the same name with the file that has the most recent date/time. Check to be sure that the system clock times and time zones are correctly set on the system and on the computer running the Standalone software when preparing data for synchronization.*



## To synchronize Settings, Shows, or Presets between the VENUE system and a portable storage device:

- 1 Go to the Filing page and click the Transfer tab.
- 2 Connect a portable storage device such as a USB key disk. The device appears above the right column.
- 3 Do one of the following to select the type of data to synchronize:
  - To synchronize all data, click the Console icon.
  - To synchronize Console Settings, click the Settings icon.
  - To synchronize Show Folders, click the Show Folders icon.
  - To synchronize individual Shows, click the Show icon.
  - To synchronize Preset Folders, click the Preset Folders icon.
  - To synchronize Presets for individual items, click the Built-In icon or the Plug-In icon and choose a processor or plug-in from the pop-up menu.
- 4 From the pop-up menus above each column, choose the folders containing the elements you want to synchronize.
- 5 Click the Sync All button. The contents of the left and right columns are synchronized.

 *Using the Standalone software on a laptop computer, you can configure VENUE system routing, set up mixes, create Snapshots, and save Shows and Presets. You can then transfer your data to a USB disk for use on a VENUE system. See Chapter 24, "Using the Standalone Software."*

## Undoing Changes Using the History Feature

The VENUE system automatically saves the current state of the console while you are working, allowing you to quickly return the console to a previous state.

The History feature uses Show files to capture the console state, and displays the files in the History tab.

 *Show Folders and Show files displayed in the History tab can only be deleted. They cannot be duplicated or renamed.*

### Show Folders in the History Tab

There are two Show Folders in the History tab:

- ◆ The *Most Recent Changes* folder includes all auto-saved Show files for a ten-hour period.
- ◆ The *Previous Days* folder includes only the last auto-saved Show file for each day since the console was last cleared.

### Show Files in the History Tab

The auto-saved Show files displayed in the History Tab are named according to the date and time of their creation, and cannot be renamed.

The Notes field for each auto-saved Show file includes a description of the conditions that caused the automatic save.

Several conditions cause the system to automatically save a new Show file in the History tab, as follows:

- ◆ In the course of normal work, a new Show file is automatically saved in the History tab approximately every ten minutes. Saves are less frequent when the console is idle.
- ◆ A new Show file is automatically saved just prior to a significant change in the console setup, including:
  - Change of console channel or bus configuration
  - Recall, storage, or modification of a Snapshot
  - Loading of Console Settings or a Show

## Loading an Auto-Saved Show

To return the console to an earlier state at any time, you can load any of the auto-saved Show files displayed in the History tab.

### To load an auto-saved Show file:

- 1 Go to the Filing page and click the History tab.
- 2 In the Show Folders column, click the Show Folder name to select the folder and display its contents in the Shows column.
- 3 In the Shows column, click the name for the Show you want load.

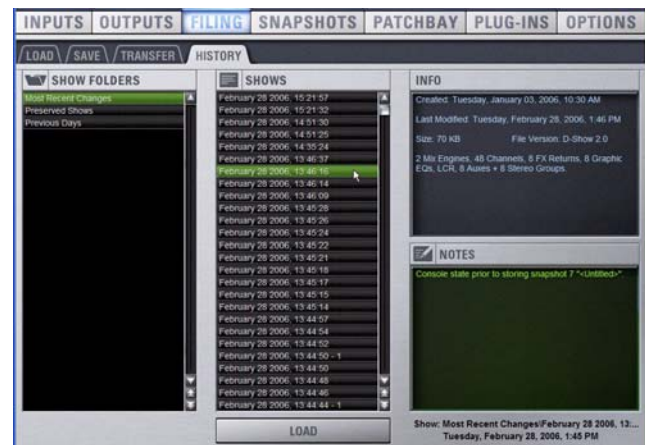

Loading an auto-saved Show file

- 4 Click the Load button.

The VENUE system loads the selected Show file, replacing the current system configuration, routing, and control settings with those contained in the selected file.



# Chapter 21: Snapshots

Snapshots let you flexibly store and recall a wide range of mixing parameters. Snapshots are commonly used to store the mixer setup and levels for individual scenes, songs or sound cues in a performance. Snapshots store information about channels and mix parameters, and can also include MTC, tempo, and crossfade instructions.

Snapshots are contained and stored as part of a Show. A single Show file can contain up to 999 snapshots. Snapshots are controlled from the on-screen Snapshots page, or from the Snapshot controls on the console. Once stored, snapshots can be recalled manually or automatically (triggered by events or MTC). Snapshots can also trigger events. The system also provides a variety of methods to edit, preview, and manage snapshot data.

## Snapshots Page

The Snapshots page provides controls for storing, recalling, and managing snapshots, providing a central location for setting up and replaying automated performances.

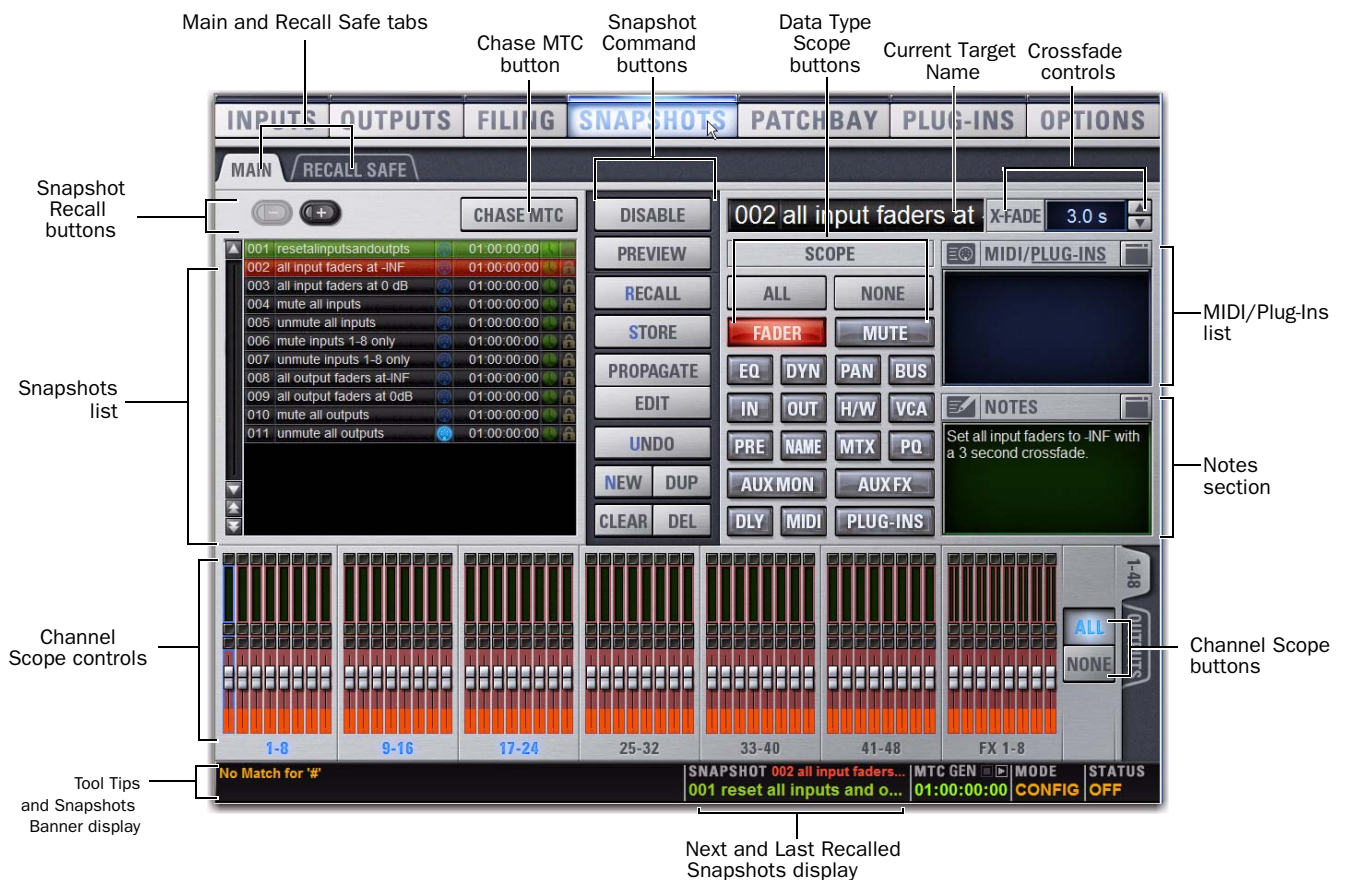

Figure 17. Sections of the Snapshots page

To display the Snapshots page, do one of the following:

- Click the Snapshots tab on-screen.
  - or –
- Press the Snapshots switch in the View Modes section.

 Repeatedly pressing the Snapshots View Mode button toggles between the Main and Recall Safe tabs.

## Main and Recall Safe

The Snapshots screen provides the Main and Recall Safe tabs.

**Main** Provides the primary snapshot controls.

**Recall Safe** Provides a matrix of channel parameters that can be globally safed (or isolated) from Recall for all snapshots.

## Snapshots List

Snapshots can be targeted, renamed, recalled, previewed, edited, locked, reordered, duplicated, searched, and deleted from the Snapshots list.

## Snapshot Command Buttons

**Disable** Temporarily disables all snapshot functions.

**Preview** An “offline” mode in which the console continues to process audio using its settings at the time Preview is invoked, letting you recall, edit and manage snapshots without affecting the current mix.

**Recall** Recalls the targeted snapshot, updating the console to reflect the status of all scoped data types and channels in the snapshot (subject to the current Recall Safe settings).

**Store** Stores the current state of the console in the targeted snapshot for all data types and channels, overwriting any existing data in the snapshot.

**Propagate** Enables Propagate mode. Lets you apply isolated changes to one or more snapshots at once (such as updating a channel EQ across all snapshots).

**Edit** Enables Edit mode. Lets you adjust parameters freely and apply those changes to one or more snapshots. Changes can be applied in Absolute or Relative fashion.

**Undo** Returns the console to its state before the last snapshot command.

**New** Creates a new snapshot that captures the current state of all data types and channels.

**Duplicate** Creates a copy of the selected snapshots.

**Clear** Clears the contents of the targeted snapshot, but retains any associated MTC information.

**Delete** Deletes the targeted snapshots.

## Snapshot Scope Controls

The selection of data types and channels to be recalled is referred to as the *scope* of a snapshot. The scope of data to be recalled is also stored within each snapshot.

The Snapshot Data Type buttons and on-screen Channels determine (and display) which data types are recalled for which channels on the console.

The Recall Safe tab provides global control of automation safe status for parameters on individual channels.

## Scope States

**Scoped** Red display indicates that the data type or channel is currently scoped and will be affected by snapshot recall.

**Not Scoped** Gray display indicates that the data type or channel is not currently scoped and will not be affected by snapshot recall.

## Data Type Scope Buttons

The Snapshot Data Type buttons display scope status for the corresponding types of controls on the console. See Table 22 on page 201 for a complete list.



Data Type Scope buttons showing different scope states

## Channel Scope Controls

Channels are included or excluded from snapshots by clicking them on-screen in the Snapshot Channel Faders display. The Snapshot faders display the scope status of each channel on the console, along with indication of the fader positions and mute states that will result by recalling the targeted snapshot.

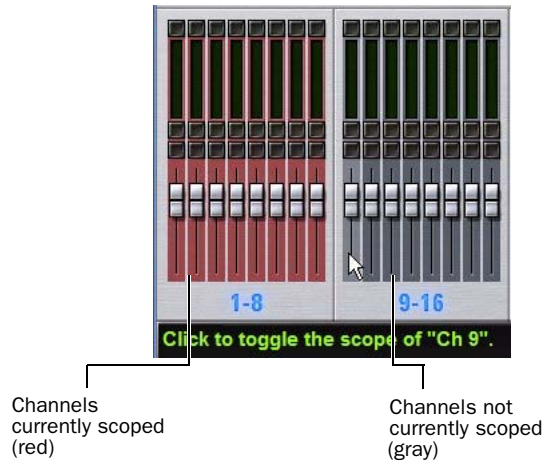

Snapshot channel fader display showing different scope states

### Channel Fader Position

When you target a snapshot with scoped channels that have different fader positions from the current fader positions, the target fader positions are shown in bright red.



Snapshot channel fader display showing target fader positions

### Channel Mute State

When you target a snapshot with scoped channels that have different mute states from the current mute states, the target mute buttons are outlined in yellow.

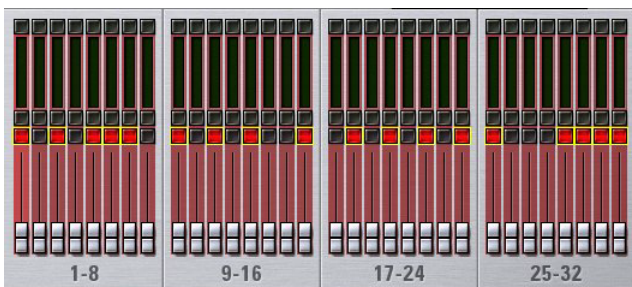

Snapshot channel fader display showing target mute states

## Selected Channel Indication

The Snapshots page *indicates* the currently selected channel.

- ◆ If the selected channel is not scoped in the currently selected snapshot, it is indicated with a blue highlight.
- ◆ If the currently selected channel is scoped in the currently selected snapshot, it is indicated by a blue outline around the on-screen fader strip.

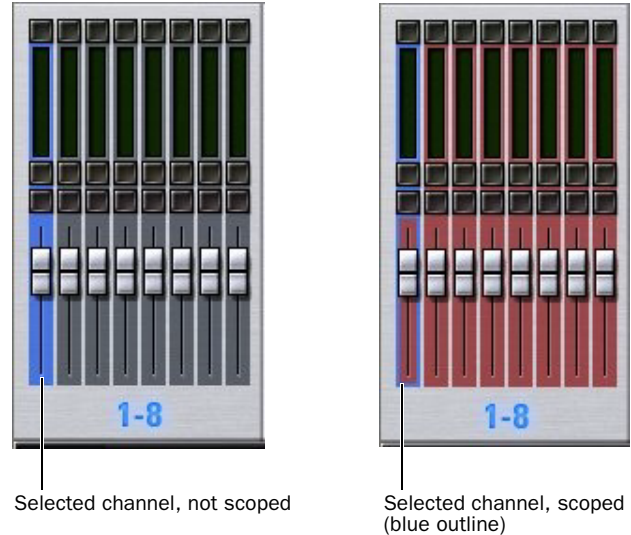

Selected channel indication in the Snapshots page

💡 *Though the currently selected channel is displayed in the Snapshots page, keep in mind that you cannot target a different channel from this page. The currently selected (target) channel is indicated for visual reference only. To select and target a different channel, use the channel Select switches or the Channel Scroll buttons.*

## Data Type Scope Action Buttons

**All** Turns on the scope for all data types at once. This is equivalent to clicking all of the Data Type buttons so they are red.

**None** Turns off the scope for all data types at once. This is equivalent to clicking all of the Data Type buttons so they are gray.

## Channel Scope Action Buttons

**All** Turns on the scope for all channels displayed on the current tab (such as 1–48). Double-clicking the All button turns on the scope for all channels on the system.

**None** Clicking the None button turns off the scope for all channels on the current tab. Double-clicking the None button turns off the scope for all channels on the system.

## Next Snapshot Indication in Status Display

The Snapshot Status display shows the currently targeted (next) snapshot in red text directly above the display of the last (most recently recalled) snapshot. Pressing the Snapshot Recall button immediately recalls the targeted snapshot and makes it the last recalled snapshot.



Next and Last Recalled snapshot display in the Status area

## Snapshot Controls on the Console

Snapshot controls are provided in the Snapshots section. These controls provide direct access to a few basic snapshot commands and allow manual control of snapshot recall.

### Snapshots Section

You can target (select), store, and recall snapshots from the Snapshots controls in this section.

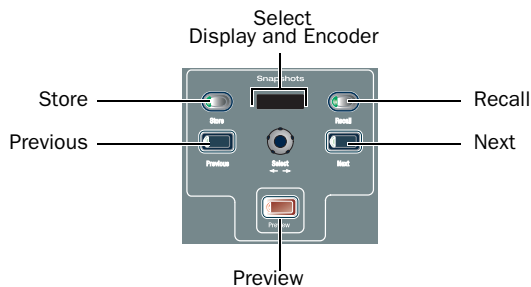

Snapshots section on the console

The Snapshot controls in the Snapshots section perform the following functions:

**Store** Stores the current state of all console parameters in the targeted snapshot. This switch mirrors the Store button in the Snapshots page.

**Recall** Recalls the targeted snapshot. This switch mirrors the Recall button in the Snapshots page.

**Select Display and Encoder** Turning the Select encoder scrolls through and selects the targeted snapshot in the Snapshots list. The 6-character display shows the name of the currently targeted snapshot. A period is appended to the displayed snapshot name to indicate whenever it has been edited since being recalled.

**Previous** Instantly recalls the snapshot prior to the most recently recalled snapshot. This switch mirrors the Recall Previous button in the Snapshots page.

**Next** Instantly recalls the snapshot immediately following the most recently recalled snapshot. This switch mirrors the Recall Next button in the Snapshots page.

**⚠** *The Previous and Next switches combine target and recall actions in one step, causing the next or previous snapshot to be instantly active. These switches cannot be used to preview snapshots before recalling them.*

### F1 for Preview Mode

When the Mute Groups/Function section is in Function mode, pressing F1 engages Preview mode (see “Preview Mode” on page 191).

**💡** *For more information on how to use the Event List to customize this or other console functions, see Chapter 22, “Events.”*

## Snapshots List



Snapshots list

### Snapshot Entries

Each entry in the Snapshots List has a number (001–999) and name. To the right of each number and name are icons for the currently displayed snapshot attributes. The Snapshot List lets you configure, display and control the following attributes for each snapshot:

- If either the MIDI Read or Generate feature is enabled, each snapshot will also have a time code value, trigger indicator, or send indicator. (See “Adding MIDI Messages to Snapshots” on page 195.)
- If the System Tempo has been enabled in Options > Misc, Tempo can be stored for each snapshot instead of MIDI (both MIDI and Tempo are available parameters at all times; the only limitation is that the Snapshots List can only display one or the other at a time). When the Snapshot List is configured to show Tempo, each list item will show the tempo value associated with each tempo, along with a Tempo On/Off toggle icon. (See “Adding Tempo Data to Snapshots” on page 196.)



- If the system includes a Pro Tools record/playback option, snapshots can be configured to create a Marker in the Pro Tools recording whenever that snapshot is recalled. (See “Pro Tools Markers and Snapshots” on page 196.)
- Each snapshot provides a Lock icon that toggles the snapshot between Locked (write-protected) and Unlocked. See “Locking Snapshots” on page 188.

## Recall Buttons

The Recall Previous (–) and Recall Next (+) buttons at the top of the Snapshots List cause the previous or next snapshot to be targeted and recalled in one step.

## Chase MTC

Enables or suspends automated recall of snapshots when either the MTC Read or MTC Generate option is enabled.

## Navigating the Snapshots List

Snapshots are highlighted in color in the Snapshots list to indicate the following:

**Green** Indicates the last recalled snapshot

**Red** Indicates the currently targeted snapshot

**Yellow** Indicates that the snapshot is both the last recalled and currently targeted snapshot

**Blue** Indicates that the snapshot is part of a multiple snapshot selection but not the last recalled or currently targeted snapshot. Recalled and Targeted snapshots can also be part of a multiple selection in the list. In this case, the sequence number is blue while the rest of the name is red, green or yellow.

## Snapshot Keyboard Shortcuts

When the Snapshots page is displayed, you can perform the following Snapshot functions with these keyboard shortcuts:

Snapshot Function	Keyboard Shortcut
Target Next/Previous Snapshot	Up/Down Arrow keys
Target First Snapshot in List	Home key
Target Last Snapshot in List	End key
Target Snapshot at Top of Page	Page Up
Target Snapshot at Bottom of Page	Page Down
Select Multiple Contiguous Snapshots	Shift-click snapshots
Select Multiple Non-Contiguous Snapshots/Deselect any Snapshot	Ctrl-click snapshots
Select All Snapshots	Ctrl+A
Create New Snapshot	Ctrl+N

Snapshot Function	Keyboard Shortcut
Recall Targeted Snapshot	Ctrl+R
Store Targeted Snapshot	Ctrl+S
Undo	Ctrl+U
Add or update MIDI/Plug-in data to snapshot	Right-click MIDI/Plug-ins entry

## Selecting Snapshots

You can select single snapshots or multiple snapshots in order to target, recall, duplicate, edit, lock or delete them in the snapshots list.

### To select multiple contiguous snapshots:

- Shift-click the snapshot names in the Snapshots list.

### To clear a selection of multiple contiguous snapshots:

- Click any snapshot name in the Snapshots list.
  - or –
- Turn the Select knob in the Snapshots section.

### To select or de-select non-contiguous snapshots:

- Ctrl-click the snapshot names in the Snapshots list.



Multiple items selected in the Snapshots list

## Snapshot Type Text Search

Type Text search lets you use the keyboard for fast navigation of the Snapshots List.

### To search for and target a snapshot:

- 1 Go to the Snapshots page.
- 2 Do one of the following:
  - Type the number of the snapshot.
    - or –
  - Type the first letters of the snapshot name.
- 3 Press the Tab key to cycle through any snapshots that start with the same letter.

## Centering the Snapshot List

The Options > Snapshots page provides a preference setting to always center the Snapshot list on the last recalled snapshot. This setting lets you always view the snapshots immediately above and below (prior to and following) the last recalled snapshot. This setting only affects the scroll position of items in the Snapshot list.



Snapshot list with Center Last Recalled Snapshot enabled

### To center the Snapshot List on the last recalled snapshot:

- 1 Go to the Options > Snapshots page.
- 2 In the Snapshots General Preferences section, click to select the Center Last Recalled Snapshot setting.

## Creating Snapshots

Snapshots can be created at any time to store the current channel and parameter settings. You can create new snapshots manually in the Snapshots page (see “Creating New Snapshots” on page 182), or by duplicating existing snapshots to build your mix as you work.

 Use the first snapshot in a Show file to establish the basic settings for a performance. For subsequent snapshots, use the scope controls and Recall Safe settings to selectively recall only those controls that need to change between sections or songs, leaving other controls unaffected by snapshot recall.

## Creating New Snapshots

When you create a snapshot, it captures the current state of all console settings.

### To create a new snapshot:

- 1 Set all parameters on the console whose state you want to store in the snapshot.
- 2 Click New. The new snapshot appears in the Snapshots List.
- 3 For each channel you want affected when the snapshot is later recalled, click the channel so that it is scoped (displayed in red).



Adding channels to the scope of a snapshot

 To quickly select (or de-select) banks of channels, click their blue labels below the Channel Faders in the Snapshots page.

4 For each parameter of the scoped channels you want affected when the snapshot is later recalled, click the corresponding Data Type button so that it is scoped (displayed in red).



Plug-ins included in the scope of a snapshot

 When you create a new snapshot it automatically inherits the channel and data type scope of the currently targeted snapshot.

 The New command can be undone.

## Naming Snapshots

New snapshots are automatically numbered and appear as “<Untitled>” in the Snapshots list. Snapshots can be renamed at any time. You can undo snapshot naming operations.

### To name a snapshot:

- 1 Do one of the following:
  - Double-click the snapshot name in the Snapshots list or the current target name display.
  - or –
  - Right-click the snapshot name and choose Rename.
- 2 Type a name for the snapshot.
- 3 Press Enter on the keyboard or click another snapshot name.

## Adding Notes to Snapshots

You can add notes to snapshots at any time. You do not need to store the snapshot to save the notes in the snapshot.

### To add or edit comments for a snapshot:

- 1 Double-click the Notes header or click the list icon to expand the Notes field.
- 2 Double-click in the Notes field and enter text.

## Recalling Snapshots

### Targeting Snapshots

Targeting a snapshot lets you preview which data types and channels will be affected by that snapshot before recalling it. When a snapshot is targeted, the on-screen Data Type buttons and Channel Faders update to show the data types and channels enabled for recall by the snapshot.

 Preview mode lets you take the console offline to recall and edit snapshots in their entirety without affecting the current mix. See “Preview Mode” on page 191.

### To target a snapshot, do any of the following:

- Click the snapshot name in the Snapshot list.
- Type the number or name of the snapshot on the keyboard.
- Press the Home/End, Page Up/Page Down, and Up/Down Arrow keys to navigate the Snapshot list.
- Turn the Select knob in the ACS to scroll through the Snapshot list. Snapshot names appear in the display above the Select knob.

The current target snapshot is highlighted in red in the Snapshots list, and shown in red in the Status display.

## Recalling Snapshots

You can do the following when recalling snapshots:

- Target and instantly recall successive snapshots (next or previous)
- Target first, then recall one or more snapshots
- Select multiple snapshots and recall them all sequentially
- Target snapshots, change Data Type or Channel Scope settings, then recall.

 Undoing snapshot recall commands might cause audio to be interrupted. Use Undo with caution in performance.

### Recalling Successive Snapshots Instantly

You can instantly recall successive snapshots in the Snapshots list. This command references the previously recalled snapshot, not the last targeted snapshot.

### To instantly recall successive snapshots, do one of the following:

- On the console, press the Previous or Next switch in the Snapshots section.
- or –
- On-screen, click the Recall Previous (–) or Recall Next (+) button at the top of the Snapshots list.



**A** The Snapshot Recall buttons combine target and recall actions in one step, causing the previous or next snapshot to be instantly active. These buttons cannot be used to preview snapshots before recalling them.

### Targeting Before Recalling Snapshots

#### To target and then recall a snapshot:

- 1 Target the snapshot you want to recall by clicking the snapshot name in the Snapshot list, or turning the Select knob in the Snapshots section.
- 2 (Optional) Set the scope of the snapshot by doing the following:
  - For each channel you want to recall in the snapshot, click the channel so that it is scoped (displayed in red).
  - For each parameter of the scoped channels you want to recall in the snapshot, click the corresponding Data Type button so that it is scoped (displayed in red).
  - Configure the Recall Safe page to further filter snapshot data on recall. (See “Recall Safe and Channel Automation Safe” on page 184.)
- 3 Click the Recall button on-screen, or press the Recall switch in the Snapshots section.

**💡** Snapshot Recall can also be triggered by a footswitch or any number of other console functions in the Events window. For more information, see Chapter 22, “Events.”

### Selecting and Recalling Multiple Snapshots

You can select and recall multiple snapshots to load them all in sequence, and in one step. This is useful to quickly reset the console to a sub-cue or other specific point within a longer scene or cue and “pick up from there.”

#### To recall multiple snapshots:

- 1 Select multiple snapshots in the list (Shift-click to select multiple adjacent (contiguous) snapshots; Ctrl-click to select non-contiguous items or to deselect a single item).
- 2 Press the Recall switch, or click the Recall button on-screen.

**💡** If multiple snapshots are selected, toggling Data Type or Channel Scope buttons affects all selected snapshots. This provides a quick way of removing a channel or data type (such as EQ) from some or all snapshots. This action can be undone using the Undo button.

## Recall Safe and Channel Automation Safe

The Recall Safe tab in the Snapshots page provides global automation safe settings of nearly every section of the console.

You can also place individual channels in automation safe from the console or on-screen. For more information, see “Automation Safing Channels” on page 187.

### Recall Safe

Recall Safe lets you select which parameters on which channels you want to be ‘safed’ from snapshots.

Recall Safe is global to all snapshots, can be turned on or off quickly, and provides preset capabilities in the form of Scope Sets. Scope Sets can be loaded and saved just like Presets for built-in EQ, Dynamics, and plug-in settings. Current Recall Safe settings are stored with the Show file.

### Recall Safe Tab

The Recall Safe tab opens the Recall Safe page on-screen. The Recall Safe tab is red when Recall Safe is on and in effect, and gray when Recall Safe is off or when nothing is safed.



Indication of active Recall Safe from the main Snapshots page

### Recall Safe Displays and Controls

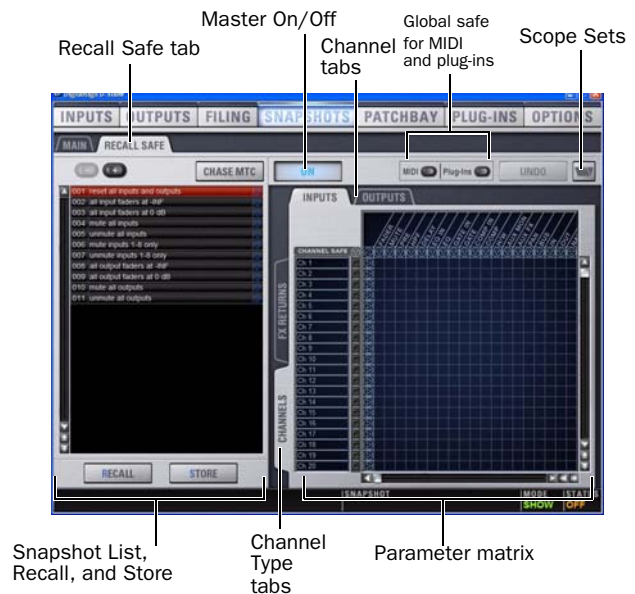

Displays and controls in the Recall Safe page

## On

The master On button toggles the entire Recall Safe feature on or off globally. When lit (blue), Recall Safe is active. When dark, Recall Safe is suspended.

## Snapshot List, Recall and Store

The Snapshot List and its Recall and Store functions remain visible and available from the Recall Safe page at all times.

## Channel Tabs

The Inputs and Outputs tabs at the top of the parameter matrix selects the channel type whose safe status you want to view or edit. Along the left side of the parameter matrix are channel Type selector tabs, which will change depending on whether you are viewing Input or Output tabs.

 *Shift-click channel type tabs to view more than one type at once in the scrollable parameter matrix.*

## Global Safe for MIDI Output and Plug-Ins

These checkboxes let you globally suspend recall of MIDI output and/or plug-in changes. They are considered separate from the parameter matrix and do not follow the Recall Safe master On (or Off) status.

## Scope Sets

Scope Sets are presets for the Recall Safe page that can be stored and loaded, just like plug-in, EQ and Dynamics presets. Scope sets can be used as a template when creating new shows, or used to change Recall Safe settings during a performance. Like other presets and settings files, Scope Sets can be transferred from the Filing page, making it easy to maintain and transfer Recall Safe configurations. For more information, see “Using Scope Sets” on page 187.

## Parameter Matrix

The parameter matrix is a scrollable grid in which you can safe parameters and channels. You can undo and redo parameter matrix operations.

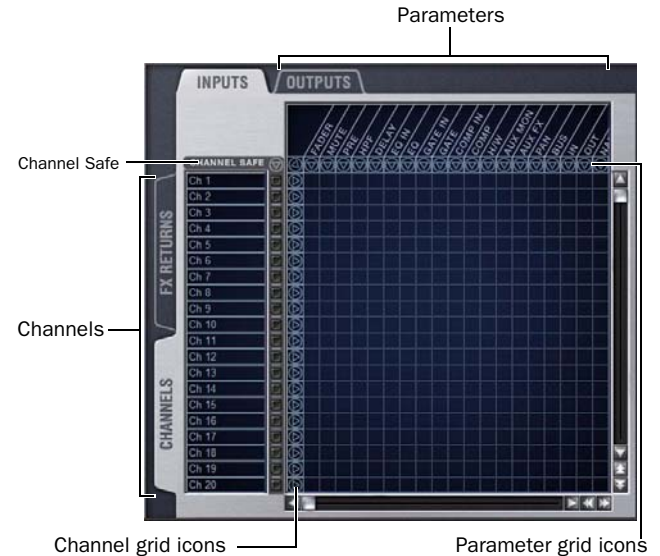

### Parameter matrix for Recall Safe

Parameters are represented in the columns of the parameter matrix; channels are listed along the left side in rows.

Clicking in the grid enables safe status for that parameter on that channel. Parameter and Channel grid icons provide shortcuts to “safe all” parameters in a single-click, and to safe entire channels. Clicking these icons lets you quickly toggle recall safe status for entire columns and rows. You can also use the master grid icon located in the upper left most corner to toggle the entire grid.

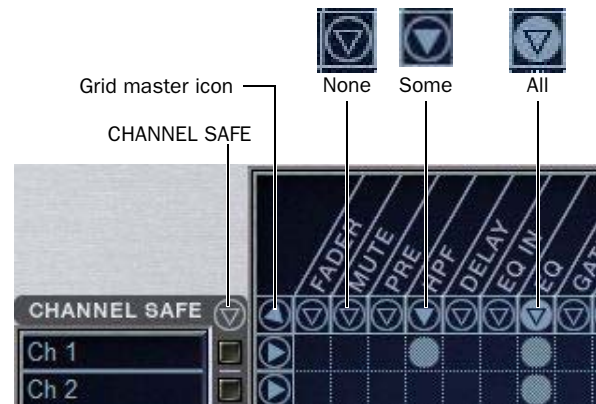

Display states for grid icons in Recall Safe

The display state of the Parameter and Channel grid icons indicate safe status for that column or row as follows:

**None** A dark Parameter or Channel grid icon indicates that no items in that column or row are safe enabled.

**Some** A dark triangle inside a lit blue circle indicates that at least one item in that column or row is safe enabled.

**All** A lit (white) triangle indicates that all items in that column or row are safe enabled.

### Channel Safe Controls

The CHANNEL SAFE column acts as a global “all channel” setting or override, mirroring the SAFE switch on the console and on-screen (when in Input Safe Switches act as Automation Safes mode).

Controls in the CHANNEL SAFE column are not part of the parameter matrix; they function *in addition to* the parameter matrix. As a result, you do not need to enable any CHANNEL SAFE settings to use the Recall Safe parameter matrix.

 For more information, see “Automation Safing Channels” on page 187.

### Using Recall Safe

#### To access the Recall Safe page:

- 1 Do one of the following:
  - Go to the Snapshots page and click the Recall Safe tab.
  - or –
  - Double-press the Snapshot View switch until the Recall Safe tab is displayed.
- 2 Click a channel type tab to display the desired channels.

#### To safe individual parameters on specific channels:

- Click in the grid at the intersection of the appropriate parameter (column) and channel (row). A blue dot appears, indicating a parameter is safed.



Enabling recall safe for channel 1 fader

#### To safe multiple parameters or channels at a time:

- Click and drag in a column, across a row, or at an angle.

#### To safe individual parameters or channels:

- 1 Place the cursor above the grid, above a parameter or channel name, or above any Channel Safe button. To be sure the cursor is above a valid area, you should be able to see at least one parameter name or channel name highlight.
- 2 Use the Arrow keys of the computer keyboard to move the cursor right, left, up, or down to other grid points. (You cannot navigate to parameter or channel grid icons, or to the Channel Safe column.)
- 3 Press Enter to enable or disable safe status for the currently focused grid point. Continue navigating to and toggling safe status of other parameters and channels.

#### To safe a parameter across all currently displayed channel types:

- Click the Parameter grid icon at the top of the appropriate column until the triangle is white.

#### To safe all parameters for a particular channel:

- Click the Channel grid icon in the ALL column for that channel (row).

#### To toggle the status of a parameter column or channel row:

- Click the appropriate Parameter or Channel grid icon repeatedly until it displays the desired status. For more information, see “Parameter Matrix” on page 185.

#### To safe all parameters across all channels and clear any current settings:

- Click the triangular icon at the top of the ALL column.

 You can undo or redo the last action taken in the parameter matrix.

### CHANNEL SAFE

#### To automation safe an individual channel and retain all recall safe settings for that channel:

- Click in the CHANNEL SAFE column for the desired channels.

 CHANNEL SAFE does not need to be lit in order to Recall Safe individual parameters for that channel.

#### To automation safe all parameters across all channels and retain all current recall safe settings:

- Click the CHANNEL SAFE master icon at the top of the Channel Safe column.

 The CHANNEL SAFE column mirrors the channel automation Safe controls. For more information, see “Automation Safing Channels” on page 187.

## MIDI

### To enable Recall Safe for MIDI Snapshot output:

- Click the MIDI Snapshot Output Safe button, located above the parameter matrix.

 For more information, see “Adding MIDI Messages to Snapshots” on page 195.

## Plug-Ins

### To enable Recall Safe for plug-ins:

- Click the Plug-In Snapshot Safe button, located above the parameter matrix.

 For more information, see “Adding Plug-In Data to Snapshots” on page 197.

## Matrix and PQ

Snapshots can store and recall all source assignments of each Matrix and PQ mixer when the Matrix (Mtx) and/or PQ data types is scoped. In addition, all User Input assignments are stored, letting you reconfigure Matrix or PQ mixers and User Input assignments on a per snapshot basis, if desired.

The Recall Safe tab of the Snapshots page provides three parameters for Matrix and PQ snapshot recall safe:

**MIX** Safes both Source and User assignments.

**MIX SRC** Safes only source inputs.

**MIX USER** Safes only user input assignments.

For a list of what can be stored and recalled in each snapshot, see “Snapshot Data Types and Parameters” on page 201.

## Using Scope Sets

Configurations of the Recall Safe page can be stored as Scope Set settings files. Scope Sets can be previewed, recalled and transferred just like plug-in, EQ and Dynamics settings.

### To store the current Recall Safe settings as a Scope Set:

- 1 Configure the Recall Safe page as desired.
- 2 Click the Scope Sets icon (the folder icon located above and to the right of the parameter matrix).
- 3 Click New.

### To preview and recall a saved Scope Set:

- 1 From the Recall Safe page, click the Scope Set icon to display the Scope Set window.
- 2 If necessary, choose the appropriate Scope Sets folder by clicking and selecting it from the Folder selector.

### 3 Do any of the following:

- To preview an existing Scope Set, click its name in the Scope Sets window.
- To load the currently selected Scope Set, press Enter or click the Close box (X) in the Scope Sets window title bar.
- To cancel without changing Recall Safe settings, click Cancel.



Scope Sets window

 See Chapter 20, “Shows and File Management” for complete information on transferring system data.

## Automation Safing Channels

Input Safe switches (both console and on-screen) can be set to Automation, Solo, or Bank Safe modes. When set to act as Automation Safes, the Input Safe Switches let you suspend the effect of snapshots on all parameters of individual Input Channels and FX Returns.

 You can also control channel automation safe status in the Recall Safe tab. See “CHANNEL SAFE” on page 186.

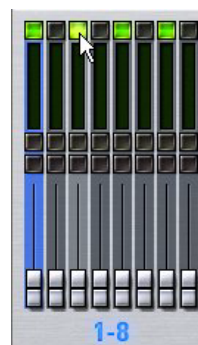

On-screen Automation Safe button

### To toggle the Safe status of an Input Channel or FX Return directly from the channel strip:

- 1 Go to the Options page and click the Interaction tab.



2 In the Input Safe Switches section, select the Act as Automation Safes option.

3 Press the Safe switch in the Input section, or click the on-screen Safe button for each of the Input Channels or FX Returns you want to safe. The Safe switch lights solid to indicate that the channel is automation safed.

 You can use the Event List to be able to cycle through the various Input Safe Switch modes using a footswitch, function switch or other available trigger. See Chapter 22, "Events."

## Managing Snapshots

You can manage snapshots in the list by storing, locking, clearing, duplicating, deleting, or moving them.

### Storing Snapshots

You can modify the contents of an existing snapshot, overwriting it with new settings, using the *Store* command. It is not necessary to recall a snapshot to store it. Snapshots can be stored from on-screen or from the snapshot controls on the console. You can undo Store commands.

#### To store the current console state in an existing snapshot:

- 1 Set all parameters on the console as you want them to be stored in the snapshot.
- 2 Select the snapshot in the on-screen Snapshot list, or turn the Select knob in the Snapshots section to target a snapshot you want to overwrite.
- 3 Click the Store button on-screen, or press the Store switch in the Snapshots section.
- 4 Set the scope by doing the following:
  - For each parameter you want to be affected when the snapshot is recalled, click the corresponding Data Type button so that it is scoped (displayed in red).
  - For each channel you want affected when the snapshot is recalled, click the channel fader so that it is scoped (displayed in red).

### Locking Snapshots

Snapshots can be *locked* to prevent them from being accidentally altered, overwritten or deleted.

Locked snapshots can be selected, recalled, moved and duplicated. They cannot be overwritten, renamed, rescoped or otherwise changed. New and duplicated snapshots default to unlocked. Lock status can be changed at any time, including while in Preview mode.

#### To lock a snapshot:

- 1 Go to the Main tab of the Snapshots page.
- 2 In the Snapshot list, click the padlock icon at the far right of the row for any item. The padlock icon illuminates to indicate the snapshot is now locked.

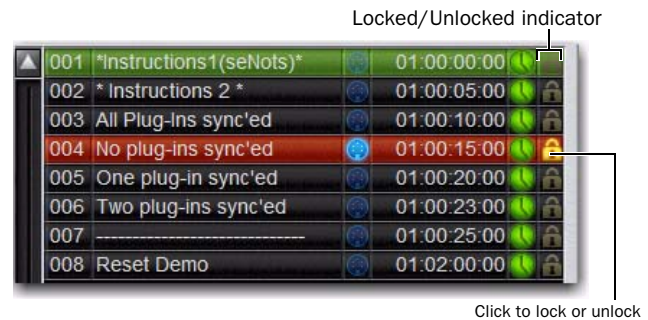

#### Snapshot lock controls

Select multiple snapshots using the Shift key or Multi-Select switch to lock or unlock multiple snapshots at once.

Once locked, operations that would otherwise affect the snapshot cause the Status display and channel LCDs and Snapshot LCD to temporarily show a message reminding you that the operation cannot be applied while the snapshot is locked.

#### To unlock a snapshot:

- Click the lit padlock icon in the row for that snapshot.

You can undo locking or unlocking of a snapshot by clicking the Undo button.

#### Undo and Locked Snapshots

You can undo locking or unlocking a snapshot. When toggling lock status for a selection of more than one snapshot, the entire operation creates a single undo point (it does not track and provide undo for each individual snapshot in the selection).

 **Keep in mind that Undo can revert snapshots to "unlocked" status. For example, if you change the scope of an unlocked snapshot, lock the snapshot and then use Undo, the snapshot is unlocked. Pressing Undo one more time will revert the snapshot to its original scope.**

#### Locking Snapshots and MIDI Record

When using the MIDI Record feature, all MIDI data captured up to the point a snapshot is locked is preserved. If the MIDI Record operation is still active at the time the snapshot is locked, record mode is exited, the REC button becomes unavailable for that snapshot, and subsequent incoming MIDI messages are not captured.

## Available Operations with Locked Snapshots

The following table details which operations can or can not be performed on a locked snapshot.

*Summary of allowed/disallowed operations when locked*

Operation	Allowed while Locked	Disallowed while locked
Select/target snapshot	X	
Recall snapshot	X	
Duplicate snapshot	X	
Re-sequence in snapshot list by:		
• Dragging in snapshot list	X	
• Manually editing sequence number	X	
• Re-sorting by time code	X	
Overwrite (Store to locked snapshot)		X
Propagate changes		X
Apply Edit mode changes		X
Clear		X
Delete		X
Modify Scope		X
Add/Modify stored MIDI data		X
Add/Modify stored Plug-In data		X
Modify Notes		X
Modify X-Fade time		X
Modify Snapshot Name		X
Modify Time Code Location		X
Toggle Time Code Enable		X
Undo changes	X	

## Clearing Snapshots

The contents of a snapshot can be cleared while keeping the snapshot in the Snapshot list and retaining its MTC information. This lets you maintain a placeholder that you can use later to store new data. You can undo Clear commands.

**To clear the contents of a snapshot:**

- 1 Select the snapshots you want to clear.
- 2 Click Clear. Cleared snapshots are renamed "<Empty>."

## Duplicating Snapshots

Snapshots can be duplicated from the Snapshots list. You can undo Duplicate commands.

**To duplicate snapshots:**

- 1 Select the snapshots you want to duplicate.
- 2 Do one of the following:
  - Click Dup (Duplicate).
  - or –
  - Right-click the snapshot name and choose Duplicate.

A copy of each selected snapshot is placed after the selection, with a plus sign (+) appended to the original snapshot name.

If multiple snapshots are selected in the list, the new (duplicate) items are added below their original source snapshots.

## Deleting Snapshots

Snapshots can be deleted from the Snapshots list. You can undo Delete commands.

**To delete snapshots:**

- 1 Select the snapshots you want to delete.
- 2 Do one of the following:
  - Click Del (Delete).
  - or –
  - Right-click the snapshot name and choose Delete.

The snapshots are removed from the Snapshots list, and succeeding snapshots are renumbered.

## Moving Snapshots

Existing snapshots can be rearranged in the Snapshots list. When you move one or more snapshots, they are automatically renumbered in the list, but MTC values are left unchanged. You can undo a snapshot move.

**To move a snapshot, do one of the following:**

- Drag the currently selected snapshots to a new location in the Snapshots list.
- or –
- Double-click the snapshot number in the Snapshots list or the banner display, type a new number, and press Enter on the keyboard.

## Making Changes to Snapshots

There may be situations where you need to change specific parameters in existing snapshots while leaving other parameters unchanged.

For example, if a guitarist changes instruments in the middle of a tour it might be necessary to change levels and EQ on the guitar channel in all the snapshots in a show. Snapshots provides the following modes to accommodate these types of situations:

**Edit Mode** Lets you capture individual control changes while you mix, and apply those changes to one or more pre-existing snapshots as absolute or relative changes. For example, you could enter Edit mode the first time a guitarist uses a new guitar in rehearsal. When you are satisfied with your settings you can apply them (in absolute or relative fashion) to update other snapshots. See “Using Edit Mode” on page 190.

**Propagate Mode** Lets you update data in pre-existing snapshots after you've already made changes and decided you want to keep them. While Edit mode requires you to know ahead of time that you will be updating snapshots, Propagate mode lets you decide to update other snapshots with current settings after making adjustments to your mix. For example, if its the third consecutive night you've reached to increase gain on the DI channel for a new guitar, you could use Propagate mode to quickly take the gain increase you just made and apply it to other snapshots. See “Using Propagate Mode” on page 191.

 *Events-driven recall of snapshots is disabled while in Propagate or Edit mode. For more information, see Chapter 22, “Events.”*

## Using Edit Mode

Edit mode is a powerful way to update specific parameters across multiple snapshots without overwriting any settings you want to preserve. By entering Edit mode before making adjustments, you can edit a single control or any number of controls, and your changes are tracked from the point Edit mode was entered.

 *The ability to edit a single control in Edit mode provides more selectivity than Propagate mode.*

## Absolute and Relative Edits

Changes can be applied to one or more selected snapshots as *absolute* or *relative* values. Any parameter can be edited in absolute fashion; all dB parameters can be edited in relative fashion.

## Examples of Absolute and Relative Edits

**Absolute** Changing a fader level from 0 dB to -3 dB and applying that change as Absolute results in that fader being set identically to -3 dB in all selected snapshots.

**Relative** Changing a fader level from 0 to -3 dB and applying that change as Relative results in that fader being reduced by that amount in all selected snapshots, or 3 dB relative to the value previously stored in the snapshot(s). For example, a channel previously at -6 dB would be changed to -9 dB.

## Making Relative Changes with Mixed Data Types

If a combination of dB and non-dB parameters (such as gain and EQ frequency) are edited and applied in relative fashion, the dB parameters are adjusted as relative (delta) changes and the non-dB are applied as absolute changes.

**To update specific parameters in existing snapshots using Edit mode:**

- 1 Navigate to the main Snapshots page.
- 2 Click the Edit button to enter Edit mode. The Edit button changes into two smaller flashing buttons: Abs, and Rel. The system begins tracking all changes while you make them.



**Edit mode**

- 3 Adjust any combination of snapshottable parameters on the console or on-screen.
- 4 Select the snapshot(s) to which you want to apply your edits.
- 5 Click either of the flashing buttons Abs (for Absolute) or Rel (for Relative). You can cancel Edit mode by pressing the Cancel button on the control surface, clicking the Cancel button on-screen, or by pressing the ESC key on your computer keyboard.

The selected snapshots are updated according to your changes and your choice of Absolute or Relative edit.



## Using Propagate Mode

You can use the Propagate command to capture changes and apply them to existing snapshots. Propagate mode is most useful when you realize during the course of mixing that you want to capture your current settings to use in other snapshots. You can undo Propagate commands.

### To update specific parameters in existing snapshots:

- 1 Make sure the channel is set as needed.
- 2 Click Propagate. The current data and channel scope is cleared.
- 3 Set the scope to reflect only those parameters you want to update by doing the following:
  - For each parameter you want to update, click the corresponding Data Type button so that it is scoped (displayed in red).
  - and –
  - For each channel you want to update, press its channel Select switch on the console, or click the channel on-screen so that it is scoped (displayed in red).



Propagating an EQ change for a channel

- 4 Select the snapshot or range of snapshots you want to update in the Snapshots list.
- 5 Click Propagate. The scoped parameters are updated in the selected snapshots.

## Preview Mode

Preview mode lets you recall, store and edit snapshots without affecting the current mix.

When enabled, Preview mode takes the console offline from the live audio mix so you can “work ahead” during a rehearsal, performance or event to preview upcoming snapshots and edit them as needed. Any control that can be stored and recalled by snapshots is available while in Preview mode, and you can also modify the Snapshot List. Once you are done previewing or editing snapshots, you can store your changes to update the existing snapshots with your changes.

## Using Preview Mode

### The basic workflow for using Preview mode is as follows:

- 1 Make sure your active mix is set as desired, and make sure the rehearsal, event or performance has an upcoming opportunity for you to go offline.
- 2 Enter Preview mode by clicking the on-screen Preview button in the main Snapshots page. The word PREVIEW flashes in red across the screen for confirmation. (By default, the Function switch F1 is assigned to Preview mode, but this can be customized using Events. For more information, see Chapter 22, “Events.”)



Preview mode

- 3 Do any of the following:

**Edit the Snapshots List** Reorder snapshots in the list, if desired, by clicking and dragging them. Changes to the order of items in the Snapshots list may affect the current active mix if the affected snapshots rely on MIDI or MTC triggering. (For more information, see “Changing Console Settings in Preview Mode” on page 192.)

**Create a New Snapshot** Adjust settings as desired and create a new snapshot by clicking New. (See “Creating New Snapshots” on page 182.)

**Recall and Edit an Existing Snapshot** Recall a snapshot to preview its settings and make any adjustments necessary, being sure to re-store the snapshot before exiting Preview mode. Storing a snapshot in Preview mode does not affect previously stored MIDI or Plug-in data (if any).

**Edit Channel and Scope Settings** Edit any channel settings, parameters, or scope associated with the snapshot being previewed. The Snapshots page displays the current snapshot name in italics to indicate that at least one parameter has been changed, and the Channel Faders show you the previous level for each channel in bright red. Scope Data Type buttons and Channel Scope functionality remain live and active at all times (in other words, changes made to these controls while in Preview mode will remain once Preview mode is exited).

**Add and Edit MIDI or Plug-In Data** To add MIDI or plug-in data associated with the snapshot, click the Add button in the MIDI or Plug-Ins snapshot list. With plug-ins this adds the current online plug-in settings to the snapshot. If you need to update pre-existing MIDI or plug-in data associated with a snapshot, right-click the corresponding entry in the MIDI/Plug-ins view of the Snapshots page and choose the Update option (this option will include the plug-in rack position, and the name of the associated snapshot). For more information, see “Plug-Ins and MIDI in Preview Mode” on page 193.

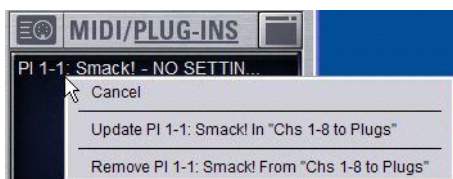

Updating snapshot plug-in data

**4** To undo an action made while in Preview mode, click the Undo button on-screen. (For more information about Undo in Preview mode, see “Making Changes to Snapshots” on page 190.)

**5** To update the currently previewed snapshot but remain in Preview mode, press or click Store.

**6** Continue previewing and editing settings as needed (all snapshot functions are available in preview mode).

**7** When you are finished and need to exit Preview mode, press F1 (or click the on-screen Preview button).

**⚠** *Exiting Preview mode without storing will discard the changes made while in Preview mode (Preview mode is cleared each time you exit). You must explicitly store changes to update the associated snapshots.*

## Undo and Preview Mode

In Preview mode, you can Undo actions applied to the Snapshot List (such as Recall, Store, New and Duplicate) without affecting the online mix.

 *Multiple levels of Undo are available.*

### Changing Console Settings in Preview Mode

The system tracks any changes to console settings or to the Snapshot List while in Preview mode, but only Snapshot List actions create an Undo point. Choosing Undo will undo the last action you took while in Preview mode, up to a maximum of 100 levels of Undo. Any changes to console settings made after the last Preview action are also undone (the Snapshot screen is returned to its exact state prior to the action that created the Undo point).

### Changing the Snapshot List in Preview Mode

Changes made to the Snapshot List are automatically tracked and available for Undo, regardless of whether Preview mode is enabled or not. This includes any Recall of snapshots triggered by incoming MIDI or MTC while in Preview mode.

For example, if a MIDI Snapshot Recall occurs while you are in Preview mode, the online mix will be updated with that snapshot. Pressing Undo immediately after that Recall will undo that Snapshot recall and revert the online mix to its state prior to the Undo.

Consider turning off the Chase MTC option while in Preview mode to disable all MIDI recall of snapshots. In addition, you can always use the History feature to recover from any unexpected results.

### Changing MIDI or Plug-In Data in Preview Mode

Changes made to MIDI and Plug-In data cannot be undone. For more information, see “Adding MIDI Messages to Snapshots” on page 195 and “Adding Plug-In Data to Snapshots” on page 197.

 *Take advantage of Tool Tips in the banner display to confirm what action the Undo button will revert. See “Undoing Snapshot Commands” on page 194.*

## Available and Unavailable Functions in Preview Mode

In order to maintain essential mix indicators and controls while in Preview mode, not all functions are taken offline.

The following sections detail what is and what is not available during Preview mode.

### Always Active

Certain essential mix functions remain live and active at all times, regardless of whether Preview mode is enabled. The following vital mix functions continue to affect or be affected by the console and software:

- Metering (including input, output and dynamics meters, clip and bank clip indicators)
- AFL/PFL
- Dynamics Key Listen
- Monitoring level, Headphone level and Monitoring bus Delay
- Talkback, Osc and 2-Track
- Mute Groups (recall only)
- Recall Safe
- MIDI snapshot Recall, Chase MTC and Disable (Snapshots)
- Snapshot List and Recall Safe (deleting, adding, or editing snapshots are/will be reflected online and affect the mix)
- History (auto-save)

### Recall Safe in Preview Mode

The Recall Safe settings are global, and are applied to filter snapshot data regardless of the current operating mode. For details on Recall Safe and other automation safe features, see “Recall Safe and Channel Automation Safe” on page 184.

### Available and Editable in Preview Mode

Almost all system functions, such as selecting channels and banking faders, are available in Preview mode.

 Only those controls that can be stored and recalled via snapshots are available for offline previewing and editing.

## Not Available in Preview Mode

The only controls not available while in Preview mode are those controls which are not able to be stored or recalled via snapshots. In addition, Config mode options are unavailable in Preview mode.

Unavailable functions include the following:

- Make Stereo, or Split to Mono
- Move channels
- Input channel Gain Guess
- Input channel and FX Return Input Direct switch
- Input channel Dyn Pre EQ switch
- Insert mode (plug-ins cannot be edited)
- Enabling or disabling sample rate conversion

 These functions are neither available for offline access in Preview mode, nor do they remain active (online) while in Preview mode. To adjust any of the above settings, you must exit Preview mode.

### Config Mode

Config mode is not available while in Preview mode. Pressing the Config switch (or double-clicking the Config/Show mode icon on-screen) displays a dialog box in which you can choose to “Exit Preview” (return to online mix, in Config mode), or “OK” (remain in Preview mode).

The system automatically switches to Show mode if Config mode is active at the time Preview mode is entered.

### Plug-Ins and MIDI in Preview Mode

In Preview mode, plug-ins and MIDI operate in a similar way as when using the standalone software.

#### Plug-Ins in Preview Mode

Recalling a snapshot that contains plug-in data affects the offline (Preview) routing and bypass state of the plug-in only; the online plug-in parameter settings are not recalled, and the online mix is not affected.

The following plug-in functions are available offline in Preview mode:

- Plug-in routing can be changed
- Plug-in rack view can be changed
- Plug-ins can be added to a snapshot to capture its current online parameter settings and (Preview mode) routing

The following plug-in functions are not available while in Preview mode:

- Plug-ins cannot be added to or removed from rack slots
- Plug-in presets cannot be recalled or saved
- Plug-in parameters cannot be changed (you cannot open plug-in windows while in Preview mode)
- Plug-ins cannot be installed

You must explicitly add or update plug-in (or MIDI) data to update snapshots, whether or not Preview mode is enabled. You can do this from the main Snapshot page, or from the plug-in racks.



Updating plug-in data in an associated snapshot from the plug-in view

### MIDI in Preview Mode

Incoming MIDI or MTC continues to trigger snapshot recall while in Preview mode. However, MIDI messages stored to snapshots are not sent out when a snapshot is recalled in Preview mode. For more information, see “Adding MIDI Messages to Snapshots” on page 195 and “Adding Plug-In Data to Snapshots” on page 197.

### MTC and Other Online Event Triggers

While in Preview mode, triggers that occur in the online state of the console are executed, including MTC-driven recall of snapshots. Triggers caused by changes to the offline (Preview) controls are ignored and do not cause events to occur. For more information, see Chapter 22, “Events.”

## Undoing Snapshot Commands

The Undo function returns the console to the state immediately before the last snapshot command. Undo is multi-level (up to 100), is available while in Preview mode and after performing an Edit or Propagate mode action.

**⚠** Undoing snapshot recall commands may cause audio to be interrupted. Use Undo with caution in performance.

- ◆ If the Undo button is highlighted, you can place the cursor over the button to display text in the status bar describing what snapshot actions will be undone.
- ◆ If the Undo button is dimmed, Undo is not available.

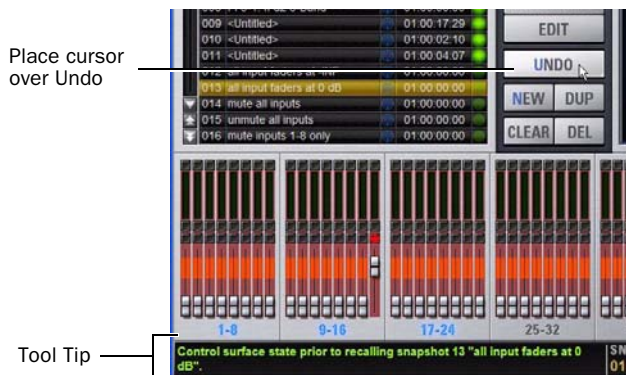

Using Tool Tips to verify the effect of Undo in the Snapshots page

### To undo a snapshot command:

- Click the Undo button in the Snapshot commands section.

## Disabling Snapshots

You can temporarily disable the storage and recall of all snapshots. While snapshots are globally disabled, you can target snapshots in the Snapshots List to preview their properties, but you cannot recall them.

### To disable all snapshots:

- Click the Disable button in the Snapshot commands section.

### Suspend MTC Recall

#### To disable MTC Recall of individual snapshots in the list:

- 1 Click the green Enable icon in the row for the desired snapshot so that it is unlit.
- 2 Click the Disable/Enable icon again to re-enable the snapshot.

You can similarly suspend Tempo on a per snapshot basis (see “Adding Tempo Data to Snapshots” on page 196).



## Adding MIDI Messages to Snapshots

No MIDI message data is captured when a snapshot is first created. MIDI messages are added to existing snapshots directly from the MIDI list. You can store up to 20 MIDI messages in each snapshot.

When the MIDI data type is scoped for a snapshot, any stored MIDI messages are sent when the snapshot is recalled.

The following MIDI messages are supported and available in the MIDI list:

- Note Off
- Note On
- Poly Key Pressure
- Control Change
- Program Change
- Channel Pressure
- Pitch Bend
- MIDI Machine Control Stop
- MIDI Machine Control Play
- MIDI Machine Control Fast Forward
- MIDI Machine Control Rewind
- MIDI Machine Control Eject
- MIDI Machine Control Chase
- MIDI Machine Control Pause
- MIDI Machine Control Locate

When the MIDI data type is scoped for a snapshot, its MIDI messages are sent when the snapshot is recalled.

	MIDI Message Indicator	MTC Enable Icon
001 Snap 001		
002 Snap 002		
003 Snap 003		
004 Snap 004		
005 Snap 005		
006 Snap 006		
007 Snap 007		
008 Snap 008		

Snapshots List showing snapshot containing MIDI messages

### To add a MIDI message to a snapshot:

- 1 Target the snapshot you want to modify.
- 2 Double-click the word MIDI in the MIDI/Plug-Ins list header to expand the MIDI list.

- 3 Click Add and choose a message from the pop-up menu.



### Adding a message to the Snapshot MIDI list

A MIDI plug icon appears in the Snapshots List for each snapshot that contains MIDI messages.

### To record incoming MIDI data to a snapshot.

- 1 Click REC.
- 2 Send a supported MIDI command.
- 3 Click REC again when done.

### To edit a MIDI message in the MIDI list:

- 1 Double-click the message text to display the pop-up menu bar for the message.

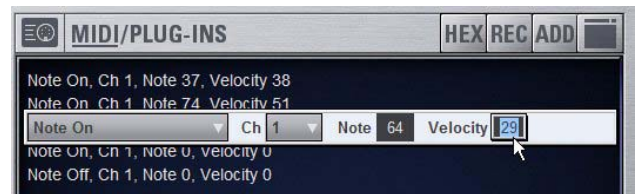

### Editing a MIDI message in the snapshot MIDI list

- 2 Choose the message name and send channel or device ID from the pop-up menus.
- 3 Enter the message values in the text fields or drag up or down across the text field to change the values.
- 4 Click in the MIDI list area to dismiss the pop-up menu bar.

### To remove a MIDI message from a snapshot:

- Right-click the MIDI message in the MIDI list and choose Delete.

## Viewing MIDI Messages in Hexadecimal Format

You can toggle the view of MIDI messages in the MIDI list between hexadecimal and decimal formats.

### To toggle the view format of the MIDI list:

- Click the Hex button in the MIDI/Plug-Ins list header.

## Safing MIDI Message Output

You can temporarily disable output of embedded MIDI messages so that they are not sent when a snapshot is recalled, even when the MIDI data type is scoped.

 *MIDI output is automatically suspended while in Preview mode.*

### To safe MIDI message output on-screen:

- 1 Go to the Snapshots page and click the Recall Safe tab.
- 2 Click the MIDI global output Safe button above the parameter matrix so that it is lit.

---

## Adding Tempo Data to Snapshots

The Snapshots List can be toggled to display Tempo, along with a Tempo On/Off indicator for each snapshot entry.

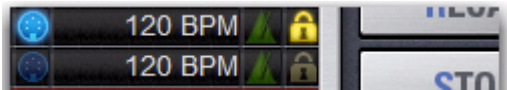

*Snapshots List showing tempo*

Storing a tempo with snapshots lets your system tempo change per song or scene. This lets you take full advantage of Tempo Sync (aka Tap Tempo) to synchronize delay and echo plug-ins.

### Displaying Tempo in the Snapshots List

#### To show Tempo in the Snapshots List:

- Right-click anywhere in the Snapshots List and choose Show Tempo.

Tempo is displayed in BPM (beats per minute) or milliseconds, as set in the Options > Misc page.

#### To change the units for Tempo display:

- 1 Go to the Options > Misc page.
- 2 In the Tap Tempo section, click to select BPM or ms.

### Assigning and Enabling a Tempo

Each snapshot can store a custom tempo value. You can manually enter a custom tempo, or use a shortcut to assign the current System Tempo.

You can use the Tempo Enable icon to enable or disable tempo recall when the associated snapshot is recalled.

#### To assign a Tempo value to a snapshot manually:

- 1 In the Snapshots List, double-click the Tempo value you want to change, then do one of the following:

- From the keyboard, type a new tempo value.
- or –
- Press the Up and Down Arrow keys to increase and decrease the selected value.

- 2 Press Enter or click another snapshot Tempo value to confirm the entry.

#### To assign the current System Tempo to a snapshot:

- 1 Make sure Tempo is shown in the Snapshots List.
- 2 Right-click and choose the Set Tempo to option, which will display the current System Tempo.

The System Tempo is set in the Options > Misc page. For details on configuring the system tempo and using it to synchronize plug-ins, see “Tap Tempo for Plug-ins” on page 213.

#### To toggle tempo on/off for each snapshot:

- 1 Make sure Tempo is shown in the Snapshots List (if not, right-click any item in the list and choose Show Tempo).
- 2 Click the Tempo icon so that it is lit (enabled) or unlit (disabled).

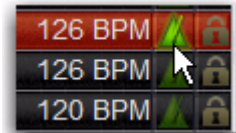

*Snapshots List showing tempo*

For more information on enabling Events for Tap Tempo, see “Tap Tempo for Plug-ins” on page 213.

---

## Pro Tools Markers and Snapshots

On systems with VENUE Link enabled, snapshots can be configured to create a marker (Memory Location) in the Pro Tools timeline when that snapshot is recalled. Marker status can be shown in the Snapshot List for all snapshots, and toggled on/off.

For complete information on this and other VENUE Link features, see the *Live Recording Guide*.

## Adding Plug-In Data to Snapshots

No Plug-In data is captured when a snapshot is first created. Plug-In data is added to existing snapshots from the Plug-Ins list or from the Plug-In rack.

When the Plug-In data type is scoped for a snapshot, plug-in routing, in/out state, and settings are recalled with the snapshot. (Adding or changing plug-in side-chain routing is not supported in snapshots.)

The Snapshots Plug-Ins list lets you select multiple plug-ins and add, remove and update them simultaneously across one or multiple snapshots. Multiple snapshots can be selected, and others can be added to or removed from the selection, at any time prior to adding, removing, or updating plug-ins and snapshots.

## Plug-Ins List

To view plug-in data for snapshots in the MIDI/Plug-Ins list:

- 1 Target the snapshot you want to modify, or select multiple snapshots in the list.
- 2 Double-click Plug-Ins in the MIDI/Plug-Ins list header to expand the Plug-In list.

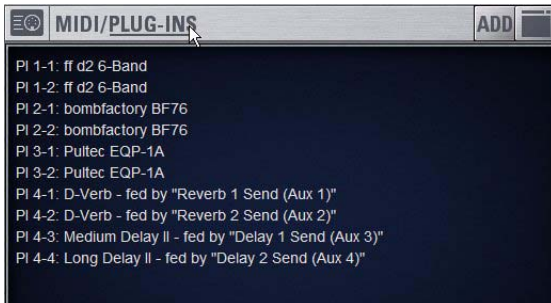

Expanded Plug-In list

It is also possible to select multiple plug-ins in the Snapshots Plug-Ins list and remove or update these plug-ins across multiple snapshots using Right-click commands. Selections can be contiguous or non-contiguous plug-ins in the list. This lets you more easily manage all plug-ins inserted on a single channel, for example.



Managing multiple plug-ins across multiple snapshots

## Adding Plug-Ins to Snapshots

To add a plug-in to one or more snapshots from the Snapshots page:

- 1 Select an individual snapshot, or create a multi-selection of snapshots in the Snapshots list.
- 2 Display the Plug-Ins List (see "Plug-Ins List" on page 197).
- 3 Click the ADD button within the Snapshot Plug-Ins list and select a plug-in (or All Plug-Ins) from the menu.

To add a plug-in to multiple snapshots from the Plug-Ins page:

- 1 Create a multi-selection of snapshots on the Snapshots page
- 2 Go to the Plug-Ins page.
- 3 Click the Snapshots menu for the plug-in to be added and choose Add This Plug-In To Selected Snapshots. The selected plug-in is added to the currently targeted snapshot, as well as all other snapshots within the multi-selection.

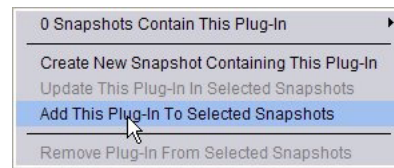

Using the Snapshots pop-up menu in the plug-in rack (Plug-Ins page)

Snapshots within the multi-selection that already contained the plug-in being added are unaffected and preserve any previously stored settings.

## Removing a Plug-In from Snapshots

To remove a plug-in from snapshots from the Snapshots page:

- 1 Select an individual snapshot, or create a multi-selection of snapshots in the Snapshots List.
- 2 Click the Snapshots Plug-Ins icon to show the Snapshots Plug-Ins list.
- 3 Right-click a plug-in within the plug-in list of the currently targeted snapshot and choose Remove This Plug-In From Selected Snapshots.

To remove a plug-in from multiple snapshots from the Plug-Ins page:

- 1 Create a multi-selection of snapshots on the Snapshots page
- 2 Go to the Plug-Ins page.
- 3 Click the Snapshot menu for the plug-in to be removed and choose Remove This Plug-In From Selected Snapshots.

The selected plug-in is removed from the currently targeted snapshot, as well as all other snapshots within the multi-selection. Only snapshots within the multi-selection that contain the selected plug-in are affected.



## Updating a Plug-In Across Multiple Snapshots

To update a plug-in across snapshots from the Snapshots page:

- 1 Select an individual snapshot, or create a multi-selection of snapshots on the Snapshots page.
- 2 Select a plug-in within the plug-in list of the currently targeted snapshot.
- 3 Right-click and choose Update Plug-In In Selected Snapshots.



*Snapshots plug-ins pop-up menu with multiple plug-ins selected in the Snapshots page*

To update a plug-in across multiple snapshots from the Plug-Ins page:

- 1 Create a multi-selection of snapshots on the Snapshots page
- 2 Go to the Plug-Ins page. All plug-ins that are associated with any of the currently selected snapshots are identifiable by their red Snapshot menu.
- 3 Click the Snapshots menu for the plug-in to be updated and choose Update This Plug-In In Selected Snapshots.

The selected plug-in is updated within the currently targeted snapshot, as well as all other snapshots within the multi-selection. Snapshots within the multi-selection that do not already contain the plug-in being added are unaffected.

## Editing Plug-Ins

The Snapshot page provides two ways to quickly navigate to a plug-in in order to edit its routing assignment or parameters.

To edit a plug-in associated with a snapshot:

- Double-click the item in the Snapshot Plug-Ins list. Or, right-click a plug-in in the Snapshots Plug-Ins list and choose Edit Plug-In.

## Snapshot Options

The Options > Snapshots page provides Snapshot General Preference settings for centering the snapshot list, and for optimizing crossfades between snapshots.

The next section explains how to utilize snapshot crossfade. (For information on the Center Last Recalled Snapshot preference, see “Centering the Snapshot List” on page 182.)

## Snapshot Crossfades

All snapshots provide a Crossfade setting that determines how long scoped faders will crossfade to the stored values in that snapshot when it is recalled. The Options > Snapshots page provides Snapshot General Preference settings for optimizing crossfades between snapshots.



*Snapshot preferences in the Options > Snapshots screen*

**Default Time** Defines a Crossfade time to apply to all new snapshots.

**Pan, Balance & Width** Enables pan, balance and width on scoped channels to crossfade.

Faders can be crossfaded on all channel types. Pan, balance, and width can crossfade on input channels, FX Returns, Groups, and PQ outputs. In order to crossfade, the desired channels must be scoped, and both Fader and Pan data types must also be scoped.

To configure snapshot crossfade:

- 1 Go to the Options page and click the Snapshots tab.
- 2 In the Snapshot General Preferences section, enter a non-zero value for Default Crossfade Time. Maximum crossfade time is 99.9 seconds.
- 3 To have pan parameters follow the snapshot crossfade time, click to enable the Pan, Balance & Width setting. (See “Pan, Balance and Width Crossfade Reference” on page 200.)
- 4 Go to the Snapshots page and make sure to scope the desired channels by clicking to select them in the fader display.
- 5 Click to scope Fader and/or Pan as needed in the appropriate snapshots. (For a listing of parameters by data type, see “Pan, Balance and Width Crossfade Reference” on page 200.)

## **Special Cases for Crossfade Bypass**

### **Incoming MIDI Commands**

The snapshot crossfade is not bypassed if a MIDI Program Change message recalling the same snapshot is received during the crossfade.

### **MTC**

The snapshot crossfade is not bypassed if a MTC trigger recalling the same snapshot occurs during the crossfade.

### **Multiple Simultaneous Crossfades**

The crossfade can be bypassed for the most recently recalled snapshot only.

### **Preview Mode**

If you enter Preview mode in between Recall commands, the offline (Preview mode) crossfade will be bypassed; the online crossfade will not.

## Pan, Balance and Width Crossfade Reference

### Pan, Balance and Width Crossfade Parameter Reference

			Pan	Balance	Width
Inputs†	Input Channel	Mono	X		
		Stereo		X	X
	FX Return	Stereo		X	X
Output Masters††	Aux	Mono/Stereo-linked			
	PQ			X	
	Matrix	Mono/Stereo-linked			
	Groups	Mono	X		
		Stereo		X	X
	Variable Groups	Mono/Stereo-linked	X		

† Crossfade does not apply to Pan for channel Aux sends.

†† Crossfade does not apply to Pan for input sources within the Matrix or PQ mixer.

## Pre Settings

Snapshots can be used to recall the preamplifier settings on inputs for all scoped Input Channels. You can set any of the following Pre parameters to be recalled by the Pre data type button: Gain, Pad and Phase/polarity, +48V (Phantom Power), HPF corner frequency and in/out state.

### To set the Pre parameters recalled by the Pre Data Type button:

- 1 Go to the Options page and click the Snapshot tab.
- 2 Under Pre, select the options you want to include. Selected items will be affected when the Pre data type is included in the scope of a snapshot.



Setting Pre parameters

## Classifying Aux Sends

You can classify Aux Sends as *monitor sends* (“Mon”) or as *effects sends* (“FX”), which lets you scope each type separately from the Snapshots page.

 This option is only a means of organizing Aux Sends for snapshot control, and does not directly affect Aux bus operation.

### To classify Aux Sends for snapshot scope:

- 1 Go to the Options page and click the Snapshots tab.
- 2 For each Aux Send bus or bus pair, click the Aux Mon or Aux FX buttons to classify it as a monitor send or effects send, respectively.



Classifying Aux Sends

### Aux Pre/Post State

Select this option to include the pickoff point pre-fader or post-fader state of each Aux Send in snapshots.

## Snapshot Data Types and Parameters

Table 22. Snapshot data types and parameters included in each data type

Snapshot Data Type	Included Parameters (for Each Scoped Channel Strip)
Fader	Main volume level
Mute	Mute state
EQ	EQ type selection (analog/digital); EQ in-circuit state; 4 bands (2 bands on FX Returns) of gain, freq, Q, bell/shelf selection (digital only), band on/off
Dyn	Compressor/Limiter in-circuit state; threshold, ratio, attack, release, knee, makeup gain Expander/Gate in-circuit state; threshold, ratio, attack, release, hold time, range, side-chain input
Pan	Channel pan or balance/width (For details, see “Pan, Balance and Width Crossfade Reference” on page 200.)
Bus	Group bus assignments, group bus mono/stereo-linked state (if mono groups) or dual-mono/true stereo state (if stereo groups), L-R bus assignment and C/M bus assignments for input strips and groups
In	Input routing for Input Channels and FX Returns
Out	Main out assignments; direct out assignments, level, in-circuit state, & tap-off point (excluding VCAs)
H/W	Hardware insert routing and in-circuit state (excluding VCAs)
VCA	VCA membership
Pre	Gain, pad, phase, phantom power, HPF corner frequency & in-circuit state
Name	Name for each strip
MTX	Mixer Input Sources, User Input Assignments, and pickoffs; Mixer Input level, Mixer Input on/off and Mixer Input Link state
PQ	Mixer Input Sources, User Input Assignment, and pickoffs; Mixer Input level, pan, and on/off state, Mixer input Link state, Llimiter threshold and Llimiter in/out
Aux Mon	On/off, pre/post selection, level, and pan/balance for each Aux bus classified as a Monitor Aux
Aux FX	On/off, pre/post selection, level, and pan/balance for each Aux bus classified as an FX Aux
Dly	Channel delay time & in-circuit
MIDI	All MIDI messages that were added to the associated MIDI list for that snapshot.
Plug-Ins	Rack slot settings, in-circuit state, and I/O routing for each plug-in added to plug-ins list for that snapshot



# Chapter 22: Events

This chapter introduces the Events window, and explains how to use the Event List.

---

## Introduction

An *event* consists of one or more *triggers*, which are configured to cause one or more *actions* to occur.

Events can be very simple, such as a Footswitch input triggering a Recall Next Snapshot command. This is an example of a single *trigger* (a footswitch input) causing a single *action* (Recall Next Snapshot).

Events can also be quite complex and involve multiple triggers and actions. For example, a single event can be defined so that moving a specific fader above and/or below a certain level sends a General Purpose output, recalls a specific snapshot *and* mutes one or more channels. Multiple triggers can be considered conditionally using the available logic operators AND, OR, and XOR.

The Event List is easy to configure, and many preconfigured events are provided for Tap Tempo, snapshot Preview mode and other functions.

 *For more information on the default events and other examples, see “Default Settings, Templates and Examples” on page 212.*

## Terminology

**Event** A user-defined combination of one or more triggers and one or more actions. Each event serves as a type of software “macro” in which you establish a cause-and-effect relationship between one or more console functions (triggers) and their results (actions).

**Trigger** A conditional check used to fire an event.

**Action** A console function, mode or other response resulting from an event being triggered.

**GPI** General Purpose Interface, also commonly known as a logic interface.

**Open** GPI input or GPI output is floating, or at its reference voltage.

**Closed** GPI input or GPI output is closed.

**Footswitch** Footswitch ports are functionally identical to GPI inputs and share all of the same properties and behaviors.

## Important Information about Snapshots and Events

Because Events can trigger snapshot recalls, and because snapshot recalls can trigger other events, it is possible to create logic “feedback loops.” For more information, see “Avoid Feedback Loops” on page 211.

# The Events Window

The Events window is the working area of the Event List system, and is available in the Options page (Options > Events).



Figure 18. Events window (Options > Events)

Events are defined and managed from the upper Event List area of the Events window. This area includes the scrollable Event List at the left, plus the Triggers and Actions sections to its right. The lists and commands available in these sections create a powerful, user-programmable environment.

## Events

An *event* consists of one or more *triggers*, which in turn cause one or more *actions* to occur. Up to 999 events can be created. Each event can have between 0 and 8 triggers, and each event can have between 0 and 8 actions.

**Event List** Each event is shown in its own row within the Event List. The list can be scrolled vertically when necessary.

**Event Number** Each event has an associated three digit sequence number, 001 through 999. Events are automatically re-numbered if items are moved, added or removed.

**Event Name** Events can be given custom names, up to a maximum length of 31 characters.

**Event Enable Icon** Events can be enabled or disabled individually by clicking the green Enable indicator to toggle its status. All events can be disabled (suspended) and enabled using the global Disable button.

**Event Status** The Event Status column shows Active (currently in effect), Ready, Disabled or Test state. For more information on the Status column, see “Resetting Events” on page 210.

**Event List Commands** You can test, reset, create, duplicate, clear or delete events in the list. These commands can be performed using the on-screen buttons or by right-clicking on list items. Multiple events can be selected to test, reset, duplicate, clear or delete them, but only one new event can be created at one time.

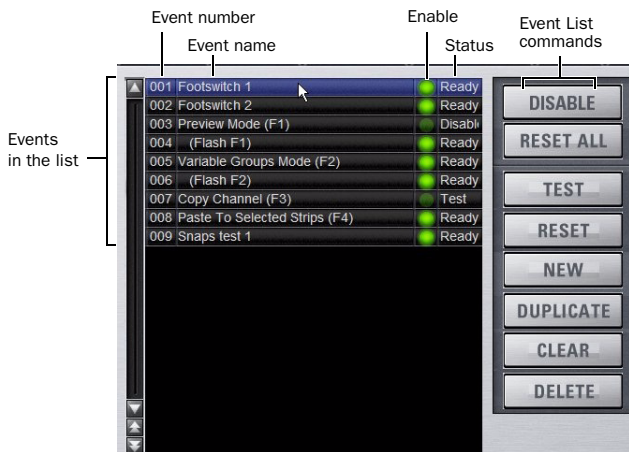

Event List items, commands and displays



## Triggers

The Triggers list shows the name and properties of each trigger defined for the currently selected event, as well as commands to create and manage triggers.



Triggers list items, commands and displays

### Triggers List

Each event can have up to eight triggers in the list. Triggers are shown in rows in the Triggers list. Right-click commands let you select, edit, duplicate and delete triggers.

### Add

The Add pop-up menu lets you create new triggers. Triggers are organized in the menu according to the type of console function or input signal that initiates (or triggers) the event. Types of triggers include channel functions, footswitch/GPI inputs, snapshot recall, and other console functions such as talkback.

### Type and Properties

Each row in the Triggers list shows the selected trigger Type. Some types of triggers have editable properties such as a dB level on a specific channel, or open/closed state of a footswitch input. Choices vary depending on the trigger type, and not all triggers have editable properties.

### Logical Operators

Multiple triggers can be considered conditionally by applying a logical operator (AND, OR, XOR) to their properties.

 *Triggers and actions which are unavailable due to unavailable hardware or console configuration are shown as italicized in the Trigger (and Action) Add menus.*

## Actions

The Actions list shows the actions defined in the currently selected event, as well as commands to create and manage actions.

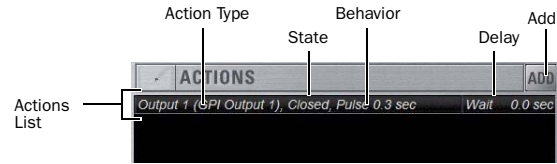

Actions list items, commands and displays

### Actions List

Each event can have up to eight actions in the Actions list. All actions occur when the event is fired. Right-click commands let you select, edit, duplicate and delete actions.

### Add

The Add pop-up menu lets you create new actions. Actions are organized in the menu according to the type of function they affect, such as channel functions, snapshots, GPI Output and Tap Tempo.

### Type and Properties

Each row in the Actions list shows the selected action Type. Some actions have editable State and Behavior settings: all actions have a Wait (Delay) setting.

### Footswitch and GPI Status

The Status display includes the Footswitch and GPI sections (see Figure 19), which show the present open or closed status of each logic port. Each footswitch or GPI port can be named.

Example uses of Switch and GPI inputs include remote snapshot recall from an external control system or custom control panel, or access to a console mode such as Preview mode, from any Function key or footswitch input.

Example uses of GPI output include the following:

- Sending a pulse to trigger samplers and playback devices
- Indicating when a microphone or channel is live by lighting an On Air or “tally” light
- Flashing or turning on a light when the console is in a particular mode (such as Solo In Place)
- Integrating with power sequencing devices for automated system turn-on

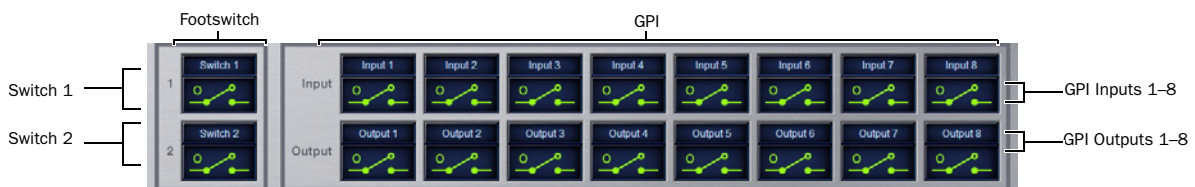

Figure 19. Footswitch and GPI Status Display in the Events window

## Creating Events

The basic steps to create an event include the following:

- Add a new event in the Event List (see “Adding an Event” on page 206).
- Add and configure triggers for the event (see “Adding Triggers to an Event” on page 207).
- Add and configure actions for the event (see “Adding Actions to an Event” on page 209).



*Several pre-defined (default) events are available immediately; others are available among the Demo Shows installed with the system software. For more information, see “Default Events” on page 212.*

## Adding an Event

**To add a new Event to the Event List:**

- 1 Go to the Options > Events page.
  - 2 Do any of the following:
    - To create an empty, untitled new event, click the New button in the Event Commands section.
- or –
- To create a copy of a pre-existing event, select one or more events in the list and click the Duplicate button.

## Selecting Events

Event list items can be selected, renamed, duplicated, deleted, cleared, enabled or disabled, tested and reset.

**To select one or more events, do any of the following:**

- To select a single event, click its row in the Event List.
- To select all events, right-click an event and choose Select All.
- To select multiple contiguous events, click the first desired event and then Shift-click (or Multi-Select-click) the last desired event. All events in between are selected.
- To select multiple discontinuous events, or to de-select an individual event, Ctrl-click (or Fine-click) its row in the Event List.



Events selected in the Event List

**To deselect or ore more events:**

- Right-click anywhere in the Event List and choose Deselect All.

## Moving Events

Selected events can be dragged and dropped to new locations in the list. You can also manually edit the Event number to re-sequence items.

**To move one or more events:**

- 1 Select one or more events in the Event List.
- 2 Click in the row of any selected event and drag to a new location in the list. As you move events, a white line appears indicating the destination.
- 3 Release the mouse button to drop the events at the desired location in the Event List. When moving multiple events, moved events will be adjacent regardless of their original locations relative to each other (whether adjacent or non-adjacent). Events will be renumbered as necessary according to the new sequence of events.

**To manually edit an Event number:**

- Double-click the Event Number and enter a new three digit number to resequence the list accordingly.

## Managing Events in the Event List

Once created, events in the list can be managed using on-screen buttons and right-click commands to rename, duplicate, delete, clear, enable or disable them.



*You can also use the Test and Reset commands to manually audition events for development and diagnostics. For more information, see “Testing Events” on page 210*

## Renaming an Event

**To rename an event:**

- 1 Double-click the Event Name in the list. Or right-click the Event Name and choose Rename.
- 2 Enter a new name.
- 3 Click Enter to confirm the new name.

## Duplicating an Event

Duplicating an event can simplify Event List configuration when multiple, similar events need to be created, each with slightly different properties.

**To duplicate an event:**

- 1 Select one or more events in the Event List.
- 2 Click the Duplicate button on-screen. Or, right-click a selected event and choose Duplicate.

## Deleting and Clearing an Event

*Deleting* an event removes it permanently from the Event List. *Clearing* an event leaves the named Event in the Event List but clears all associated triggers and actions.

### To delete an event:

- 1 Select one or more events in the Event List.
- 2 Do one of the following:
  - Click the Delete button on-screen.
  - Right-click a selected event and choose Delete.
- 3 Click Delete in the Confirm Event Operation dialog to delete the event. Or click Cancel to cancel the operation.

### To clear an event:

- 1 Select one or more events in the Event List.
- 2 Do one of the following:
  - Click the Clear button on-screen.
  - Right-click a selected event and choose Clear.
- 3 Click Clear in the Confirm Event Operation dialog to clear the event. Or click Cancel to cancel the operation.

## Enabling and Disabling Events

Events can be disabled to suspend their operation. An event can be selected and edited while it is disabled.

You can toggle the enabled state of one or more events in the list by clicking the on-screen Enable icons in the Event List, or you can disable the Event List globally by clicking the master events Disable button.

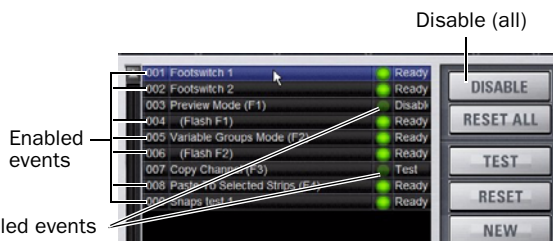

One selected event and two disabled events

### Toggling Enable Status for Selected Events

#### To toggle the enable/disable status of an event in the list:

- 1 Select one or more events in the Event List.
- 2 Click the Enable icon for the selected event to toggle its state. Or, right-click an item and choose Enable or Disable as appropriate. When the Enable icon is lit (green) the event is enabled; when the icon is unlit the event is disabled.

Disabling an active event does not automatically de-activate any associated actions configured for While Active behavior. Use the Reset command instead (see “Resetting Events” on page 210).

Disabling an event stops all delay timers (Wait properties) associated with that event, preventing any pending (delayed) actions from occurring.

 *Disabling an event can be a useful troubleshooting tool, such as when an event has caused an action/trigger feedback loop and must be edited before being re-enabled.*

## Disable All Events

The Disable button in the Events Commands section lets you temporarily disable all events in the event list.

### To disable all Events:

- Click the on-screen Disable button in the Events Commands area. The Disable button lights, and all items in the Event List show “Disabled” in the Status column.

### To re-enable Events:

- Click the Disable button again.

All Events are prevented from firing when the global Disable function is in effect. However, active events are not de-activated. Use Reset or Reset All for this (see “Resetting Events” on page 210).

Individual Event enable/disable status is preserved (events retain the current state of their Enable icons) and can be modified when globally disabling and enabling events using the master Disable button.

Disabling an event stops all timers (Wait/delay properties) associated with that event, preventing any pending (delayed) actions configured for While Active behavior from occurring.

## Creating Triggers

Each event can have up to eight triggers. You create new triggers by selecting them from the Add pop-up menu. Once added, you can edit triggers and their properties to customize them.

## Adding Triggers to an Event

### To add a trigger:

- 1 Select an event in the Event List, or create a new one. (For details, see “Selecting Events” on page 206, and “Creating Events” on page 206.)

2 Click the ADD pop-up menu in the Trigger list and select an action type. The selected trigger type is added to the Trigger list for the currently selected event, with its default properties.

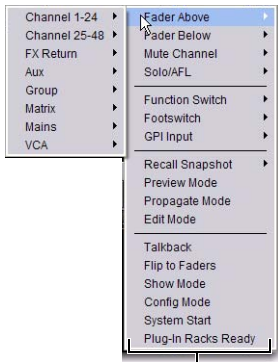

Trigger Types

**Add Triggers**

For a list of available trigger types, see “Trigger Types” on page 215.

**Editing Trigger Type and Properties**

**To edit the trigger and its properties:**

- 1 Double-click the trigger row in the list. Or right-click the action item and choose Edit.
- 2 Choose a new Trigger Type, or edit any of the available properties in the row for that trigger. Properties vary depending on the type of trigger selected (not all trigger types have editable properties).

**Logical Operators for Triggers**

An individual trigger is considered to be “true” when the function described by its type and properties takes place, such as while a footswitch is actually pressed, or a fader is raised above its trigger threshold.

A trigger is considered to be “false” (or, not occurring) whenever its function and properties are not met, such as when a footswitch is not being pressed, or while a fader remains below its assigned trigger threshold.

When an event includes multiple triggers, a logical operator (OR, AND, XOR) must be chosen from the Operators pop-up menu. (The default Operator is OR.)

The logical operator has no effect when the Triggers list includes only one item.

**To choose a logical operator for the current event:**

- 1 Select the desired event to display its assigned triggers.
- 2 Click the Operators pop-up menu (by default, this pop-up menu displays “OR”) and choose AND, OR, or XOR.

Only one logical operator is permitted per event, and this operator applies to all triggers within the event. It is not possible to use a mix of logical operators within an event.

**Examples of Logical Operators**

Logical operators determine the precise state required in order for an event to occur as shown in the following tables:

**OR** At least one of the triggers must be true. The following table shows the effect of OR on events with multiple triggers. In the table, 0 indicates a false condition (not occurring) and 1 indicates a true condition (occurring).

*Example truth table for OR, showing two triggers*

Trigger A	Operator	Trigger B	Result
0	OR	0	0
0	OR	1	1
1	OR	0	1
1	OR	1	1

When using OR, if one or more (but not all) of the triggers go false, the event logic is only acted on again when all triggers evaluate to false (result = 0).

**AND** All triggers must be true. The following table shows the effect of AND on events with multiple triggers. In the table, 0 indicates a false condition (not occurring) and 1 indicates a true condition (occurring).

*Example Truth table for AND showing two triggers*

Trigger A	Operator	Trigger B	Result
0	AND	0	0
0	AND	1	0
1	AND	0	0
1	AND	1	1

**XOR**

At least one trigger, but not all, must be true. The following table shows the effect of XOR on events with multiple triggers. In the table, 0 indicates a false trigger condition (not occurring) and 1 indicates a true condition (occurring).

*Example Truth table for XOR showing two triggers*

Trigger A	Operator	Trigger B	Result
0	XOR	0	0
0	XOR	1	1
1	XOR	0	1
1	XOR	1	0

## Managing Triggers in the Triggers List

Triggers in the list can be edited, duplicated and deleted.

### Editing Triggers

**To edit a trigger:**

- 1 Double-click the trigger in the Triggers List. Or, right-click the item in the list and choose Edit.

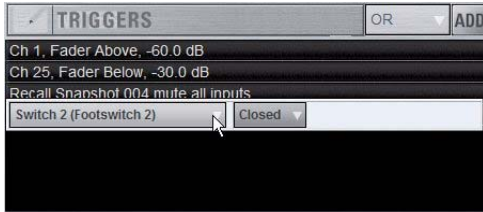

**Editing a trigger**

- 2 Do any of the following:
  - To change the trigger type, click the Type pop-up menu and make a new selection from the Type menu.
  - For Fader Above or Fader Below triggers, click the currently displayed dB value to highlight it, then type in a new value.
  - For switches, buttons and other two-state functions, click the State pop-up menu and make a selection. Choices for State vary as appropriate for the trigger type, and will include Closed or Open, On or Off, and Pressed or Released.
- 3 To confirm your changes, press Enter or click anywhere else in the Events window.

### Selecting Triggers

Triggers can be selected using the same methods as used when selecting items in the Event List. For more information, see “Selecting Events” on page 206.

### Duplicating Triggers

**To duplicate a trigger:**

- 1 Select one or more items in the Triggers List.
- 2 Right-click on any selected item and choose Duplicate.

### Deleting Triggers

**To delete a trigger:**

- 1 Select one or more items in the Triggers List.
- 2 Right-click on any selected item and choose Delete.

## Creating Actions

Each event can have up to eight actions. You create new actions by selecting them from the Add pop-up menu. Once added, you can customize actions by editing their properties, as available.

### Adding Actions to an Event

**To add an action:**

- 1 Select an event, or create a new one.
- 2 Click the ADD pop-up menu in the Action list and select an action type. The selected action type, with its default settings, is added to the action list area.

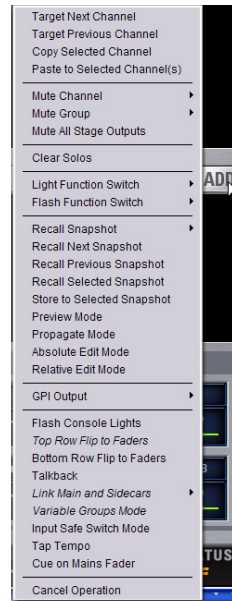

**Add Actions**

 For a list of available actions, see “Action Types” on page 216.

### Editing an Action Type and Properties

**To edit an action:**

- 1 Double-click the action row in the list. Or, right-click the action item and choose Edit.
- 2 Click the displayed action Type and make a new selection.

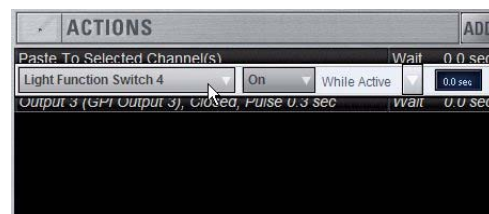

**Editing an action**

## Action State

**To edit an action State for switches, buttons and other two-state functions:**

- Click the State pop-up menu and make a selection. Choices for State vary as appropriate for the trigger type, and will include Closed or Open, On or Off, and Toggle.

## Action Behavior

**To edit action behavior:**

- Click the Behavior pop-up menu and choose Latch or While Active, as appropriate:

**Latch** Fixes the behavior in its defined state (such as open or closed) until unlatched by another event or operation.

**While Active** Latches the behavior in its defined state as long the associated trigger is in effect (active, or “true”), such as unmuting a channel only while a footswitch is pressed and held.

**Pulse and Duration (GPI Output only)** Produces a single-shot pulse output. Duration range is 0.1 second (100 ms) to 1.0 second, in 0.1 second increments. The default duration is 0.3 seconds (300 ms).

**To configure GPI output pulse and duration for an action:**

- Double-click the action to edit it
- Click the Behavior selector and choose Pulse.
- Enter a value for Pulse Duration.
- To confirm you changes, press Enter or click anywhere else in the Events window.

## Action Wait

All actions let you specify a Wait time of up to 100 seconds for the action to wait before firing. This can be useful for synchronizing the timing of multiple external devices, or to build timed sequences of actions.

**To configure action Wait (Delay):**

- Double-click the action to edit it.
- To confirm your changes, click the Wait value to highlight it, then type in a new value.

## Selecting Actions

Actions can be selected using the same methods as used when selecting items in the Event List. For more information, see “Selecting Events” on page 206.

## Managing Actions in the List

Actions can be moved, renamed, duplicated, and deleted by right-clicking them and choosing the desired operation, just as you can with triggers. For instructions on managing items in the Actions List, follow the instructions for triggers in “Managing Triggers in the Triggers List” on page 209.

---

## Testing Events

An event can be manually triggered to test it, regardless of its current Event Status or enabled/disabled state. Use this feature to verify action properties and confirm proper operation of devices connected to GPI output ports.

When an event is in Test mode, it is effectively considered true until the event is manually reset. An Event in test can be re-tested at any time by again pressing the Test button. You do not have to reset in-Test events to re-test them.

Incoming triggers are ignored when events are in Test mode. For example, if a footswitch event is being tested and you accidentally hit the footswitch at some point during the test, the event does not revert to Active the moment Test is cancelled.

Events always return to their ready state following a Reset. Events won't re-fire until the trigger logic re-asserts itself as true.

**To test events:**

- Select one or more events in the Event List.
- Click the Test button. Or, right-click an event and choose Test from the pop-up menu.
- When you're satisfied the event is behaving correctly, click the Reset button. Or, Right-click an event and choose Reset.

---

## Resetting Events

You can use the Reset features to quickly reset Active or in-Test events to “ready.” You can also use the Reset All command (in the Events Commands buttons) to immediately reset all events in the list.

The current status of each event is shown in the Status column in the Event List:

*Event List Status indicators*

Status	Description
Active	Event is currently true (triggered)
Ready	Event is currently false (not triggered)
Disabled	Event is disabled and can not be triggered
Test	Event has been manually triggered



### To reset an event:

- 1 Select one or more events in the Event List. (See “Selecting Events” on page 206.)
- 2 Click the Reset button. Or, right-click an event and choose Reset to reset an Active or in-Test event back to a Ready state.

### To reset all events:

- Click the Reset All button.

### When events are reset, the following rules are applied:

- ◆ Latching or pulsed actions which have already occurred are unaffected. For example, reset doesn’t unlatch a previously latched function.
- ◆ All action delay timers (Wait) are immediately cancelled.
- ◆ Actions configured for While Active behavior are immediately cancelled.
- ◆ Events will not occur until the trigger logic again evaluates as true.

For example, let’s say you have an event configured to close a GPI Output whenever Channel 3 is muted (its behavior property is While Active). Resetting the event opens the GPI Output, even though the Channel 3 might still be muted. The event will re-trigger the next time the channel goes from an unmuted state to a muted state.

---

## Snapshots and Events

Events can include snapshot functions among their triggers and actions.

### Snapshots as Triggers

Events can be triggered by the following snapshot functions:

- Recall of specific snapshots
- Enabling of Snapshot modes (Preview, Propagate and Edit)

### Snapshots as Actions

Event actions can include the following snapshot functions:

- Recall of a specific snapshot
- Recall the previous, next or selected snapshot.
- Initiate Store to Selected Snapshot commands (overwriting and updating snapshots)
- Enable different Snapshot modes (Preview, Propagate and Edit)

## Snapshot Modes and Event Status

While in Propagate or Edit modes, events-driven snapshot recall is suspended.

While in Preview mode, triggers that occur in the online state of the console are executed, including MTC-driven recall of snapshots. Triggers caused by changes to the offline (Preview) controls are ignored and do not cause events to occur.

## Avoid Feedback Loops

Because events can both affect and be affected by snapshots, it is possible for events to cause “feedback loops.”

Be especially careful when Recall Previous or Next snapshot triggers and actions are combined with events that recall a specific snapshot, as shown in the following diagram.

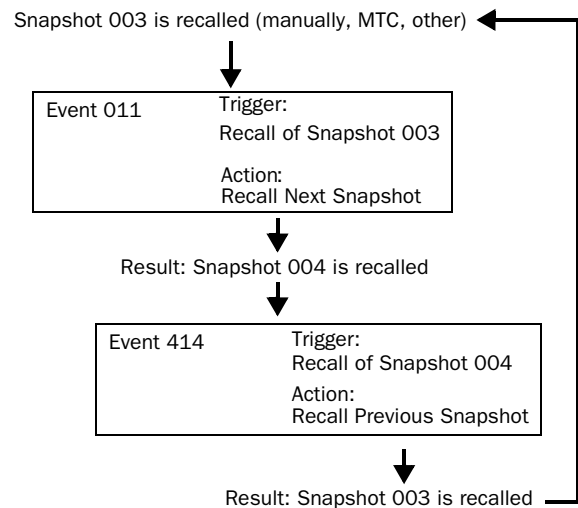

Diagram illustrating potential logic feedback loop between events and snapshots

💡 The global Event Disable and Reset All buttons can serve as “panic” buttons to temporarily suspend and/or reset all events, giving you a chance to diagnose the source of the problem. For more information, see “Resetting Events” on page 210.



## Default Settings, Templates and Examples

### Default Events

The following pre-defined events are included for you to use as examples and as the starting point for your own events.

#### Default events

Event Number	Type and Name	Triggers	Actions
001	Footswitch 1	Switch 1 (Footswitch 1) Closed	<i>undefined</i> (choose an action)
002	Footswitch 2	Switch 2 (Footswitch 2) Closed	<i>undefined</i> (choose an action)
003	Preview Mode (F1)	Function Switch 1, Pressed	Preview mode, Toggle, Latch
004	(Flash F1)	Preview Mode, On	Flash Function Switch 1, On, While Active
006	(Flash F2)	Variable Groups Mode, On	Flash Function Switch 2, On, While Active
007	Copy Channel (F3)	Function Switch 3, Pressed	Copy Selected Channel Light Function Switch 3, On, While Active
008	Paste to Selected Strip (F4)	Function Switch 4, Pressed	Paste to Selected Channel(s) Light Function Switch 4, On, While Active
009	Tap Tempo	Function Switch 8, Pressed	Tap to define system tempo for delay plug-ins that support Tempo Sync

### Templates

The following table provides a listing of common event definitions. Use the techniques explained throughout this chapter to add one or more of the following events to establish your own set of events, triggers and actions.

#### Suggested event definitions for common functions

Event Name	Trigger Type	Trigger Properties		Action Type	Action Properties		Behavior
Talkback (Toggle)	Footswitch 1		Closed	Talkback		Toggle	Latch
Talkback (Momentary)	Footswitch 1		Closed	Talkback		On	While Active
Fader Start	Fader Above	Ch 1	-60 dB	GPI Output 1		Closed	Pulse (0.3 s)
Fader Stop	Fader Below	Ch 1	-inf dB	GPI Output 1		Closed	Pulse (0.3 s)
Fader Start/Stop	Fader Above	Ch 1	-60 dB	GPI Output 1		Closed	While Active
Mute Channel (Toggle)	Footswitch 1	1	Closed	Mute	Ch 1	Toggle	
Mute Channel (Momentary)	Footswitch 1	1	Closed	Mute	Ch 1	On	While Active
Toggle Input Safe Switch mode	Function Switch 1		Pressed	Input Safe Switch Mode			
Tap Tempo	Function Switch 1		Pressed	Tap Tempo			
Cue on Mains	Function Switch 1		Pressed	Cue on Mains			

## Using the Templates

To add any of the Events listed in the table, do the following (using the first template, Talkback (Toggle) as an example):

### To use the templates:

- 1 Create a new event.
- 2 Edit the event name (for example, “Talkback (Toggle)” as shown in the table). For renaming instructions, see “Renaming an Event” on page 206.
- 3 Click the (Trigger) Add pop-up menu and choose Footswitch > Switch 1 (Footswitch 1). The Switch 1 trigger type is added, with a default State setting of Closed.
- 4 Click the (Action) Add pop-up menu and choose Talkback. The Talkback action is added. By default, the action State is Toggle, and the behavior is Latched. There is no Wait (delay before firing) needed for this action.

Switch 1 (Footswitch 1) is now configured to toggle Talkback On or Off each time the footswitch is pressed.

### If you prefer momentary talkback, edit the event by doing the following.

- 1 Double-click the Talkback action in the Actions list to access its editable properties. Or, right-click the action and choose Edit.

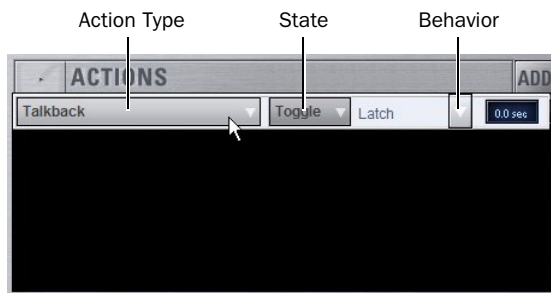

An action and its properties ready to be edited.

- 2 Click the action State pop-up menu (it displays Toggle by default, or the current State setting) and select On.
- 3 Click the action Behavior pop-up menu and select While Active. Together with the State setting (On), While Active establishes momentary control of the action; in this example, Footswitch 1 is now assigned to provide momentary Talkback control.



Talkback State and Behavior after editing

- 4 To quickly test the switch trigger, click the Test button, or press the Footswitch. Adjust the trigger State for your footswitch, as necessary, for its open/closed orientation. (For instructions, see “Editing Trigger Type and Properties” on page 208.)

- 5 After testing the trigger, click Reset to return the event to its Ready state.

## Tap Tempo for Plug-ins

Tap Tempo lets you quickly establish a system tempo to use as a beat clock for delay and echo plug-ins that support Tempo Sync.

The system tempo defaults to 120 BPM (beats per minute). You can set a custom tempo in a number of ways including by tapping a Function switch, Footswitch or other control as explained below. The system tempo is stored as a console setting within the Show file.

Snapshots can also store and recall tempo.

 A preconfigured Event for tap tempo is installed in the Demo Shows folder when you install VENUE software. To use the example Event, go to the Filing page and click the Load tab, then select the file Tap Tempo Examples and click the Load button.

## Using Tap Tempo

Do the following three steps to start using Tap Tempo:

### Enable the System Tempo

- 1 Go to the Options > Misc page, locate the Tap Tempo section and do the following:
  - Turn on the global tempo sync by clicking the On switch directly below the encoder so that it is lit (on).
  - If desired, use the encoder to set a system tempo value, or type a value directly into the Tempo field.
  - If desired, click the Units selector to choose Beats Per Minute (BPM) or Milliseconds as the units for displayed values.



Tap Tempo settings

## Create a Tap Tempo Event

2 Go to the Options > Events page and do the following in the order presented:

- Create a new Event and call it Tap Tempo.
- Click the Add button in the Trigger area, and select an available Function switch (F switch) or Footswitch.
- Click the Add button in the Action section, and choose Tap Tempo.

## Enable the Plug-in's Tempo Sync and Start Tapping

Next, navigate to a delay plug-in and enable its Tempo Sync switch. Repeat for other delay plug-ins you want to sync.



Tempo Sync



## Tempo Sync in ModDelay and Line6 Echo Farm

3 Tap the assigned Tap Tempo trigger (Function switch or Footswitch) in time with the music. At least two taps are needed to set the tempo; additional taps can result in a more accurate tempo setting.

The delay time of all Tempo Sync-enabled plug-ins change to match the system tempo. While tapping, the calculated tempo is also shown in the Status area of the screen.

## Tips for Using Tap Tempo

The plug-in Tempo Sync switch enables/disables that individual plug-in's delay value from following the system tempo. Use the individual plug-in Tempo Sync switches to sync one, some or all delay plug-ins.

Tempos can range from 20 BPM (3,000 ms) to 300 BPM (200 ms). Some delay plug-ins offer different time divisions (such as 1/8th, 16th, or dotted) that you can select for variations based on the system tempo. Check your delay plug-ins to see if they support Tempo Sync and subdivision settings (most, but not all, do).

## Snapshots and Tempo Sync

If you need a specific delay time every time a certain snapshot is recalled, store Tempo with snapshots. For details, see "Adding Tempo Data to Snapshots" on page 196.

## Trigger Types

The following table lists the available trigger types and properties, along with a description of each.

**Table 23. Trigger List, with default settings**

Trigger Type	Property 1	Property 2	Description
Fader Above	Channel name/number	Fader level –inf to +12 dB (Default: –60 dB)	Fader moved above threshold level
Fader Below	Channel name/number	Fader level –inf to +12 dB (Default: –inf)	Fader moved below threshold level
Mute	Channel name/number	On (default) Off	Mute active/inactive
Solo/AFL	Any input, output, VCA, Solo In Place	On (default) Off	Solo/AFL active/inactive
Function Switch	Function Switch 1–8	Press (default) Release	On button press (down) On button release (up)
Footswitch	Footswitch 1, 2	Open Closed (default)	Footswitch input high Footswitch input low
GPI Input	GPI input 1–2	Open Closed (default)	GPI Input high GPI Input low
Recall Snapshot	Snapshot number and name		Event triggered by snapshot
Preview Mode		On (default) Off	Preview Mode active/inactive
Propagate Mode		On (default) Off	Propagate Mode active/inactive
Edit Mode		On (default) Off	Edit Mode active/inactive
Talkback		On (default) Off	Talkback active/inactive
Flip to Faders		On (default) Off	Flip to Faders active/inactive
Show Mode			Console Show Mode is active
Config Mode			Console Config Mode is active
System Start			System software initialized
Plug-In Rack Ready			Mirrors plug-ins rack Ready state

## Action Types

The following table lists the available Action types and properties, along with a description of each.

Table 24. Action types

Action Type	Property	State	Behavior	Description
Target Next Channel				Selected Channel advances by one
Target Previous Channel				Selected Channel reverses by one
Copy Selected Channel				Channel copy operation
Paste to Selected Channel(s)				Channel paste operation
Mute Channel	Channel name/number	On Off Toggle (default)	Latch (default) While Active	Mute selected channel
Mute Group	Mute Group 1–8	On Off Toggle (default)	Latch (default) While Active	Toggle Mute group status
Mute All Stage Outputs		On Off Toggle (default)	Latch (default) While Active	Mute all stage outputs
Clear Solos				Mirrors console Solo Clear
Light Function Switch	1–8	On (default) Off Toggle	Latch While Active (default)	Lights Function switch
Flash Function Switch	1–8	On (default) Off Toggle	Latch While Active (default)	Flashes Function switch
Recall Snapshot	Snapshot number and name			Recall specified snapshot
Recall Next Snapshot				Mirrors Snapshot Next switch
Recall Previous Snapshot				Mirrors Snapshot Previous switch
Recall Selected Snapshots				Mirrors Snapshot Recall switch
Store to Selected Snapshot				Mirrors Snapshot Store switch
Preview Mode		On Off Toggle (default)		Activate/deactivate Preview Mode
Propagate Mode		On Off Toggle		Propagate mode active while trigger is true
Absolute Edit Mode		On Off Toggle (default)		Enters Edit mode when trigger is true; exits via Absolute when trigger goes false
Relative Edit Mode		On Off Toggle (default)		Enters Edit mode when trigger is true; exits via Relative when trigger goes false

Table 24. Action types

Action Type	Property	State	Behavior	Description
GPI Output	1–2	Open Closed (default) Toggle	Pulse, 0.3s (default) Latch While Active	Pulses or latches selected GPI Output
Flash Console Lights				Flashes console lights
Top Row Flip to Faders (D-Show Main only)		On Off Toggle (default)	Latch (default) While Active	Mirrors top encoder row Flip to Faders
Bottom Row Flip to Faders		On Off Toggle (default)	Latch (default) While Active	Mirrors bottom encoder row Flip to Faders (D-Show Main only)
Link Main and Sidecar(s) (D-Show Main only)	Faders Encoders Both	On Off Toggle (default)	Latch (default) While Active	Mirrors console function
Variable Groups Mode (VENUE Profile and D-Show only)		On Off Toggle (default)	Latch (default) While Active	Toggles Variable Groups Mode on/off (only if console config is 24-bus mode)
Input Safe Switch Mode				Cycles through Input Safe Switch modes
Tap Tempo				Sets the system tempo to synchronize delay plug-ins that support Tempo Sync
Cue on Mains				Maps Cue level (Solo/Monitor bus) level to the Mains fader; maps Mains to Output encoders 1–3
Cancel Operation				Mirrors console Cancel switch (and Esc key on keyboard)





# Chapter 23: Synchronization

VENUE systems provide a set of MIDI-based synchronization features that allow automation and remote control of snapshots, and triggering of external devices when snapshots are recalled.

## Automating Recall of Snapshots with MIDI Time Code

You can automate the recall of snapshots with MIDI Time Code (MTC). The VENUE system can trigger snapshots with internally generated MIDI Time Code, or it can read MIDI Time Code from an external source.

 For instructions on MIDI and other connections required for synchronization, see Chapter 2, “Configuring and Connecting Profile.”

## Generating MIDI Time Code

You can set the VENUE system to generate MIDI Time Code and automate the recall of snapshots based on MTC playback.

**To generate MIDI Time Code from the VENUE system:**

- 1 Go to the Options page and click the Snapshots tab.
- 2 Under MTC Mode, click Generate. MIDI Time Code generator controls appear at the bottom of the screen.

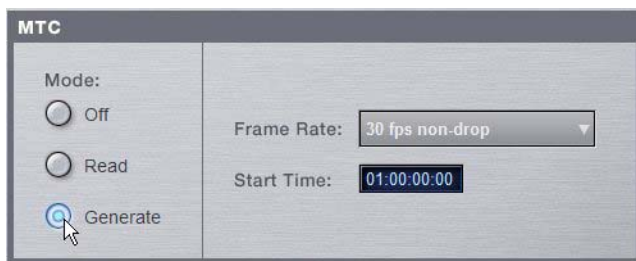

Setting the MIDI Time Code Mode

- 3 Choose the MTC Frame Rate from the Frame Rate pop-up menu (24 fps, 25 fps, 30 fps drop, or 30 fps non-drop).
- 4 If you want MTC playback to start at a different time than the currently displayed time, enter a start time in the Start Time field, and press Enter.

5 Control MTC playback from the MTC generator controls by doing any of the following:

- Start MTC playback by clicking the Play button.
- Pause MTC playback by clicking the Pause button.
- Stop MTC playback and reset to the Start Time by pressing the Stop button.



MIDI Time Code controls

## Reading External MIDI Time Code

The VENUE system can slave to external MTC and automate the recall of snapshots based on the incoming MTC.

**To read external MIDI Time Code:**

- 1 Go to the Options page and click the Snapshots tab.
- 2 Under MTC Mode, click Read. A MIDI Time Code display appears at the bottom of the screen.



MIDI Time Code display

VENUE automatically detects the frame rate of the incoming time code (24 fps, 25 fps, 30 fps drop, or 30 fps non-drop).

The MIDI Time Code display indicates the following:

- When MIDI Time Code is not present, the display shows a series of dashes.
- When MIDI Time Code is present, the current time code value is shown in green.

## Snapshot MIDI Time Code Display

When the system is set to generate or read MIDI Time Code, the Snapshots List shows time code values and a green Recall Enable indicator for each snapshot entry.



001	*Instructions1(seNots)*	01:00:00:00	🟢
002	* Instructions 2 *	01:00:05:00	🟢
003	All Plug-Ins sync'ed	01:00:10:00	🟢
004	No plug-ins sync'ed	01:00:15:00	🟡
005	One plug-in sync'ed	01:00:20:00	🟢
006	Two plug-ins sync'ed	01:00:23:00	🟢
007	-----	01:00:25:00	🟢
008	Reset Demo	01:02:00:00	🟢

Snapshots List showing time code values and indicators

## Assigning Time Code Values to Snapshots

With the VENUE system set to generate or read MIDI Time Code, you can assign time code values to snapshots by entering values manually, or by capturing MTC playback values.

### Manually Assigning Time Code Values to Snapshots

To manually assign an MTC value to a snapshot:

- 1 In the Snapshots List, double-click the MTC value you want to change.



003	Snap 003	01:00:11:19
004	Snap 004	01:00:20:15
005	Snap 005	01:00:23:19
006	Snap 006	01:00:29:23
007	Snap 007	01:00:35:08

Snapshot showing selected MTC value

- 2 Do one of the following:
  - From the keyboard, type a new MTC value.
  - or –
  - Press the Left and Right Arrow keys to move the cursor between number fields, and the Up and Down Arrow keys to increase and decrease the selected value.
- 3 Press Enter or click another snapshot MTC value to accept the entry.

## Capturing Time Code Values in Snapshots

To capture the current MTC value in a new snapshot:

- 1 With the system in MTC Read or Generate mode, start time code playback.
- 2 Do one of the following:
  - During playback, click the New button.
  - or –
  - Pause playback at the time code value you want to capture, and click the New button.

A new snapshot appears with the time code value at the time of creation.

To capture the current MTC value in an existing snapshot:

- Right-click the snapshot in the Snapshots list and choose Set Timecode To.

The time code value is updated to the currently displayed value.

## Sorting Snapshots by Time Code Value

You can sort snapshots in the Snapshots list by Time Code value, so that they appear in chronological order.

 When chasing to MTC, snapshots will always recall in chronological order, regardless of their order in the Snapshots list.

To sort snapshots by their assigned MIDI Time Code value:

- Right-click any snapshot in the Snapshots list and choose Re-Sort All By Time Code.

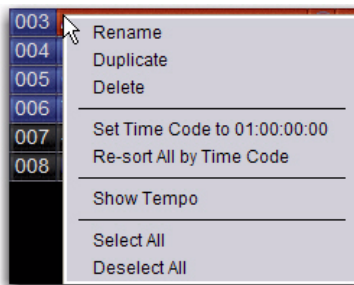

Right-click menu for items in the Snapshots list

## Enabling Snapshots for Automated Recall

With time code values assigned to snapshots, you can then enable snapshots for recall with time code playback.

### To enable snapshots for automated recall with MTC:

- Click the Time Code Recall Enable indicator on the right side of the Snapshots list. The indicator turns bright green to indicate that the snapshot is enabled for recall.



Snapshot enabled for automated recall with MTC

## Chasing MIDI Time Code

With snapshots enabled for automated recall, the Chase MTC function needs to be engaged to allow automated recall to occur.

### To initiate automated recall of snapshots:

- Click the Chase MTC button so that it is highlighted.
- Begin MTC playback by starting the internal generator (if set to MTC Generate) or the external device (if set to MTC Read).

When a recall-enabled snapshot's time code value is reached, the snapshot is recalled.

 Snapshot modes can affect MTC recall. For more information, see "MTC and Other Online Event Triggers" on page 194.

The Chase MTC button can be used to quickly take VENUE system offline from MTC-triggered recall in performance in the event of a change in timing, such as a missed cue or dropped verse. You can then advance manually to an appropriate snapshot, and re-enable Chase MTC.

 VENUE systems do not chase up to the current timecode value. If you start playback in the middle of a snapshot sequence, any prior snapshots will need to be recalled manually to update the console before beginning time code playback. For more information, see "Selecting and Recalling Multiple Snapshots" on page 184.

## Remote Control of Snapshot Recall

The VENUE system can be set to recall snapshots in response to MIDI control messages sent from an external device such as an AV controller system. You can set the system to respond to control messages sent on any one of 16 available MIDI channels.

Snapshots are recalled when their snapshot number (1–999) is received in the form of MIDI Bank Select and Program Change messages. (See Table 24 on page 221.)

### To enable recall of snapshots from an external device:

- Go to the Options page and click the Snapshots tab.
- Under MIDI, select the Snapshots Respond to Channel option, and choose the MIDI channel from the corresponding pop-up menu.



Snapshot MIDI respond option

The system listens on the specified channel for Bank Select and Program Change messages.



 The MIDI Snapshot Output Safe option does not affect this option. You can only turn off this feature by deselecting the "Snapshots Respond to Channel" option.

Table 24. MIDI Bank and Program Numbers for Snapshots

Bank	Program	Snapshot Number
0	0–127	001–128
1	0–127	129–256
2	0–127	257–384
3	0–127	385–512
4	0–127	513–640
5	0–127	641–768
6	0–127	769–896
7	0–103	897–999

 VENUE software stores Bank Select messages, so it is not necessary to send a Bank Select message prior to every Program Change message. You only need to send a Bank Select message when you want to recall a snapshot in a different bank from the previous snapshot.

---

## Triggering of External Devices on Snapshot Recall

The VENUE system can be set to send MIDI Bank and Program Change messages whenever a snapshot is recalled, to trigger external devices whose cues are related to snapshots. You can set the system to send on any one of 16 available MIDI channels.

 *MIDI output is automatically suspended while in Preview mode. For more information, see “Preview Mode” on page 191.*

While it is possible to add Bank Select and Program Change messages to individual snapshots, this option lets you toggle messages on and off for all snapshots in one step. Using this option also ensures that the Bank Select and Program Change messages correspond to the snapshot number, even after snapshots are rearranged in the Snapshots list.

The Bank Select and Program Changes messages reflect the number (1–999) of the recalled snapshot. (See Table 24 on page 221.)

 *VENUE systems always send a Bank Select message before every Program Change message, even if the bank number has not changed from the previous snapshot.*

**To enable triggering of external devices when snapshots are recalled:**

- 1 Go to the Options page and click the Snapshots tab.
- 2 Under MIDI, select the Snapshots Send on Channel option, and choose the MIDI channel from the corresponding pop-up menu.



**Snapshot MIDI send option**

The VENUE system sends a Bank Select and Program Change message on the specified channel whenever a snapshot is recalled.

 *The MIDI Snapshot Output Safe command does not affect the option to send on specific MIDI channels. You can only turn off this feature by deselecting the “Snapshots Send on Channel” option.*

---

## Sending MIDI Messages on Snapshot Recall

You can add up to 20 specific MIDI messages to each snapshot. These messages are sent whenever the snapshot is recalled. Sending of the messages is enabled with the MIDI scope control in the Snapshots window. For more information, see Chapter 21, “Snapshots.”

---

## Synchronizing with Word Clock and Digital Audio Input

VENUE systems receive and output Word Clock (at a sample rate of 48 kHz ± 10ppm) for synchronization with a master clock generator (house sync) or other device that uses clock reference. VENUE systems can operate as a Word Clock master, or it can slave to Word Clock input.

The Word Clock In and Word Clock Out ports are located on the Mix Rack and FOH Rack.

## Synchronizing with Digital Audio Input

VENUE systems automatically synchronize to Word Clock In. All digital inputs are sample rate converted and clocked to 48k and synchronized to the VENUE system clock.

This lets you connect a variety of digital sources (such as a DAT machine or CD player with digital outputs), directly to VENUE digital inputs.

For instructions on Word Clock and digital audio connections for synchronization, see Chapter 2, “Configuring and Connecting Profile.”

# Chapter 24: Using the Standalone Software

VENUE Standalone software lets you do all of the following to preconfigure performances, wherever you can use your laptop:

- Learn the basics of the VENUE software interface in preparation for working at a full VENUE system.
- Assign hardware I/O and routing, and name channels.
- Set channel input, EQ, dynamics, pan, and other settings.
- Create and maintain a library of setups, with access to nearly all parameters available on the control surface.
- Store and recall Snapshots, and configure Events.
- Use the Filing features to transfer Shows, Shows Folders, and plug-in presets to/from a compatible USB storage device to transfer data between the standalone software and VENUE.

 *Transferring data must be done to/from a compatible USB storage device such as a USB key disk or other external USB hard drive.*

## Differences Between Standalone Software and a VENUE System

The Standalone software is nearly identical to that on a full VENUE system, with the following differences:

### Audio Throughput

You cannot play audio through the Standalone software. Real-time audio requires the VENUE hardware.

### Plug-In Editing

When a Show is transferred from a complete VENUE system, all plug-ins installed on the D-Show system are visible in the Standalone software as *offline* (unavailable) plug-ins. You can assign offline plug-ins to racks, and assign plug-in rack routing in the Standalone software, and save the routing in snapshots.

 *You cannot install plug-ins or adjust plug-in parameters unless you are working on the complete VENUE system.*

### Hardware Configuration

In the Standalone software, you can simulate the hardware configuration of a destination system from the Devices tab of the Options page.

---

## System Requirements

The following are the minimum system requirements for using the VENUE Standalone software:

- Computer running Windows XP Pro or XP Home Edition O/S, Service Pack 1
- Minimum 1024 x 768 screen resolution
- Minimum 16-bit color graphics, 32-bit recommended
- Minimum 256 MB RAM, 512 MB recommended
- Minimum 200 MB of available hard disk space, 512 MB recommended
- CD-ROM drive for installation (unless installing from web-download)
- Available USB 1.1 or 2.0 port and compatible USB storage device (such as a flash disk, key disk or other external hard drive) for file transfer

Installation requires Windows Administrator permissions. Once installed, the software can be run under Admin or User accounts.

---

## Installing the Standalone Software

**To install the VENUE Standalone software:**

- 1 Do one of the following:
  - Download the VENUE Standalone Software Installer from the Avid website ([www.avid.com](http://www.avid.com)).
  - or –
  - Insert your VENUE Software Installer into the CD-ROM drive on your Windows XP-compatible computer.
- 2 Launch the installer and follow the instructions on-screen. The VENUE Standalone software requires no authorization.

## Removing the Standalone Software

**To remove the VENUE Standalone software:**

- 1 Launch the Add/Remove Programs Control Panel.
- 2 Choose VENUE, then follow the instructions on-screen.



## Simulating a VENUE Configuration

You can use the Standalone software to simulate a VENUE system with any number of input and outputs. The corresponding inputs and outputs become available in the Patchbay, allowing you to prepare a show that can transfer directly to the destination system.

### To simulate a VENUE system:

- 1 Launch the Standalone software.
- 2 Go to the Options page and click the Devices tab.
- 3 Right-click the console graphic and choose the type of console you will be working with.
- 4 Right-click an I/O graphic and choose the type of I/O (as available) and specify the number of Input and Output cards on the destination system.

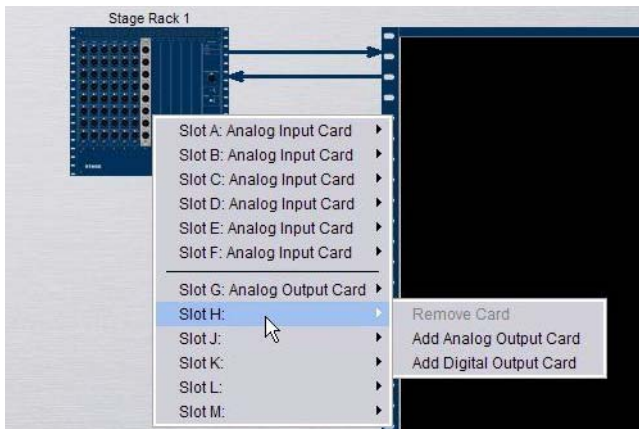

Adding Stage Rack inputs and outputs

## Transfer and Filing Quick Start

The basic steps for using the Standalone software and data transfer are as follows:

- Save data to disk, then transfer it to an external USB storage device.
- Transfer data from the USB device, then load the data.

 For complete instructions on transferring data, see Chapter 20, “Shows and File Management.”

## Save and Transfer Data from a VENUE System

### To save and transfer data from the complete system:

- 1 Connect a USB storage device to a VENUE USB port.
- 2 Use the Save tab of the Filing page to save VENUE data to disk.
- 3 Go to the Filing page and click the Transfer tab.
- 4 Do one of the following to select the type of data to transfer:
  - To transfer all data, click the Console icon.
  - To transfer Console Settings (the current state of the console, equivalent to an auto-saved Show file), click the Settings icon.
  - To transfer Show Folders, click the Show Folders icon.
  - To transfer individual Shows, click the Shows icon.
  - To transfer Preset Folders, click the Preset Folders icon.
  - To transfer Presets for individual items, click the Built-In icon or the Plug-In icon and choose a processor, plug-in or Input Channel Presets item from the pop-up menu, or click the Scope Sets icon.
- 5 In the left column, select the items you want to transfer from VENUE to the portable storage device.



Transferring Show files from VENUE

- 6 Click the Transfer button.

## Transfer and Load Data to the Standalone Software

- 1 Connect the USB storage device to your laptop. Make sure the drive is mounted before proceeding.
- 2 Launch the VENUE standalone software.
- 3 Go to the Filing page and click the Transfer tab.
- 4 Make sure your USB disk is available in the list at right.
- 5 Click the Console, Settings, Show Folders, Shows, Preset Folders, Built-In, Plug-In or Scope Set selectors to select the type of data you want to transfer.

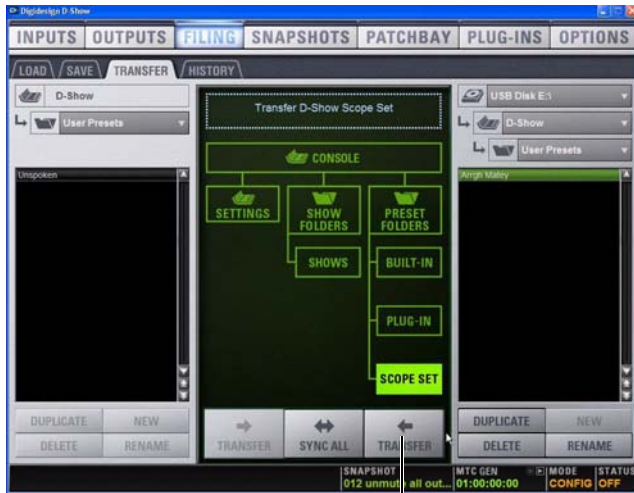

Click

### Transferring a Scope Set for the standalone software

- 6 Click the Transfer button. The data is transferred from the USB device to the appropriate VENUE data folders on the laptop.
- 7 If you chose Console, data is automatically loaded and applied. If you chose any other data type, go to the Filing page and click the Load tab, and load the newly transferred data into the Standalone software.

## Creating and Editing Shows and Presets

Use the techniques explained throughout this guide to assign routing, rename channels, and to configure other parameters. Then do the following to save and transfer your work to a complete system.

### To save and transfer VENUE data from the standalone software to the complete system:

- 1 Connect a USB storage device to an available USB port on your laptop.
- 2 Using the Save tab of the Filing page, save data to disk.
- 3 Go to the Filing page and click the Transfer tab, and transfer saved data to a compatible USB storage device.
- 4 Connect the USB storage device to an available USB port on the complete system.
- 5 Use the Transfer tab of the Filing page to transfer the VENUE data from the USB storage device.
- 6 Use the Load tab of the Filing page to load the transferred data.

## CD Transfer

The VENUE system provides a CD-ROM drive that can also be used as a source device for VENUE data transfer. (You cannot write data to the FOH Rack CD-ROM drive; it is read-only.)

### To use a CD for transfer:

- 1 Using the Standalone software on a laptop or other computer, create and save a show.
- 2 Locate the VENUE data folder on the system drive.
- 3 Copy that folder and its contents to a CD-ROM. Make sure the folder is at the root level of the CD-ROM.
- 4 Burn or write the disc as a Windows-compatible CD-ROM.
- 5 Insert the CD-ROM into a VENUE CD-ROM drive.
- 6 In the Filing screen, select the CD-ROM drive as the source for file transfer.
- 7 When the transfer is complete, eject the CD-ROM.

 Leaving a disc in the CD-ROM drive of a VENUE system can slow down the response of some software screens, so it is recommended that you not leave any disc in the drive during a performance. This only applies to a VENUE CD-ROM drive (not the laptop on which you're running the standalone software).



---

## Exporting System Information and Patchbay Information

With Standalone software, a complete system description and/or the contents of each Patchbay page can be exported to a text file. These can be useful for generating an input list (line list) directly from the system. For example, build and customize the Patchbay for an upcoming show, then export and print the channel names list for use during sound check.

### To print a system description:

- 1 Go to the Options > System tab.
- 2 Click the Info button and follow the on-screen instructions to print a complete system description.

For more information, see “VENUE System Information Export” on page 113.

### To export Patchbay names:

- 1 Go to the Patchbay page you want to export.
- 2 Click the Export Patch List icon in the upper right corner of the screen.

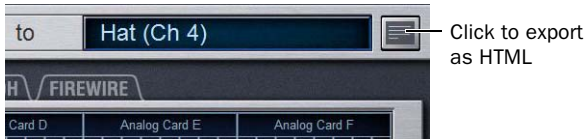

*Export Patch List button*

The Patchbay names appear in an open HTML file that you can save and print, or open in an HTML-compatible application for formatting or other modification. For more information, see “Patch List Export” on page 114.

## **Part VI: Specifications**



# Chapter 25: Mechanical Specifications

VENUE Profile Console Mechanical Specifications	
Maximum Height (front)	3.2 inches (81 mm)
Maximum Height (rear)	6.8 inches (169 mm)
Maximum Width	45.21 inches (1150 mm) with endcaps 44 inches without endcaps
Maximum Depth	31.11 inches (790 mm)
Weight	90 lbs (40.8 Kg)
Power Requirements	100–240 V, 50–60 Hz, 160 W
USB Ports (5)	USB 1.0/USB 2.0
GPI In Port	DB-25 D-Sub, female
GPI Out Port	DB-25 D-Sub, male
Footswitch Connectors (2)	1/4-inch TRS
MIDI (In/Out)	5-pin DIN female
Word Clock (In/Out)	BNC female
VGA Port	DB-15 mini-female (1024 x 768 resolution)
ECx Ethernet Control	RJ-45 (for ECx remote control)
Console Light Connectors (2)	XLR3-F
FOH Link Connector (to Mix Rack, FOH Rack)	MIL connector
Max FOH Link cable length	11 ft (3.35 m)

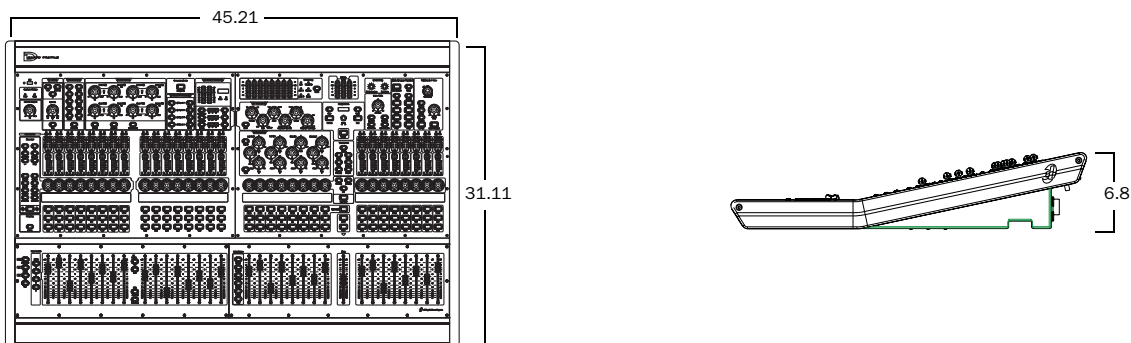

VENUE Profile dimensions

See the *Mix Rack Guide*, *FOH Rack Guide*, and *Stage Rack Guide* for specifications on those units.



# Chapter 26: Audio Specifications

VENUE Profile Console Audio Specifications	
Internal Sample Frequency	48 kHz
External Sample Frequency	48 kHz +/- 10 ppm (word clock input)
Processing Delay	less than 2.8 ms (96 channels, stage input through L-R bus to stage output)
Internal Processing	up to 48-bit, fixed point 288 dB internal dynamic range
Frequency Response	+/- 0.5 dB (22 Hz – 20 kHz BW, relative to 1 kHz)
THD + N	less than 0.01% Stage input to L-R bus, input gain @ min, -1 dBFS output, 20 Hz – 20 kHz BW
Dynamic Range	108 dB typ
Maximum Voltage Gain	84 dB (stage input to L-R bus, channel & L-R faders @ max)
Crosstalk	-100 dB typ (Adjacent stage inputs to L-R bus, @ 1 kHz)
Residual Output Noise	-90 dBu typ (22 Hz – 20 kHz BW)

VENUE Profile Headphone Output	
Connector	1/4-inch TRS unbalanced
Output Impedance	50 ohms
Max RMS Power Output (at +21 dBu:	(with 32-ohm phones) 20 mW
	(with 600-ohm phones) 130 mW

VENUE Profile Talkback Mic Input	
Connector	XLR3-F
Phantom Power	+15V @ 6mA (always on)
Sensitivity (fixed)	-20 dBu
Input Impedance	20K ohms

*All specifications subject to change.*

**Mix Rack, FOH Rack, and Stage Rack** For audio specifications on Mix Rack, FOH Rack, or Stage Rack, see the guide that came with that rack. If your racks include any VENUE expansion options, see the guide that came with each option.





# Chapter 27: Signal Flow Diagrams

## VENUE Profile Systems: Input Signal Flow

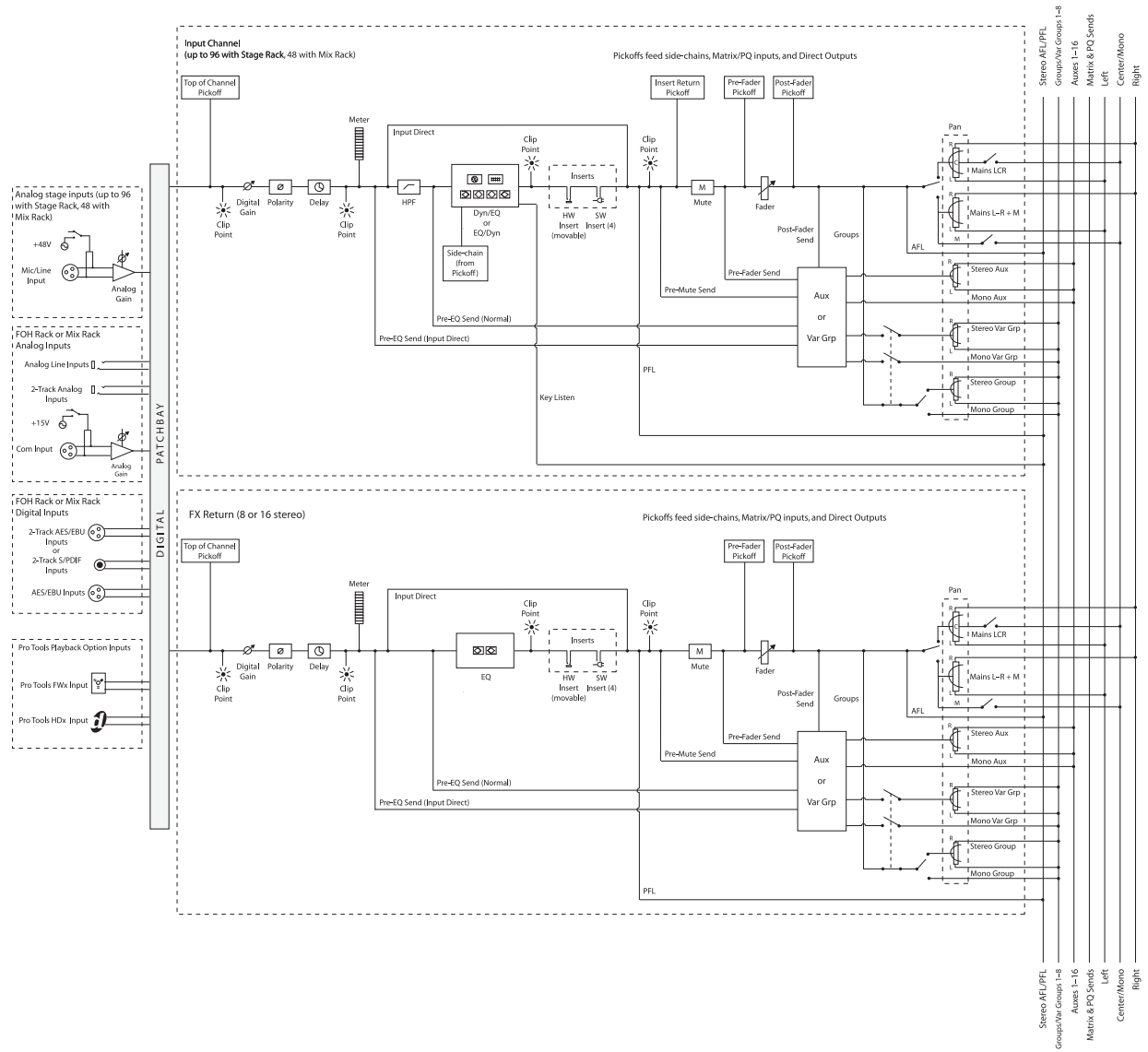

# VENUE Profile Systems: Output Signal Flow

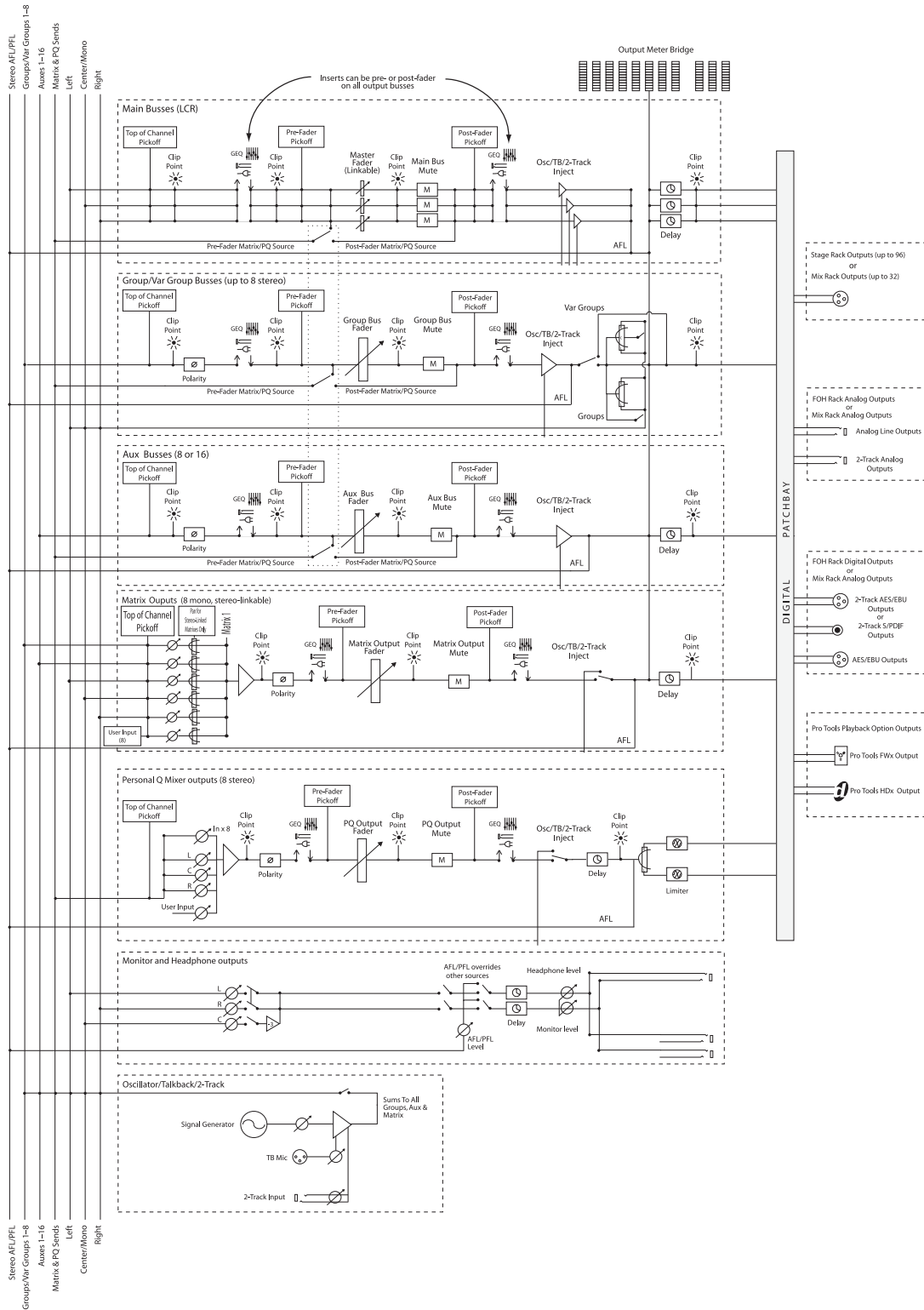

# Chapter 28: Troubleshooting

This chapter provides troubleshooting and problem solving information. It includes a table of problems and solutions that provides answers to common questions, explains on-screen text messages, and refers you to specific sections later in this chapter or elsewhere in this guide for details and instructions.

## Problem Solving

The following table provides descriptions of situations that may arise while operating a VENUE system and includes common questions, symptoms and error messages, along with possible solutions.

*Table 29. Troubleshooting Errors and Messages*

Symptom or Message	Possible Cause	Solution
<b>Faders, Switches, Channels, and Devices</b>		
Fader stuck	Fader path was blocked during startup calibration	Reset the unit on which the stuck fader resides by right-clicking the unit in the Options > Devices page and choosing Reset. If possible, wait for a silent portion of a performance to avoid unexpected gain changes upon reset. For details, see “Hardware Monitoring Window” on page 240).
Only faders and mutes are working	Backup personality is in effect	Wait for the system to recover and follow instructions on-screen to resume operations (see “Resuming Normal Operation” on page 238).
Channel meter Stereo LED is flashing	Indicates a difference of 12 dB or more between the two sides of the stereo signal.	Trim source levels or input gains to balance.
Cannot pan an Aux Send from the ACS	Aux panning is configured to follow channel pan	In the Options > Busses page, select the Follows Channel Pan option. Deselect for each Aux Send you want to pan independently from channel pan.
<b>Startup and Restarts</b>		
System failure and restart, then the Resume Operations dialog appears	The VENUE software has been forced to restart and the backup personality is now in effect.	Continue mixing using features available while the backup personality is in effect (see “In Case of System Failure” on page 237). Follow the instructions on-screen to resume operations after a restart (see “Resuming Normal Operation” on page 238).

Table 29. Troubleshooting Errors and Messages

Symptom or Message	Possible Cause	Solution
Repeated failures	An incompatible plug-in, a corrupted data file or application software, or a hardware error.	<p>Check to make sure you are using the most current versions of all your plug-ins (check with the manufacturers). If failures occur only when you try to use a certain plug-in, disable that plug-in and see if problems go away. Try re-installing plug-ins that are causing problems.</p> <p>Determine if a certain Show file causes the system to fail consistently. If so, delete that file and see if problems persist. For additional options, see “Performing a Soft Reset” on page 239.</p> <p>Clear the console from the Options &gt; System Config page and see if problems persist.</p> <p>If necessary, you can reinstall VENUE software (see “Updating or Re-Installing” on page 241).</p> <p>If you suspect problems with the system hard drive, or the system software, you can do a complete restore (see “Full System Restore” on page 241).</p> <p>Power down all equipment and check all cards and cable connections and power supplies.</p>
<b>Plug-Ins</b>		
The plug-in racks need to be re-initialized	The racks have gone offline. The racks go offline whenever the backup personality is in effect, and after some conditions in which a plug-in or the DSP host failure causes significant problems.	Follow the instructions on-screen to reset the racks (see “Re-Initializing the Plug-In Racks” on page 238).
One or more plug-ins are unavailable	A Show was loaded that references plug-ins which are unavailable on the current system	<p>Install the plug-ins, if available (see “Installing and Authorizing Plug-Ins” on page 151).</p> <p>Remove or replace the plug-ins in the Show, or load a different Show file.</p>
	A plug-in is not fully compatible and is causing failures	<p>Check all plug-ins to make sure you are using the most recent versions. Go to Options &gt; Plug-Ins and click the plug-in to display the version number.</p> <p>Try disabling plug-ins one-by-one to see if doing so eliminates problems (see “Enabling and Disabling Installed Plug-Ins” on page 154).</p>
Plug-in authorization dialogs appear every time the system starts or restarts	A plug-in is installed that needs to be authorized for demo or full use.	<p>Click Quit to dismiss the authorization dialog and continue starting up (the plug-in will be unavailable).</p> <p>Click Try to use the plug-in for a limited time in Demo mode.</p> <p>Click Authorize if you are ready to authorize a plug-in using an iLok. (See “Installing and Authorizing Plug-Ins” on page 151.)</p>
	A plug-in demo has expired	Uninstall the plug-in listed in the authorization dialog (see “Installing Plug-Ins Manually” on page 152).
<b>Error Messages</b>		
One or More Units have Failed	Bad or missing connection	<p>Check all cables and connections. Make sure digital grade XLR cables are being used to connect D-Show Main Unit and all Sidecar units (VENUE D-Show systems only).</p> <p>Check to make sure that the last Sidecar in the chain is properly terminated (VENUE D-Show systems only).</p>
	A unit needs to be reset	Reset the component in Options > Devices. If necessary, restart the VENUE system.
Plug-In Racks Need Reset	The racks have gone offline due to the backup personality being in effect, a plug-in has failed, or some circumstances have caused the DSP engines to require a reset.	Follow the instructions on-screen to reset the racks (see “Re-Initializing the Plug-In Racks” on page 238).

Table 29. Troubleshooting Errors and Messages

Symptom or Message	Possible Cause	Solution
Power Supply Alert	A power supply is failing or is not plugged in. A power supply jumper switch is set incorrectly.	Click Review to show the Options > Devices page. Reset units as needed (see “Hardware Monitoring Window” on page 240).
Control Surface Change (VENUE D-Show systems only)	A unit Bus ID has changed, a new console has been detected, or a new sidecar has been detected.	Click to clear the message. Check unit Bus IDs to make sure input channel strips are arranged as desired.
Date & Time Check	System clock setting for time of day should be checked against current time.	Check and reset system time in the Options > Misc page. Incorrect system time can affect data transfer and plug-in authorizations. If clock problems persist, the battery may need to be replaced in the system rack or console (contact VENUE support if you suspect this is occurring).
Sample Rate Conversion Alert SRC OFF LEDs flashing (Systems with DSI option only)	A sample rate mismatch or lack of clock has been detected at a digital input.	No immediate action required; automatic sample rate conversion maintains digital throughput, allowing you to check settings and connections between D-Show and external digital devices later. For more information on digital connections and synchronization, see “Digital Inputs and Sample Rate Conversion” on page 24.
Hardware Monitor Alert	The system has detected a hardware component that is performing above or below its hardware specification.	Click HW Monitor to access the Hardware Monitor Window for the device. See “Hardware Monitoring Window” on page 240.

## In Case of System Failure

VENUE systems include multiple redundancy and fail-safe routines that help protect against problems that could interrupt audio. These include the ability to maintain mix control even if a failure occurs, to reset software and hardware components, and to completely reset and reinstall the system software.

For maximum protection, Redundant Power Supplies are available. For systems that utilize one or more VENUE hardware racks, redundant Snake options are available to provide additional backup system communication for uninterrupted operation.

### Maintaining Mix Control

If at any time the system fails, or if the system is reset or restarted, the VENUE software backup mode is automatically engaged to maintain audio throughput and essential mix control.

While the backup personality is engaged, a dialog appears on-screen in the banner display. The system then begins to reset itself in the background, while you can continue to use the faders and mute switches to perform basic mixing. Plug-Ins continue to process audio but their controls cannot be changed until the process is complete.

### Features that Remain Active

The following essential mixing features remain available while the backup personality is engaged:

- Bank Input Channels (Banks A–D); adjust levels and mutes. (FX Returns are banked independently of Input Channels.)
- Bank to FX Returns; adjust faders and mutes
- Bank Output faders; adjust faders and mutes
- Control VCA masters, including VCA mutes, and have all members of the VCA group reflect VCA adjustments
- Display the correct name for any fader in its LCD display, even while banking
- Meter input signals on the channel input meters, and meter bus outputs on the assignable meters. Meter mode selection buttons remain active on meterbridge (however, Meter mode does not automatically follow output selection, if configured to do so).
- Compressor and gate meters remain active for all Input Channels (however, Comp In and Gate In switches are not available)
- Meterbridge System Status LEDs turn off (VENUE D-Show and Profile only)

- Channel select is disabled for all inputs and outputs
- ◆ Switch the Mute Group Masters, and see the effect on the channels with member-mutes (flashing mute switches)
- ◆ All LCD displays illuminate (orange)
- Adjust near-field monitor and headphone levels

## Unavailable Features

The following features are unavailable while the backup personality is in effect:

- Use the ACS
- Modify any other mixing parameters apart from faders and mutes (for example auxes)
- Use solos or Solo In Place
- Change the input or output routing, or order of inputs
- Make stereo, or unlink stereo to discrete mono channels
- Channel Control and Flex Channel
- Change bus or group assignments, or Group spill
- Change VCA membership, VCA spill, or show VCA members
- Change names or access any Filing functions
- Reconfigure any system parameters in the Options screens
- Access GEQs on the faders (GEQs continue to process audio in backup mode)
- Adjust the parameters of any existing Plug-In
- All LED indicators (except meters) and output fader CAL lights go dark and are inactive

## Resuming Normal Operation

### (Exiting the Backup Personality)

When the system has recovered and is prepared to return to normal operation, the Ready to Resume dialog appears on-screen.

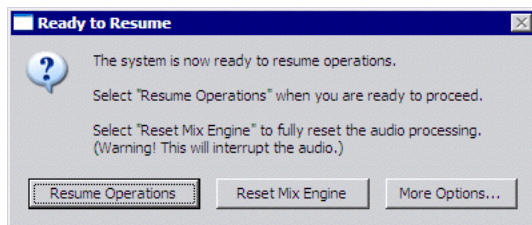

**Ready to Resume dialog**

Choices in the Ready to Resume dialog give you options for how and when critical functions are brought back online. Utility functions are also provided for reset and diagnostics, as described in the following sections.

⚠ *Because this process can interrupt audio throughput, wait for a silent portion of the performance before confirming (such as a break between songs, intermission, or similar).*

**Resume Operations** Use this option if you need to wait for a break in a performance to complete the resumption of normal operations.

**Reset Mix Engines** Use this option to do a full system reset in one step. All operations and controls including the plug-in racks return to full operation. This is the fastest way to resume operations, but it may interrupt audio.

**More Options** Use this option to clear the console (reset, or “zero” the board), or to perform hardware diagnostics.

## Resume Operations

This option begins the process of resuming operations and lets you control precisely when the plug-in racks are re-initialized.

### To begin the Resume Operations process:

- 1 Click Resume Operations. The console resets all parameters and configuration settings. When completed, the Plug-In Racks Reset dialog appears to let you initiate the process of re-initializing the plug-in racks.
- 2 Reset the plug-in racks (see next).

## Re-Initializing the Plug-In Racks

The plug-in racks are taken offline during a Resume Operation process. Whenever the plug-in racks go offline they will need to be reinitialized to resume normal operation.

⚠ *Do not reset the racks until there is a long enough break in the performance that the rack can be fully rebuilt with no signal passing through. This is especially important when using crossover plug-ins or gain-attenuating plug-ins.*

The following conditions apply when resuming operations

- When offline, plug-ins on Input Channels and FX Returns continue to pass and process audio using their settings at the time the racks went offline.
- Offline plug-ins on output channels and busses are muted.
- You will not be able to adjust plug-ins settings until the racks fully re-initialize.
- Once the racks begin to reinitialize, plug-ins are unavailable and do not process audio.
- During reinitialization, plug-ins are loaded into rack slots according to the last loaded Show file; plug-in racks are turned off (all assigned plug-ins are made inactive).
- When all plug-ins have loaded and the racks initialized, the system displays a dialog alerting you that the racks are ready to be brought back online (reactivated). This is provided as a final precaution against sudden changes to audio when plug-ins resume processing.

Shortly after you confirm that you want the racks brought back online, plug-ins resume processing audio and all parameters become available for editing.

### To re-initialize (reset) the racks:

1 In the Plug-In Racks Reset dialog, click Reset to begin the plug-in rack re-initialization.

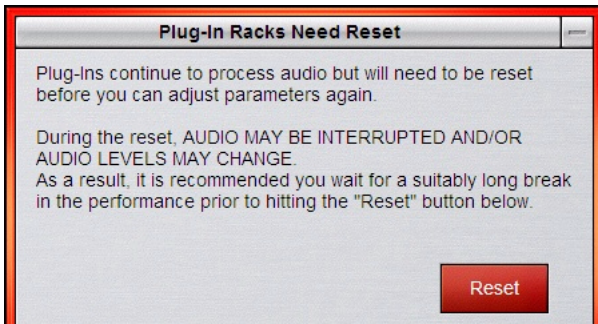

Resetting the plug-in racks

When this step is completed, the Plug-In Racks are Ready dialog appears alerting you that the plug-in racks are ready to be re-activated.

2 Click Use Racks to confirm that you want the racks to be re-initialized. Status is shown on-screen. After the process is complete, the console and all plug-ins are operational again.

### Reset Mix Engines

Use this option to do a full system reset in one step. Reset Mix Engines resumes all operations automatically, including the console, settings, and plug-in racks.

 *Audio may be interrupted or may change levels during this reset procedure.*

### To reset the Mix Engines and all operations immediately:

- Click Reset Mix Engines in the Ready to Resume dialog.

Operations are brought back online; no further interaction is required (no warning or confirmation dialogs appear).

### More Options

Additional options are provided to clear the console, or to run DigiTest (hardware diagnostics).

### To access additional options:

- Click More Options.

After clicking More Options, a dialog is displayed that provides the following options.

### Clear Console

- Click Clear Console to reset all parameters on all channels to their factory default settings.

### Run DigiTest

DigiTest is hardware diagnostics software for VENUE systems. Only use DigiTest at the request of a VENUE technician to diagnose specific hardware problems.

## Performing a Soft Reset

If your VENUE system ever needs to be reset, do the following:

### To restart the system:

- Go to the Options > System page.
- Hold Default (Alt) and click the Shut Down button.



If restarting the system does not correct a problem, you may have to reset hardware components, identify and remove any incompatible plug-ins, or reinstall VENUE software using the System Restore CD.

### Additional Reset Options

Additional shortcuts are provided while restarting the system, which let you do the following:

- Back up the current show settings and clear the console. Use this option if you suspect an auto-saved setting has become corrupted. This lets you save your most recent settings and clear the console without having to do a full system restore.  
– or –
- Launch into Explorer, to be able to manually manage software components. Use this option to troubleshoot the system if problems arise early in the startup process and persist through repeated restarts.

### Backup and Clear Console

#### To backup and clear the console at restart:

- Start or restart the system.
- Watch the screen closely during the startup process. As soon as the cursor becomes visible (and before the VENUE software logo screen appears) press and hold the C key on the computer keyboard. Continue to hold the C key (do not press it repeatedly).
- A dialog appears that lets you choose to backup your auto-saved settings and clear the console, or to continue and load settings normally.

 *If you press the C key too early in the startup process, the USB keyboard is reset instead of calling the Backup and Clear dialog. If you do not see the backup and clear dialog, repeat the restart process and try again.*



## Startup in Explorer

**To start up the system in Explorer (bypassing VENUE software):**

- 1 Start or restart the system, as necessary.
- 2 Watch the screen closely during the startup process. As soon as the cursor becomes visible (and before the VENUE software logo screen appears) press and hold the E key on the computer keyboard. Continue to hold the E key (do not press it repeatedly) until you see the Explorer desktop.
- 3 From Explorer, you can manually find and delete suspect data files, plug-ins, or perform other file management tasks.

 *If you are unsure about how to troubleshoot a computer and its files, it is recommended that you contact VENUE customer service.*

---

## Hardware Monitoring Window

VENUE systems provide the Hardware Monitoring window in which performance of hardware components can be viewed and monitored.

 *The Hardware Monitoring window is not available in the Standalone version of VENUE software.*

## Accessing Hardware Monitoring

**To access the Hardware Monitoring window, do any of the following:**

- Press Ctrl+Shift+M at any time to open the Hardware Monitoring window.
- In the Options > Devices page, right-click on a unit and choose Hardware Monitoring in the pop-up menu. This opens the Hardware Monitoring window for the selected device.
- If the Hardware Monitoring Alert dialog appears on-screen, click to select Show Hardware Monitor. The Hardware Monitoring Alert dialog for the problem device appears automatically and identifies the reading that is out of specification.

The Hardware Monitoring Alert window is only displayed once per device (should a problem ever be detected with that device).

The following is an example of the Hardware Monitoring Alert:



**Hardware Monitoring Alert**

Should a problem occur with any of the components in your system, the Hardware Monitoring window will provide information that will be useful in troubleshooting while in contact with VENUE customer service.

---

## Resetting Hardware Components

**(VENUE Profile and D-Show Systems Only)**

Some VENUE hardware can be reset from the Options > Devices screen, or by power-cycling the component. It is recommended that you perform a reset if, for example, the Hardware Monitor Alert dialog appears, or if a connected device stops communicating with the rest of the system.

## Indication

The system software will display error messages alerting you if a device fails or is no longer available.

The system remembers the last hardware configuration used. If it doesn't find all units at the next startup, it displays those units as grayed out in the Options > Devices page. Units remain offline (and the system displays error messages alerting you to their absence) until either the units are powered up and come online, or you tell the system to forget the offline units by right-clicking the missing devices and choosing Forget.

**To reset system hardware:**

- 1 Put the system in Config mode.
- 2 Go to the Options page and click the Devices tab.
- 3 Right-click any displayed hardware components:
  - Console
  - Inputs section
  - ACS sections
  - Outputs section

#### 4 Choose Reset.

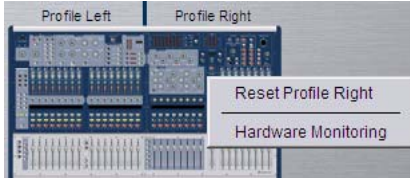

Resetting a unit in the Options > Devices page

## Using the System Restore CD to Update or Restore the System

One copy of the System Restore CD is included with each system. The System Restore CD provides software installers to update or restore a system.

**Updating or Re-Installing** Updating or re-installing system software lets you replace VENUE software (including new installers for factory-installed plug-ins) but preserve any saved Shows and Presets. Use this option to update system software or firmware, or to re-install system software or the installer for a factory-installed plug-in.

Factory-installed VENUE plug-ins are immediately available to be reinstalled from the Options > Plug-Ins page. Plug-ins that cannot be re-installed from the Options > Plug-Ins page must be reinstalled from their installer discs.

**Full System Restore** Performing a full system restore completely uninstalls system software before replacing it with new software. All data folders and files are removed. Be sure to transfer and archive needed data before performing a system restore. Factory plug-in installers will be available automatically, as part of the system restore. All other plug-ins must be re-installed from their installer discs.

 A System Restore CD and CDs of any plug-in installers should be kept with the system at all times.

### To start, update, or restore a system using the System Restore CD:

- 1 Make sure outputs, speakers, and power amps are muted.
- 2 Insert the System Restore CD into the VENUE system CD-ROM drive.
- 3 Go to the Options > System page.
- 4 Alt-click the Shut Down button.
- 5 Click to restart the system, then press and hold F10 on the keyboard until either of the following occur, depending on your hardware:
  - If the system begins to boot off the Restore CD, proceed to step 4.
  - If the Restore CD text screen appears, release F10 and use the Up and Down Arrow keys to select the CD drive, then press Enter. This launches using the software on the inserted System Restore CD. Continue to step 4.
- 6 Do one of the following to update or restore system software:
  - To update system software while keeping any Show files and Preset files on the system, press “u” (lower-case). In the Update confirmation screen, press Shift+U (upper-case) to proceed. Follow the on-screen instructions to begin installation.
  - or –
  - To fully restore the system (completely removing all files on the system), press “r” (lower-case). (Or press P to return to the previous screen.) When the Restore confirmation dialog appears, press Shift+R to proceed. Follow on-screen instructions to complete the system restore operation.
- 7 If prompted, select an option in the Ready to Resume dialog as appropriate (see “Resuming Normal Operation” on page 238). Follow any additional instructions on-screen for plug-ins or authorizations.
- 8 Remove the System Restore CD from the CD-ROM drive.
- 9 Re-install any plug-ins from their installer discs, as necessary.

 Before re-installing plug-ins after updating system software, check if there is a more current version available. If an updated version of a plug-in is available, install it from its installer CD-ROM.

**To cancel without changing any installed software:**

- Press E to exit from the Welcome to VENUE System Restore screen. The system resumes starting up using the currently installed version.

**⚠** *If you cancel a full system restore or an update, you may experience installation errors about unavailable space. If this occurs, repeat the system restore process, making sure to complete it in one pass.*

**Updating Firmware**

During an update or system restore, the system checks for new firmware. If newer firmware is found on the System Restore CD, it is installed while the system starts up.

**Reinstalling Plug-Ins After Restoring the System**

The System Restore CD reinstalls all system software and factory-installed plug-in installers only. DigiRack Plug-ins and any additional plug-ins from Avid or its Development Partners must be re-installed separately. (Factory-installed plug-ins will be available from the Previous Installs selector to re-install immediately after a system restore; other plug-ins must be completely re-installed.)

 *For instructions on re-installing plug-ins, see Chapter 18, "Plug-Ins."*

# **Part VII: Reference**



# Chapter 29: Control Surface Reference

This chapter describes the ports and connectors on the VENUE Profile console.

## VENUE Profile Console

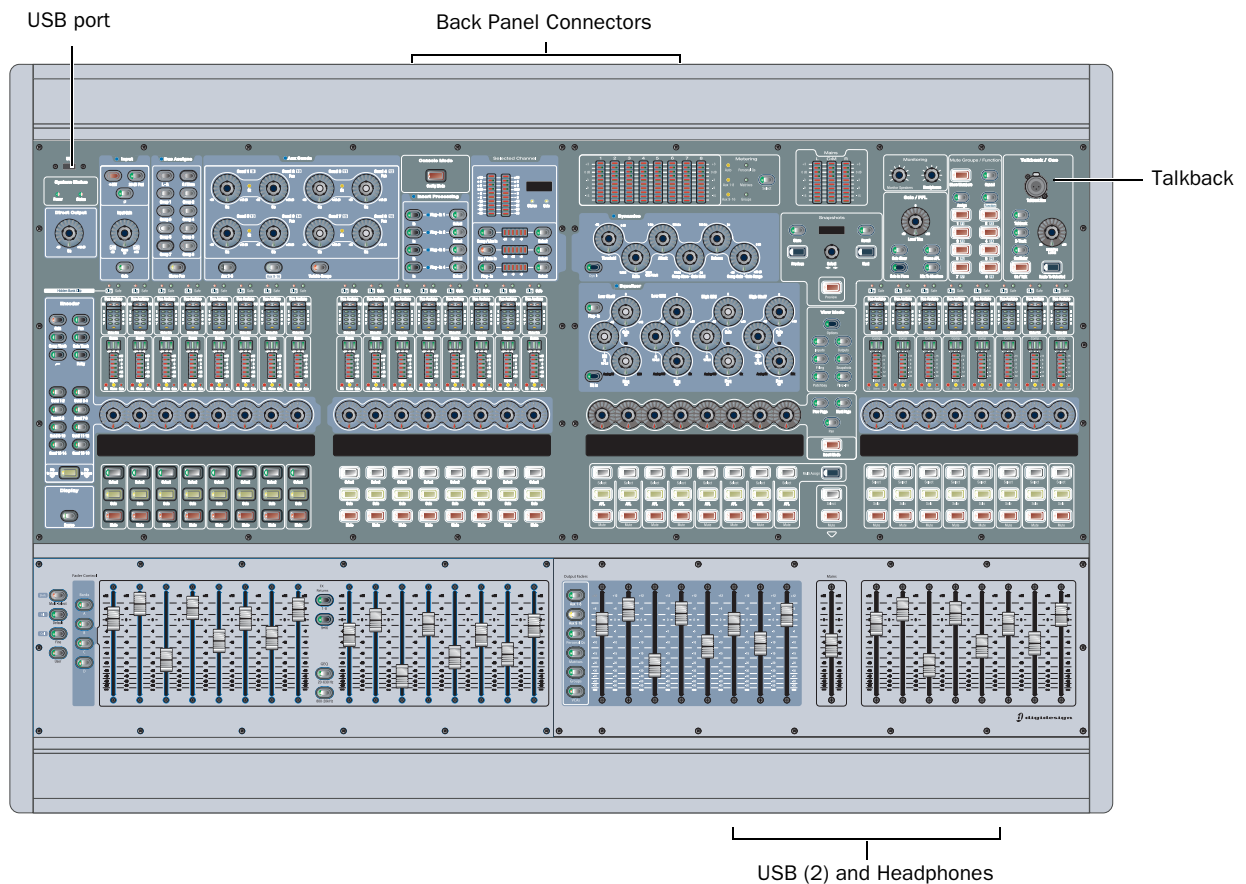



Figure 20. VENUE Profile connectors

### Top Panel USB Port

A USB 1.1 port is provided on the top panel, in the upper left corner of the console. Use this USB port for iLok Smart Keys or any other USB device such as a key disks.

 For faster data transfer to and from USB storage devices, use the USB 2.0 ports on the Mix Rack and FOH Rack.

### Front USB Ports

Two USB 1.1 ports are provided on the front of console. Use these ports to connect a USB keyboard and a Trackball (or mouse). These ports also support iLoks and USB key disks.

### Headphone Connector

The headphone connector on the front of the console is a standard 1/4-inch stereo (TRS) headphone jack. The connector is fed by the Monitor bus.

## Back Panel

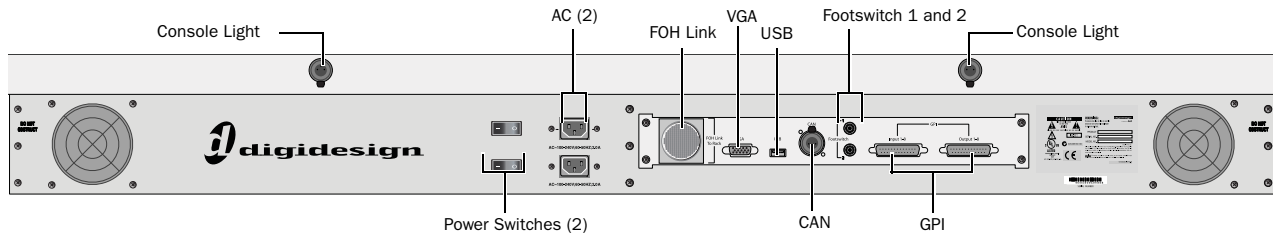

Figure 21. D-Show Profile back panel

### Power Switches

The Power switches apply power to the console using their corresponding AC connectors.

### Power Connectors

Two male, 3-pin IEC power sockets with cable retaining clips are provided, one for each of the internal power supplies. Two North American standard IEC power cables are provided with each Profile console.

### FOH Link

FOH Link connects Profile to the Mix Rack or FOH Rack. One FOH Link cable is included with each FOH Rack.

### VGA

A single, female VGA connector is provided for driving a compatible video display (not included).

### CAN Bus

This XLR3-M connector is not functional.

### Footswitches

Two female 1/4-inch TS footswitch jacks are provided for switch input. Footswitches can be normally open or normally closed, latching or momentary. Functions are assigned to these jacks on-screen in the Options > Events page.

### USB Port

A single USB 1.1 port is provided on the back panel for interfacing with iLoks, keyboards, pointing devices or key disks.

### Console Lights

These two XLR3-F jacks connect to the included console lights.

---

## GPI (General Purpose Interface)

### GPI Input Specifications

A 25-pin, male D-Sub connector provides a total of 8 General Purpose Interface (GPI) Inputs.

- Inputs are logic inputs with pull-ups. They may be driven by logic outputs or contact closure to ground.
- Input signal range is 0 to 5.5V. The inputs are ESD protected.
- Input signaling uses standard TTL logic levels: 0.8V or less for a logic low. 2.0V or greater for a logic high.
- Inputs are compatible with 5V TTL (e.g. 74LS series), 5V CMOS (e.g. 74HC series), 3.3V CMOS (e.g. 74LVC series)
- Inputs provide an internal 5K ohm pull-up to +5V.
- All Inputs are referenced to the same internal ground, which is connected to AC safety ground.



## GPI Input Connector Pin Assignments

The D-Show Profile GPI Input is a male DB-25 connector.

### GPI Input Connector Pin Assignments

Pin Number	Function	Comments
1	Input 1	Logic level (TTL, CMOS) input with pullup
2	Input 2	Logic level (TTL, CMOS) input with pullup
3	Input 3	Logic level (TTL, CMOS) input with pullup
4	Input 4	Logic level (TTL, CMOS) input with pullup
5	Input 5	Logic level (TTL, CMOS) input with pullup
6	Input 6	Logic level (TTL, CMOS) input with pullup
7	Input 7	Logic level (TTL, CMOS) input with pullup
8	Input 8	Logic level (TTL, CMOS) input with pullup
14, 15, 16, 17, 18, 19, 20, 21	Ground	All ground pins are connected together internally
9, 10, 11, 12, 13, 22, 23, 24, 25	Reserved	Do not use

### Pinout for GPI Input Connector

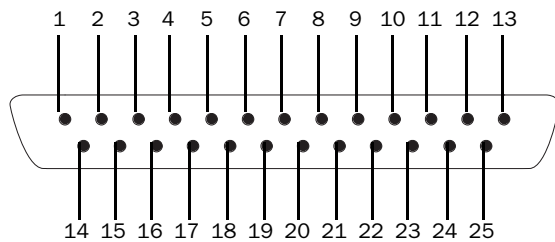

Pinout for Profile DB25M GPI Input port (looking at back of console)

## GPI Output Specifications

A 25-pin, female D-Sub connector provides a total of 8 General Purpose Interface (GPI) Outputs.

- Outputs are isolated, floating relay contacts (contact closure).
- Switched voltage is 200V max; 0.5A max.
- Switched voltage with respect to safety/chassis ground is 300V max.

**⚠** *The Profile GPI Outputs can switch 500 mA maximum. This applies even to short term current surges. This limit can be exceeded when driving a capacitive or incandescent lamp load. An incandescent lamp may draw as much as ten times its steady state current when first turned on. Therefore such lamps are typically not appropriate loads for the GPI Outputs, and should instead be controlled by a secondary relay.*

### GPI Output Power Specification

The GPI Output connector also provides +12VDC at up to 200 mA for powering external devices, such as relays or LEDs. The ground return that is provided is the D-Show Profile internal system ground, which is connected to AC safety ground.

### GPI Output Ground Connections

The GPI Outputs provided are isolated contact-closure style. Each GPI output is presented on a pair of pins (see “GPI Output Connector Pin Assignments” on page 248). These two pins represent the two sides of a switch that can be opened and closed. If it is desired to drive a signal to ground, then one of the pins must be wired to ground, and the other to the signal to be controlled.

## GPI Output Connector Pin Assignments

The D-Show Profile GPI Output is a female DB-25 connector.

### GPI Output Connector Pin Assignments

Pin Number	Function	Comments
1, 14	Output 1	Floating contact closure output
2, 15	Output 2	Floating contact closure output
3, 16	Output 3	Floating contact closure output
4, 17	Output 4	Floating contact closure output
5, 18	Output 5	Floating contact closure output
6, 19	Output 6	Floating contact closure output
7, 20	Output 7	Floating contact closure output
8, 21	Output 8	Floating contact closure output
12, 13, 24, 25	+12V auxiliary power	Maximum total load 200 mA All +12V pins are connected together internally
9, 10, 22, 23	Ground for auxiliary power	All ground pins are connected together internally
11	Reserved	Do not use

### DB25F Pinout

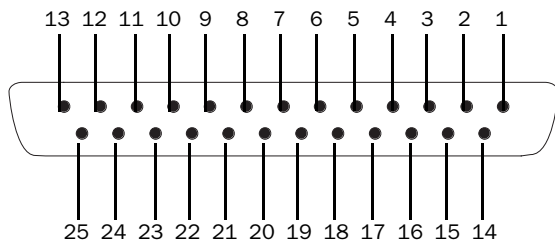

Pinout for Profile DB25F GPI Output port (looking at back of console)

## GPI Wiring Diagrams

The following diagrams provide examples of GPI pinout and wiring for the common uses. All diagrams are shown from the rear (solder side) of the DB25 connector.

### GPI Input Examples

The following diagrams provide simplified wiring examples for a customer-provided DB25 female connector, to attach to the male GPI In connector on D-Show Profile.

#### Wiring a Switch to Drive GPI

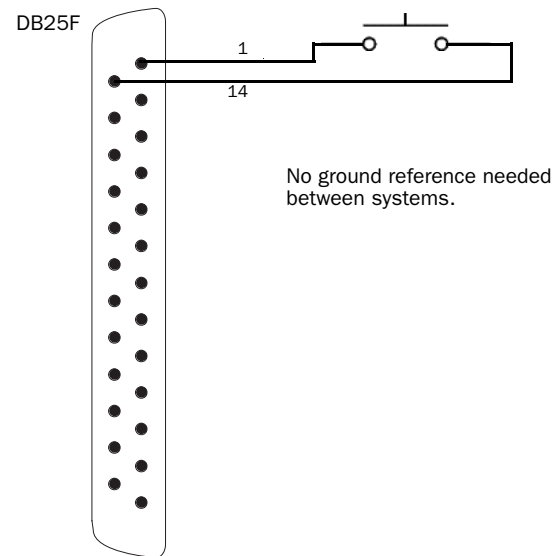

#### Wiring a Relay to Drive GPI

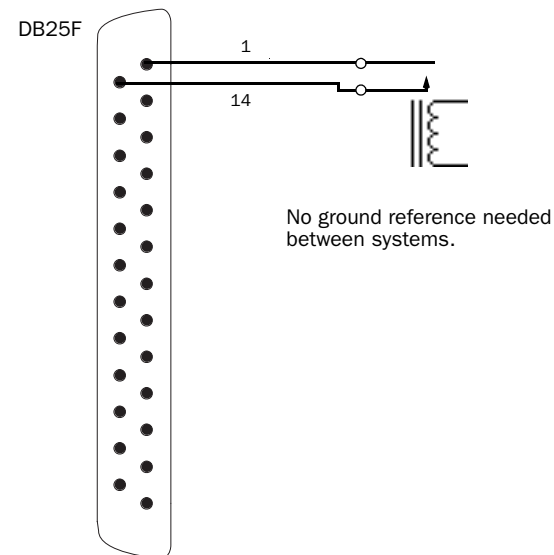

### Wiring a Logic Signal to Drive GPI

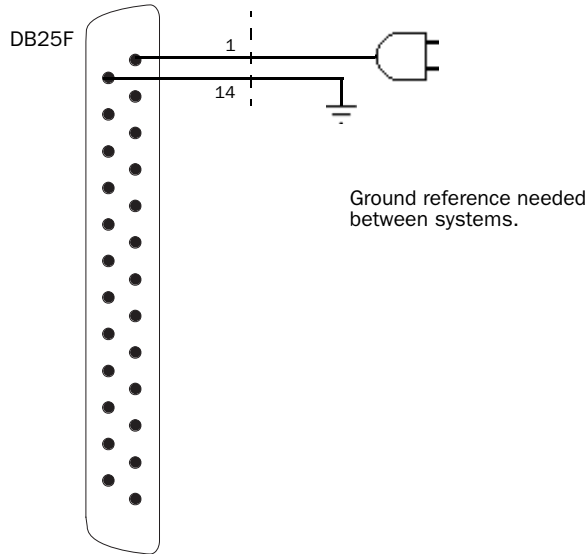

### GPI Output Driving and Powering an LED

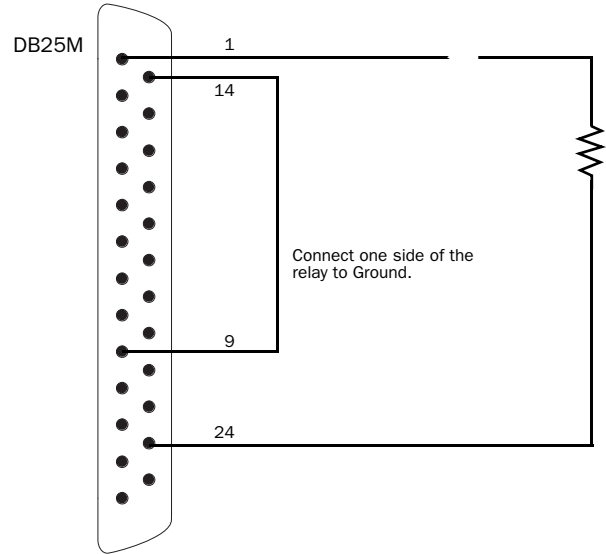

### GPI Output Examples

The following diagrams depict wiring examples for a customer-provided DB25 male connector, to connect to the female GPI Output connector on D-Show Profile.

### GPI Output Driving a Relay to Illuminate a Light

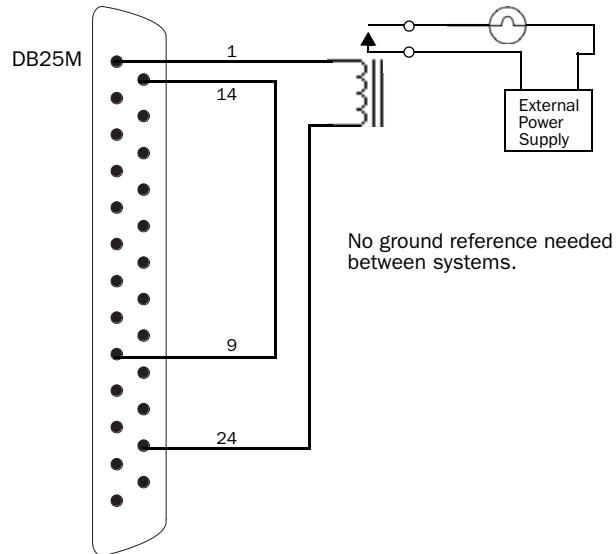

### GPI Output Driving an Externally Powered LED

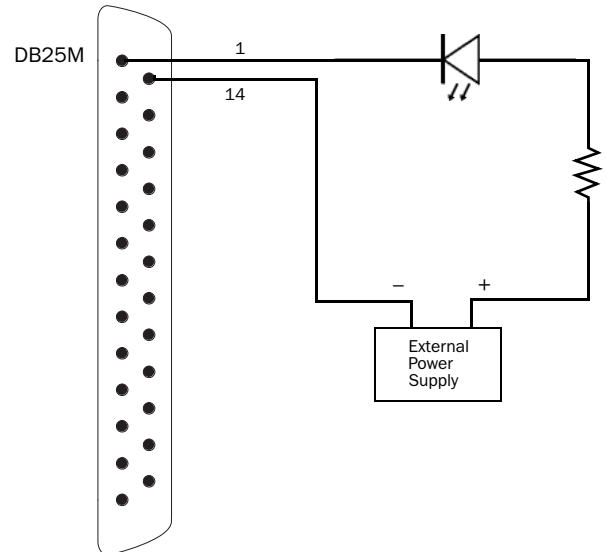

**GPI Output Driving a Logic Input**

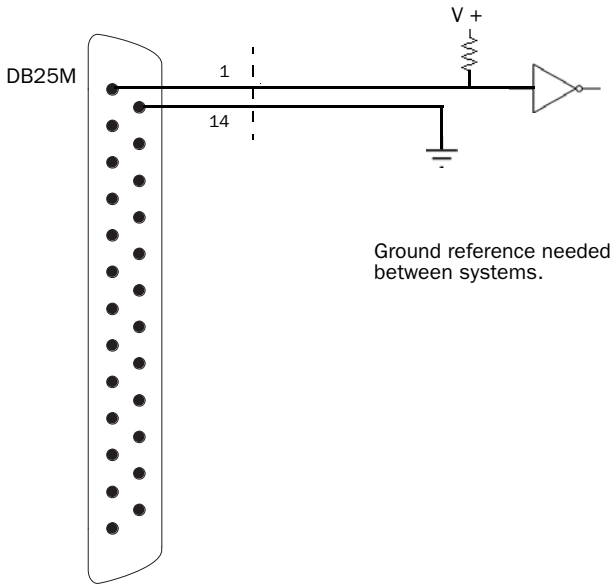

**GPI Output Driving a Relay Using an External Power Supply**

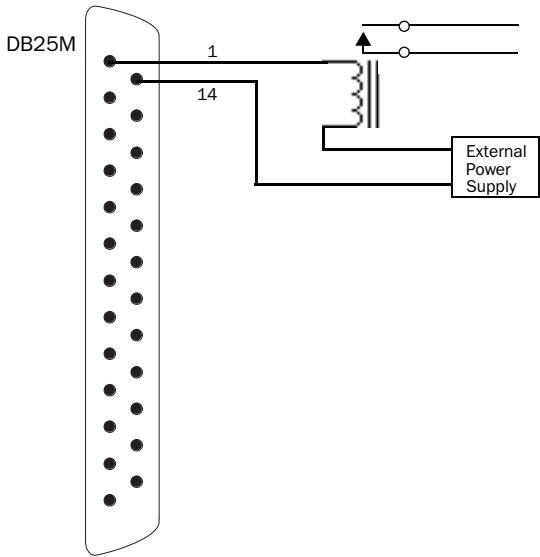

# Chapter 30: ECx

VENUE Profile systems include ECx Ethernet Control. ECx lets you control a VENUE system remotely over an Ethernet network, using compatible wired or wireless network equipment (purchased separately).

---

## ECx Capabilities and Features

ECx provides the following:

- Remote control of a VENUE system from a client computer, including a laptop or Tablet PC
- Exact duplication of VENUE software on the remote client computer

---

## ECx Components

The ECx components of your VENUE system include the following items:

- ECx Control (pre-installed)
- Ethernet cable for connecting the ECx card to your client computer, wireless router, or wireless access point device
- ECx Ethernet Control Software installer CD-ROM (containing ECx host and client software)

---

## System Requirements

The following are required to use ECx with your VENUE system:

- A -qualified router or wireless access point (WAP) device
- A client computer running -qualified Windows or Mac OS X software with wired or wireless Ethernet capability.
- For wireless communication with ECx, 802.11g capable devices are recommended.

Avid can only assure compatibility and provide support for hardware and software it has tested and approved.

For complete system requirements and a list of -qualified computers, operating systems, and wireless devices, refer to the latest compatibility information on our website:

[www.avid.com/compatibility](http://www.avid.com/compatibility)

---

## Installing ECx Host Software

The ECx host software enables your VENUE system to communicate with computers running the remote client software.

To use ECx Ethernet Control, you must do the following:

- Install the ECx host software on your VENUE system.
- Install the ECx client software on your remote computer.

If you need to uninstall the ECx host software from your VENUE system, see “Uninstalling ECx Host Software” on page 252.

If you need to re-install the ECx host software, (after a System Restore or an Update), see “Reinstalling ECx Host Software” on page 252.

After you install the host and client software, see “Overview of ECx Setup and Configuration” on page 253 for information on setting up your VENUE system and client computer for remote operation using ECx.

## Installing ECx Host Software

The ECx Ethernet Control Software installer disc contains the ECx host software. This software enables your VENUE system to communicate with computers running the remote client software.

**To install ECx host software on your VENUE system:**

- 1 Insert the ECx installer disc in the system CD-ROM drive.
- 2 Do one of the following to put your system into Config Mode:
  - Press the Console Config switch on the console.
  - or –
  - Double-click the Mode box in the bottom-right corner of the screen.
- 3 Go to Options > System page and click Update.
- 4 Click Yes to exit VENUE software and begin the installation.
- 5 After the installation is complete, the system restarts.



*When you perform an Update or a System Restore of your VENUE system, you must reinstall the ECx host software. See “Reinstalling ECx Host Software” on page 252.*

## Installing the ECx Client Software

The ECx Ethernet Control Software installer CD-ROM contains remote control applications for both Windows and Mac.

### Installing the ECx Client in Windows

#### To install the ECx Control client application (“UltraVNC”) in Windows:

- 1 Insert the ECx installer disc in the computer CD or DVD drive.
- 2 Open the Windows Client folder.
- 3 Double-click the “UltraVNC-Viewer.exe” file.
- 4 Follow the on-screen installation instructions to complete the installation.

### Installing the ECx Client on Mac

#### To install the ECx Control client application (“Chicken of the VNC”) on Mac:

- 1 Insert the ECx installer disc in the computer CD or DVD drive.
- 2 Open the Mac OS X Client folder.
- 3 Double-click the “cotvnc-20b4.dmg” file.
- 4 In the window that opens, drag the “Chicken of the VNC” icon to copy it to a location on your hard drive.

## Uninstalling ECx Host Software

If you need to uninstall ECx software from your VENUE system, you can do so from the system desktop.

#### To uninstall ECx host software from your VENUE system:

- 1 Do one of the following to put your system into Config Mode:
  - Press the Console Config switch on the console
  - or –
  - Double-click the Mode box in the bottom-right corner of the screen.
- 2 Go to Options > System.
- 3 Hold the Control key and click Shut Down to go to the system desktop.
- 4 Locate and double-click the ECx host software uninstall program (C:\Program Files\D-Show Ethernet Control Software\Uninstall.bat).

The ECx host software is uninstalled, and the software automatically restarts.



*The ECx folder will remain on your VENUE system hard drive after uninstalling,*

## Reinstalling ECx Host Software

If ECx is installed on your VENUE system, you will have to reinstall the ECx host software after performing a System Restore or an Update.

**System Restore** If you perform a complete System Restore, the ECx host software must be reinstalled from its original installer disc. See “Installing ECx Host Software” on page 251.

**Update** If you perform an Update, you must still reinstall the ECx host software. You can reinstall without using the ECx installer disc because an Update leaves the ECx installer on your VENUE system’s hard drive. You can also reinstall using the original installer disc.

#### To reinstall after an Update without using the ECx installer disc:

- 1 Remove any USB key disks from all USB ports, and make sure no installer discs are in the CD-ROM drive.
- 2 Do one of the following to put your system into Config Mode:
  - Press the Console Config switch on the console.
  - or –
  - Double-click the Mode box in the bottom-right corner of the screen.
- 3 Go to the Options > Systems page.

Click the Update button.

---

## Overview of ECx Setup and Configuration

You can control your VENUE system (the “host”) with a remote computer (the “client”) using standard VNC (Virtual Network Computing) protocol over TCP/IP, allowing remote access to your system via a wired or wireless Ethernet-based network. This chapter covers the steps for configuring and using ECx.

For a wired network, the steps include:

- ◆ Connecting the remote computer directly to your VENUE system using an Ethernet cable.
- ◆ Setting the IP addresses of your VENUE system and your client computer manually.
- ◆ Enabling remote operation of your VENUE system.

For a wireless network, the steps include:

- ◆ Connecting a wireless router or a wireless access point (WAP) device to your VENUE system.
- ◆ Setting the IP addresses of your VENUE system and your client computer manually or automatically.
- ◆ Establishing a connection between your wireless router and the client computer.
- ◆ Enabling remote operation of your VENUE system.

---

## Connecting a Computer Directly to VENUE

If you are establishing a fixed remote control station and do not need a mobile connection, you can connect the remote computer directly to your VENUE system using an Ethernet cable.

### To connect a computer directly to your VENUE system:

**1** Connect one end of the appropriate Ethernet cable type (with RJ-45 connectors) to the ECx port on your VENUE system, and the other end to the Ethernet port on the computer. The type of cable depends on the operating system of the remote computer:

**Windows** To connect a Windows computer directly to your VENUE system, an Ethernet crossover cable is required. Alternatively, you can use an Ethernet hub and connect standard Ethernet cables between your VENUE system, the hub and the remote computer.

**Mac** To connect a Mac computer directly to your VENUE system, you can use either a standard Ethernet cable or an Ethernet crossover cable.

**2** Configure the VENUE system and the client computer IP addresses manually. See “Setting VENUE and Client IP Addresses Manually” on page 254.

---

## Connecting a Wireless Router or WAP to VENUE

VENUE systems work with standard wireless routers or WAP devices.

Before connecting a wireless router or WAP device, you should configure the SSID of the device so that its wireless network can be easily identified on the client computer. You can specify any unique network name for the device, such as “VENUE Network.”

To configure the SSID and any network security features of your wireless router or WAP, refer to the manufacturer’s instructions.

### To connect a wireless router or WAP device to your VENUE system:

**1** Connect one end of the appropriate type of Ethernet cable to the ECx port and the other end to the Ethernet connector port on the router or WAP. Do one of the following depending on the type of device you are using

- If you are using a wireless router, use a standard Ethernet cable to your VENUE system.
- or –
- If you are using a WAP, use an Ethernet crossover cable to connect to your VENUE system.

**2** Do one of the following:

- If you are using a wireless router or WAP device that does not include a DHCP server function (such as the Cisco Aironet 1230AG), you must configure your VENUE system and the client computer IP addresses manually. See “Setting VENUE and Client IP Addresses Manually” on page 254.
- or –
- If you are using a wireless router that includes a DHCP server function (such as the Belkin Pre-N), you can configure your VENUE system and the client computer to set the IP addresses automatically. See “Setting VENUE and Client IP Addresses Automatically” on page 255.



## Setting VENUE and Client IP Addresses

You can set the IP addresses of your VENUE system and client computer manually or automatically. Do one of the following depending on the configuration of your network:

◆ If you are connecting a computer directly to your VENUE system, or you are using a wireless router or WAP device that does not include a DHCP server function, see “Setting VENUE and Client IP Addresses Manually” on page 254.

– or –

◆ If you are using a wireless router that includes a DHCP server function, see “Setting VENUE and Client IP Addresses Automatically” on page 255.

**⚠** IP configuration changes on your VENUE system and client computer can take up to 2 minutes to become effective. After making changes, be sure to allow sufficient time for the system to assign IP addresses and establish communication between all the components.

*If network communication is not established after allowing sufficient time for IP addressing, then you can verify that you are using the correct cable types, have correctly connected the system, and have working cables.*

## Setting VENUE and Client IP Addresses Manually

Set VENUE and client computer IP addresses manually if you are connecting a computer directly to your VENUE system, or you are using a wireless router or WAP device that does not include a DHCP server function.

### Setting a VENUE System IP Address Manually

To manually set the IP address for your VENUE system:

- 1 In the VENUE software, go to the Options page and click the Interaction tab.
- 2 Under Ethernet Control, click Network Settings.



Ethernet Control section of the Interaction page

3 Select Use the Following Address and enter the following:

- IP address: 10.0.0.1
- Subnet Mask: 255.255.255.0
- Default Gateway: 10.0.0.1

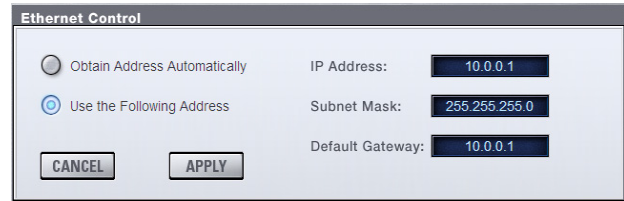

Setting an IP address manually

4 Click Apply.

5 Select Enable Remote Control to activate the VENUE ECx host.

6 Go to “Setting the Client Computer IP Address Manually” on page 254.

## Setting the Client Computer IP Address Manually

After manually setting your VENUE system’s IP address, you need to set your client computer’s IP address.

To manually set the IP address in Windows:

- 1 Go to Control Panels > Network Connections.
  - 2 In the Network Connections window, do one of the following:
    - If you are connecting the computer directly to your VENUE system, right-click the Local Area Connection icon and choose Properties.
- OR –
- If you are connecting using a wireless router or WAP, right-click the Wireless Network Connection icon and choose Properties.
- 3 In the Connection Properties window, double-click Internet Protocol (TCP/IP).

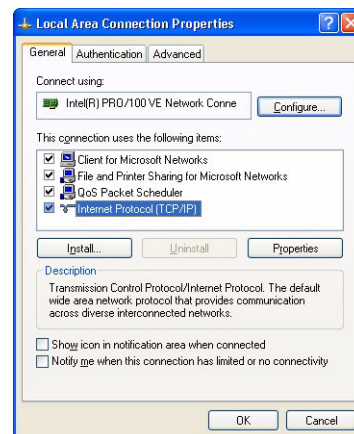

Local Area Connection Properties window

4 In the Internet Protocol Properties window, select “Use the following IP Address” and enter the following:

- IP address: 10.0.0.2
- Subnet Mask: 255.255.255.0
- Default Gateway: (none required)

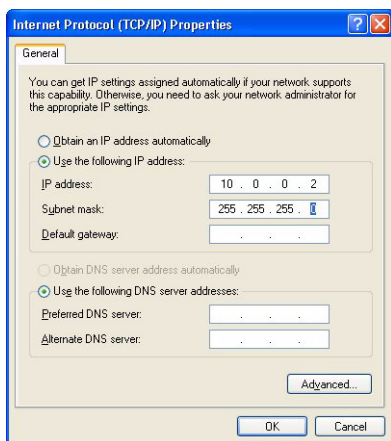

*Internet Protocol Properties window*

5 Click OK to close the Internet Protocol properties window.

6 Click OK to close the Network Connection Properties window.

7 Do one of the following depending on the configuration of your network:

- If you are using a wireless network, go to “Establishing a Wireless Connection” on page 257.
- or –
- If you are using a wired network, go to “Enabling Remote Operation” on page 258.

**To manually set the IP address on a Mac:**

1 Launch System Preferences > Network.

2 Do one of the following:

- If you are connecting the computer directly to your VENUE system, choose Ethernet from the network connections services list.

– or –

- If you are connecting using a wireless router or WAP, choose Airport from the network connections services list.

3 Choose Manually from the Configure menu.

4 Enter the following:

- IP address: 10.0.0.2
- Subnet Mask: 255.255.255.0
- Router: (none required)

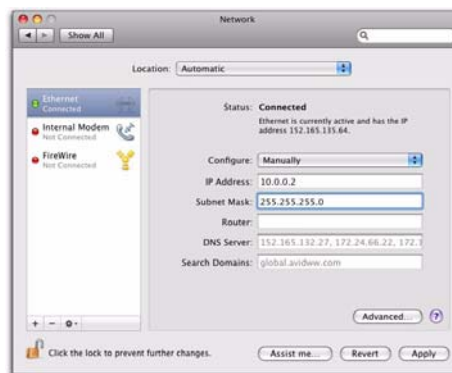

*Network Preferences window*

5 Click Apply.

6 Do one of the following depending on the configuration of your network:

- If you are using a wireless network, go to “Establishing a Wireless Connection” on page 257.
- or –
- If you are using a wired network, go to “Enabling Remote Operation” on page 258.

**Setting VENUE and Client IP Addresses Automatically**

You can configure your VENUE System and client computer to set their IP addresses automatically using DHCP. Set the IP automatically if you are using a wireless router that includes a DHCP server function.

**Setting the VENUE IP Address Automatically**

**To set the IP address of your VENUE system automatically:**

1 In the VENUE software, go to the Options page and click the Interaction tab.

2 Under Ethernet Control, click Network Settings.



*Ethernet Control section of the Interaction page*

3 Select Obtain Address Automatically.

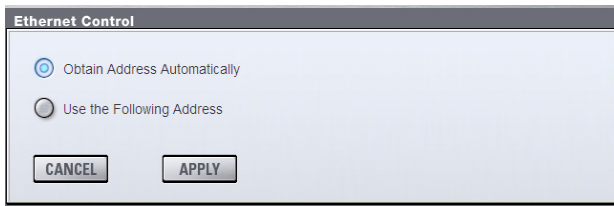

#### Configuring Ethernet Control in VENUE

4 Click Apply.

5 Wait until the VENUE System is assigned an IP address. This may take time (up to two minutes). If no DHCP server is found, the VENUE system will self-assign an IP address.

 *Make a note of the IP address assigned to your VENUE system, as you will need to enter it into the client software.*

6 Select Enable Remote Control to activate the VENUE System ECx host. Your system's status will be displayed as "Waiting for connection."

7 Go to "Setting a Client Computer IP Address Automatically" on page 256.

### Setting a Client Computer IP Address Automatically

After setting the IP address for your VENUE system using DHCP, you need to do the same for your client computer.

#### To automatically set the IP address in Windows:

1 Go to Control Panel > Network Connections.

2 Right-click the Wireless Network Connection icon and choose Properties.

3 In the Connection Properties window, double-click Internet Protocol (TCP/IP).

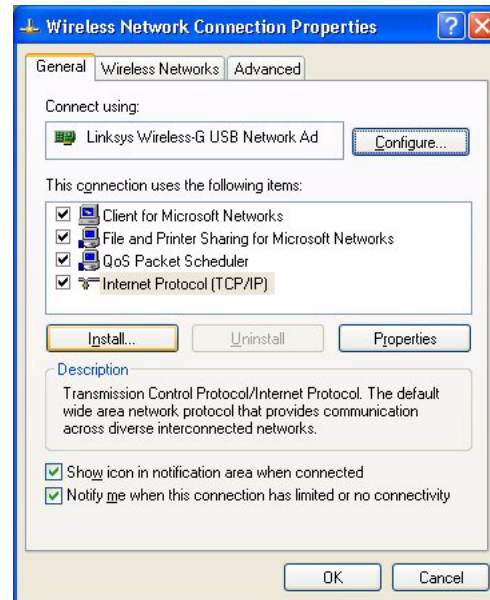

#### Connection Properties window

4 In the Internet Protocol Properties window, select "Obtain an Address Automatically."

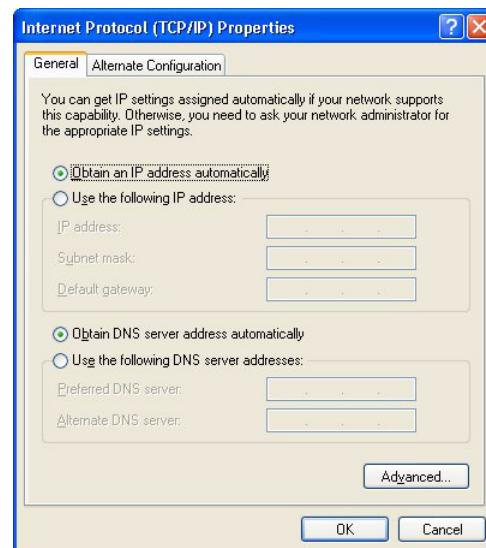

#### Internet Protocol (TCP/IP) Properties window

5 Click OK to close the Internet Protocol properties window.

6 Click OK to close the Network Connection Properties window.

7 Go to "Enabling Remote Operation" on page 258.

**To automatically set the IP address on a Mac:**

- 1 Launch System Preferences > Network.
- 2 Choose Airport from the network connections services list.
- 3 Click the Advanced button, then click the TCP/IP tab.
- 4 Choose Using DHCP from the Configure IPv4 menu.

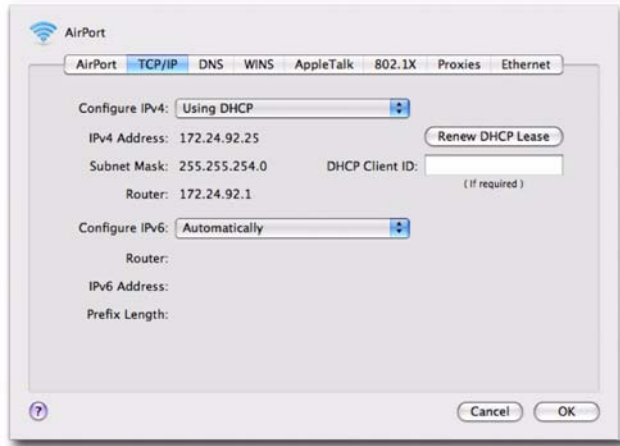

*Airport Network Advanced window*

- 5 Click OK.
- 6 Go to "Enabling Remote Operation" on page 258.

---

## Establishing a Wireless Connection

Once IP addresses are set, you can establish a connection from the client computer to the wireless network.

**To establish a wireless connection in Windows:**

- 1 Go to Control Panel > Network Connections.
- 2 Right-click the Wireless Network Connection icon and choose Properties.

- 3 In the Connection Properties window, click the Wireless Networks tab.

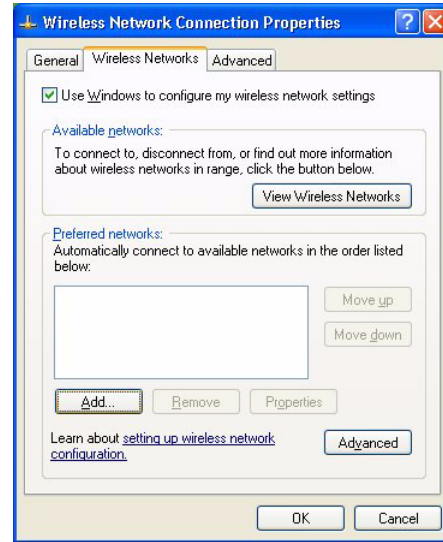

*Configuring a wireless connection in Windows*

- 4 Under Preferred Networks, click Add, and type the SSID of the wireless router or WAP device connected to your VENUE system.
- 5 Choose the Network Authentication and Data Encryption settings to match the corresponding router or WAP configuration settings.

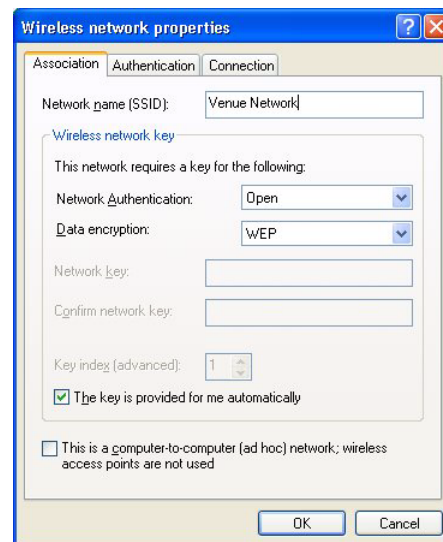

*Entering an SSID and choosing settings in Windows*

- 6 Click OK. The VENUE SSID should appear in the list of available wireless networks.
- 7 Go to "Enabling Remote Operation" on page 258.

### To establish a wireless connection on Mac:

- 1 Go to System Preferences > Network.
- 2 Choose Airport from the network connections services list.
- 3 From the Network Name pop-up menu, choose your network.



### Configuring a wireless connection on the Mac

 If your network does not appear in the Network Name pop-up menu, choose “Join Other Network, type in the name of your network, and click Join. To assign your wireless router or WAP device a network name, see your device’s documentation.

- 4 Go to “Enabling Remote Operation” on page 258.

## Enabling Remote Operation

In order to enable remote operation of your VENUE system, you need to have obtained valid IP addresses for your VENUE system and your client computer. If you are using a wireless network, you also need to have established a network between the wireless router or WAP device that is connected to your VENUE system and your client computer.

### To enable remote operation with a Windows client computer:

- 1 Double-click the “ECx Ethernet Control (UltraVNC Viewer)” icon on your desktop (or go to Start Menu > Programs > UltraVNC > Run UltraVNC Viewer) to launch the UltraVNC Viewer application.
- 2 Enter the IP address of the ECx host (your VENUE system).
- 3 Click Connect.
- 4 Enter the password when prompted (the default VENUE password is “password”) and click Connect.

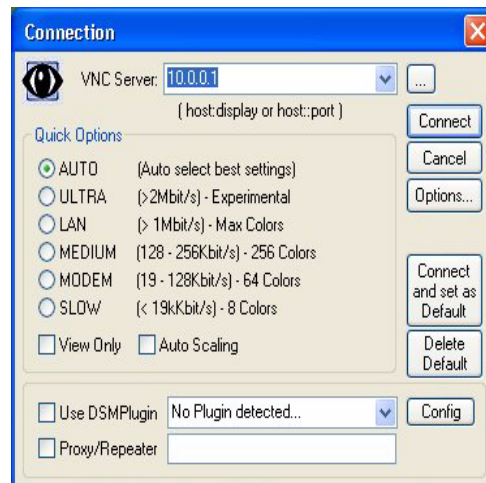

### UltraVNC Viewer window

The client launches and displays the VENUE system screen. You can then view and operate all on-screen controls from the client computer.

**To enable remote operation with a Mac client computer:**

- 1 Double-click the “Chicken of the VNC” icon to launch the application.
- 2 Enter the IP address of the ECx host (your VENUE system).
- 3 Enter the password (VENUE’s default password is “password”) and click Connect.

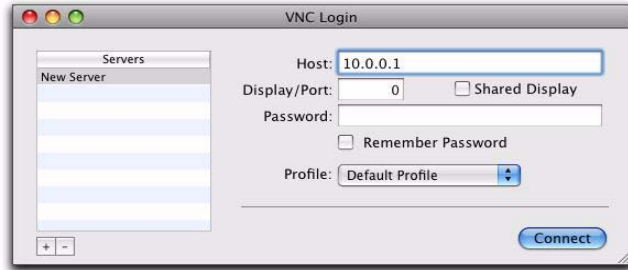

**Chicken of the VNC window**

The client launches and displays the VENUE system screen. You can then view and operate all on-screen controls from the client computer.

---

## Disconnecting ECx

**To disconnect ECx:**

- 1 Close the ECx client application by doing one of the following:
  - In Windows, move the pointer to the top of the screen until the control strip appears, and click the close box.
  - or –
  - On Mac, press Command+Q to quit.
- 2 On the VENUE system, deselect Enable in the Ethernet Control section of the Options > Interaction page.

---

## Changing the Ethernet Control Password

You can change the password that users need to enter in order to control your VENUE system from a remote client.

 *By default, the VENUE Ethernet Control password is “password” (all lowercase).*

**To change the Ethernet Control password:**

- 1 In the Ethernet Control section of the Options > Interaction page, double-click the Password field.
- 2 Enter a new password and press Enter.

 *Make a note of the new password and your system’s IP address, as you will need to enter it into the client software.*





# Appendix A: Compliance Information

## Environmental Compliance

### Disposal of Waste Equipment by Users in the European Union



This symbol on the product or its packaging indicates that this product must not be disposed of with other waste. Instead, it is your responsibility to dispose of your waste equipment by handing it over to a designated collection point for the recycling of waste electrical and electronic equipment. The separate collection and recycling of your waste equipment at the time of disposal will help conserve natural resources and ensure that it is recycled in a manner that protects human health and the environment. For more information about where you can drop off your waste equipment for recycling, please contact your local city recycling office or the dealer from whom you purchased the product.

### Proposition 65 Warning

**⚠** *This product contains chemicals, including lead, known to the State of California to cause cancer and birth defects or other reproductive harm. Wash hands after handling.*

### Perchlorate Notice

This product may contain a lithium coin battery. The State of California requires the following disclosure statement: "Perchlorate Material – special handling may apply, See [www.dtsc.ca.gov/hazardouswaste/perchlorate](http://www.dtsc.ca.gov/hazardouswaste/perchlorate)."

### Recycling Notice



## EMC (Electromagnetic Compliance)

Avid declares that this product complies with the following standards regulating emissions and immunity:

- FCC Part 15 Class B
- EN55103-1 E3
- EN55103-2 E3
- AS/NZS CISPR Class B
- CISPR 22 Class B

## FCC Compliance for United States

### Radio and Television Interference

This equipment has been tested and found to comply with the limits for a Class B digital device, pursuant to Part 15 of the FCC Rules.

#### DECLARATION OF CONFORMITY

We, Avid, 2001 Junipero Serra Boulevard  
Daly City, CA 94014-3886, USA  
650-731-6300

declare under our sole responsibility that the product  
VENUE Profile  
complies with Part 15 of FCC Rules.

Operation is subject to the following two conditions:

- (1) this device may not cause harmful interference, and
- (2) this device must accept any interference received, including interference that may cause undesired operation.

#### Communication Statement

NOTE: This equipment has been tested and found to comply with the limits for a Class B digital device, pursuant to Part 15 of the FCC Rules. These limits are designed to provide reasonable protection against harmful interference in a residential installation. This equipment generates, uses, and can radiate radio frequency energy and, if not installed and used in accordance with the instructions, may cause harmful interference to radio communications. However, there is no guarantee that interference will not occur in a particular installation. If this equipment does cause harmful interference to radio or television reception, which can be determined by turning the equipment off and on, the user is encouraged to try and correct the interference by one or more of the following measures:

- Reorient or locate the receiving antenna.
- Increase the separation between the equipment and receiver.
- Connect the equipment into an outlet on a circuit different from that to which the receiver is connected.
- Consult the dealer or an experienced radio/TV technician for help.

Any modifications to the unit, unless expressly approved by Avid, could void the user's authority to operate the equipment.

## Australian Compliance



## Canadian Compliance

This Class B digital apparatus meets all requirements of the Canadian Interference-Causing Equipment Regulations.

Cet appareil numérique de la classe B respecte toutes les exigences du Règlement sur le matériel brouilleur du Canada.

## CE Compliance

### (EMC and Safety)



Avid is authorized to apply the CE (Conformité Européenne) mark on this compliant equipment thereby declaring conformity to EMC Directive 2004/108/EC and Low Voltage Directive 2006/95/EC.

---

## Safety Compliance

### Safety Statement

This equipment has been tested to comply with USA and Canadian safety certification in accordance with the specifications of UL Standards: UL60065 7th /IEC 60065 7th and Canadian CAN/CSA C22.2 60065:03. Avid Inc., has been authorized to apply the appropriate UL & CUL mark on its compliant equipment.

### Warning



### Important Safety Instructions

- 1) Read these instructions.
- 2) Keep these instructions.
- 3) Heed all warnings.
- 4) Follow all instructions.
- 5) Do not use this equipment near water.
- 6) Clean only with dry cloth.
- 7) Do not block any ventilation openings. Install in accordance with the manufacturer's instructions.
- 8) Do not install near any heat sources such as radiators, heat registers, stoves, or other equipment (including amplifiers) that produce heat.
- 9) Do not defeat the safety purpose of the polarized or grounding-type plug. A polarized plug has two blades with one wider than the other. A grounding type plug has two blades and a third grounding prong. The wide blade or the third prong are provided for your safety. If the provided plug does not fit into your outlet, consult an electrician for replacement of the obsolete outlet.
- 10) Protect power cords from being walked on or pinched particularly at plugs, convenience receptacles, and the point where they exit from the equipment.
- 11) Only use attachments/accessories specified by the manufacturer.
- 12) For products that are not rack-mountable: Use only with a cart, stand, tripod, bracket, or table specified by the manufacturer, or sold with the equipment. When a cart is used, use caution when moving the cart/equipment combination to avoid injury from tip-over.

13) Unplug this equipment during lightning storms or when unused for long periods of time.

14) Refer all servicing to qualified service personnel. Servicing is required when the equipment has been damaged in any way, such as power-supply cord or plug is damaged, liquid has been spilled or objects have fallen into the equipment, the equipment has been exposed to rain or moisture, does not operate normally, or has been dropped.

15) For products that are a Mains powered device:

The equipment shall not be exposed to dripping or splashing and no objects filled with liquids (such as vases) shall be placed on the equipment.

**Warning!** To reduce the risk of fire or electric shock, do not expose this equipment to rain or moisture.

16) For products containing a lithium battery:

**CAUTION!** Danger of explosion if battery is incorrectly replaced. Replace only with the same or equivalent type.

17) For products with a power switch:

The main power switch is located on the back panel of the VENUE Profile. It should remain accessible after installation.

18) The equipment shall be used at a maximum ambient temperature of 40° C.

# Index

## Numerics

0 dBVU 165  
1–8 (Bus LED) 31  
2-Track 63  
48V 76

## A

A Unit has gone Offline 240  
Absolute (editing snapshots) 190  
ACS  
    target and channel Select switch 33  
    targeting options 64  
ACS (Assignable Channel Section) 34  
Actions 205  
    creating 209  
    list 216  
ADAT 112  
Add (or Update) this plug-in to Snapshot 165  
AES 112  
AFL 119  
AFL Follows Auxes/Variable Groups 120  
All (snapshots) 179  
AND (Event List) 208  
assembling the mount 11  
Assignable Channel Section (ACS) 34  
attack  
    compressor/limiter 135  
    expander/gate 136  
automation 184  
    and Channel Safe 186  
    see Snapshots  
Automation Safe 65  
auto-save and History 176  
Aux  
    banking 48  
    busses 95  
    configuring busses and Groups 80  
    display in Input LCD 33  
    level and pan via Flip to Faders 98  
Aux Sends  
    snapshot as monitor, or as effects sends 200  
Auxes  
    up to 24 (Var Groups) 95  
Auxes/Variable Groups Follow AFL 120

## B

backup  
    and History 176  
    CD-ROM 241  
Balance 70  
balance (when pasting) 51  
ballistics for meters 65, 118  
bandwidth  
    EQ 144  
Bank A–D 45  
Bank Safe 46  
banking 45, 48  
    Group Spill 90  
    outputs 48  
banner display 39  
bell or shelf EQ 144  
Blank Strip 52  
blue (snapshot) 181  
built-in  
    compressor 135  
    expander 135  
    gate 135  
    limiter 135  
bus assignment indicators 31  
bus processors  
    assigning plug-ins 160  
busses  
    linked Matrix stereo 103  
Busses page 60

bypass  
    EQ in out 143  
bypassing plug-ins 158

## C

C/M  
    LED 31  
Cancel 37  
CD-ROM  
    using for Transfer and Filing 225  
Center Last Recalled Snapshot 182  
Change Target By 64  
channel  
    reset shortcut 51  
Channel Name 33, 65  
channel number (plug-in rack routing) 158  
CHANNEL SAFE 186  
Channel Safe 186  
channels  
    banking 45  
    configuring number of 58  
    copy and paste 51  
    in the Patchbay 111  
    moving 52  
    selecting 48  
    type text search 49  
Chase MTC 181  
Clear 178  
Clear Console  
    during reset 239  
clip  
    Hidden Bank Clip 30  
    Hidden Bank LED 116  
    Hold 118  
    Margin 118  
clock  
    system date and time 63  
clock (tempo) 64  
clock (word) 25  
colors in rack slots 157  
Comp/Lim 137  
compatibility 8  
compressor  
    side-chain 139  
Compressor Threshold 33  
compressor/limiter  
    adjusting 136  
    attack 135  
    comp knee 135  
    defaults 136  
    Dynamics Graph 138  
    gain reduction meters 135  
    make-up gain 135  
    ratio 135  
    release 135  
    threshold 135  
Config Mode 40  
    and plug-ins 151  
Console 40  
Console Mode switch 40  
contact closure 247  
Control Surface Change 237  
copy and paste  
    channel settings 51  
    dynamics settings 139  
    EQ settings 148  
copying  
    plug-ins 159  
Create new snapshot containing this plug-in 165  
crossfade (snapshots) 198  
Cue on Mains Fader 124  
cursor 64

## D

- Date & Time Check 237
- date and time 63
- dBVU, dBu, dBFS 165
- DC (GPI Output) 247
- Default 41
- defaults
  - compressor/limiter 136
- delay
  - compensation 85
  - input channel built-in 77
  - mains (house) 85
  - Monitor bus 60, 124
- delay (Event List Wait) 210
- Delay Compensation 61
- Delete (snapshots) 178
- Devices page 59
- Digital/Analog EQ 143
- DigiTest 239
- Dim
  - Talkback dim 63
- Direct Outs
  - from output busses 85
  - routing to plug-ins 161
- Disable
  - snapshots 178
- divergence 85
- Dly (channel Delay in snapshots) 201
- DSI card (Digital Stage Input) 24
- DSO card (Digital Stage Output) 24
- DSP
  - plug-in allocation tips 58
  - plug-ins 165
- Duplicate 178
- Dyn Pre-EQ 138, 146
- dynamics
  - adjusting 136
  - and plug-ins 138
  - built-in 72
  - bypassing 137
  - comp/lim 136
  - Dynamics Graph 138
  - presets for built-in 139
  - settings and presets 139
  - side-chain 139

## E

- ECx 251
  - installing software 251
- Edit (System Config) 57
- Edit mode 190
- EQ
  - adjusting 144
  - and plug-ins 146
  - bell or shelf 144
  - built-in HPF 143
  - built-in parametric 143
  - bypass via Input Direct mode 138, 146
  - digital/analog 143
  - Dyn Pre-EQ 138, 146
  - GEQ 83
  - in out 143
  - parametric 143
  - ranges of controls 149
  - settings and presets 148
- ethernet (see ECx) 251
- Events
  - actions 205
  - and Preview mode 194
  - and Snapshot modes 211
  - and snapshots 211
  - behavior 210
  - creating actions 209
  - creating triggers 208
  - creating, selecting, managing 206
  - defaults 212
  - enabling and disabling 207
  - Event List 204
  - list of action types and properties 216
  - list of trigger types and properties 215
  - reset 210
  - terminology 203
  - testing 210
  - triggers 205

- Wait 210
  - window 204
- Exp/Gate 137
- expander
  - side-chain 139
- expander/gate
  - adjusting 136
  - attack 136
  - gain reduction meters 136
  - gate range 136
  - release 136
  - threshold 136
- Expert Mode 93

## F

- faders
  - and Group Spill 90
  - Flip 33
  - Flip for Send level and pan 98
  - reset shortcut 51
- FDMI 11
- feedback 211
- Filing
  - History 176
  - loading Shows 172
  - Presets and Scope Sets 173
  - Show files 172
  - Show Folders 171
- filtering with Recall Safe 184
- Fine 42
  - momentary or latching 42
- firmware 242
- Flip 33
  - Send level and pan 98
- Footswitch Status (Events) 205
- formats (plug-ins) 159
- Function switches 131
- Function switches (F1, F2, F3, F4) 37
- FX Returns
  - and plug-ins 160
  - banking 45
  - channel controls 30
  - configuring 58

## G

- gain
  - and multiple input routing 112
  - Guess 32
  - setting 32
- gate
  - key source 140
  - range for expander/gate 136
  - side-chain 139
- Gate Threshold 33
- General Purpose Interface (see GPI)
- global modifiers 41
- GPI
  - Input pinouts 247
  - input specifications 246
  - Output pinouts 248
  - output specifications 247
  - pulse and duration 210
  - Status display (Events) 205
  - wiring diagrams 248
- Graphic EQs 83
  - configuring 58, 147
- green (snapshot) 181
- ground (GPI outputs) 247
- Groups
  - and Variable Groups 80
  - banking 48
  - spill 90
  - using 89
  - Variable Groups 95
- Guess (gain) 32

## H

- hard knee 135
- hardware
  - display of unavailable 110
- headphones
  - level 123
- hexadecimal 195

Hidden Bank Clip 116  
hidden bank clip 30  
high-pass filter 143  
History 176  
house (Mains)  
  mute 129  
HPF 33, 76

## I

I/O  
  unavailable 110  
iLok 153  
  USB ports 153  
In/Out  
  EQ 143  
Input Channels 69  
Input Delay 33  
Input Direct mode 78, 138, 146  
Input Gain 33  
Input Pan 33  
Input Safe Switches  
  changing modes via an Event 212  
inputs  
  20 dB pad 76  
  analog 20  
  assigning Patchbay routing 70  
  assigning to VCAs 72  
  automation safe 187  
  built-in dynamics 72  
  built-in EQ 72  
  channel controls 30  
  connecting digital 25  
  faders 77  
  HPF 76  
  Input Channels and FX Returns 69  
  input channels and FX returns 30  
  Input Direct mode 78, 138, 146  
  make stereo 69  
  mute 77  
  naming 70  
  pan 76  
  phantom power 76  
  polarity (phase) 77  
  routing to Auxes 71  
  routing to Mains and Groups 71  
  Safe 77  
  solo 77  
  width 76  
Insert Blank Strip 52  
Insert Mode 162  
insert number (plug-in rack routing) 158  
inserts  
  assigning plug-ins 160  
  on outputs 82  
Installed Plug-Ins 151  
Interaction page 64  
invert output phase 83

## K

key assign 140  
key listen 140  
key source 140  
knee  
  hard or soft 135  
knobs  
  rotary and switch functionality 32

## L

Latch (Event action behavior) 210  
LCDs  
  options 65  
LCR 58  
levels  
  plug-ins 165  
limiter  
  adjusting 136  
  defaults 136  
  side-chain 139  
linked Matrixes 103  
linking  
  screen and console 39, 64  
Lock (System Lock) 40  
locking snapshots 188

logic (GPI) 246  
LR  
  LED 31

## M

MADI 6  
Main 58  
Mains  
  configuring 58  
  input routing 71  
  linking 84  
maintenance  
  system restore 241  
Make Stereo 69  
  and Blank Strips 52  
Make Stereo/Mono  
  shortcut 52  
make-up gain  
  compressor/limiter 135  
Markers (Pro Tools) and snapshots 196  
Matrix  
  and snapshots 107  
  banking 48  
  controls 106  
  input configuration 103  
  linked stereo 103  
  linking and unlinking inputs 104  
  user inputs 105  
Matrix and PQ Sources 103  
metering 115  
  ACS 116  
  ballistics and options 118  
  channel meters 115  
  Hidden Bank Clip 116  
  output meter settings 117  
  outputs 117  
  Selected Channel 116  
  solo 117  
MIDI  
  adding to snapshots 195  
  and Recall Safe 185  
  in Preview mode 194  
  output Safe 196  
MIDI Snapshot Output Safe 222  
Misc page 63  
Mix (Recall Safe parameters) 187  
Mix Engines 58  
modes (Config versus Show) 40  
Mon (Aux sends and Variable Groups) 200  
Monitor  
  assignable output 122  
  Bus Delay 60  
  Delay 124  
  level 123  
  on Mains fader 124  
monitor mixing 112  
More Options (during resume) 239  
mouse settings 64  
Move Selected Strip Here 52  
moving plug-ins 159  
MTC  
  chase 181  
  configuring options 62  
  Events and Preview mode 194  
  in Preview mode 194  
Multi 41  
Multi-Assign 49  
Multi-Select 41  
Mute  
  channels, Mute Groups and VCAs 130  
  Groups 129  
  input channels 77  
  Mains (house) 129  
  outputs 84, 129  
N  
  name (channel display) 33  
  naming channels 70  
  navigating 45  
  near-field levels 123  
  New 178  
  next (snapshot) 180  
  None (snapshots) 179  
  Notes (snapshots) 183

## O

- offset
  - Right Offset 76
- On (Recall Safe) 185
- One or More Units have Failed 236
- operating modes 40
- Options 57
  - Busses 60
  - Devices 59
  - Interaction 64
  - Misc 63
  - Pickoffs 61
  - Plug-Ins 151
  - Snapshots 62
  - System (configuration) 57
    - viewing angle 65
- OR (Event List) 208
- oscillator 128
  - settings 63
- Other 159
- Output encoders
  - and plug-ins 162
- outputs
  - analog 20
  - and mute 129
  - automation safe 187
  - Auxes 79
  - banking 48
  - configuring 79
  - delay 85
  - divergence 85
  - graphic EQ 83
  - Groups 79
  - Mains 79
  - Matrix 80
  - metering 117
  - mute 84
  - PQ Personal Q 80
  - reassigning in Patchbay 113
  - routing 80
  - using inserts 82
  - Variable Groups 79

## P

- pad 76
- padlock (snapshots) 188
- Pan 76
- pan
  - divergence 85
  - see also Width 76
  - snapshot crossfade 62
  - when pasting 51
- Pan, Balance & Width 198
- panning
  - 3-across-the-front 58
- parameters 107
- parametric EQ 143
- Patchbay
  - displays and indicators 110
  - navigating 111
  - overview 109
  - route multiple via click and drag 111
  - source and destination display 110
  - warning when reassigning 113
- Patching Grid 110
- Peak Hold 118
- Peak mode (metering) 118
- Personal Q 108
- PFL 119
- phantom power 76
- phase (output) 83
- pickoffs 61
  - Dir Outs to plug-ins 161
  - Matrix and PQ 103
- Plug-In Racks are Ready 239
- Plug-In Racks Need Reset 239
- plug-ins 151
  - allocating DSP 58
  - and channel Direct Outs 161
  - and Recall Safe 185
  - and snapshots 164
  - and standalone software 223
  - assigning to rack slots 159
  - Config and Show mode 151

- Dir Out pickoffs 161
- display options 162
- display unavailable and inactive 157
- enabling and disabling 154
- EQ 146
  - in Preview mode 193
  - in/out (bypass) 158
- Insert Mode views 162
- list and menu management 154
- managing 154
- mono, stereo, other 159
- moving and copying 159
- on outputs 82
- on the control surface 161
- on-screen 163
- pinning a view 164
- preset files 164
- rack slots 157, 158
- racks 156
  - re-initializing the racks 239
- routing to and from 160
- snapshot indication (red) 158
- Source switch 162
- targeting 162
- Use Racks 239
  - views 156
- Plug-ins to Install 151
- polarity (input) 77
- polarity (output) 83
- power
  - start up/shut down guidelines 23
- Power Supply Alert 237
- PQ
  - and snapshots 107
  - banking 48
  - controls 106
  - input configuration 103
  - linking and unlinking inputs 104
  - user inputs 105
- Pre (snapshot parameters) 200
- presets
  - dynamics 139
  - EQ 148
  - folders 173
  - for built-in dynamics 139
  - managing 174
  - plug-ins 164
  - Scope Sets 187
  - transferring 175
- Preview mode 191
  - and plug-ins 193
  - and Undo 192
  - capabilities and overview 192
  - MIDI and MTC 194
- previous (snapshot) 180
- Propagate mode 191
- Pulse and Duration (GPI) 210
- Push-Pin (plug-in view) 164

## Q

- Q 144

## R

- rack slots 156
- racks 156, 239
- ratio
  - compressor/limiter 135
- Ready to Resume 238
- Recall 178, 183
  - Next 181
  - Previous 181
  - Safe 184
- Recall Safe 184
  - and MIDI 185
  - and plug-ins 185
  - and Preview mode 193
  - CHANNEL SAFE 186
  - Matrix and PQ 187
  - turning on and off 185
  - using 186
- recovery 239
- red (snapshot) 181
- red plug-in rack 158
- registration 8

- Relative (editing snapshots) 190
- release
  - compressor/limiter 135
  - expander/gate 136
- remote control (ECx) 251
- Remove this plug-in in Snapshot 165
- reset 238
- Reset (strip) 51
- reset a section or parameter 41
- Reset Fader 51
- Reset Mix Engines 239
- resolution (see Fine)
- restart 238
- restore (software) 241
- Resume Operations 238
- right-click shortcuts 51
- RMS mode 118
- rotary encoders
  - rotary and switch functionality 32
- routing
  - assigning channels in the Patchbay 111
  - channel bus indicators 31
  - Monitor bus 122
  - multiple D-Show channels to a hardware output 112

**S**

- Safe
  - Automation 65
  - Recall Safe 184
  - Solo 65
  - using channel automation safe 187
- Safe All 187
- Safe Selected 187
- Sample rate conversion 24
- sample rate conversion 25
- save (History auto-save) 176
- Scope Sets
  - transferring 175
  - using 187
- security (System Lock) 40
- Select
  - channel switch 33
- Selected Chan
  - options 64
- selecting channels 48
- settings
  - dynamics 139
  - EQ 148
  - plug-ins 164
- shelf or bell EQ 144
- shortcuts 41
  - right-click 51
  - Snapshots 181
- Show files 171
  - creating 171
  - deleting 171
  - Folders 171
  - loading 172
  - transferring 175
- Show Folder 171
- Show Mode 40
- Shows
  - and plug-in management while loading 154
- side-chain 139
  - assigning for plug-ins 161
  - assigning source (gate only) 140
- signal routing
  - display in Patchbay 110
  - inputs 70
- Simple Mode 93
- SIP 119
- Snapshots
  - adding MIDI messages 195
  - adding plug-in data 197
  - adding tempo 196
  - All 179
  - and Channel Safe 186
  - and Pro Tools markers 196
  - Center Last Recalled in list 182
  - Channel Safe 186
  - channel scope 178
  - chase MTC 181
  - classifying Auxes and Var Groups 200
  - Clear 178
  - color indication in List 181
  - creating 182
  - crossfade 198
  - data type buttons 178
  - Delete 178
  - Disable 178
  - Duplicate 178
  - Edit mode 190
  - Events and Preview mode 194
  - faders 179
  - from the console 180
  - in Preview mode 192
  - keyboard shortcuts 181
  - List 178
  - list of data types and parameters 201
  - locking and unlocking 188
  - managing (storing, clearing, deleting, moving, duplicating) 188
  - MIDI and plug-ins in Preview mode 192
  - naming and renaming 183
  - New 178
  - Next 180
  - None 179
  - notes 183
  - overview 177
  - pan crossfade 62
  - plug-in menu 164
  - plug-in scope indication 158
  - Preview (editing and previewing snapshots) 191
  - Preview mode F key 131
  - Previous 180
  - Propagate mode (updating snapshot parameters) 191
  - Recall 178
  - Recall Safe 184
  - recalling 183
  - safe filter (Recall Safe) 186
  - Scope Sets 187
  - selecting 181
  - Store 178
  - target 183
  - type text search 49
- Snapshots containing this plug-in 164
- Snapshots page 62
- soft knee 135
- software
  - overview of pages and tabs 43
  - standalone 223
  - system restore 241
  - updating 241
- Solo
  - AFL, PFL, SIP modes 119
  - and key listen 140
  - Cue on Mains Fader 124
  - input channels 77
  - metering 117
  - on-screen settings 61
  - solo safe 121
- Solo Safe 65
- Source 33, 162
- spill
  - Groups 90
  - VCA's 88
- Stage Rack
  - enabling 2 24
- standalone software 223
  - and plug-ins 223
  - export System Info 113
  - installing and removing 223
  - system requirements 223
- stereo
  - spread (Bal/Width) 70
- stereo channels (see Make Stereo) 69
- stereo plug-ins 159
- Store 178
- sync
  - plug-in tempo 64
- synchronizing digital sources 25
- System 57
- system clock 63
- System Config 57
- System Lock 40
- system requirements 8
- System Update and Restore CD 241



## T

- takeover from backup mode 238
- Talkback
  - dim level 63
- Tap Tempo 64, 217
- target
  - channel Select switch 33
  - channels 48
  - plug-in 162
- Targeting Changes View Mode 64
- tempo
  - snapshots 196
- threshold
  - compressor/limiter 135
  - Expander/Gate 136
- time of day 63
- Tool Tips 39
- Trackball
  - settings for 64
- Trackball Mount 12
- transfer 175
- Triggers 205
  - creating 208
  - list 215
- troubleshooting
  - plug-ins 154
  - restore and replace all software 241
- Type Text search 49

## U

- Undo
  - in Preview mode 192
  - via History 176
- Update this plug-in in Snapshot 165
- updating VENUE software 241
- USB
  - ports for iLoks 153
- Use Racks 239
- User 42
- User Inputs (Matrix/PQ) 105

## V

- Variable Groups 95
  - level and pan via Flip to Faders 98
  - snapshot as monitor, or as effects sends 200
- VCAs
  - and snapshots 201
  - assigning 86
  - banking 48
  - mute 129
  - spill 88
  - using 87
- VENUE
  - Standalone software 223
- VENUE Link 196
- VESA 11
- VGA monitor 11
- Video Monitor Mount 11
- voltage 7

## W

- Wait (Event List) 210
- While Active (Event action behavior) 210
- Width 76
- width (when pasting) 51
- wireless (ECx) 251
- word clock 25

## X

- XOR (Event List) 208

## Y

- yellow (snapshot) 181

## Z

- zero
  - see Clear Console





**Avid**  
2001 Junipero Serra Boulevard  
Daly City, CA 94014-3886 USA

**Technical Support (USA)**  
Visit the Online Support Center at  
[www.avid.com/support](http://www.avid.com/support)

**Product Information**  
For company and product information,  
visit us on the web at [www.avid.com](http://www.avid.com)